













# NEW AMERICAN SUPPLEMENT

TO THE LATEST EDITION OF THE

# ENCYCLOPÆDIA BRITANNICA

A STANDARD WORK OF REFERENCE IN

ART, LITERATURE, SCIENCE, HISTORY, GEOGRAPHY,  
COMMERCE, BIOGRAPHY, DISCOVERY  
AND INVENTION

EDITED UNDER THE PERSONAL SUPERVISION OF

DAY OTIS KELLOGG, D.D.

*Formerly Professor of English Literature and History, Kansas State University, etc., etc.*

ASSISTED BY A CORPS OF EXPERIENCED WRITERS

ENRICHED BY MANY HUNDRED SPECIAL ARTICLES CONTRIBUTED BY MEN AND  
WOMEN OF INTERNATIONAL REPUTATION

Illustrated with over Fifteen Hundred Portraits and Other Engravings

TWENTIETH CENTURY EDITION

*REVISED, WITH LARGE ADDITIONS, TO JANUARY 1, 1901*

IN FIVE VOLUMES

VOLUME XXVII

THE WERNER COMPANY

NEW YORK

AKRON, OHIO

CHICAGO

1902

---

COPYRIGHT, 1897  
BY  
THE WERNER COMPANY

---

COPYRIGHT, 1900  
BY  
THE WERNER COMPANY

---

COPYRIGHT, 1901  
BY  
THE WERNER COMPANY

---





# ILLUSTRATIONS

IN THIS VOLUME.



	PAGE
Corn Harvester.....	248
Drill Press.....	669
Fifty-four Inch Radial Drilling Machine.....	668
Gemmæ.....	73
Gordon Statue, London.....	125
Grass-Cutter.....	247
Gunmaking, 9 figures.....	188-97
Gunnery, 1 figure.....	199
Gunpowders, Improvements in, 1 figure.....	199
Harvesting Machinery, 9 figures.....	243-8
Header.....	243
Hussey Machine, 1833.....	245
Iron and Steel, 3 figures.....	404-6
Irrigation, 2 figures.....	415, 418
Karyokinesis, 6 figures.....	480
Kearsarge.....	482
Lathe for Turning and Boring 16-inch Rifles.....	670
Linotype, The Mergenthaler.....	603
Locomotives, 3 figures and diagrams.....	619-20
McCormick Thrust-Machine, 1834.....	244
Machine Tools, 7 figures.....	666-70
Mansion House, London.....	626
Marsh Harvester.....	246
Minute-Man, Lexington Common.....	585
Mowing-Machine.....	247
Parliament, Houses of, London.....	624
Randall Machine, 1833.....	244
Reaper.....	244
Self-Acting Slide-Lathe, Turning and Screw-Cutting Feeds.....	666
Self-Binding Harvester.....	245
Seventy-two Inch Lathe, Screw-Cutting and Turning, with Screw-Feed.....	666
Turret Lathe.....	670
Twelve-Foot Boring and Turning-Mill, with Three Saddles.....	667

## STATE AND TERRITORIAL SEALS

Georgia.....	79
Idaho.....	354
Illinois.....	360
Indiana.....	372
Indian Territory.....	383
Iowa.....	397
Kansas.....	475
Kentucky.....	488
Louisiana.....	634
Maine.....	686

## STATE CAPITOL BUILDINGS

	PAGE
Atlanta, Ga.....	80
Augusta, Me.....	686
Boise City, Idaho.....	355
Des Moines, Iowa.....	399
Indianapolis, Ind.....	373
Little Rock, Ark.....	611
Springfield, Ill.....	362
Tablequah, Cherokee Nation.....	383
Topeka, Kan.....	476

## COLLEGE AND UNIVERSITY BUILDINGS

Franklin and Marshall College, Lancaster, Pa.....	28
General Theological Seminary, New York City.....	75
Girard College, Philadelphia, Pa.....	101
Haverford College, Haverford, Pa.....	253
Indiana University, Bloomington, Ind.....	382
Johns Hopkins University, Baltimore, Md.....	453
Kenyon College, Gambier, Ohio.....	490
Lafayette College, Easton, Pa.....	535
Leland Stanford University, Palo Alto, Cal.....	574
University of Georgia, Athens, Ga.....	82
University of Illinois, Urbana, Ill.....	363
University of Kansas, Lawrence, Kan.....	478

## MAP

Hawaii.....	256
-------------	-----

## PORTRAITS

Forrest, Edwin.....	8
Foss, Cyrus Davis.....	13
Foster, Charles.....	14
Foster, John W.....	15
Foster, Randolph Sinks.....	16
Francis, David R.....	23
Francis Joseph I, Emperor of Austria.....	24
Franklin, General William B.....	27
Frederick III, King of Prussia.....	39
Freeman, Edward A.....	33
Frémont, John C.....	36
French, Daniel C.....	37
Freycinet, Charles Louis de Saules de.....	49
Froude, James A.....	44
Fuller, Melville W.....	49
Furness, Horace H.....	50
Gage, Lyman J.....	53
Gambetta, Léon.....	59
Garcia, Calixto.....	63

	PAGE		PAGE
Gardini, Etelka (Gerster).....	64	Hearn, Lafcadio.....	264
Garfield, James A.....	65	Hecker, Isaac T.....	265
Garibaldi, Guiseppe.....	66	Helmholtz, Hermann L. F. von.....	270
Geary, General John White.....	71	Hendricks, Thomas A.....	271
Geikie, Sir Archibald.....	72	Herkomer, Hubert.....	280
George I, King of Greece.....	78	Hewitt, Abram S.....	284
George, Henry.....	78	Higginson, Thomas W.....	287
Gérôme, Jean L.....	88	Hill, David B.....	289
Gherardi, Admiral Bancroft.....	91	Hirsch, Maurice, Baron de.....	295
Gibbons, Cardinal James.....	92	Hoar, George F.....	297
Gibson, Charles Dana.....	93	Hobart, Garret A.....	297
Giddings, Joshua R.....	94	Hohenlohe, Prince.....	301
Gilbert, William S.....	95	Holland, Dr. Josiah G.....	303
Gilder, Richard Watson.....	96	Holmes, Oliver W.....	305
Gildersleeve, Basil L.....	96	Homer, Winslow.....	309
Gillmore, Quincy A.....	98	Hood, General John B.....	317
Gilman, Daniel Coit.....	98	Hopkins, Johns.....	319
Gladstone, William Ewart.....	103	Hopkins, Mark.....	319
Godkin, Edwin L.....	113	Hosmer, Harriet G.....	325
Goldsborough, Admiral Louis M.....	119	Houghton, Henry O.....	327
Goldschmidt, Madame (Jenny Lind).....	120	Howard, General Oliver O.....	330
Gomez, Máximo.....	121	Howe, Julia Ward.....	331
Gompers, Samuel.....	121	Howells, William D.....	331
Gordon, John B.....	127	Hughes, Thomas.....	336
Gorman, Arthur P.....	128	Hugo, Victor.....	336
Gosse, Edmund William.....	130	Humbert I, King of Italy.....	339
Gough, John B.....	131	Humphreys, General Andrew A.....	340
Gould, Jay.....	132	Hunt, William Henry.....	341
Gounod, Charles F.....	132	Huntington, Frederick D.....	343
Grady, Henry W.....	135	Hurst, John Fletcher.....	345
Grant, General Ulysses S.....	142	Hutton, Laurence.....	345
Granville, Earl.....	145	Huxley, Thomas H.....	346
Gray, Asa.....	147	Ibsen, Henrik.....	352
Greely, General Adolphus W.....	162	Ingelow, Jean.....	387
Green, John R.....	163	Ingersoll, Robert G.....	388
Greene, Nathaniel.....	166	Inness, George.....	390
Gresham, Walter Q.....	170	Ireland, Archbishop John.....	401
Grévy, François P. J.....	171	Irving, Sir Henry.....	422
Gross, Samuel D.....	176	Isabella II, ex-Queen of Spain.....	423
Grow, Galusha A.....	177	Ismail Pasha, ex-Khedive of Egypt.....	424
Guerbel, Countess ("Genevieve Ward").....	182	Jackson, Helen Maria (Fiske).....	432
Haeckel, Ernst H.....	209	James, Henry, Jr.....	436
Haggard, Henry Rider.....	210	James, Thomas L.....	437
Hale, Edward Everett.....	212	Jameson, Leander S.....	438
Halévy, Ludovic.....	214	Jefferies, John R.....	444
Hall, Rev. John.....	216	Jefferson, Joseph.....	445
Halsted, Murat.....	218	Jerome, Jerome K.....	447
Hamerton, Philip G.....	219	Jewett, Sarah Orne.....	451
Hamlin, Hannibal.....	221	Joachim, Joseph.....	451
Hammond, John Hayes.....	222	Johnson, Reverdy.....	455
Hampton, Wade.....	223	Johnston, General Joseph E.....	457
Hancock, General Winfield Scott.....	224	Johnston, Richard M.....	458
Harcourt, Sir William.....	229	Joinville, Prince de.....	459
Hardy, Thomas.....	230	Jowett, Benjamin.....	463
Harper, William Rainey.....	235	Judge, William Q.....	468
Harraden, Beatrice.....	235	Kearney, General Philip.....	482
Harris, Joel Chandler.....	236	Kelvin, Lord.....	484
Harrison, Benjamin.....	237	Kemble, Frances A.....	485
Harrison, Mrs. Burton.....	238	Kennan, George.....	486
Harte, Francis Bret.....	240	Kipling, Rudyard.....	500
Hawkins, Anthony Hope.....	258	Kitchener, Lord.....	505
Hawley, Joseph R.....	259	Knox, General Henry.....	513
Hawthorne, Julian.....	259	Knox, John J.....	513
Hayes, Rutherford B.....	261	Koch, Dr. Robert.....	514

# ILLUSTRATIONS

	PAGE		PAGE
Kossuth, Louis.....	517	Logan, General John Alexander.....	623
Krüger, Stephanus J. P.....	519	Longstreet, General James.....	629
Krupp, Alfred.....	521	Lorne, Marquis of (now Duke of Argyll).....	631
Labouchere, Henry.....	531	Louis I, late King of Portugal.....	633
Lamar, Lucius Q. C.....	538	Louis II, King of Bavaria.....	633
Lamont, Daniel Scott.....	540	Low, Seth.....	637
Lang, Andrew.....	543	Low, William Hicock.....	637
Lanier, Sidney.....	545	Lowell, James Russell.....	638
Larcom, Lucy.....	548	Lubbock, Sir John.....	640
Lathrop, George Parsons.....	549	Lyon, General Nathaniel.....	651
Laurier, Sir Wilfrid.....	555	McCabe, Rev. Charles C.....	655
Lawton, Major-General H. W.....	560	McCarthy, Justin.....	656
Lecky, William E. H.....	564	McClellan, General George B.....	656
Le Conte, Joseph.....	565	McCloskey, Cardinal John.....	657
Lee, Major-General Fitzhugh.....	567	McCook, General Alexander M.....	658
Leidy, Joseph.....	573	McCosh, James.....	660
Leighton, Lord.....	573	McCulloch, Hugh.....	660
Leland, Charles G.....	574	Macdonald, George.....	661
Leo XIII, Pope.....	577	Macdonald, Sir John A.....	661
Leopold II, King of Belgium.....	578	McDowell, General Irvin.....	663
Lesseps, Ferdinand, Viscount de.....	580	McGlynn, Edward.....	665
Lewis, James.....	583	Mackenzie, Sir Morell.....	672
Li Hung Chang.....	599	McKinley, William.....	673
Lincoln, Robert T.....	601	MacMahon, Marshal.....	675
Liszt, Franz.....	609	McPherson, General James B.....	678
Lobanoff, Prince.....	614	Mahan, Captain Alfred T.....	684
Locke, David R.....	617	Mahone, General William.....	685

# CONTRIBUTIONS FROM SPECIAL WRITERS

IN THIS VOLUME.

## FURNACES.

GENERATOR, NEW THERMOELECTRIC.

GLASS.

HÆMOCYTOTOMETER.

HYDRAULIC MACHINERY.

ICE-CUTTING TOOLS.

ICE-MACHINE.

ILLUMINATING APPARATUS.

JACKS.

LAUNDRY MACHINERY.

LIFE-SAVING APPARATUS.

LOCKING-MECHANISMS FOR RAILWAY SWITCHES.

LOOM.

LUBRICATOR.

CHARLES HENRY COCHRANE, M. E., author of *Artistic Homes, and How to Decorate Them*; *The Wonders of Modern Mechanism* (1896); etc.

## GAME-LAWS.

IRRIGATION.

HENRY F. GRIERSON (Capt.), Specialist in Irrigation, etc., Rochester, N. Y.

## FRANCE.

GALVESTON INUNDATION.

GERMANY.

GLADSTONE, WILLIAM EWART.

GOLD COAST.

HAGUE PEACE CONFERENCE.

HOLMES, OLIVER WENDELL.

HUGO, VICTOR MARIE.

HUNT, WILLIAM HOLMAN.

INDIAN FAMINE.

KIMBERLEY, SIEGE OF.

LADYSMITH, SIEGE OF.

LOWELL, JAMES RUSSELL.

LYNCHINGS AND MOB RULE.

MACDONALD, SIR JOHN ALEXANDER.

G. MERCER ADAM, late Editor of *Self Culture*, Akron, O.

## GOLD AND GOLD-MINING.

JOHN F. CARGILL, formerly United States Deputy Mineral Surveyor; author of *A Freak in Finance*, etc.

## GRAMOPHONE.

IDEALISM.

LAW-AND-ORDER SOCIETIES.

LINOTYPE.

LUTHERAN CHURCH IN THE UNITED STATES.

DAY OTIS KELLOGG, D. D., Editor of New Supplements to the ninth edition of the *ENCYCLOPÆDIA BRITANNICA*; formerly Professor of English Literature and History, Kansas State University.

## GUNMAKING.

GUNNERY.

GUNPOWDERS, IMPROVEMENTS IN.

{ D. W. FLAGLER (Brig.-Gen.), Chief of Ordnance, Washington, D. C.  
{ CHARLES H. CLARK (Capt.), Assistant Ordnance Officer, War Department, Washington, D. C.

## HARVESTING-MACHINERY.

JOHN F. STEWARD, Deering Harvester Company.

## HOLY GHOST.

FRANKLIN JOHNSON, D. D., Professor, Divinity Department, University of Chicago.

## HORSE RACING.

J. H. S. JOHNSTONE, Editor *The Horseman*.

## INDIAN AFFAIRS IN THE UNITED STATES.

FRANCIS E. LEUPP, Board of Indian Commissioners, Department of the Interior, Washington, D. C.

## INDUSTRIAL CONDITION OF WOMEN.

ELLEN M. HENROTIN, President General Federation of Women's Clubs.

## INTERSTATE COMMERCE LAWS.

JOHN P. MEANY, Editor *Poor's Manual of Railroads*, New York.

## IRON AND STEEL.

ROSSITER W. RAYMOND, Ph. D., Mining Engineer and Metallurgist; Secretary of the American Institute of Mining Engineers, New York.

## ISOPATHY.

J. THOMAS KELLEY, JR., M. D., Washington, D. C.

## JUDAISM AND THE JEWS IN THE UNITED STATES.

EMIL G. HIRSCH, D. D., Professor of Semitic Languages in the University of Chicago; Rabbi Sinai Congregation, Chicago; member Board of Directors Chicago Public Library; etc.

## LABOR ORGANIZATIONS.

CARROLL D. WRIGHT, LL. D., United States Commissioner of Labor, Washington, D. C.

## LABOR PARTIES.

JOHN BACH MCMASTER, C. E., Ph. D., Professor of American History, University of Pennsylvania; author of *A History of the People of the United States from the Revolution to the Civil War*, etc.

## LIFE INSURANCE IN THE UNITED STATES.

SHEPPARD HOMANS, Consulting Actuary; First President Actuarial Society of America, and Corresponding Secretary, London Institute of Actuaries, New York.

## LOCOMOTIVE.

MACHINE TOOLS.

R. H. THURSTON, LL. D., Director of Sibley College, and Professor of Mechanical Engineering, Cornell University.

## MAGAZINES, AMERICAN.

CARL A. DANIELL, Editor *Presto*, Chicago, Ill.

# F

## FOREIGN JUDGMENT—FORESTRY

**FOREIGN JUDGMENT**, in the United States, a judgment rendered by a tribunal of another nation, or another state of the United States. Such judgments may be proved by producing an exemplified copy of the record of the court, showing the proceedings in the suit in which the judgment was rendered. Judgment in one state may be evidenced in the courts of another state by producing a copy of the proceedings, attested by the clerk and seal of the court wherein the judgment was rendered, together with the certificate of the judge or chief justice of said court that the certificate of the clerk is authentic. The certificate of the judge must be further authenticated by the clerk, who shall certify that such judge was, at the time of making the certificate, duly commissioned and qualified. Transcripts of records thus exemplified must, under the laws of the United States, have such faith and credit given to them in every court and office within the United States as they would have by law in the courts of the state wherein the judgment was rendered. By the constitution of the United States it is provided that full faith and credit shall be given in every state to the judicial proceedings of the courts of another state. Congress may fix the method of proving such proceedings.

**FOREIGN LAWS** include the laws of foreign nations, and in the United States, to a limited extent, the laws of another state. Courts will not take judicial notice of foreign laws, and such laws must be proven in some proper manner, in order to give them effect outside of the jurisdiction in which they are in force. The decisions of the courts of the various states are somewhat in conflict as to how far the courts will take judicial notice of the laws of another state. The general rule would seem to be, that the statutes of another state must be proven, and, in the absence of any evidence as to the laws of that state, the common law will be presumed to prevail.

**FOREKNOWLEDGE AND FOREORDINATION.** See **PREDESTINATION**, Vol. XIX, pp. 668-671.

**FORESTALLING.** See **AGRICULTURE**, Vol. I, p. 298, and **CORN LAWS**, Vol. VI, p. 412.

**FOREST CITY**, a town and the capital of Winnebago County, central northern Iowa, on the Burlington, Cedar Rapids and Northern and the Minneapolis and St. Louis railroads, and on Lime Creek. It is the trade center of a farming district, and it has banks, churches and newspapers. Population 1900, 1,758.

**FORESTERS, ANCIENT ORDER OF.** See **BENEFIT SOCIETIES**, in these Supplements.

**FOREST-FLY OR HORSE-TICK**, a name given to dipterous insects of the genus *Hippobosca*. These insects are parasitic on horses and cattle.

The insects of the family to which the forest-flies belong are remarkable for their peculiar mode of development. Unlike all other insects, the embryonic and larval stages are passed within the oviducts of the mother. Each female produces but one or two larvæ, which transform to pupæ immediately after birth.

**FOREST GROVE**, a town of Washington County, northwestern Oregon, on Gale's Creek, and on the Southern Pacific railroad, 21 miles W. of Portland. The Pacific University is situated here, and Tualatin (Congregational) Academy. The country has fertile farms, the produce of which go to a canning factory and the grain-elevators of the town. Population 1900, 1,096.

**FOREST OAK**, a name sometimes given in commerce to the timber of *Casuarina torulosa* and other species of *Casuarina*, Australian trees. This timber, which is a light yellowish brown, and prettily marked with short red veins, is used for ornamental work.

**FORESTRY.** The forest area in the United States is, according to a careful estimate made by the chief of the forestry division, United States Department of Agriculture, but little less than 500,000,000 acres. The present annual requirements of forest products in the United States are, approximately, over 24,000,000,000 cubic feet, made up of the following items: Lumber market and manufactures, 5,000,000,000 cubic feet; railroad construction, 100,000,000 cubic feet; wood pulp, 150,000,000 cubic feet; fences, 500,000,000 cubic feet; fuel, 136,718,750 cords; mining timber, 155,000,000 cubic feet. In addition to these items of consumption, forest fires annually destroy the products of hundreds of thousands of acres of forest. At the present rate of destruction, therefore, the remainder of forest lands in the United States cannot long meet the enormous demands on its resources. Some of the most important timbers are already practically extinct; the merchantable white pine of the Northwest and of New England will soon all be cut, while of the long-leaf pine of the South only about 1,500,000,000 cubic feet remain. Various measures for the preservation of the forests have been adopted. In 1885 the state of New York instituted a forest commission, with extensive powers, now, however, much curtailed in its functions. Colorado and New Hampshire have also created forest commissions, while Ohio, Kansas and Pennsylvania have forestry bureaus. For several years a national organization, known as the American Forestry Association, composed of delegates from each of the states, has met annually, the fifteenth annual meeting having been held at Washington, District of Columbia, in December, 1896. In 1872 Congress passed a law, known as

the Timber Culture Act, by the terms of which 160 acres of the public domain could be acquired on the cultivation of ten acres of trees thereon for eight years. After remaining in force for 21 years, and resulting in the entry of almost 50,000,000 acres, this law was repealed.

In 1874 the Nebraska State Board of Agriculture recommended that the second Wednesday of April in each year be designated as a day to be dedicated to the planting of trees. The suggestion was adopted, and now no less than 44 states and territories have made similar provision,—21 by act of legislature, 6 as legal holidays, 5 as holidays for schools. They are as follows: Alabama, Arizona, California, Colorado, Connecticut, Florida, Georgia, Idaho, Illinois, Indiana, Iowa, Kansas, Kentucky, Louisiana, Maine, Maryland, Massachusetts, Michigan, Minnesota, Mississippi, Montana, Missouri, Nebraska, Nevada, New Hampshire, New Jersey, New Mexico, New York, North Carolina, North Dakota, Ohio, Oklahoma, Oregon, Pennsylvania, Rhode Island, South Dakota, Tennessee, Texas, Utah, Vermont, Virginia, West Virginia, Wisconsin, Wyoming. Arbor day is a legal holiday in Kansas, North Dakota, Rhode Island and Wyoming, the day being set by the governor; in Nebraska, April 22d; California, September 9th; Colorado, on the third Friday in April; Montana, third Tuesday in April; Utah, first Saturday in April; and Idaho, on Friday after May 1st.

The interest in this annual observance has been intensified by inviting pupils of public schools to take part in its celebration.

That forests have no influence on the rainfall seems to be well settled. A series of experiments conducted in France under the most favorable conditions for arriving at the truth of the matter decided a question that has been debated by scientists for many years. But while forests may not increase the rainfall of a region, it is a fact that they exert a great influence on the distribution, or "run-off," of the available water-supply. There are two methods of distribution, or run-off; namely, the superficial or surface run-off, and the underground run-off, resulting in springs, which eventually change into open runs, brooks and rivers.

As soon as the soil-cover and upper soil strata are saturated, or especially when the latter are impermeable and the rain continues, either no water, or only a small part, gradually can find entrance into the soil, and the run-off becomes superficial, or if the ground be not sloping, stagnant water results. For every forest there is, therefore, a time when the superficial run-off would be no more impeded than from an open field of similar conditions but for the retardation by the trunks, underbrush and roots. This time, however, occurs later in the forest than on the unforested and especially naked soil, because the water-capacity of the soil-cover, as well as of the protected soil, is greater than that of the naked soil, or that covered with field crops.

Since the forest-cover has a tendency to pre-

serve the granular porous structure of the soil, which is favorable to filtration, and as, moreover, the roots furnish channels for unimpeded drainage, it must have the tendency, other things being equal, to allow a more rapid filtration than the naked, mostly compacted soil.

With regard to the superficial run-off, without any evidence furnished by experiments, we can at once understand that it is impeded by any kind of mechanical obstruction, such as is offered by the vegetation of a meadow or forest. The great number of inequalities which the forest floor offers, in addition to the trunks and stumps and fallen trees, subjects the run-off to many detours, thus retarding its flow and its collection in the open runs and brooks. This retardation is increased by the mechanical obstruction which the crowns of the trees exert upon the rainfall. Every leaf, every twig, breaks the force and retards the fall of the raindrops, allowing those fallen before to penetrate the soil. The devious ways in which it reaches the soil make the flow of water from a forest-covered hill longer in time than if the rain had fallen on a bare slope. This mechanical effect is further favorable to the penetration of water into the soil, as it prevents the rain from compacting the soil, preserving thereby its mellow condition, which is destroyed on the open field by the force of the raindrops. It also allows more time for the absorption of water by the soil. There is, in fact, no influence of the forest of more moment in the distribution of the available water supplies than the mechanical retardation of the "run-off," while in the conservation of supplies the retarding influence upon evaporation is the potent one.

The umbrageous character of forest areas prevents the rapid evaporation that takes place in the open, and the restraint of the otherwise rapid run-off of rainfall prevents freshets, and preserves the equable gauge of adjacent streams. The removal of large areas of forests has resulted in the rainfall rapidly reaching the natural drainage channels, causing floods in streams that reach the other extreme in periods of dry weather for lack of the steady supply before afforded.

FOREY, ELIE FRÉDÉRIC, a French marshal; born at Paris, Jan. 10, 1804; died at Besançon, June 20, 1872. He was educated at Dijon; graduated from the military school at St.-Cyr in 1822; and was engaged in the Algerine campaigns of 1830, 1835 and 1840, returning to France a colonel. He took an active part in the *coup d'état* of December, 1851, and was made general of division and commander of the Legion of Honor in 1852. In the war with Russia he was for a short time in command of the French forces before Sebastopol, and during the Italian war in 1859 defeated the Austrians at the battle of Monte Alpo. General Forey commanded the French expedition against Mexico, captured the city of Puebla, May 17, 1863, and entered the capital June 10th. For these successes he was made a marshal. On his return to France he had command of an army corps and of the camp of

Chalons. He was a Senator, and was decorated with the grand cross of the Legion of Honor in 1867.

**FORFEITURE**, the act of depriving a person of property by reason of some illegal act or negligence. Forfeiture for crime is almost entirely abolished in the United States by the constitution and acts of Congress, and when it is permitted, as in the case of treason, only the owner's life estate in the property will be forfeited. The most frequent occurrence of forfeiture is for failure to perform some condition contained in a deed of conveyance or implied by the law. Forfeitures, as a rule, are not favored by the law, and strict proof is necessary.

**FORFICULIDÆ**. See **EARWIGS**, Vol. VII, p. 613; and **INSECTS**, Vol. XIII, p. 152.

**FORKED-BEARD**, a popular name applied to European fishes of the cod family, belonging to the genus *Phycis*. The name refers to the forked ventral fins. In United States waters they are known as "hake," but as food-fish they are superior to the true hake.

**FORMAL CATEGORIES**. See **PSYCHOLOGY**, Vol. XX, p. 80.

**FORMALIN OR FORMOL**. Under this name a forty-per-cent solution of formaldehyde ( $\text{CH}_2\text{O}$ ) has recently been put on the market for use in preserving specimens, such as parts of animals and whole animals, in biological work. It is diluted to one fourth per cent, according to the use to which it is to be put. It is equal to alcohol as a preservative, and very much superior to it in its power of retaining the color and form of specimens.

**FORMAN, HARRY BUXTON**, a British writer; born in London, July 11, 1842. He entered the service of the postal department, and became the assistant secretary and controller of packet services. It is on account of his literary productions that he is known to English-speaking people. His writings and editions of Shelley and Keats are of the highest order. He published, in addition to *Essays on Shelley*, the Library edition of *The Poetical Works of Percy Bysshe Shelley* (1882), the *Prose Works of Shelley* (1880), and editions of several single works of Shelley. Of Keats, he has published *Works of John Keats in Verse and Prose* (1882); *Letters of John Keats to Fanny Brawne* (1878); and *Poetry and Prose by John Keats* (1890). He was a constant contributor to the best periodicals of the day. Among his miscellaneous editions are *Golp: A Dialogue*, by John Ruskin (1891), and *Joseph and His Brethren*, by Charles Wells (1876).

**FORMES, KARL JOHANN**, a German singer; born in Mülheim-am-Rhein, Aug. 7, 1810. He appeared in various operas in Vienna, Hamburg, and London, and gained a reputation as a bass singer of unequalled talent. In 1857 he came to the United States, and appeared with much success in the principal cities of the Union. He visited England again in 1888, and sang at Mr. Mann's benefit concert, April 21, and elsewhere. Died in San Francisco, Cal., Dec. 15, 1889.

**FORMIC ACID** ( $\text{CH}_2\text{O}^2$ ), derives its name from the circumstance of its having been first obtained from the *formica rufa*, or red ant. In a concentrated state, it is a fuming liquor with an irritating odor, and occasions vesication if dropped upon the skin. It crystallizes at  $47^\circ$  and boils at about  $213^\circ$ , yielding a vapor which burns with a blue flame. It is a strong reducing agent, at a boiling temperature reducing the salts of silver, mercury, platinum and gold.

**FORMOSA**, an island off the southeast coast of China; area, 13,541 sq. miles; pop. 1897, 2,728,817. See **FORMOSA**, Vol. IX, p. 415. During the Franco-Chinese war of 1885, when the French, after capturing Kelung, endeavored to conquer the island, the capital was removed to Tai-pak-fu, part of the city of Twatutia, connected with Kelung by rail. In the treaty of May 4, 1895, Formosa was ceded to Japan, together with the Pescadores Islands. Since then the "Black Flags" have risen repeatedly in revolt against those whom they naturally regard as foreign usurpers. On Feb. 1, 1896, Japan formally opened the island to foreign commerce with all powers having commercial treaties with Japan.

**FORMS OF ADDRESS**. See **ADDRESS, FORMS OF**, in these Supplements.

**FORNEY, JOHN WEISS**, an American journalist and politician; born at Lancaster, Pennsylvania, Sept. 30, 1817; was apprenticed to a printer in Lancaster, Pennsylvania, 1833. In 1840 he published *The Intelligencer and Journal* of that city, a Democratic paper; in 1845 became surveyor of the port of Philadelphia, and was editor of *The Pennsylvanian*, published in Philadelphia. From 1851 to 1855 he was clerk of the House of Representatives, and in 1856 was elected chairman of the Pennsylvania Democratic State Committee. In 1859 he was again chosen clerk of the House of Representatives, and in 1861 became secretary of the United States Senate. In 1871-72 he became collector of the port of Philadelphia. He was editor of the *Washington Union* in 1851; of the *Philadelphia Press* in 1857; of the *Washington Chronicle* in 1859; and in 1879 of *Progress*, a weekly journal published in Philadelphia, where he died, Dec. 9, 1881.

**FORRES**, a royal burgh of Elginshire, on the river Findhorn, northeastern Scotland, 5 miles S. of Moray Firth, and 25 E.N.E. of Inverness, with which and Nairn and Fortrose it returns a member to Parliament. On its Castle Hill, a royal residence from 1189 to 1371, stands an obelisk (1857) 65 feet high, to the Crimean hero, Dr. Thomson of Cromarty, while on the wooded Cleeny Hill are a hydropathic establishment, and the Nelson Tower (1806), 70 feet high. Sueno's Stone is a remarkable sculptured monolith, ascribed by Skene to the year 900; the Witch's Stone recalls Macbeth's meeting with the weird sisters near Forres. Public buildings are the Town House, Falconer Museum, Mechanics' Institute and Anderson's Institution. Population, 1891, 3,975.

**FORREST, ALEXANDER**, an Australian explorer; born at Bunbury, Australia, Sept. 22,

1849. After taking part with his brother John in his journeys, in 1879, he started with Hill to explore the northwestern parts of the Australian continent, an expedition which resulted in the discovery of the fertile pastoral region now called Kimberley District. At the same time the river Fitzroy was ascended for a distance of about 250 miles. This journey was described in *Journal of an Expedition from the De Grey to Port Darwin* (1880).

FORREST, EDWIN, an American tragedian; born in Philadelphia, March 9, 1806; died there



EDWIN FORREST.

Dec. 12, 1872. He made his theatrical *début* as Douglas in Home's tragedy of that name, and then made a professional tour through the Western and Southwestern states. In November, 1826, he played a star engagement at the New York Bowery Theater, commencing in the character of Othello, which was pronounced a signal success. This was followed by other parts acted with no less ability. He left New York a prominent tragedian and a great favorite, to repeat his dramatic triumph in other cities of the Union. After playing for several years, he visited Europe for recreation and study. He returned to the United States in 1831, and continued playing with unabated attraction until the autumn of 1836, when he again sailed for Europe. His first appearance in England was as Spartacus in the *Gladiator*, which was followed by *Macbeth*, *Lear* and *Othello*. In London he married a daughter of John Sinclair, the popular Scottish ballad-singer, and in November of the same year began an engagement in Philadelphia. In 1845, in company with his wife, he again visited London and performed at the Princess's Theatre. Much professional jealousy arose between Forrest and Macready, the favorite tragedian of the British stage, which led to open outbreaks of temper, in consequence of which the American actor lost favor with the British public. In May, 1849, when Macready was playing *Macbeth* at the Astor Place Opera House, New York City, a riot ensued. On this occasion twenty rioters were killed and thirty-six wounded. The actor's marriage with his English wife proved an unhappy one; divorce suits were brought on both sides, that occupied the courts for several years, and were finally decided in the wife's favor. In 1853 Forrest performed at the Broadway Theater for several weeks. In 1865 he became gouty, and one of his arms was slightly paralyzed. Forrest's trip to California in 1866 was unsuccessful. His last theatrical appearance was made at Boston in March, 1871, when he broke down during the engagement. Later, he endeavored to give readings from Shakespeare's plays, but they failed to attract. He had acquired a large fortune, which was estimated, at his death, as amounting to \$1,000,000. He built

a mansion in castellated style on the banks of the Hudson, which was a conspicuous object from the river. He also erected an imposing house in Philadelphia. The Hudson mansion became afterward a convent, and the Philadelphia house a school of design. He had collected a library rich in Shakespeariana, which was destroyed by fire soon after his death. His fortune he left chiefly for the purpose of founding a home for poor and indigent members of his own profession.

FORREST, JOHN, an Australian explorer; born in Western Australia in 1847; entered the Survey Department of Western Australia in 1865, and in 1869 commanded an exploring expedition into the interior in search of Dr. Leichhart and party. In 1870 he commanded an exploring expedition from Perth to Adelaide along the south coast, and proved the practicability of the country for a telegraph line, which was constructed in 1876. In 1874 he commanded an exploring expedition from Champion Bay, on the west coast of Australia, to the overland telegraph line between Adelaide and Port Darwin, without the aid of camels, with horses only, a journey of nearly 2,000 miles. For these services he received the thanks of the governor and the legislative council, and was awarded the gold medal of the Royal Geographical Society of London, May 22, 1876, and was also presented by the imperial government with a grant, in fee, of 5,000 acres of land. He was a member of the executive and legislative councils of the colony; and represented Western Australia at the colonial conference in London, 1887. He published *Explorations in Australia* (1876) and *Notes on Western Australia* (1883, 1884 and 1885).

FORREST, NATHAN BEDFORD, an American soldier; born in Bedford County, Tennessee, July 13, 1821; died at Memphis, Oct. 29, 1877. He became a planter and afterward a slave-dealer; in June, 1861, he raised a cavalry regiment for the Confederacy, and was engaged at Fort Donelson, Shiloh, Murfreesboro and Chickamauga. Becoming a major-general, he commanded at the attack on Fort Pillow, in April, 1864; the works were taken by assault, and the colored troops of the garrison mercilessly slaughtered, no quarter being given. He was promoted lieutenant-general. Gen. J. H. Wilson defeated him in April, 1865, and he surrendered at Gainesville a month later. After the war he engaged in the railroad business.

FORREST CITY, a town and the capital of St. Francis County, eastern Arkansas, 45 miles W. of Memphis, Tennessee, on the Little Rock and Memphis and St. Louis, Iron Mountain and Southern railroads. It has a large canning factory, and ships farm produce and stock. Population 1890, 1,021; 1900, 1,301.

FORRESTER, ALFRED HENRY, better known as "Alfred Crowquill," an English humorist and artist; born in London in 1806; notary public in the Royal Exchange, where the family had been engaged in the same profession for over a century. He began to publish in the magazines when he was only fifteen years of age, and before he had completed his twentieth year had made considerable



progress in drawing, pursuing his artistic studies with the object of illustrating his own works. He published *Leaves from My Memorandum Book*, consisting of selections of his own comic prose and verse, illustrated by himself; and *Eccentric Tales*. He joined the staff of *Colburn's Magazine* in 1828, in which he was associated with the most brilliant wits of the time. He next became connected with *Bentley's Miscellany*, and was the first illustrator of *Punch* and *The Illustrated London News*. He exhibited large pen-and-ink drawings at the Royal Academy; painted in oil; was also a designer and modeler, a specimen of his ability in the latter art being his statuette of the Duke of Wellington, produced a week before the Iron Duke's death. His works include *The Wanderings of a Pen and Pencil*; *Comic English Grammar*; *Comic Arithmetic*; *Phantasmagoria of Fun*; *Bentley Fun*; *A Bundle of Crowquills*; *Magic and Meaning It*; *Railway Raillery*; *St. George and the Dragon*; *Gold: A Poem*; *Absurdities*; *Reproof of the Brutes*. He died in London, May 26, 1872.

FORRESTON, a village of Ogle County, northern Illinois, 95 miles W. of Chicago, on the Chicago, Burlington and Quincy and Illinois Central railroads. Butter and cheese making, farming and shipping are the industries of the neighborhood. Population 1890, 1,118; 1900, 1,407.

FORSHEY, CALEB GOLDSMITH, an American engineer; born in Somerset County, Pennsylvania, July 18, 1812; studied at West Point; became an engineer, and was appointed professor of mathematics and civil-engineering at Jefferson College, Mississippi. He had charge of government surveys in Mississippi and Texas, and was actively engaged in railroad construction for many years. During the Civil War he served on the staff of General Magruder as chief engineer. After the close of hostilities, he re-engaged in railway work, and contributed extensively to technical journals. He died at Carrollton, Louisiana, July 25, 1881.

FÖRSTER, ERNST JOACHIM, a German painter and art-writer; born in Münchengossenstadt, Bavaria, April 8, 1800. He studied theology and philosophy in the universities of Berlin and Jena, but in 1822 abandoned these to devote himself to painting under the instruction of Cornelius. He executed various fresco-pieces in Bonn and Munich. In 1826 he visited Italy and commenced researches in art history, which he subsequently pursued in Germany, France, Belgium and England. The results of his studies are embodied in the publications, *Letters on Painting* (1838); *History of German Art* (5 vols., 1851-60); *Monuments of German Architecture, Sculpture and Painting* (12 vols., 1853-69); biographies of Fra Angelico, J. G. Müller, Raphael and Cornelius. At the time of his death he left two large works unfinished, *A History of Italian Art* and *Monuments of Italian Painting*. In his researches in Italy he discovered several ancient pictures, notably frescoes of Avanzo in Padua, which he restored. He died at Munich, April 29, 1885.

FÖRSTER, HEINRICH, a German prelate; born

at Grossglogau, Silesia, Nov. 24, 1800. He was educated at the University of Breslau, was ordained priest in 1825, and was, for a time, chaplain at Liegnitz and afterward pastor at Landshut. In 1837 he was attached to the cathedral at Breslau, and in 1853 was chosen to succeed Diepenbrock, prince-bishop of Breslau. He was strongly opposed to the doctrine of papal infallibility, but submitted when it was declared. It was largely due to Förster's efforts that the Prussian government was unsuccessful in its attempt to control ecclesiastical affairs, and for this reason he was suspended from his office in 1875. Among his published works are *Homilien auf die Sonntage des Katholischen Kirchenjahres* (1851); *Der Ruf der Kirche in die Gegenwart* (1852); *Die Christliche Familie* (1854); and *Kanzelvortrage*. He died Oct. 20, 1881.

FORSTER, JOHANN REINHOLD, a German traveler and naturalist; born at Dirschau, Prussia, Oct. 22, 1729. In 1753, having studied for the clerical profession, he became pastor at Nassenhuben, near Dantzig. His works include *Observations Made During a Voyage Round the World* (1778); *Flora America Septentrionalis* (1771); *Zoologie Rarioris Specilegium* (1781). He died at Halle, Dec. 9, 1798. See FORSTER, JOHANN GEORG ADAM, Vol. IX, p. 418.

FORSTER, WILLIAM, an English philanthropist; born at Tottenham, near London, March 23, 1784. He was of Quaker descent, became a minister of the Society of Friends in 1803, and married Anna, sister of Thomas Fowell Buxton, in 1816. In 1820 he visited the United States; in 1838 settled as a preacher near Norwich, England; in 1843-44 engaged in missionary work in France; and in 1846 visited Ireland, endeavoring to relieve the suffering there caused by famine. In 1849 he was commissioned by the Yearly Meeting of London to present an address on slavery and the slave trade to the rulers of Christian countries. In pursuit of this mission he visited most of the countries on the continent of Europe, and in 1853 went again to the United States, and had interviews with the President and with the governors of several Southern states. Before the completion of his work he died at Holston, Tennessee, Jan. 27, 1854.

FORSTER, WILLIAM EDWARD, a British statesman; born in Dorsetshire, England, July 11, 1819. He was educated at the Friends' school in Tottenham. Engaging in the manufacture of woolens, he made a fortune; and in 1861 entered Parliament for Bradford as an advanced Liberal. After holding several minor offices under Mr. Gladstone, he entered the Cabinet in 1870, and was instrumental in passing the Elementary Education Bill and the Ballot Law. In 1874 he visited the United States, and in 1875 was elected lord rector of Aberdeen University. Mr. Forster accepted, in 1880, the office of Chief Secretary for Ireland in Gladstone's Cabinet. In this capacity he introduced the Compensation for Disturbance Bill, a measure designed to relieve the tenant class. This passed the House of Commons, but was rejected

by the Lords. The land act of 1881 was accompanied by a coercion act, and when the Land League issued its "No Rent" manifesto, Forster retaliated by proclaiming the League as illegal. Under the coercion act he imprisoned Mr. Parnell and a great many members of the Irish Parliamentary party, as well as several priests and private citizens. He became known as "Buckshot" Forster, from an order which he gave to the Royal Irish Constabulary to load their guns with buckshot instead of ball. When the Gladstone Cabinet released the "suspects," Forster resigned, and thereafter opposed all of Mr. Gladstone's remedial measures as being merely concessions to treason. He died in London, April 5, 1886. See also HOME RULE, in these Supplements.

FORSYTH, a city and the capital of Monroe County, central Georgia, on the Central Railroad of Georgia, 60 miles S.E. of Atlanta. It has a large cotton trade and contains Monroe Female College. Population, 1900, 1,172.

FORSYTH, JAMES W., an American soldier; born in Ohio, Aug. 26, 1834; graduated at West Point in 1856, and served on the staffs of McClellan and Sheridan. He was brevetted colonel and brigadier-general in the regular army, became brigadier-general of volunteers, and in 1886 colonel of the 7th U. S. Cavalry, stationed on the frontier. He wrote a *Report of an Expedition up the Yellowstone River* (1875). He was in command at the battle of Wounded Knee, S. Dakota, Dec. 28, 1890; was made brigadier-general in 1894, and major-general in 1897.

FORSYTH, JOHN, an American statesman; born in Virginia, Oct. 22, 1780; died in Washington, District of Columbia, Oct. 21, 1841. He practiced law in Georgia; was elected attorney-general of that state in 1808, and sat in Congress from 1813 to 1818, when he became United States Senator. In 1819 he resigned to become minister to Spain, and negotiated the Florida cession with that country. From 1823 to 1827 he was again in Congress; from 1827 to 1829 was governor of Georgia; and in 1829 was again elected Senator. In 1834 he resigned and served as Secretary of State under Jackson and his successor, Van Buren, until March 3, 1841.—His son, JOHN FORSYTH, was born in Georgia about 1813. He became one of the foremost Democratic editors of the South. From 1856 to 1858 he was minister to Mexico, and in 1861, with Marshall J. Crawford, represented the Confederate States as commissioner to the national government. After the Civil War he was engaged in journalistic work in Mobile, Alabama, until, on account of ill health, he retired. He died at Mobile, Alabama, May 2, 1879.

FORSYTH, WILLIAM, an English barrister; born at Greenock, near Glasgow, in 1812; graduated from and elected a fellow of Trinity College, Cambridge, in 1834; called to the bar at the Inner Temple in 1839; became a queen's counsel in 1857, and was elected to Parliament for Marylebone in 1874, which he represented until 1880. He began publishing works on law in 1827, his first three referring to law in Scotland. His other works

include *Composition with Creditors* (1841); *Law Relating to Simony* (1844); *Hortensius*, a historical essay on the duties of an advocate (1849); *Custody of Infants* (1850); *History of Trial by Jury* (1852); *The Captivity of Napoleon at St. Helena*, from the letters, etc., of Lieutenant-General Sir Hudson Lowe (1853); *Life of Marcus Tullius Cicero* (1864); *Rome and Its Ruins* (1865); *Cases and Opinions on Constitutional Law and Various Points of English Jurisprudence* (1869); *The Novels and Novelists of the Eighteenth Century* (1871); *Letters from Lord Brougham to William Forsyth* (1872); *Hannibal in Italy*, a historical drama (1872); *Essays, Critical and Narrative* (1874); *The Slavonic Provinces South of the Danube* (1876).

FORSYTHIA, a genus of plants of the family *Oleaceæ*, consisting of two species (*F. viridissima* and *F. suspensa*) from eastern Asia, and common in cultivation. They are branching shrubs, with lanceolate or ovate leaves, and covered in early spring (before the appearance of the leaves) with abundant showy yellow flowers.

FORT. See FORTIFICATION, Vol. IX, pp. 421, 433, 434.

FORTALEZA. See CEARÁ, Vol. V, p. 282.

FORT ATKINSON, a city of Jefferson County, southeastern Wisconsin, 30 miles E. of Madison, on Rock River, near Lake Koshkonong, and on the Chicago and Northwestern railroad. It has manufactories of wagons, harrows, brooms, steam wheel-barrows, and of dairy and creamery apparatus, and contains foundries and flouring-mills. Population 1895, 2,815.

FORT BENTON, a city and the capital of Choteau County, central northern Montana, on the Great Northern railroad, 115 miles N.E. of Helena. It is at the head of navigation on the Missouri River. It has an important fur trade, and grazing, mining and agricultural interests. Population 1890, 624; 1900, 1,024.

FORT COLLINS, a town and the capital of Larimer County, central northern Colorado, on the Cache la Poudre River, and on the Union Pacific railroad, 60 miles N.W. of Denver. The region is thoroughly irrigated and is an exceedingly flourishing agricultural district. Flagstone is quarried in the vicinity. The town has good water-power, some manufactories and contains Colorado Agricultural College. Population 1890, 2,011; 1900, 3,054.

FORT COVINGTON, a village of Franklin County, northeastern New York, 15 miles N.W. of Malone, on the Salmon River (navigable), and on the Grand Trunk railroad. It has an academy. Dairying and farming are the principal industries. Population 1900, 822.

FORT DAVIS, a village and the capital of Jeff Davis County, western Texas, on Limbia Creek and 20 miles N.W. of Alpine, the nearest railroad station, on the Southern Pacific. It has two academies and is a stock-raising center. Population 1890, 1,563.

FORT DODGE, a city and the capital of Webster County, Iowa, 90 miles N. N.W. of Des Moines, on the Des Moines River, and on the Mason City

and Fort Dodge, the Illinois Central and the Minneapolis and St. Louis railroads. It has quarries where gypsum, fire-clay and water-lime are obtained, and coal is mined in the vicinity. It contains one of the largest oatmeal-mills in the state, a very good school system, a college and a Roman Catholic seminary. Population 1900, 12,162.

FORT EDWARD, a town of Washington County, central eastern New York, on the Delaware and Hudson River railroad, on the Hudson River and Champlain canal, and on the Hudson River, 28 miles N. of Troy. The river, which is here 900 feet wide, is dammed and affords abundant water-power. Lumber, castings, stoneware and machinery are manufactured. A collegiate institution is situated here. Fort Edward was a point of importance during the French and Indian wars, being at one end of the portage from Crown Point to the Hudson. During the Revolution it was held by the British and Americans in turn. Population 1900, 3,521.

FORTESCUE, HUGH, EARL OF, a British statesman, son of the second earl, who was Lord-Lieutenant of Ireland from 1839 to 1841; educated at Trinity College; entered Parliament, while he was Viscount Ebrington, for Plymouth, as a Liberal, for which constituency he sat until 1852, when he successfully contested Barnstaple. In 1854 he was elected for Marylebone, and in 1859 resigned on being called to the Upper House as Baron Fortescue; in 1861 he succeeded his father, as third Earl of Fortescue. He was Lord of the Treasury (1846-47); secretary of the Poor Law Board (1847-51); and the author of *The Health of Towns* (1844); *Official Salaries* (1852); *Representative Self-Government for the Metropolis* (1854); *Parliamentary Reform* (1859, 1884); and *Public Schools for the Middle Classes* (1864).

FORT GAINES, a town and the capital of Clay County, southwestern Georgia, on the Chattahoochee (navigable) River, and on the Central Railroad of Georgia, 60 miles S. of Columbus. It has a good commercial position, and a large trade in cotton and other products of the country, which it ships by the river. Population 1900, 1,305.

FORT HAMILTON, a village and fort on the east shore of the Narrows, New York harbor, in New Utrecht, Kings County, Long Island. This fort, with Fort Lafayette and the works on Staten Island, directly opposite, are intended for the defense of this entrance to the harbor. Population now comprised in Greater New York.

FORT HOWARD, a city of Brown County, central eastern Wisconsin, on the Fox River, near its mouth, opposite the city of Green Bay, of which it is now a part, and on the Chicago, Milwaukee and St. Paul, the Chicago and Northwestern and the Green Bay, Winona and St. Paul railroads. It has an excellent harbor, an extensive trade, is supplied with water-works, electricity and gas, manufactures great quantities of lumber, and machinery, bricks, boilers and numerous kinds of wooden articles, and has the carshops of the first and last railroads named above. Population now included in Green Bay city.

FORTIN, PIERRE, a Canadian fishery expert; born in Quebec in December, 1823; has held numerous government appointments, and was speaker of the Legislative Assembly in 1875. In the Canadian Parliament he represented Gaspé from 1867 to 1874; sat in the Legislative Assembly 1867 to 1881, and afterward in the Dominion Parliament, as a Conservative. He has devoted special attention to river and marine fisheries throughout the Dominion, and has written elaborate descriptions of marine animals. These treatises were published by the government. He founded the Marine Library of the province of Quebec, and was the first president of the Geographical Society of Quebec.

FORT KENT, a town of Aroostook County, northern Maine, in a heavily timbered region at the confluence of the St. John and Fish rivers. It has good water-power and manufactories of lumber. Population 1890, 1,826; 1900, 2,528.

FORT LEAVENWORTH, a village of Leavenworth County, northeastern Kansas, on the Missouri River. It is an important military post school of instruction for officers, and is a depot of supplies for Western forts. This fort was established in 1827.

FORT LEE, a village of Bergen County, northeastern New Jersey, on the Palisades of the Hudson, opposite One Hundred and Sixtieth Street, New York City. It was formerly a military station, and was captured by General Cornwallis on Nov. 18, 1776, together with its extensive military provisions and stores. Population 1895, 1,617.

FORT MADISON, a city and the capital of Lee County, southeastern Iowa, on the Mississippi River, and on the Atchison, Topeka and Santa Fé, the St. Louis, Keokuk and Northwestern and the Chicago, Fort Madison and Des Moines railroads. It has a state penitentiary, jail, schools and manufactories of sashes, blinds, doors, machinery, castings, beer, furniture, plows, lumber and leather. Population 1890, 7,901; 1900, 9,278.

FORT PAYNE, a city and the capital of De Kalb County, northeastern Alabama, in the Look-out Mountains, on the Alabama Great Southern railroad. Coal and iron are mined, and it has iron-works, rolling-mills, furnaces, fire-clay works and saw-mills. Pop. 1890, 2,698; 1900, 1,037.

FORT PLAIN, a village of Montgomery County, central eastern New York, 12 miles W. of Fonda, on the New York Central and Hudson River railroad, and on the Mohawk River and Erie canal. It has manufactories of brooms, springs and axles, a large furniture factory, knitting, woolen and silk mills, and contains the Clinton Liberal (Universalist) Institute. Population 1890, 2,864; 1900, 2,444.

FORT SCOTT, a city of southeastern Kansas, the capital of Bourbon County, and one of the most important places in the southeastern part of the state. The city is built on a high plateau, 800 feet above the level of the sea, on the south bank of the Marmaton River, near the Missouri

border, 90 miles S. of Kansas City, in the midst of a region rich in bituminous coal, the mining and shipping of which give the city its chief commercial importance. There are also extensive flagstone-quarries and cement-rock deposits in the vicinity. Ten lines of railway furnish an outlet for the mineral products. In 1890 there were ten miles of electric street-railways. The city has a fine park, in the center of which is an artesian well. The United States courthouse and post-office building cost \$150,000. There is a high school and a normal college, the latter having, in 1890, over 700 students, representing 12 states. The chief manufactures are flour, woolen goods, soap, sorghum and beet sugar, carriages, etc. Pop. 1890, 11,946; 1900, 10,322.

**FORT SELKIRK**, a trading post, Indian village, and Church of England mission, in Yukon territory, Canada, on the west bank of the Yukon, 5 miles below the junction of the Lewes and Pelly rivers. Old Fort Selkirk, across the river, two miles higher up, is in ruins, having been burnt by the Indians in 1852.

**FORT SHERIDAN**. See **SHERIDAN, FORT**, in these Supplements.

**FORT SMITH**, a city, one of the capitals of Sebastian Co., Ark., at the western boundary of the state, on the south bank of the Arkansas river, 170 miles from Little Rock, and on the St. Louis, Iron Mountain and Southern and St. Louis and San Francisco railroads. Congress donated to it a military reservation, worth \$750,000, for school purposes. The chief factories are saw-mills, planing-mills, iron foundries, machine-shops, oil-mills, etc. The machine-shops of the St. Louis and San Francisco Railway Company are located here, still further extending the employing capabilities of the place, which are now considerable. It has a large trade in the Indian Territory, and is the seat of the United States district court for the western district of Arkansas, having criminal jurisdiction in the Indian Territory. In 1889 the county erected a courthouse costing \$65,000. Other public buildings are the United States customhouse, courthouse, post-office and jail. Population 1880, 3,099; 1890, 11,311; 1900, 11,587.

**FORT SNELLING**, a village of Hennepin County, southeastern Minnesota, 6 miles S. of Minneapolis, on the Chicago, Milwaukee and St. Paul railroad. It was founded in 1820, and is an important United States military post. It is interesting as being the oldest settlement in Minnesota. Population 1895, 831.

**FORTUNATE ISLES**. See **CANARY ISLES**, Vol. IV, p. 795.

**FORTUNE**, **ROBERT**, a Scottish botanist; born in Berkshire, Sept. 16, 1813; died April 16, 1880. After serving an apprenticeship as a gardener he obtained employment in the Royal Botanic Gardens at Edinburgh, and afterward in the gardens at Chiswick. In 1842 he was sent by the Horticultural Society of London to collect plants in northern China. After his return he published *Three Years' Wanderings in Northern China* (1847). He subsequently visited China on three separate occasions, to study the methods of tea-cultivation, to carry plants from that coun-

try to India, and to collect seeds and plants for the government of the United States. *Yeddo and Peking* (1863) was written after his fifth and last journey to the East. His other books are *A Journey to the Tea Countries of China* (1852) and *A Residence Among the Chinese* (1857). Fortune was for a few years director of the Botanical Gardens at Chelsea.

**FORTUNE BAY**, an inlet on the Atlantic, on the southern coast of Newfoundland. See **NEWFOUNDLAND**, Vol. XVII, p. 382. Here, in January, 1878, several Gloucester fishing-vessels were attacked and driven away by residents of Fortune Bay District, in violation of treaty stipulations. Damages to the amount of seventy-five thousand dollars were awarded by Great Britain.

**FORTUNY, MARIANO**, a Spanish painter; born at Reus, Catalonia, June 11, 1838; died in Rome, Nov. 21, 1874. He studied in the Academy of Barcelona, and by the excellence of some early designs won a prize, which enabled him to go to Rome in 1858. When Spain declared war against Morocco, Fortuny accompanied the expedition to Africa and filled his portfolios with studies of Eastern life. On his return to Europe he renounced classical traditions, and giving full scope to his originality and genius, put on canvas the essence of the materials he had gathered. With name and fame already established, he went from Rome to Paris in 1866, and there his works were introduced to the whole art-loving world. In 1868 Fortuny went to Madrid, and there married Mdle. Madrazo, a daughter of the director of the Royal Museum. In 1870 he took up his residence in Granada, and in 1872 returned to Rome, where he resided until his death. His best-known pictures are *A Spanish Marriage*; *The Serpent-Charmer*; *The Amateur of Prints*; *A Fantasia at Morocco*; *The Sword-Sharpener*; *The Academicians of Arcadia*; *Book-Lover in the Library of Richelieu*; and some others. His *Dancing Arabs* is in Vanderbilt's house, New York. The occasion of his own wedding suggested his famous picture of *A Spanish Marriage*. Besides his work as a painter in oil, he gave considerable attention to etching and to water-colors. See **SCHOOLS OF PAINTING**, Vol. XXI, p. 440.

**FORT VALLEY**, a town of Houston County, central Georgia, 26 miles S.W. of Macon, on the Georgia Central and Southern railroads. It has a large trade in cotton and other agricultural produce. The surrounding region is considered to be one of the best peach and pear growing districts in the eastern United States. Population 1890, 1,752; 1900, 2,022.

**FORT WAYNE**, a city of northeastern Indiana, the capital of Allen County (see Vol. IX, p. 469). Fort Wayne is one of the chief cities in the state in population and in manufacturing importance, producing \$9,300,000 worth of manufactured articles annually, giving employment, on an average, to over 6,000 persons. An abundant supply of pure water is obtained from 30 wells, each eight inches in diameter and 55 feet deep, the outflow being 30,000,000 gallons daily. In 1891 there

were 13 public school buildings, a grammar school, with a library of 7,000 volumes, an extensive laboratory, and elaborate scientific apparatus. The Roman Catholics have a large and flourishing academy. The state asylum and school for feeble-minded youth is located at Fort Wayne, and has accommodations for 1,000 pupils. Eight railroad lines meeting here give the city unusual commercial advantages. Its leading manufactures are car-wheels, electrical apparatus, heavy machinery of all kinds, agricultural implements, leather, steam-engines, furniture, etc. Population 1880, 26,880; 1890, 35,393; 1900, 45,115.

**FORT WORTH**, a city of Texas, the capital of Tarrant County, situated at the confluence of the West, Clear and Trinity rivers, in the northern part of the state, about 175 miles N. of Austin. Next to Dallas, it is the most important railroad center in northern Texas, being on nine different railroads. It is surrounded by a rich agricultural region, producing cotton, grain and fruits. The city has a good water-supply, obtained from two sources, the Clear River and artesian wells, some two hundred in number. In 1890 there were in operation forty miles of electric street-railways. A fine bathing establishment, the Natatorium, costing \$50,000, is one of the institutions of the city. The courthouse and city hall are noteworthy structures, and the Chamber of Commerce building, which cost \$100,000. The high school building, completed in 1891, is a handsome and costly edifice. The Fort Worth University (Methodist) is located here, and the Roman Catholics maintain an academy. There are numerous manufactories, principally of flour, cotton and woolen goods, leather, etc., and rolling-mills, iron foundries, a jute factory, woven-wire factory, stock-yards and pork-packing establishments. These and a few other industries of less importance represent a capital of \$3,100,000, and a force of 2,700 employees. In 1872 there was but one house standing within the present city limits; in 1876, the population was 1,123; 1880, 7,000; 1890, 23,076; 1900, 26,688.

**FORTY MILE CREEK**, a stream of central eastern Alaska, formed on the slopes of the Alaska Mountains and the Tanana Hills. It takes a very tortuous, but generally northeasterly course, emptying into the Yukon River, in British America, about 15 miles E. of the Alaskan boundary. Considerable coarse gold is found in its bed and those of its tributaries. Length, about 120 miles.

**FORUM**, in law, any judicial tribunal for the adjustment of controversies, and in its modern significance almost synonymous with court. It is sometimes used technically, signifying the bar of a court. *Forum rei sitæ* is the forum or court having authority to decide a controversy concerning something located within its jurisdiction.

**FOSS, CYRUS DAVID**, an American Methodist Episcopal bishop; born at Kingston, New York, Jan. 17, 1834. He graduated from Wesleyan University, Middletown, Connecticut, in 1854; for

three years was an instructor in Amenia Seminary, New York; and in 1857 entered the traveling ministry in the New York Conference. In 1857-59 he was stationed at Chester, New York; in 1859-65 was in Brooklyn; and in 1865-75 in several churches in New York City. In 1875 he was chosen president of Wesleyan University, and served in that capacity until 1880, when he was elected and ordained a bishop. He was a member of the general conference in 1872, 1876 and 1880. Bishop Foss contributed to current literature and published several sermons and addresses.



BISHOP FOSS.

**FOSSIL**. See *Palæontology*, under **GEOLOGY**, Vol. X, pp. 319-325.

**FOSSIL FOOTPRINTS**, the name given to the impressions of the feet of extinct animals, made on the mud of former geological epochs, which has become hardened into stone. Reptilian and other tracks have been discovered upon the Triassic of Britain, and also in the same formation in Saxony; the impressions of worm-burrows in the Old Red Sandstones; fish-spines in the Carboniferous rocks of Scotland, etc. Imprints of the claws of crustaceans appear upon Silurian and other antique rocks. In America, crustacean impressions occur in the Cambrian of Canada and reptilian footprints in Pennsylvanian Carboniferous. Dr. Edward Hitchcock, president of Amherst College, made a minute description of those found in New England, specimens of which are preserved in the famous ichnological collection of that college, which contains over twenty thousand specimens, comprising all the typical specimens found in New England. The collection includes imprints of marsupials, reptiles and amphibia, batrachians, chelonians, fish, thick and narrow toed birds, besides insects and mollusks. The largest bird-tracks indicate an animal similar to the *dinornis* of New Zealand. The track of the largest batrachian is twenty inches long, and very much resembles that of the *Cheirotherium* found in Britain, except that the American example is minus a toe. Important conclusions may be drawn from these impressions as to the contemporaneity of species in palæontological epochs.

**FOSSIL FORESTS**, an erroneous name given to the petrified remains of trees which have been carried away from their place of growth, and become changed in character. For details as to one of these remarkable deposits, see **ARIZONA**, in these Supplements. Prof. O. C. Marsh has described a truly fossil forest, occurring in Napa County, California, where the trees have been silicified *in situ*. Similar fossil remains occur in the Yellowstone National Park.

**FOSTER, SIR BALTHAZAR WALTER**, an English physician and statesman; born near Cambridge, in

1840; obtained his medical education at the Royal College of Surgeons, Dublin, in which he became prosector of anatomy in 1859, and in 1864 obtained the degree of M.D. from Erlangen, Germany. In 1891 he was appointed emeritus professor of materia medica in Queen's College, Birmingham. He published *The Use of the Sphygmograph* (1866); *Method and Medicine* (1870); *Clinical Medicine* (1874); *How We Die in Large Towns* (1875); *Political Powerlessness of the Medical Profession* (1883); and was the author of the article on *Heart Disease* in *Quain's Dictionary of Medicine*. His medical career is but one side of Sir Walter's activities. He early took an interest in politics, was returned to Parliament for Chester in 1885, as an advanced home-ruler, and was a constant supporter of Mr. Gladstone. In Parliament he had charge of the Allotments and Small Holdings Bill, took a prominent part in securing the passage of the Medical Amendment Act, and was chairman of the National Liberal Federation. He was knighted on the dissolution of 1886. In 1892 he was appointed Parliamentary secretary of the Local Government Board in Mr. Gladstone's fourth Cabinet. He was the first medical man to reach the position of a Cabinet officer, and the event was suitably celebrated by a banquet in November, 1892, at the Hotel Metropole in London.

FOSTER, BIRKET, an English artist; born at North Shields, Feb. 4, 1825. He was educated at Hitchin, Herts. At an early age he showed remarkable talent for drawing, and as pupil to Landsells, wood-engraver, from 1841 to 1846, he produced a large number of subjects for wood-engraving, the earliest for Mr. and Mrs. S. C. Hall's *Ireland* (1843), and many for the *Illustrated London News*. He afterward illustrated Longfellow's *Evangeline*, Beattie's *Minstrel*, and Goldsmith's *Poetical Works*. In 1859 he exhibited the first of many water-colors, *The Mill at Arundel*; in 1860 he was elected an associate and in 1861 a member of the Water-Color Society. He devoted himself chiefly to depicting child-life and rural scenes; and he published *Pictures of Rustic Landscape* (1895). Died in London, March 28, 1899.

FOSTER, CHARLES, an American statesman; born at Tiffin, Ohio, April 12, 1828; became a merchant and banker in Fostoria, Ohio. In 1870 he was chosen to Congress as a Republican, and was three times re-elected. He was a member of the Ways and Means Committee, and was instrumental in bringing to light the Sanborn frauds, and in securing the repeal of the Moiety Law. As chairman of the



CHARLES FOSTER.

visiting committee to New Orleans to examine into the electoral frauds of 1874, he was the author of the report denouncing the acts of both parties. He was twice chosen governor of Ohio, and served

from 1880 to 1884. Under the Harrison administration he served as Secretary of the Treasury.

FOSTER, CLEMENT LE NEVE, an English mining expert; born at Camberwell, March 23, 1841. In 1853 he entered the Collège Communal at Boulogne; studied the sciences at Amiens; in 1857 entered the Royal School of Mines. Upon the suggestion of Professor Huxley, he went to the mining school at Freiburg, and was called from there to the Geological Survey of Great Britain by Sir Roderick Murchison in 1860. Meanwhile, he prepared himself for the science doctorate degree of the London University, and passed brilliantly in 1865. In the same year he accepted the lectureship to the Miners' Association of Cornwall and Devon. In 1867 he made an exploration of the mining capabilities of the Sinai peninsula, and in 1868 visited Venezuela. In 1872 he was appointed an inspector of mines in England, his district being in Cornwall. He was eventually successful in enforcing the regulations framed for the purpose of preventing the excessive loss of life in mines, greatly reducing the percentage of deaths and casualties. In 1890 he was appointed professor at the Royal School of Mines; in 1892 was appointed a commissioner at the Columbian Exposition at Chicago, acting as a judge in the mining department. He translated, from the Dutch of P. H. van Diesk, *Banca and Its Tin Stream-Works* (1867), and wrote *Ores and Ore-Mining*.

FOSTER, ELLEN HORTON, an American lawyer; born in Lowell, Massachusetts, Nov. 3, 1840. She removed to Clinton, Iowa, and was married (in 1859) to E. C. Foster. She was admitted to the bar in 1874, and argued a case in the supreme court the following year. She gained prominence as a lawyer, newspaper editor, lecturer and advocate of woman suffrage and prohibition.

FOSTER, GEORGE CARY, an English physicist; born at Sabden, Lancashire, Oct. 20, 1835; graduated at University College, London, in 1855; afterward studied at French and German universities; in 1862 was appointed professor of natural philosophy in Anderson's College, Glasgow; and in 1865 professor of physics in University College, London. In 1867 he opened the physical laboratory of the University of London, the first of the kind in London. He was the author of the articles on heat and thermodynamics in Henry Watts's *Dictionary of Chemistry and Allied Sciences*; and was the deviser of new methods of measurement in physical research.

FOSTER, GEORGE EULAS, a Canadian statesman; born in New Brunswick, Sept. 3, 1847; graduated at the University of New Brunswick in 1868; studied abroad, at Edinburgh and Heidelberg, and became professor of classics and history in the University of New Brunswick, 1872-79. He was elected to the Dominion Parliament in 1882; became Minister of Marine in 1885; and in 1894 was Minister of Finance in the Dominion Cabinet. While holding the former portfolio he was engaged diplomatically in the Bering Sea and Atlantic fisheries dispute. He was president of

the International Temperance Association and author of *The Prohibitionists' Handbook*.

FOSTER, MRS. ISABELLA H., more familiarly known as FAYE HUNTINGTON, an American authoress; born at Oneida Castle, New York, in 1838; graduated in 1860 at the Oneida Seminary, and became principal of the Home School for Girls at Verona, New York. Among her numerous works are *In Earnest* (1869); *Through Patience* (1869); *Allan Phillips* (1874); *Louisa's Mistake* (1875); *Ripley Parsonage* (1877); *Echoing and Re-echoing* (1878); *Millerton People* (1883); *Could n't Be Bought* (1885); *Stories of Great Men* (1887); *Stories of Remarkable Women* (1887); *A Modern Exodus* (1891); *A Baker's Dozen* (1892).

FOSTER, JOHN GRAY, an American soldier; born at Whitefield, New Hampshire, May 27, 1823; died in Nashua, New Hampshire, Sept. 2, 1874. He was graduated at West Point in 1846; served in the Mexican War, and received the brevets of first lieutenant and captain for gallantry. For a time he was employed on coast survey, and in 1855-57 was assistant professor of engineering at West Point. At the beginning of the Civil War he safely removed the garrison of Fort Moultrie to Fort Sumter, and was brevetted major for these services. In October, 1861, he was made brigadier-general of volunteers, and the same year was brevetted lieutenant-colonel. In 1865 he was brevetted major-general for gallant services in the field during the Rebellion. After the war he served as superintending engineer of various river and harbor improvements. He contributed to periodical literature on engineering topics, and wrote *Submarine Blasting in Boston Harbor*.

FOSTER, JOHN WATSON, an American statesman; born in Pike County, Indiana, March 2, 1836; graduated from the State University of Indiana in 1855; studied law at Harvard, and in 1857 began the practice of law in Evansville, Indiana. At the beginning of the Civil War he entered the Union service as a major, and distinguished himself at Fort Donelson, Shiloh, Knoxville and other battles. In 1869 he was appointed postmaster of Evans-



JOHN W. FOSTER.

ville, and in 1873 was sent to Mexico as United States minister. In 1880 he was transferred to Russia, but in 1881 resigned to attend to private business. In 1883-85 he was minister to Spain. In June, 1892, he was appointed Secretary of State, to succeed Blaine. In 1893 he represented the United States at Paris in the Bering Sea arbitration. In 1895 he acted as commissioner to secure peace between Japan and China; in 1897 as envoy to treat for the preservation of the fur-seal; and in 1898-99 as a member of the Canadian-American joint commission.

FOSTER, JOHN WELLS, an American geologist;

born at Brimfield, Massachusetts, March 4, 1815. In 1835 he was admitted to the Ohio bar, but his leisure moments were spent in the study of science. From 1835 to 1844 he was employed as an assistant in the geological survey of Ohio, and in 1845 visited the Lake Superior region in the interest of several copper-mining companies. In 1847 he was appointed on a geological survey of the Lake Superior region, and the results of his survey, published by Congress in 1852, still remain the authority. For a time after the completion of this work he lived in Massachusetts, where he was active in the formation of the Republican party. In 1858 he went to Chicago, and for a time was land commissioner for the Illinois Central railroad. Mr. Foster was president of the Chicago Academy of Sciences, and in 1869 was president of the American Association for the Advancement of Science. He published *The Mississippi Valley*, an elaborate work (1869); *Mineral Wealth and Railroad Development* (1872); *Prehistoric Races of the United States* (1873). He died in Chicago, June 29, 1873.

FOSTER, JOSEPH, an English genealogist and antiquarian; born at Sunderland, March 9, 1844. He was a nephew of Birket Foster, the artist, and inherited the genealogical talent of his grandfather. When in his eighteenth year he published *The Pedigree of the Fosters of Cold Hesledon in the County Palatine of Durham*. He then devoted his life to genealogical researches of the most laborious and herculean character, the nature of which is indicated by the following partial list of his publications: *Genealogical Account of the Families Descended from Francis Fox of St. Germans, Cornwall* (1872); *Pedigrees of the County Families of England* (commenced 1873); *Stemmata Britannica*, a genealogical account of the untitled nobility (1877); *The Peerage, Baronage and Knighthood of the British Empire* (1879); *Collectanea Genealogica* (1881-84); *Members of Parliament for Scotland, Including Minor Barons* (1882); *Our Noble and Gentle Families of Royal Descent* (1883); *Men at the Bar* (1885); and *Heralds' Visitations* of the counties of York, Durham, Northumberland, Cumberland, Westmoreland and Middlesex.

FOSTER, LAFAYETTE SABINE, an American statesman; born in Franklin, Connecticut, Nov. 22, 1806; died at Norwich, Connecticut, Sept. 19, 1880. He was graduated from Brown University in 1828; practiced law in Connecticut; and edited the *Norwich Journal* in 1835. In 1839-40, and again from 1846 to 1848, he sat in the legislature as a Whig, and for two years was speaker. He was mayor of Norwich in 1851; twice unsuccessful as a Whig candidate for the governorship, and in 1854 was again elected to the assembly, and chosen speaker. In May, 1854, he was elected to the United States Senate, and re-elected in 1860, serving until March, 1867. He joined the Republican party in 1856, and supported the Union cause during the war. In 1865 he was president *pro tem.* of the Senate, and became acting Vice-President of the United States when Andrew Johnson succeeded to the Presidency. In 1870

he again became a member and speaker of the Connecticut assembly, and in June was elected to the state supreme bench by the legislature. He supported Greeley for the Presidency in 1872, and was defeated as a Democratic candidate for Congress two years later. From 1870 to 1876 he was a judge of the state supreme court.

FOSTER, SIR MICHAEL, English physiologist; born at Huntingdon, March 8, 1836; educated at University College, London; became professor of physiology there, and then at Cambridge University, and was secretary of the Royal Society. He wrote *Report on Modern Microscopes and Recent Improvements in Microscopical Apparatus* (1867); *Primer of Physiology* (1874); *A Text-Book of Physiology*, which has gone through many editions since first published; and, with F. M. Balfour, *The Elements of Biology* (1874). He was knighted in 1899.

FOSTER, RANDOLPH SINKS, an American Methodist Episcopal bishop; born in Williamsburg, Ohio, Feb. 22, 1820. He received his education at Augusta College, Kentucky, and in 1837 entered the itinerant ministry of the Methodist Episcopal Church in the Kentucky Conference. Later he was transferred to Ohio, and in 1850 to New York. Up to 1857 he had held pastorates in Hillsboro, Portsmouth, Lancaster, Springfield, Cincinnati,



BISHOP FOSTER.

New York and Brooklyn. In 1856-58 he was president of the Northwestern University, Evanston, Illinois. For some time afterward he was pastor in New York and Sing Sing, and in 1868 was delegate to the British Wesleyan Conference. The same year he became professor of systematic theology in Drew Theological Seminary, Madison, New Jersey, and two years later was appointed president. In 1872 he became bishop of the Methodist Episcopal Church, and afterward made episcopal visitations in Norway, Sweden, Denmark, Germany, Switzerland, Italy, India, and South America. He published *Objections to Calvinism as It Is* (1849); *Christian Purity* (1851; revised ed., 1869); *Ministry for the Times* (1852); *Theism* (1872); *Beyond the Grave*; *Centenary Thoughts for the Pulpit and Pew of Methodism* (1884); and *Studies in Theology* (1886).

FOSTORIA, a city and railroad center of Seneca County, northwestern Ohio, on five railroad lines, 12 miles W. of Tiffin. It has natural-gas wells of great value, glass-works, flouring-mills, and other manufactories. The city has developed rapidly. Pop. 1890, 7,070; 1900, 7,730.

FOUCAULT CURRENTS, a name given to the eddy currents of electricity set up in a mass of metal when it is in a varying magnetic field. See *Induction in Masses of Metal*, under ELECTRICITY, Vol. VIII, p. 82.

FOULA. See ORKNEY, Vol. XVII, p. 846.

FOULARD, a light fabric of flexible silk, without twill, used principally for ladies' dresses. It was originally imported from India, but is now made also in the south of France.

FOULWEATHER, CAPE, a point of land on the Pacific Coast, 4 miles N. of Yaquina Bay, at lat. 44° 39' N., long. 124° 7' W.

FOUNDATIONS. See BUILDING, Vol. IV, pp. 452, 456; and BRIDGES, Vol. IV, p. 326.

FOUNDER OR LAMINITIS, a common trouble among horses, affecting the laminae of the feet, which are attacked with fever. Severe lameness ensues, and is accompanied by intense pain, and the exudation of blood or lymph between the sensitive laminae. The fore feet are more often affected than the hind feet. Sometimes the trouble extends to the muscles of the legs and chest, which become affected as in rheumatism. The causes of the trouble are overdriving or overloading, exposure to cold drafts or drinking cold water when the animal is heated or exhausted; disturbance of the digestive apparatus from improper feeding; diseases of the lungs; or improper shoeing. Prompt treatment is necessary. The shoes should be removed, a deep, comfortable bed provided, so as to encourage the horse to lie down, to relieve the pressure on the feet. Laxatives should be at once administered, and tincture of aconite, twenty drops to a dose, should be given at repeated intervals. The feet should be poulticed with bran. The hydropathic packing (sponge saturated with arnica) is also useful. Mash, roots, grass or hay should be fed to the animal; and water with a little cream of tartar should be at hand at all times. In summer the animal should be turned out to grass. Chronic cases are hardly curable, and in this, as in most other similar troubles, prevention is better than cure.

FOUNDRY PRACTICE. See IRON AND STEEL, in these Supplements.

FOUNTAIN-PEN. See PEN, Vol. XVIII, p. 484.

FOUQUIERA, a genus of Mexican trees or shrubs of the order *Tamariscineae*, resinous and brittle, having leafless branches and stems, and bearing brilliant crimson flowers.

FOURCROYA, a genus of plants of the order *Amaryllidaceae*, nearly allied to *Agave*, but with stamens shorter than the corolla. The species are all tropical. The leaves yield a fiber similar to the pita flax obtained from the species of the *Agave*.

FOURDRINIER, HENRY AND SEALY, British paper-makers, two brothers who brought to perfection the paper-making machine. They were born in London, Henry in 1766, and were stationers there, inheriting their father's business. Early in the century, about 1804, they had established a mill in Hertfordshire, which they made an experimental workshop in perfecting the machine. They spent \$300,000 in the work and became bankrupt. Others infringed their patents, and, though the government, in 1840, voted the brothers a compensation amounting to \$35,000,



Henry died in destitute circumstances. An annuity was purchased for his family by those engaged in the paper trade. The benefit derived from the introduction of their invention was estimated to amount to \$2,500,000 annually. Henry died in 1854 and Sealy in 1847. See PAPER, Vol. XVIII, p. 219.

FOUR EVANGELISTS, part of a larger group of islands known as the Twelve Apostles, which lie off the west entrance of the Strait of Magellan, southern Chile. The eight other islands, with which they are classed as above, are about fifteen miles farther out into the Pacific.

FOUR LAKES, a chain of deep lakes, Mendota, Monona, Waubesa and Kegonsa, in Dane County, southern Wisconsin, connected by short outlets. The state capital, Madison, is situated between the first two. Lake Mendota is the largest, being 6 miles long by 4 wide. Lake Monona is 6½ miles long by 2 wide. The other two are about half the size of the first two. Their outlet is through the Yahara River into the Rock River.

FOURNI ISLANDS, a group of about twenty small islands in the Grecian Archipelago, between Nicaria and Samos, off the western coast of Asiatic Turkey. The largest of these is about five miles in circuit.

FOURTH, in music, an interval including four degrees of the scale. The interval of the perfect fourth contains two whole tones and one semitone; a diminished fourth, one whole tone and two semitones; and the superfluous or augmented fourth, three whole tones. The perfect fourth is the second most perfect consonance after the octave, and the next to the fifth.

FOWLER, a city and the capital of Benton County, northwestern Indiana, 27 miles N.W. of Lafayette, on the Cleveland, Cincinnati, Chicago and St. Louis railroad. Surrounding the place are fertile farms. The products of the city are agricultural implements and furniture. Population, 1,285; 1900, 1,429.

FOWLER, CHARLES HENRY, an American Methodist Episcopal bishop; born at Burford, Canada, Aug. 11, 1837. He graduated at Genesee College, Lima, New York, in 1859, and in 1861 at Garrett Biblical Institute, Evanston, Illinois. The same year he was admitted into the Rock River conference, and was appointed to churches in Chicago till 1872, when he was chosen president of Northwestern University. In 1876 he was elected editor of the New York *Christian Advocate*, and, in 1880 became one of the corresponding secretaries of the Missionary Society of the Methodist Episcopal Church. In 1884 he was elected and ordained bishop.

FOWLER, SIR JOHN, an English civil engineer; born at Sheffield in 1817; assisted in the construction of the London and Brighton and other railway lines, and was afterward engineer of the Manchester, Sheffield and Lincolnshire group of railways, besides many other lines, including the original "Underground" or Metropolitan railway, London. River-improvement and the construction of large docks also occupied his attention,

and he was knighted in 1885 for his services as consulting-engineer in the public works in Egypt; but his greatest work is the Forth Bridge, completed in 1890, designed by him and Sir Benjamin Baker. For this work he was created a baronet. He was president of the Institution of Civil Engineers in 1866. Died at Bournemouth, Nov. 20, 1898.

FOWLER, ORSON SQUIRE, an American phrenologist; born at Cohocton, New York, Oct. 11, 1809; died Aug. 18, 1887. He was graduated at Amherst College in 1834; became a lecturer on phrenology, health, hygiene, self-culture and social reform; published many works on these subjects, which were issued from New York, where he established a publishing-house in conjunction with his brother, Lorenzo F. Fowler. The brothers located eventually in Manchester, Massachusetts. Their publications include *Memory and Intellectual Improvement* (1841); *Physiology, Animal and Mental* (1842); *Matrimony; or, Phrenology Applied to the Selection of Companions* (1842); etc.—His brother, LORENZO NILES FOWLER, also a phrenologist; born at Cohocton, New York, June 23, 1811. He was educated at Amherst College, and entered, with his brother, upon phrenological investigations. He edited the *Phrenological Journal*, and published, with his brother, the works mentioned. He spent the last 35 years of his life in London. He died in West Orange, New Jersey, Sept. 3, 1896.

FOWLER, SAMUEL, an American mineralogist and geologist; born near Newburgh, New York, Oct. 30, 1799; studied medicine and removed to Franklin, New Jersey, where he practiced. He was active in local politics; was sent to the state senate, and twice to Congress, during the administration of President Jackson. As a mineralogist he attained much fame, his contributions appearing in many scientific publications. The mineral, *fowlerite*, named in his honor, was discovered by him; and he is credited with naming the iron and zinc ore *franklinite*, which he first brought to general notice. He died at Franklin, New Jersey, Feb. 20, 1844.

FOWLER, THOMAS, an English philosophical writer; born at Burton Stather, Lincolnshire, Sept. 1, 1832; graduated at Merton College, Oxford, in 1854; elected to a fellowship in Lincoln College in 1855, and became professor of logic in the university in 1873, holding the position until 1879. He was elected president of Corpus Christi College in 1881; and next year received the honorary degree of LL.D. from Edinburgh. He was the author of *Elements of Deductive Logic* (9th ed. 1887); *Elements of Inductive Logic* (6th ed. 1892); *Progressive Morality* (1884); *The Principles of Morals* (1886, 1887); and of biographies of Locke, Bacon, Shaftesbury and Hutcheson; and *History of Corpus Christi College* (1893). He contributed the articles HUTCHESON and SHAFTESBURY to this ENCYCLOPÆDIA.

FOWLERITE. See MINERALOGY, Vol. XVI, p. 417.

FOWLER'S SOLUTION. See ARSENIC, Vol. II, p. 634.

FOX, SIR CHARLES, an English engineer; born at Derby, March 11, 1810; was first employed by Ericson, and appointed by Robert Stephenson assistant engineer of the London and Birmingham Railway Company. He was largely employed in the construction of railways (many of them of the narrow-gauge design), bridges and tunnels. He constructed, from Sir Joseph Paxton's plans, the Crystal Palace for the exhibition of 1851 in London, and also the Crystal Palace at Sydenham. He died at Blackheath, June 14, 1874.

FOX, GUSTAVUS VASA, an American naval officer; born at Saugus, Massachusetts, June 13, 1821; died in New York City, Oct. 29, 1883. He entered the navy in 1838 as midshipman, and served until 1856, when he resigned, with the rank of lieutenant. He then accepted the position of agent of the Bay State Woolen Mills, at Lawrence, Massachusetts. At the beginning of the Civil War he was appointed assistant secretary of the navy, and his services in this position were very valuable, especially in planning the capture of New Orleans and the opening of the Mississippi. Soon after the war he was sent on a special mission to Russia, to convey to the czar the congratulations of the United States Congress on his escape from assassination. Captain Fox subsequently became manager of the Middlesex Mills.

FOX, MARGARETTA AND KATHARINE, two American spiritualistic mediums; born, respectively, in 1836 and 1839, in Bath, Canada. Margaretta, in 1888, confessed to having practiced deception, but afterward retracted the confession. She claimed to have married Dr. Kane, the Arctic explorer, whose correspondence with her she published after his death (*The Love Life of Dr. Kane* [1865]). She died in Brooklyn, N. Y., March 8, 1893. Katharine continued the séances until 1888; was married to Henry D. Jencken in 1873; and died in New York city, July 2, 1892. For descriptions of their methods, see SPIRITUALISM, Vol. XXII, pp. 405, 407.

FOX, WILLIAM JOHNSON, an English orator and politician; born at Uggheshall, his father's small farm, near Wrentham, Suffolk, in 1786. His father removed to Norwich to engage as a weaver, and the boy was sent to Homerton College, London, to be trained as an Independent minister, but was soon attracted to Unitarianism, and became a leader of the English rationalists. He was one of the most powerful orators in favor of the repeal of the Corn Laws, his speeches being quoted by M. Guizot as the most finished productions on the subject. His *Letters of a Norwich Weaver-Boy* contributed much to the promotion of free trade. He was elected to Parliament in 1847, and sat until 1863. He died in London, June 3, 1864. He published three volumes of sermons and a work entitled *The Religious Ideas*, and edited *The Monthly Repository*.

FOXBORO, a village and township of southern Norfolk County, eastern Massachusetts, 21 miles S.W. of Boston, on the New York, New Haven and Hartford railroad. It has large manufacturing industries. Straw hats, bonnets, carpet-linings, soap and spring-beds are made in the town-

ship. There is a granite-quarry here. Population of township in 1890, 2,933; of town in 1900, 3,266.

FOXGLOVE. See DIGITALIS, Vol. VII, p. 237.

FOXHOUND. See HOUND, Vol. XII, p. 314.

FOX-HUNTING. See HUNTING, Vol. XII, p. 394.

FOX INDIANS. See *Sacs*, under INDIANS, Vol. XII, p. 832.

FOX ISLANDS. See ALEUTIAN ISLANDS, Vol. I, pp. 479, 480.

FOX RIVER, the name of two streams rising in Wisconsin. (1) The Fox River, or Pishtaka, rises in Waukesha County, southwestern Wisconsin, flows south to Aurora, Illinois, then southwest to the Illinois, which it enters at Ottawa. (2) The Fox River, or Neenah, rises near the southern boundary of Green Lake County, first flows west to Portage City, then, after a tortuous but generally northeast course of about 250 miles, empties into Green Bay, in Lake Michigan. Near its headwaters it approaches within one and a quarter miles of the Wisconsin River, with which it is connected, at Portage City, by a canal, which thus unites the Mississippi and Lake Michigan.

FOX-SHARK OR THRESHER. See SHARK, Vol. XXI, p. 777.

FOXTAIL-GRASS, a common name given to various grasses with brush-like spikes, notably species of *Alopecurus*, *Setaria*, and *Andropogon*. The common "foxtails" are a species of *Setaria* from the Old World, but several of them cultivated and naturalized in the United States; as, *S. glauca* "common foxtail"; *S. viridis*, "green foxtail," or "bottle-grass"; and *S. Italica*, "Italian millet," or "Bengal grass."

FOYERS, a small river of Inverness-shire, Scotland; rises in Monadhliadh Mountains, flows north into Loch Ness eight miles N. E. of Fort Augustus; noted for its cascades; the lower fall, 90 feet high, is the finest cascade in Britain.

FOYLE, RIVER. See DONEGAL, Vol. VII, p. 361.

FRACTIONS. See ALGEBRA, Vol. I, pp. 529-33; ARITHMETIC, Vol. II, p. 529.

FRACTURES. See SURGERY, Vol. XXII, p. 681, and in these Supplements; also PATHOLOGY, Vol. XVIII, pp. 366-67.

FRAGA, a town of Huesca province, Spain, on the Cinca river, 18 miles S.W. of Lerida, in a fertile and well-tilled plain; is the site of an old fortress, where, in 1134, the Moors defeated ALFONSO I of Aragon (q. v., Vol. I, p. 617). Pop. 7,158.

FRAGONARD, JEAN HONORÉ, a French genre and decorative painter; born at Grasse, April 5, 1732; was a pupil of Chardin and Boucher; gained the *grand prix de Rome* in 1752; went to Rome on a pension. On his return to Paris he became much in request as a portrait-painter. His pictures are to be seen in many of the museums in France and elsewhere. In Nov., 1898, fourteen of his finest works, including a series of five panels representing the *Romance of Love and Beauty*, after lying hidden for over a century in an old farm cottage at Grasse, were unearthed, and exhibited and sold in London. He died in Paris, Aug. 22, 1806.—His son, ALEX-

ANDER EVARISTE FRAGONARD, also a historical painter, was born at Grasse in 1780. He was a pupil of David; was also a sculptor, and received the decoration of the Legion of Honor in 1819. He died in Paris, Nov. 10, 1850.

FRAMINGHAM, a township in Middlesex County, Massachusetts, comprises the villages of Framingham Center, South Framingham and Saxtonville. It has the oldest normal school in America. Among the articles manufactured here are carriages, woolen and straw goods and shoes. Population of town in 1900, 11,302.

FRA MONREALE. See ROME, Vol. XX, p. 801; and CONDOTTIERI, Vol. VI, p. 256.

FRANC, a French silver coin which forms the unit of the French monetary system, its value being about 9½d. English money, or 19 cents of United States. The franc is divided into 100 centimes; but the old division into 20 sous, valued at 5 centimes each, is still made use of in common life. There are, in France, silver coins of ½, ¼, 1, 2 and 5 francs, and gold pieces of 5, 10, 20, 50 and 100 francs. See MONEY, Vol. XVI, pp. 730, 731, note; 732, note.

FRANÇAIS, FRANÇOIS LOUIS, a French artist; born at Plombières, in the Vosges, Nov. 17, 1814. He was sent to Paris, and engaged to a publisher, who was the means of obtaining employment for him at the glass-works at Choisy-le-Roy, where he learned painting on glass. He returned to Paris, and shortly afterward entered the studio of Gigoux, where he learned to draw on wood and also the art of lithography. In 1837, after many misgivings, he sent to the Salon, in association with M. H. Baron, a picture, *A Song Under the Willows*, a landscape with figures, in Lombard costume of the sixteenth century. He exhibited at the Salon with increasing success for some years, and then went to Italy, where he spent three years. In 1853 he exhibited *The End of the Winter*, which was bought for the Luxembourg; in 1855 his *Path Through the Corn* was purchased by the state, for which, at the same time, he received a medal of the first class from the Salon. In 1857 he produced what he regarded as his finest work, *A Fine Winter's Day*; in 1861 *View at Bas Meudon*; and in 1863 *Orpheus*. He exhibited regularly at the salon, his later works including *Morning at Chinon* and *Last Days of Autumn in the Vosges* (1884); *Views in the Vicinity of Clisson* (1889); *A Misty Morning in the Vicinity of Paris* (1890); *Source of Evening* (1891). He was promoted an officer of the Legion of Honor in 1867; and elected to the Academy of Fine Arts in 1890. Died May 28, 1897.

FRANCE. For the geography, history, government and productions of France from its earliest settlement to the close of the year 1879, see Vol. IX, pp. 505-686. After the resignation of Marshal MacMahon, and the election of M. Grévy to the Presidency, the Republican party, under the leadership of the eloquent Gambetta, instituted various measures of doubtful expediency. The Communards were rehabilitated; the church was irritated by violent measures; the Tunis expedition was entered upon; and the peasant

proprietors, the true conservative power in France, became distrustful of their chosen representatives. Gambetta's accession to the Premiership was not calculated to allay the general distrust, and his death (1882) left his party without a leader, and the people without an idol. Owing to the vacillating policy of the Ministry, French influence in Egypt was greatly weakened, and the Tonquin expedition and embroilments with China increased the general feeling of distrust. Accusations of jobbery and malversations brought against the son-in-law of M. Grévy led to the resignation of the latter, Dec. 2, 1887. In his message to the Senate and Chamber of Deputies he declared that they had practically summoned him to resign, and he yielded in order to avoid the possible consequences of a conflict between Parliament and the executive. M. Marie François Sadi-Carnot was elected President of the republic, and a new ministry formed, with M. Tirard as president of the Council.

The political situation became still further disturbed about this time by the efforts of General Boulanger, who was supported in his schemes of personal political aggrandizement by the three reactionary parties—the Orleanists, the Imperialists and the Legitimists. General Boulanger had proved a very efficient Minister of War, and by his patriotic utterances and the reforms he introduced in the treatment of the privates and non-commissioned officers, became a sort of popular idol among all classes. He was a convenient figure-head for a movement of discontent with the situation and a desire for a revision of the constitution; and the rational, practical and undoubtedly liberal parliamentary institutions which the third republic had implanted in France seemed to be in serious jeopardy.

In the French Senatorial elections of Jan. 5, 1888, the Republicans lost three seats, and early in April a new ministry was formed, with M. Floquet as president of the Council. General Boulanger was elected to the Chamber of Deputies from the Department du Nord, April 15th, by over 96,000 majority, and at once became the leader of the opposition to the government. After a stormy debate, a motion by General Boulanger for the dissolution of the Chamber was rejected by that body, July 12th, and a vote of censure passed upon him, whereupon he resigned; but at the election in Paris, which took place Jan. 27, 1889, he was re-elected by a majority of 54,432. On February 14th, Premier Floquet tendered the resignation of the Cabinet, and a new Cabinet, with M. Tirard as Premier, was announced February 21st. By a resolution adopted April 4th, the French Chamber decided to prosecute General Boulanger for threatening the peace of the republic. The trial began before the High Court of the Senate August 8th, and resulted in the conviction of the General, together with Count Dillon and Henri Rochefort, of conspiracy and attempt at treason. They were condemned to transportation and imprisonment in a fortified place; but General Boulanger escaped

to England. His connection with a plot for the restoration of the Orleanists was proved, and in 1891 he committed suicide.

Within the four years following the downfall of Boulangism, France underwent numerous changes of ministries, and her institutions suffered from many strains. The failure of the Panama canal scheme led to the prosecution of the Comte de Lesseps (q. v.) and his son; of Gustave Eiffel (q. v.) and of many politicians and ex-ministers; a few of them (the two Lesseps and Eiffel included) were convicted of bribery and corruption in January, 1893, and sentenced to imprisonment and fine. The Comte de Lesseps was spared the imprisonment on account of poor health and age, and died December, 1894. While driving through the streets of Lyons, on Sunday, June 24, 1894, President Carnot was assassinated by an Italian anarchist, Cesario Santo. His successor in the Presidency was M. Casimir-Perier, who resigned after being little more than six months in office. M. Felix Faure (q. v.) was then elected President by the National Congress, in its regular session at Versailles, early in 1895. The passage of the amnesty bill enabled those who had been sentenced on account of the Boulanger plot to return, among the first to take advantage of the amnesty being M. Henri Rochefort. A Chinese loan of \$75,000,000 was raised in France on the guaranty of the Russian government. June 17th the Russian ambassador invested the President with the insignia of the Order of St. Andrew. An act was passed, July 14th, to reorganize the council of the Legion of Honor, so as to free the order from any suspicion of undue influence. The Ribot ministry, formed Jan. 26, 1895, resigned October 28th of the same year and was succeeded by a Cabinet, of which M. Bourgeois was the Premier. The Bourgeois Cabinet remained in power until April 23, 1896, when it was in turn succeeded by a Ministry led by M. Meline. The latter held office till June, 1898, when his administration was overturned, and was replaced by a Radical ministry under M. Brisson. The general election, held in the previous month (May, 1898), showed a notable increase in the numbers of the Radicals and Socialists elected, and the Moderate Republicans were no longer able to hold their own against the combined forces of the opposition. The strength of parties in the Chamber at this juncture was as follows: Moderates, 254; Rallied, 40; Radicals, 178; Socialist Radicals, 57; Reactionaries, 44; and Anti-Scimites, 10. In Oct. (1898) M. Brisson's ministry, therefore, fell, and was succeeded by one of "Republican Concentration," under M. Dupuy. To M. Dupuy, in turn, there succeeded in June, 1899, a Cabinet under M. Waldeck-Rousseau, including representatives from almost all parties. At the present time of writing (Oct. 1900) it is still in power.

The Presidency of the French Republic had in the interval changed hands, owing to the death (Feb. 1899), of M. Faure, who in 1895 had succeeded M. Casimir-Perier. M. Faure's successor was M. Émile Loubet, a Moderate party man, with

Radical tendencies, who had at one time been Prime Minister and President of the Senate. Under M. Loubet's rule, France has enjoyed a period of comparative internal quiet, if we except the agitations and excitements incident to the famous Dreyfus case (q. v., in these Supplements under DREYFUS). Externally the Republic has had little, meanwhile, to disturb its repose, save for the diplomatic contentions with Great Britain, owing to France's Anglophobic thwarting policy in the Upper Sudan, afterwards happily annulled by the delimitation of territory, by mutual agreement (Mar. 1899), following the Marchand incident at Fashoda. Antananarivo, capital of Madagascar, surrendered to the French, Sept. 30, 1895. A treaty was signed, which provided for a French protectorate over the island. This was changed in June, 1896, and Madagascar was formally annexed to France.

In the summer of 1900 the capital of the Republic was greatly occupied by its engrossing interest in the Paris Exposition, which see, under PARIS EXPOSITION, in these Supplements.

The area of France is 204,092 square miles, and the population in April, 1896 (exclusive of her dependencies), 38,517,975; density per square mile, 188.7. The population of France increases very slowly, owing to the low rate of births. The average number of births per marriage was (1881-85) about 3; in 1891 it was 2.1. Of the total population in 1891, 50.35 per cent. were females. The birth-rate for all France, in 1898, was 22.1 per 1,000 inhabitants; the death-rate in the same year was 21.2. The number of divorces is rapidly increasing. The population of the chief cities of France, according to the Census of 1896, was as follows: Paris (the capital) 2,536,834; Lyons 466,028; Marseilles 442,239; Bordeaux 256,906; Lille 216,276; Toulouse 149,963; St. Etienne 136,030; Roubaix 124,661; Nantes 123,900; Le Havre 119,470; Rouen 113,219; Reims 107,063.

*Colonies and Dependencies.* The foreign possessions of France, (including Algeria and Tunis, Madagascar [acquired in 1896], Dahomey, Congo, French Guinea, Senegal, Sudan, and the Sahara Region in Africa, French India and Indo-China, Cochin-China, and the lately acquired territory of Tonking, Kwang Chi Wan, and the Laos Protectorate), may be roughly estimated to have an area of 3,740,000 square miles, with a population of about 56 millions. Their administration is directed or controlled by the Ministry of the Colonies, which in 1894 was organized as a separate department. Most of them enjoy some measure of self-government and have, in some instances, elective councils to assist the governor. Few of the colonies have a revenue sufficient to defray the cost of administration. They moreover entail heavy burdens on the ministries of war and marine.

*Religion and Public Instruction.* All religions in France are on a legal equality, every sect being entitled to a grant from the State if its numbers exceed 100,000. But the Roman Catholics form the large majority of the population. Primary education is free and obligatory; it is also admirably

organized. Secondary education is supplied in over 400 schools specially organized for that purpose, with about 100,000 pupils; and there are also many technical schools, such as the Conservatoire des Arts et Metiers at Paris (with 18 evening courses on the applied sciences and social economy), the École des Hautes Études Commerciales, etc.; besides 15 universities. The number of students attending the universities in the faculties of law, medicine, science, letters, pharmacy, etc., was in 1899 26,499. The government appropriation for the year 1900 for instruction and fine arts amounted to \$44,085,545.

*Finance.* The budget estimates of the revenue of the Republic, including those of Algeria, for 1900 were \$704,626,650, and the estimated expenditures, 704,523,200. The national debt of France, consolidated and floating, amounted, on Jan. 1, 1899, to \$5,989,660,200.

*Money, Weights, and Measures.* The *Franc* of 100 *centimes* is of the value of 19c U. S. cy.,  $9\frac{1}{2}d$ . or 25.225 francs to the pound sterling.

Gold coins in common use are 20 and 10 franc pieces. The 20 franc gold piece weighs 6.4516 grammes .900 fine, and thus contains 5.80645 grammes of fine gold. Silver coins are 5, 2, 1, and half franc pieces and 20-centime pieces. The 5-franc silver piece weighs 25 grammes .900 fine, and thus contains 22.5 grammes of fine silver. The franc piece weighs 5 grammes .835 fine, and contains 4.175 grammes of fine silver. Bronze coins are 10 and 5 centime pieces.

There is a double standard of value, gold and silver, the ratio being theoretically  $15\frac{1}{2}$  to 1. Of silver coins, however, only 5-franc pieces are legal tender, and of these the free coinage has been suspended since 1876.

The present monetary convention between France, Belgium, Italy, Switzerland, and Greece is tacitly continued from year to year, but may be denounced by any of the contracting States, and, if denounced, will expire at the end of the year, which commences on January 1, following the denunciation. According to its terms, the five contracting States have their gold and silver coins respectively of the same fineness, weight, diameter, and current value, and the allowance for wear and tear in each case is the same.

The monetary system of the Union has been adopted, either wholly or partially, in Spain, Rumania, Bulgaria, Servia, Russia, Finland, and many of the South American States.

<i>Gramme</i>	= 15.43 gr. tr.	<i>Mètre</i>	= 39.37 inches.
<i>Kilogramme</i>	= 2.205 lbs. av.	<i>Kilomètre</i>	= 1.621 mile.
<i>Quintal Métrique</i>	= 220 $\frac{1}{2}$ "	<i>Mètre Cube</i>	} = 35.31 cubic ft
<i>Tonneau</i>	= 2,205 lbs.	<i>SÈCLE</i>	
<i>Libre, Liquid</i>	= 1.76 pint.	<i>Hectare</i>	= 2.47 acres.
<i>Hectolitre</i> } Liquid	= 22 gallons.	<i>Kilomètre Carré</i>	= 386 sq. m.
	} Dry		
	= 2.75 bushels.		

*Defence.* The military forces are organized on the basis of laws voted by the National Assembly in 1872, supplemented by further organization laws passed in 1873, 1875, 1882, 1887, 1889, 1890, and 1892. These laws enact universal liability to military service. Substitution and enlistment for money are forbidden, and it is ordered that every Frenchman not declared unfit for military service

may be summoned, from the age of 20 to that of 45 years, to enter the active army or the reserves. By the law of 1882, supplemented by that of 1888, the yearly contingent must serve three years in the active army, six in the reserve, six in the territorial army, and ten in the territorial reserve. The active army is composed of all the young men not otherwise exempted, who have reached the age of twenty; and the reserves of those who have passed through the active army. Neither the active army nor its reserve is in any way localized, but drawn from and distributed over the whole of France. On the other hand, the territorial army and its reserve are confined to fixed regions, determined from time to time by administrative enactments. According to the budget for 1900, the peace strength of the whole French army is composed of 540,405 men, of whom 26,847 are officers. These include the men in the gendarmerie and in the Garde Républicaine. Besides these there is a force in Algeria of 60,102 men (2,309 officers), and in Tunis of 15,968 men (584 officers) — a grand total of 616,475 men (of whom 29,740 are officers).

In addition to this grand total, the territorial army numbers about nine hundred thousand men and officers. Taking into account the various classes of reserves, France has a war force of about two and one-half millions of men at her disposal; and, taking account of the various classes of able-bodied men whose services have been dispensed with, the total number amounts to 4,350,000 trained soldiers.

The French effective navy, in 1898, comprised 19 1st-class, 10 2nd-class, and 7 3rd-class battleships, 14 coast-defence vessels; 13 1st-class, 17 2nd-class, and 10 3rd-class cruisers; 21 torpedo gunboats; and 125 1st-class, 78 2nd-class, and 43 3rd-class torpedo boats; besides a number of submarine boats, completed or building. A large sum (about 22 $\frac{1}{2}$  million dollars), was in 1899, according to the new navy programme, appropriated for new constructions, and for new armaments and boilers for the older battleships. Among the torpedo craft recently launched is the *Narval*, which is a submersible boat, propelled on the surface by an oil motor, and below water by electricity, while the engine can be used during ordinary flotation for the charging of the electric accumulators.

*Products.* Of the total area of France (52,921,578 hectares), 8,397,131 hectares are under forests and 36,977,098 hectares under all kinds of crops, fallow and grasses. The production of wine in 1898 amounted to 31,730,000 hectoliters, and the value of the crop of chestnuts, walnuts, olives, and plums was about \$40,220,000. On Jan. 1, 1895, the number of farm-animals in France were: horses, 2,807,042; cattle, 12,879,240; sheep, 20,721,850; pigs, 6,038,372; goats, 1,484,921. Silk culture is carried on in 27 departments, giving employment to 123,288 persons. In 1898 the raw silk exported amounted in value to \$18,066,510; the value of the silk manufactures exported from France into England alone was in 1898 over 62 million dollars.

The mineral and metal products for 1897 were, in tons: Coal and lignite, 30,797,900; pig-iron, 2,484,200; iron ore, 4,582,000; finished iron, 784,000; steel, 1,325,213.

On Jan. 1, 1899, the French mercantile navy consisted of 14,406 sailing-vessels, of 414,673 tons, and with crews, 67,583; 1,209 steamers, of 485,617 tons, and crews numbering 20,627. In 1898, of the sailing-vessels, 150, of 14,824 tons, were engaged in the European seas, and 271, of 178,307 tons, in ocean navigation; of the steamers, 244, of 186,407 tons, were engaged in European seas, and 174, of 269,606 tons, in ocean navigation. The rest were employed in the coasting trade, in port service, or in the fisheries. Of the sailing-vessels and steamers, 13,720 were not over fifty tons.

The total amount of coin put into circulation by France from 1795 till Jan. 1, 1900, was 9,565,473,070 francs gold, and 5,060,606,240 francs silver. The French money coined in 1898 amounted to 218,326,540 francs, of which 1,000,000 francs were bronze.

In 1898 the total imports amounted to \$894,500,000, and the exports to \$702,180,000. The principal articles of import were wine, raw wool, cereals, raw silk, raw cotton, timber and wood, hides and furs, oil-seeds, coffee, coal and coke, fruits, cattle, sugar, woolen, silk, and cotton textiles and flax. The principal articles of export were woolen, cotton and silk textiles, wine, raw silk and yarn, raw wool and yarn, small ware, leather goods, linen and cloth, metal goods (tools), cheese and butter, spirits, sugar, skins and furs, and chemical products.

In 1899 there were 23,576 miles of railroad, including 1,700 miles belonging to the State, and 62,952 miles of telegraph lines in France, and 237 miles of pneumatic tubes in Paris. On Dec. 31, 1899, the length of tramways worked was 2,319 miles.

The following is a list of the Sovereigns and Governments of France, from the accession of the House of Bourbon:

HOUSE OF BOURBON	SECOND REPUBLIC
Henri IV . . . . . 1589-1610	Provisional Government, Feb.—Dec. . . . . 1848
Louis XIII., "le Juste" . . . . . 1610-1643	Louis Napoleon . . . . . 1848-1852
Louis XIV., "le Grand" . . . . . 1643-1715	
Louis XV . . . . . 1715-1774	
Louis XVI. (+ 1793) . . . . . 1774-1792	
FIRST REPUBLIC	EMPIRE RESTORED
Convention . . . . . 1792-1795	Napoleon III (died 1873) 1852-1870
Directoire . . . . . 1795-1799	
Consulate . . . . . 1799-1804	
EMPIRE	THIRD REPUBLIC
Napoleon I. (+ 1821) . . . . . 1804-1814	Government of National Defence . . . . . 1870-1871
HOUSE OF BOURBON RESTORED	Louis A. Thiers, Pres. . . . . 1871-1873
Louis XVIII . . . . . 1814-1824	Marshal MacMahon . . . . . 1873-1879
Charles X. (+ 1836) . . . . . 1824-1830	F. J. P. Jules Grévy . . . . . 1879-1887
	M. F. Sadi Carnot . . . . . 1887-1894
HOUSE OF BOURBON-ORLEANS	Casimir-Perier (June—Jan.) . . . . . 1894-1895
Louis-Philippe (+ 1830) 1830-1848	Félix Faure . . . . . 1895-1899
	Émile Loubet . . . . . 1899—

FRANCE, JACQUES ANATOLE THIBAUT, a French poet and novelist; born in Paris, April 16, 1844. He was the son of a bookseller; studied at Stanislas College; devoted his spare time to literary work; became attached to the library of the

Senate in 1876, and wrote for several Parisian journals. In 1868 he published a biographical study of *Alfred de Vigny*, which was followed by *Les Poèmes Dorés* (1873); *Les Noces Corinthiennes* (1876); *Jocaste* and *Le Chat Maigre* (1879); *Le Crime de Sylvestre Bonnard, Membre de l'Institut*, which received the award of the French Academy (1881); *Les Désirs de Jean Servien* (1882); *Abeille* (1883); *Le Livre de Mon Ami* (1885); *Nos Enfants* (1886); *Balthazar* (1889); *Thais* (1890); *Le Lis Rouge* (1893); *Histoire Contemporaine; L'Île d'Amour* (1899); etc. He was elected an Immortal in 1896.

FRANCE, LITERATURE OF. See FRANCE, Vol. IX, pp. 637-83.

FRANCESCA. See PIERO DE FRANCESCHI, Vol. XIX, p. 82.

FRANCHISE, a special privilege granted to an individual by the government, whereby rights are conferred which do not belong to the citizens by common right. A very common instance of such grant is the franchise or charter granted by the state to certain persons, authorizing them to engage in business as a corporation. Such method of conducting business cannot be assumed so as to make available the immunities of stockholders of a corporation and the other advantages attaching to this method of transacting business, except by special privilege of the legislature, which is extended by means of a charter. In many states it is unlawful to assume the functions or name of a corporation without a charter. City governments have the power to grant certain franchises within the limits of the city, such as the use of the streets for street-railways, electric wires, drainage, and other purposes of public use. The constitution of the United States forbids Congress or any state to abridge the right of suffrage for any reason of "race, color, or previous condition of servitude"; otherwise the right is regulated by the laws of the several states. In many states a limited right, and in some states the full right, is accorded to women. The states may impose disqualifications, as in case of paupers, criminals, etc.

FRANCILLON, ROBERT EDWARD, an English novelist; born at Gloucester, March 25, 1841; graduated at Trinity Hall, Cambridge, in 1862; and was admitted to the bar at Gray's Inn in 1864. He engaged in journalism in London, was on the editorial staff of the *Globe*, and wrote for *All the Year Round* and other periodicals. His first novel was *Grace's Engagement*, which ran in *Blackwood's Magazine* (1868). His works include *Earl's Dene* (1871); *Pearl and Emerald* (1872); *National Characteristics* (1872); *Olympia* (1874); *A Bad Bargain* (1879); *Queen Cophetua* (1880); *Quits at Last* (1883); *Face to Face* (1884); *King or Knave* (1888); *Jack Doyle's Daughters* (1894); *Ropes of Sand; Gods and Heroes*; etc.

FRANCIS I, King of the Two Sicilies; born at Naples, Aug. 19, 1777. After becoming Duke of Calabria in 1799, he succeeded his father, Ferdinand I. in 1825, the latter having consolidated the states under one government, known as the Two Sicilies. Francis, though he had, previous to his accession, made an attempt at constitu-

tional government, proved an oppressive ruler. He died in Naples, Dec. 8, 1830.

FRANCIS II, the last king of Naples, known as "Bombino"; born in Naples, Jan. 16, 1836; succeeded his father, Ferdinand II ("Bomba"), in 1859; and married, in the same year, Marie of Bavaria, sister of the late empress of Austria. He became noted for cruelty to state prisoners and for oppression of his subjects. In 1860 the Sicilians rose in insurrection; Garibaldi defeated the royalist troops in every battle, and Francis fled. He died at Arco, in the Tyrol, Dec. 27, 1894, and was buried there.

FRANCIS, DAVID ROWLAND, an American statesman; born at Richmond, Madison County,



DAVID R. FRANCIS.

Kentucky, Oct. 1, 1850. In 1866 he went to St. Louis and attended the Washington University, where he graduated in 1870. On leaving the university he at once became shipping clerk to Shryock and Rowland; and, seven years later, launched out for himself in the grain commission business, in which he continued, as president of the D. R. Francis and

Brother Commission Company. In 1883 he was elected vice-president of the Merchants' Exchange, and the following year president, after a bitter contest. He entered politics in 1884, when he was delegate-at-large to the national Democratic convention at Chicago, where he was an enthusiastic supporter of Cleveland. Next year he was nominated for mayor on the one hundred and eighty-fourth ballot. He was elected by a majority of thirteen hundred over an opponent who had, four years previously, run up a majority of fourteen thousand. In 1888 he was nominated for governor. The election resulted in favor of Francis, but by a narrow majority. When his term of office had expired, ex-Governor Francis retired from active politics. At the Democratic convention of 1896 he took a decided stand for gold. On the resignation of Hoke Smith from the Cabinet, President Cleveland, on Aug. 24, 1896, announced his choice of ex-Governor Francis to fill the vacant seat, that of Secretary of the Interior. President Cleveland, at the commencement of his second administration, had Francis in view for a Cabinet position, but the opposition in Missouri against the ex-governor was too strong.

FRANCIS, JAMES BICHENO, an American hydraulic engineer; born at Southleigh, Oxfordshire, England, May 18, 1815; emigrated to the United States in 1833; engaged in railway surveys in the East, and in 1834 was engaged in the hydraulic improvements of Lowell, Massachusetts. In 1837 he was appointed chief engineer on the locks and canals on the Merrimack River. He was the originator of many improvements in hy-

draulic works, the results of his experiments being embodied in *Lowell Hydraulic Experiments*, published in 1855, republished in 1868, and again in 1883. He also wrote *The Strength of Cast-iron Columns* (1865); was president of the American Society of Civil Engineers, 1880 to 1881, and was a member of the commission appointed to examine into the Johnstown flood. He died in Boston, Sept. 18, 1892.

FRANCIS, JOHN MORGAN, an American journalist and diplomatist; born at Prattsburg, New York, March 6, 1823; apprenticed to a printer; in 1843 became editor of the *Wayne Sentinel*, published at Palmyra, New York; in 1845 an editorial writer on the *Rochester Advertiser*; and the next year on the *Troy Budget*, of which he became editor and part proprietor. In 1851 he established the *Troy Times*. In 1851-55 he was city clerk of Troy; was a member of the New York constitutional convention (1867-68); was appointed by President Grant United States minister to Greece in 1871, resigning in 1873; was minister to Portugal (1882-84); and to Austria-Hungary (1884-85). Died in Troy, N. Y., June 18, 1897.

FRANCIS, JOHN WAKEFIELD, an American physician and medical writer; born in New York City, Nov. 17, 1789; apprenticed to a printer; graduated at Columbia College in 1809; graduated in medicine at the College of Physicians and Surgeons in 1811; was associated with Dr. Hosack in editing the *American Medical and Philosophical Register*, a quarterly which had an existence of four years. He was professor of materia medica in the College of Physicians and Surgeons; then in Columbia College; and continued professor when these two institutions were united. In 1816 he went to Europe. On his return he resumed his professorial duties at Columbia and then at Rutgers College, an institution formed by the professors of Columbia, who had resigned in a body. Rutgers College was continued until 1830, when it was closed by the legislature. His services were much sought after in all medical, literary and typographical societies. His published works include a wide range of subjects. Among them are *Notice of Thomas Eddy*; *The Anatomy of Drunkenness*; and *Old New York; or, Reminiscences of the Past Sixty Years* (1857, enlarged with a memoir, 1855). He died in New York City, Feb. 8, 1861.

FRANCIS, JOSEPH, an American inventor; born in Boston, March 12, 1801. He early developed a genius for boat-building, receiving a prize from the Massachusetts Mechanics' Institute for a fast rowboat. He furnished lifeboats to the government from his yard in New York City. In this class of boats he made many radical improvements. His "hydrogen lifeboat" was of wood, fitted with copper air-tubes. Later he replaced the wood with iron, and was thus the first to produce a metallic floating vessel. He also had the spaces at the bow and stern made into air-tight compartments. In 1842 he produced the corrugated metallic life-car. The government refused to countenance this design, but he placed a boat,

so constructed, on the coast of New Jersey, near Long Branch, in 1849; and in January, 1850, it was the means of saving 200 persons from the ship *Ayrshire*. This boat is now preserved as a relic in the National Museum at Washington. Mr. Francis invented numerous life-saving devices, which have been adopted by the American and foreign governments. He has received many foreign decorations and medals, as well as diplomas, from life-saving societies abroad. Congress voted him its thanks and awarded him a medal, which was struck in 1888. He published *Life-Saving Appliances* (1885). He died at Cooperstown, Otsego Lake, New York, May 10, 1893.

FRANCIS FERDINAND, of Austria, the heir to the throne of Austria; born at Gratz, Dec. 18, 1863. He is the eldest son of Archduke Charles Louis (brother to the Emperor Francis Joseph of Austria) and the Princess Maria Annunciata, daughter of King Ferdinand II of Naples. He inherited the fortune of his relative, the Grand Duke of Modena, taking the name of Este on doing so. His father became heir presumptive to the throne on the suicide of the Emperor's son, Prince Rudolf, which occurred January 30, 1889. But the Archduke Charles Louis renounced his rights of succession to his son, Francis Ferdinand. The latter, on thus becoming heir to the throne, renounced his fortune and name of Este to his younger brother, the Archduke Otho, who was born April 21, 1865. The Archduke Francis Ferdinand started on a tour of the world in 1892, and was everywhere warmly received, but he is seldom seen in society.

FRANCIS JOSEPH I, Emperor of Austria and King of Hungary; born Aug. 18, 1830, and succeeded to the throne of Austria, Dec. 2, 1848, on the abdication of his uncle, Ferdinand I. In April, 1854, he married the Princess Elisabeth, daughter of Duke Maximilian Joseph of Bavaria. Their son, the Crown Prince Rudolf, born in 1858, married in 1881, the Princess Stéphanie of Belgium, and committed suicide Jan. 30, 1889. The heir presumptive to the throne is



FRANCIS JOSEPH I.

FRANCIS FERDINAND (q.v., above). Francis Joseph, on ascending the throne, promised to govern as a constitutional monarch, but almost immediately dissolved the National Assembly and assumed absolute power. Rebellion in Hungary was put down with the help of Russia, and the Italian provinces were held by the iron hand of Radetsky. The Austrian Emperor remained neutral during the Crimean War. In 1855 he signed a concordat with the pope, giving the clergy full power over education. In 1859 occurred the war with France and Italy, when Francis Joseph took the field in person. The de-

cisive Austrian defeats of Magenta and Solferino led to the treaty of Villafranca, by which Austria lost Lombardy. In the spring of 1864 the Austrians and Prussians combined to rob Denmark of the Schleswig-Holstein duchies, and the quarrel over the spoils led, in June, 1866, to war between Austria and the combined forces of Prussia and Italy. The Seven Days' War, which ended at Sadowa, broke the power of Austria. By the treaty of Prague, Francis Joseph gave up to Italy all Venetia and the fortresses of the Quadrilateral, and surrendered to Prussia the duchies and all claim to control in Germany. In 1865 the Emperor adopted a policy of conciliation toward Hungary, and on June 8, 1867, he was crowned king of that country. A more liberal form of government was granted to the dual monarchy, a civil marriage bill was passed, and in July, 1870, the concordat was suspended. Since that time Francis Joseph has reigned as a constitutional monarch, though his Empire has long been distracted by race-strifes and by the acrimonious struggles of political parties. On Dec. 2, 1898, the Austro-Hungarian people celebrated the jubilee of their monarch's accession to the throne; but to the Emperor the fête was sadly marred in consequence of the tragic death of his wife, by the hand of an assassin-anarchist at Geneva in the previous September.

FRANCO-GERMAN OR FRANCO-PRUSSIAN WAR. See GERMANY, Vol. X, pp 503-505, 465, 466; and ALSACE, Vol. I, p. 637.

FRANCONIA MOUNTAINS, a cluster of the White Mountains, in Grafton County, New Hampshire, separated from the rest by the White Mountain Notch. The scenery is very fine, and the region is full of beautiful little lakes. The highest point is Mt. LaFayette (5,290 feet).

FRANK, FRANZ HERMANN REINHOLD, a German theologian; born at Altenberg, March 25, 1827. After studying at Leipsic he was appointed a professor at Erlangen. He was noted for his theological works, which include *Die Theologie der Konkordienformel* (1858-65); *System der Christlichen Gewissheit* (1870-73, translated into English and published in 1886); *System der Christlichen Sittlichkeit* (1884-87); *Vademecum für Angehende Theologen* (1892).

FRANKALMOIN. See REAL ESTATE, Vol. XX, pp. 305-307.

FRANKFORT, a city and the capital of Clinton County, central Indiana, 40 miles N. W. of Indianapolis, on four separate railroad lines. It is in a fertile farming region, receives its gas-supply from natural wells, publishes six newspapers, has car-shops, but its principal industries are farming and shipping. Population 1900, 7,100.

FRANKFORT, a city of Marshall County, northeastern Kansas, on the Vermilion River and on the Missouri Pacific railroad, 68 miles W. of Atchison. It is in a grain-raising section, has good water-power, and a manufactory of washing-machines. Population 1900, 1,167.

FRANKFORT, a city of Franklin County, central northern Kentucky, county and state



capital, situated on the Kentucky River (navigable) and on the Kentucky Midland and Louisville and Nashville railroads, 60 miles E. of Louisville. It is in a region noted for its scenery, and has beautiful drives. Its educational institutions include good public schools, a young ladies' seminary, a school for training feeble-minded children and the Kentucky Military Institute. In the neighborhood are raised fine thoroughbred trotting-horses. The manufactories of the town include those of cotton goods, lumber, twine, whisky, pottery, barrels and carriages. Population 1890, 7,892; 1900, 9,487.

FRANKFORT, a village of Benzie County, northwestern Michigan (Lower Peninsula), on Lake Michigan, and on the Ann Arbor railroad, 28 miles N. of Manistee. It is situated in a fruit-growing district, has excellent transportation facilities and a good harbor. It has numerous and large lumber, shingle and planing mills. Its mineral springs, too, have some repute. Population 1900, 1,465.

FRANKFORT, COUNCIL OF. See CREEDS, Vol. VI, pp. 562, 563.

FRANKING PRIVILEGE, a right enjoyed by government officers of sending letters and packages by mail free. The privilege belonged to members of the British Parliament from about 1660 till 1840, and, owing to the high rate of postage, was greatly abused. It was abolished on the establishment of penny postage. In America it was first granted by Congress in 1776, to private soldiers actually in service, and was gradually extended to Senators, members of Congress, secretaries, bureau officers, postmasters, delegates, etc. The matter thus franked covered not only letters and newspapers, but also public documents, executive papers and printed matter, the privilege being practically unlimited. Various partial reforms were, from time to time, attempted by legislation, and on Jan. 31, 1873, an act was passed entirely abolishing the franking privilege. But by act of March 3, 1875, the franking privilege was restored to members of the existing Congress, enabling them to send free the public documents, seeds and reports of the Agricultural Department. By act of Feb. 27, 1877, special stamps were provided, but in March of the same year these were abolished, and official "penalty envelopes" (three hundred dollars penalty for their use for private matter) authorized, in which all public documents might be sent free by Senators, Representatives, the secretary of the Senate and the clerk of the House. In 1879 the use of penalty envelopes was extended to all officers of the government, except pension agents. Special franking privileges were granted to Lucretia R. Garfield, widow of President James A. Garfield, and to Julia D. Grant, widow of Ulysses S. Grant, by which all mail matter carried to or sent by them under their respective written autographs is carried free during their natural lives. By act of Jan. 12, 1895, the franking privilege was further extended to the Vice-President, to all members and members elect of Congress, and to

all delegates and delegates elect to Congress. These may send any mail matter free to any government official, and may send free, to any person, correspondence not exceeding one ounce in weight. But every such letter must have upon the envelope the word *free* and the name and initials of office of the person holding the frank. The frank holds good for Mexico and Canada, but for no other foreign countries.

FRANKLAND, EDWARD, an English chemist; born near Lancaster, Jan. 18, 1825. He was appointed professor of chemistry in Owens College in 1851, Bartholomew's Hospital in 1857, the Royal Institution in 1863, the Royal College of Chemistry in 1865, and the Normal School of Science, South Kensington, in 1881. The latter position he resigned in 1885. He was elected a fellow of the Royal Society in 1853, a corresponding member of the French Academy in 1866, and afterward of other learned bodies. He collected many of his papers in *Experimental Researches in Pure, Applied and Physical Chemistry* (1878), and published manuals, lectures, and works on lighting, sanitation, etc. Died in London, Aug. 13, 1899.

FRANKLAND, PERCY FARADAY, an English chemist, a son of Edward Frankland; born at South Hampstead, Oct. 3, 1858; educated at the Royal College of Science, South Kensington, at Würzburg University and at London University. In 1880 he was appointed demonstrator of chemistry in the Royal School of Mines; in 1889 he came professor of chemistry in University College, Dundee, Scotland, which is now an integral part of the University of St. Andrews. His chief work has been in the chemical and hygienic applications of bacteriology. He demonstrated the efficacy of a sand-filter for water, the result of his experiments being embodied in a paper, *Water Purification: Its Biological and Chemical Basis*, published by the Institution of Civil Engineers. He devoted great attention to the chemical changes effected by micro-organisms, especially in regard to nitrification and denitrification. In 1892 he delivered a course of Cantor lectures, his subject being *Recent Contributions to the Chemistry and Bacteriology of the Fermentation Industries*. In 1894 he was appointed to the chair of chemistry at Mason College. He was the author of *Our Secret Friends and Foes*, published in the Romance of Science Series; *New Micro-organisms Obtained from the Air* (1887); and *Micro-organisms in Water*, a large work produced, in conjunction with his wife, in 1892.

FRANKLIN, a city and the capital of Johnson County, south-central Indiana, 21 miles S. of Indianapolis, on the Cleveland, Cincinnati, Chicago and St. Louis and Pittsburg, Cincinnati, Chicago and St. Louis railroads. It has a college, expensive school buildings, saw-mills and flouring-mills. Population 1890, 3,781, 1900, 4,005.

FRANKLIN, a town and the capital of Simpson County, central southern Kentucky, 51 miles N. of Nashville, on the Louisville and Nashville railroad, in a farming and stock-raising section. It has two colleges (one for men and one for

women), a woolen factory, a tobacco factory, planing and flour mills. Population 1900, 2,166.

FRANKLIN, a town and the capital of St. Mary's Parish, central southern Louisiana, on the Bayou Teche and the Southern Pacific railroad, 85 miles W. of New Orleans. It is in a great sugar belt. Steamers can ascend the river, and the place has good trade facilities; its exports are, mainly, sugar, oranges and cotton. Population 1890, 2,127; 1900, 2,692.

FRANKLIN, a town of southern Norfolk County, eastern Massachusetts, 28 miles S.W. of Boston, on the New England railroad, it contains Deane Academy, a public library, manufactories of pianos, straw, cotton and woolen goods, a canning factory and a foundry. Population 1890, 4,831; 1900, 5,017.

FRANKLIN, a village of northern Merrimack County, central New Hampshire, 24 miles above Concord, on the Boston and Maine and Franklin and Tilton railroads, and at the union of the Pemigewasset and Winnepesaukee rivers, which unite here to form the Merrimack. It has a paper-mill, woolen-mills, machine-shops and wood-working shops. Pop. 1890, 4,085; 1900, 5,846.

FRANKLIN, a village of Warren County, southwestern Ohio, 35 miles N.N.E. of Cincinnati, on the Miami River, and on the Cincinnati, Jackson and Mackinaw and Cleveland, Cincinnati, Chicago and St. Louis railroads, and on the Miami and Erie canal. It has five paper-mills, two wood-pulp mills, and three large tobacco warehouses, besides a few smaller factories. Population 1890, 2,729; 1900, 2,724.

FRANKLIN, a city and the capital of Venango County, northwestern Pennsylvania, situated on the Allegheny River, at the mouth of French Creek, and on the Western New York and Pennsylvania, the Lake Shore and Michigan Central and other railroads. It has oil-refineries, machine-shops, carriage factories, flour-mills, forging-mills, planing-mills, and other industries. The streets are paved and the city has a good system of sewers. Population 1890, 6,221; 1900, 7,317.

FRANKLIN, a town and the capital of Williamson County, central Tennessee, on the Harpeth River, 18 miles S. of Nashville, and on the Louisville and Nashville railroad. It contains a Masonic temple, Tennessee Female College and Harpeth Male Academy; among its business establishments are carriage manufactories, steam cotton-gins, a planing-mill, flour-mills and a furniture factory. Two battles of the Civil War were fought here—April 10, 1863, and Nov. 30, 1864. Population 1900, 2,180.

FRANKLIN, BATTLE OF. After the Chattanooga campaign had ended, and General Grant had been made commander-in-chief of the Federal armies, General Sherman withdrew his army from Hood's front and started upon his march to the sea. Lee was confronting Grant at Richmond, and, to hold all the country which had been wrested from the Confederacy between the Mississippi and Chattanooga, Sherman had left Thomas with a force only slightly exceeding 20,000 men. These

men were scattered at various points in the region indicated, and to operate against them Hood had a force numbering more than twice as many. His army had been reinforced, and the Confederate government was contemplating a move on the Ohio, and an invasion of the territory held by the Union troops. In addition to Hood's army, Kirby Smith had been ordered to bring up his command from west of the Mississippi, in order to force to a successful conclusion this invasion. The value of a Confederate victory at this time would have been particularly great, as it would, it is believed by many, have had the effect of securing an alliance between the French, who were then occupying Mexico, and the Confederate States, if, indeed, it had not secured the co-operation of other European powers. The bulk of Thomas's army under General Schofield, numbering 18,000 men, was strung out in a line 50 miles in length, reaching from Pulaski to Centerville, on Duck River. General Schofield had received instructions from General Thomas, in the event of Hood's attempt to turn his flank, to fight at Columbia; but if the attack was made in another direction, to fight at Pulaski. Between Hood and Nashville the only Union forces were four small cavalry brigades. Thomas's object was to delay Hood until he could concentrate the Union army at some given point and receive reinforcements both of recruits and of the army in Missouri under the command of A. J. Smith. The outlook for the Federal army was very serious, for there was not only a great disparity of numbers, but, on account of the scattered condition of Thomas's troops and the number of important posts to be held, it was a work of great difficulty, owing to the state of the weather and condition of the roads, to move troops to any common point. Hood lay on the south bank of the Tennessee, in command of the crossing at Florence. He advanced to the north bank, and, pushing forward, forced Schofield back on Columbia, and, while feigning a direct attack upon the Union front, threw seven divisions of infantry and a heavy force of cavalry over Duck River, and succeeded in attaining the Union rear. The destruction or capture of the Union army seemed certain, but the errors of Hood's division commanders and the determined resistance of General Stanley's (Federal) command enabled Schofield to fall back upon Franklin, to which point he was directed by General Thomas to retire. After crossing the river, Hood moved at daybreak, with his seven divisions, to Spring Hills, twelve miles in Schofield's rear, and on his line of retreat to Franklin. As Hood entered the place from the west, General Stanley, with one division of the old army of the Cumberland, came up from the south. Schofield's troops were strung out for a distance of twelve miles, and encumbered with wagon trains. Stanley made a gallant fight from early in the afternoon till seven p. m., holding the Confederates in check for seven hours, giving Schofield time to bring up his scattered forces. As night fell, however, matters did not seem improved for the Union

forces, for there were seven divisions of the Confederate army on its front and flank and two in its rear. But, under cover of Stanley's determined stand, the army succeeded in retreating in safety as far as Franklin, where a stand was made, a portion of the Union army facing about, and where was fought one of the most remarkable conflicts of the entire four years. The Union forces were posted in a single intrenched line, with only one brigade in reserve, and with two brigades stationed in the open field, covered by a slight breastwork a third of a mile in front of the main line. Their flanks rested on the Harpeth River, and the intention was to cover the crossing of the trains, and to hold the enemy in check until night should allow the whole force to withdraw under cover of darkness. When Hood's army came up, it was formed in column of attack, and at once moved down in good order and in overwhelming numbers on the Union position. The two advanced brigades were enveloped and brushed away—forced back over the intrenchments, both armies amalgamating in a confused mass. Federal batteries were seized and turned so as to enfilade the Union lines. Fortunately, one of the retreating brigades, as it was driven over the parapet, turned, and, firing a volley upon the Confederates, manned part of the vacated works. Then the reserve brigade was ordered to charge by its immediate commanding officers, and, although suffering fearfully, drove the Confederates at the point of the bayonet back over the works. The Union guns were retaken and turned on the Confederates with fearful effect. Several times did Hood's charging columns endeavor to dislodge the Federals, but in vain, and when night fell upon the scene Hood had lost over seventeen hundred men killed, including five generals, and four thousand wounded, among whom were six generals. The Union loss was stated to be fifteen hundred.

The remainder of the army having crossed the river by this time, the forces which had been engaged in the conflict were, under cover of darkness, withdrawn within the defenses of Nashville, where, a short time after, Hood was totally defeated by Thomas. The date of the battle of Franklin was Nov. 30, 1864.

FRANKLIN, STATE OF. See TENNESSEE, Vol. XXIII, p. 178.

FRANKLIN, THOMAS LEVERING, an American clergyman; born in Philadelphia, April 10, 1822; graduated at Trinity College, Hartford, in 1841; ordained a deacon in the Protestant Episcopal Church in 1844; was on missionary committees in New York state, and active in promoting the building of churches and rectories; filled important pastorates in the church, and, later, had charge of the City Mission, Philadelphia. He founded, in 1866, the Jane Grey School, at Mount Morris, New York, and was its rector from 1866 to 1870. He published *The Creed*, tracts on *Divorce*, and was editor of *The Episcopal Register* for six years.

FRANKLIN, WILLIAM, the last royalist governor of New Jersey; born in Philadelphia in 1729. He was the illegitimate son of Benjamin Franklin,

who, marrying the year after the birth of his son, took the latter into his home and brought him up. In the French war of 1744-48, the son took an active part, and rose to be a captain before he came of age. He then occupied local offices, and accompanied his father to England, where he became acquainted with Lord Fairfax (see FAIRFAX, JOHN CONTEE, in these Supplements), upon whose recommendation he was made governor of New Jersey in 1762. He then became a Tory, and throughout the Revolution remained loyal to his British patrons. The new American government declared him an enemy of the country and put a guard over him. In 1782 he went to England, Great Britain granting him compensation for his losses, and a handsome pension. He died in England, Nov. 17, 1813. See also FRANKLIN, Vol. IX, p. 718.

FRANKLIN, WILLIAM BUEL, an American soldier; born in York, Pennsylvania, Feb. 27, 1823; graduated at West Point in 1843, and was assigned to the corps of topographical engineers. He was brevetted lieutenant for gallantry at Buena Vista, and became captain in 1857. In May, 1861, he was appointed colonel of the Twelfth United States Infantry; received a brigadier-general's brevet in June, 1862, and that of major-general in March, 1865. He became brevet brigadier-general of volunteers in May, 1861, and brigadier-general in July, 1862. He commanded a brigade at Bull Run, and led the Sixth Army Corps through the peninsula. He was engaged at South Mountain, and commanded the left grand division at Fredericksburg, Dec. 13, 1862. Burnside removed him for alleged insubordination, but the President did not approve the order of removal, and Burnside resigned his command. Franklin was given command of the Nineteenth Army Corps, took part in the Red River expedition, and was wounded, April, 1864, and obliged to leave the army. He resigned in 1866 and engaged in the manufacture of firearms. In 1880 he became president of the board of managers of the National Soldiers' Home. He was United States commissioner to the Paris exposition of 1889, and that year received the insignia of grand officer of the Legion of Honor.

FRANKLIN AND MARSHALL COLLEGE, an institution for the higher education of men, situated at Lancaster, Pennsylvania, and controlled by the German Reformed Church. It is a continuation of two older institutions: Franklin College, founded in 1787, at Lancaster, Pennsylvania, and named for Benjamin Franklin, who largely endowed it, and Marshall College, established in 1836 at Mercersburg, Pennsylvania, by the Reformed Church. The two institutions were consolidated in 1852, under the present name. A theological seminary is conducted in connection

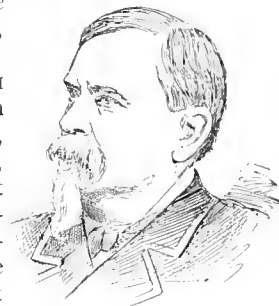

GEN. WILLIAM B. FRANKLIN.

with the collegiate course. The endowment of the college in 1895 was about \$490,000 and the



THE ACADEMY, FRANKLIN AND MARSHALL COLLEGE.

income about \$12,000. In 1895 there were 325 students in attendance, with 22 in the faculty and a library of 29,000 volumes.

FRANKLINIA, an old generic name given to *Gordonia pubescens*, a shrub or small tree of Georgia and Florida, of the family *Ternstroemiaceae*, allied to the camellias and tea-plants. It is much prized as an ornamental evergreen, and for its beautiful, large white flowers.

FRANKLIN ISLAND, off the coast of Knox County, central southern Maine, lies on the west side of the entrance of St. George's River. There is a brick lighthouse at its northern point. Lat. 43° 53' 31" N., long. 69° 22' 10" W.

FRANKLINITE. See IRON, Vol. XIII, p. 287; MINERALOGY, Vol. XVI, p. 386; and ZINC, Vol. XXIV, p. 784.

FRANKLIN LAKE, in Elko County, north-eastern Nevada, on the east side of the East Humboldt Mountains. It is nearly fresh, very shallow, and has no outlet. The tule (*Scirpus validus*) grows abundantly in the lake.

FRANKLINVILLE, a village of Cattaraugus County, southwestern New York, on the Allegheny River, and on the Western New York and Pennsylvania railroad, 42 miles S.S.E. of Buffalo. It is the center of a large dairying district; has a coffin factory, saw and grist mills, a creamery and canning factory. The village has city water and electric lights. Population 1890, 1,021; 1900, 1,360.

FRANK-MARRIAGE. See SETTLEMENT, Vol. XXI, p. 694.

FRANK-PLEDGE, a custom prevailing in England before the Norman Conquest, whereby the freemen of a neighborhood were responsible for the good conduct of each other. Ten men formed an association, called a tithing, in which the ten were answerable each for the others, so that if one committed an offense, the other nine were liable for his appearance to make reparation. Should the offender abscond, the members of the tithing, if unable to clear themselves from participation in the crime, were compelled to make good the penalty.

FRANKS, SIR AUGUSTUS WOLLASTON, English archæologist; born at Geneva in 1826; graduated

at Trinity College, Cambridge, in 1849. In 1851 he entered the service of the British Museum; and in 1866-96 was keeper of the department of British and Mediæval antiquities and ethnography. He presented to the Museum his unique collection of Chinese and Japanese porcelains and pottery, and his specimens of Italian majolica and other wares. He was regarded as one of the greatest authorities on the arts of the Renaissance and Oriental ceramics, and was president of the Society of Antiquaries. He published *Ornamental Glazing Quarries* (1849); *Recent Excavations and Discoveries on the Site of Ancient Carthage* (1860); edited *Hours Ferales*, by J. M. Kemble (1863); *Japanese Pottery* (1880). Died in London, May 21, 1897.

FRANZ, ROBERT, a German composer; born at Halle, June 28, 1815; studied under Schneider at Dessau, and in 1843 published a set of twelve songs which won the warm praises of Schumann, Mendelssohn, Liszt and other masters. He was organist of a church at Halle, and was very active in the department of church music. He was also professor in the Conservatory of Music, and conducted large concerts. He published over 250 songs for single voices, a Kyrie, and several chorals and four-part songs, besides arrangements of the masterpieces of Bach and Handel. In 1877 he was obliged by deafness to give up his various positions, and to discontinue his musical work. He died in Halle, Oct. 24, 1892.

FRANZOS, KARL EMIL, a German author; born, of Jewish parentage, Oct. 25, 1848. His chief power as a writer lay in ethnographical description, especially in the form of romance. His works have been translated into almost every European language. The translations of *The Jews of Barnow* and *A Fight for the Right* attracted special attention in England.

FRASER, ALEXANDER, a British artist, was born in 1827, at Woodcockdale, near Linlithgow. Early showing a taste for art, he received his first instruction from his father, an able amateur. His first appearance in the Scottish Academy Exhibition was with a figure-picture, *A Gipsy Girl in Prison*. But he soon abandoned the figure for landscape. Among his works of this class are *The Margin of the Forest*; *In Glen Arnan*; *Trout Stream in the West Highlands*; etc.

FRASER, ALEXANDER CAMPBELL, a Scottish metaphysician; born at Ardchattan, Argyleshire, Sept. 3, 1819, and educated at the universities of Glasgow and Edinburgh. He became a Free Church minister; from 1850 to 1857 he was editor of *The North British Review*; in 1856 succeeded Sir William Hamilton in the chair of logic and metaphysics at Edinburgh University; and in 1859 became dean of the faculty of arts. In 1856 he published *Essays in Philosophy*. His edition of Berkeley's works, in four volumes, with dissertations and annotations, a life of the bishop and an account of his philosophy was issued by the Clarendon Press in 1871; *Selections from Berkeley* in 1874; and in 1881 his monograph on *Berkeley* was published in Blackwood's Philosophical Classics, to which series he also contributed *Locke*

(1889). The article on JOHN LOCKE, in this ENCYCLOPÆDIA, was written by him.

FRASER, CHRISTOPHER FINLAY, a Canadian politician; born in Brockville, Ontario, in 1839; admitted to the bar in 1865, entered the legislature of Ontario in 1872; was provincial secretary and registrar; and in 1874 became commissioner of public works.

FRASER, DONALD, a Scotch Presbyterian minister; born at Inverness, Scotland, Jan. 15, 1826; graduated at Aberdeen University in 1842; studied theology at Knox College, Toronto, Canada, and at New College, Edinburgh; was Presbyterian minister at Montreal from 1851 to 1859; at Inverness, Scotland, from 1859 to 1870; and Marylebone Church, London, 1870. He was the author of *Leaves from a Minister's Portfolio* (1858); *Synoptical Lectures on the Books of Holy Scripture* (1886); *The Church of God and the Apostacy* (1872); *Thomas Chalmers* (1881); *The Speeches of the Holy Apostles* (1882); *Metaphors in the Gospels* (1885); *Sound Doctrine* (1892).

FRASER, JAMES, an English bishop; born at Prestbury, near Cheltenham, in 1818; died Oct. 22, 1885. He graduated at Lincoln College, Oxford, in 1839, and in 1840 was elected to a fellowship at Oriel. Ordained in 1846, he held the living of Cholderton, Wiltshire, from 1847 to 1860, and that of Ufton Nervet, near Reading, from 1860 to 1870. In 1870 he was consecrated bishop of Manchester. He was, for some years, commissioner of education, and published valuable reports on elementary education in England, on the educational systems of the United States and Canada, and on the employment of children. He also published a number of sermons, and two volumes appeared posthumously (1887).

FRASER, SIMON. See LOVAT, LORD, Vol. XV, p. 27.

FRASER, THOMAS RICHARD, an English medical scientist; born at Calcutta, Feb. 5, 1841; graduated at the University of Edinburgh in 1862; next year was appointed assistant to the professor of materia medica in that university; and, after various medical appointments, succeeded to the chair, on the death of Sir Robert Christison in 1877. In 1878 he became professor of clinical medicine, and in 1880 dean of the medical faculty. His activity has lain chiefly in the direction of investigating the physiological effects of medicinal substances, with the object of establishing accurate procedure in the treatment of disease. The results of his researches have been published in scientific journals, the titles of some of them being *Characters, Actions and Therapeutic Uses of Physostigma Venenosum* (1863); *The Physiological Action of Physostigma* (1866); with Professor Crum Brown, *On the Connection between Chemical Constitution and Physiological Action* (1868); *Researches on the Antagonism between the Actions of Physostigma and Atropia* (1870); *The Dyspnea of Asthma and Bronchitis: Its Causation and the Influence of Nitrites Thereon* (1887); *Strophanthus Hispidus: Its Natural History, Chemistry and Pharmacology* (1889); etc.

FRASER RIVER. See COLUMBIA, BRITISH, Vol. VI, p. 169; and PACIFIC OCEAN, Vol. XVIII, p. 116.

FRATERNAL INSURANCE SOCIETIES. See FRIENDLY SOCIETIES, Vol. IX, pp. 780-785; and BENEFIT SOCIETIES, in these Supplements.

FRATERNITY OF MODERN WOODMEN. See BENEFIT SOCIETIES, in these Supplements.

FRATTA-MAGGIORE, a town of central Campania, southern Italy, 6 miles N.W. of the city of Naples, has extensive rope-works, and furnishes great quantities of strawberries, also silkworms. Population, 10,800.

FRAUDS, STATUTE OF. The English statute known as the Statute of Frauds has been enacted, as to most of its provisions, in almost every state of the United States. The object of the statute is to require that contracts of certain kinds, or some memorandum thereof, shall be made in writing, so that the great opportunities which were formerly open for the practice of fraud concerning such contracts shall be avoided. This statute has been fully discussed and carefully considered in all its details by the courts in the various states of the United States, and by the English courts. The effect of the statute is very beneficial. See FRAUD, Vol. IX, p. 726.

FRAUDULENT CONVEYANCES, such conveyances as are made with the intent to avoid some duty, and which have the effect or tendency to defraud another. Thus when one makes a voluntary conveyance, or one without valid consideration, of all his estate, or sufficient thereof, to defeat or delay his creditors, the conveyance will be considered fraudulent, and will be set aside at the suit of a creditor, and such estate held to the payment of debts. In the United States it is generally held that a conveyance made upon a good consideration, that is, love and affection, and the like, will be held valid as between the parties and as to creditors whose debts were incurred subsequent to the conveyance and with notice thereof, but will be set aside as to subsequent creditors without notice of the conveyance at the time of extending the credit, and as to all creditors whose claims were incurred prior to the conveyance. In many states conveyances made for a valuable consideration are considered fraudulent, if the consideration is wholly inadequate, and the purchaser will be held for the balance of the value of the estate. Fraud will generally be presumed when no valuable consideration passes, and sufficient property is not retained with which to pay all debts. The English statutes on this subject have been extensively adopted throughout the United States, and many decisions have been rendered by the courts in both countries concerning them. See FRAUD, Vol. IX, p. 726.

FRAXINELLA, the common name of *Dictamnus Fraxinella* or *D. alba*, a plant of the family *Rutaceæ*, native of southern Europe and cultivated for ornament. It is an herb with woody base, with ash-like leaves, terminal clusters of large purple or white flowers, and the whole plant with a strong aromatic fragrance.

**FRAZER, JOHN FRIES**, an American scientist; born in Philadelphia, July 8, 1812. He acted as laboratory assistant to Prof. Alex. D. Bache, and was afterward connected with the Pennsylvania survey. He studied medicine and law, and in 1844 he became professor of chemistry and natural philosophy in the University of Pennsylvania, with which he was connected until his death. From 1850 to 1866 he edited the Franklin Institute *Journal*. He was a member, secretary and vice-president of the American Philosophical Society, and one of the original members of the National Academy of Sciences. He died in Philadelphia, Oct. 12, 1872.—His son, **PERSIFOR FRAZER**, also a chemist, was born in Philadelphia, July 24, 1844; served in the United States army and navy during the Civil War, and in 1869 became connected with the United States Geological Survey. In 1870 he was appointed professor of chemistry in the University of Pennsylvania, and later held a similar position in the Franklin Institute. In 1882 he received the degree of doctor of sciences from the University of France. He was a member of many home and foreign scientific societies.

**FRAZIER'S FARM, BATTLE OF**, occurred during the Civil War in the United States, June 30, 1862. Early in the morning, the army of the Potomac, under McClellan, crossed White Oak Swamp, in the eastern portion of Henrico County, Virginia, while a part of the army in advance had reached the James River. The Confederates, under Generals Jackson and Longstreet, in two columns, had designed and endeavored to intercept McClellan, who was advancing along the Quaker Road. Longstreet hastened along, but found, when he reached the junction of the Quaker and Newmarket roads, that the enemy was there in possession. Longstreet, anxious to pierce McClellan's line, without waiting for Jackson, attacked McCall's division. He failed in his design, though the attack was made with great impetuosity. McClellan reached Malvern Hill, and was able to re-establish communication with the James River the next day.

**FRECHETTE, LOUIS HONORÉ**, a Canadian journalist; born in Quebec, Nov. 16, 1849. He was for many years connected with the press of Canada. He resided in Chicago from 1866 until 1871; returned to Canada, and was elected in that year to the Dominion Parliament for the county of Levis. In 1884 he became chief editor of *La Patrie*, Montreal. He is known as a graceful poet. His two volumes, *Les Fleurs Boréales* and *Les Oiseaux de Neige*, were "crowned" by the French Academy in 1880. Among his other works are, poems: *La Voix d'un Exilé* (1869); *Pêle-Mêle* (1877); *La Légende d'un Peuple* (1887); *Les Feuilles Volantes* (1892); prose: *Lettres à Bastille* (1871); *Histoire Critique des Rois de France* (1893); *Lectures sur l'Éducation* (1893); and *Vieux Cartons* (1893).

**FRECKLES**. See ANATOMY, Vol. I, p. 897.

**FREDEGARIUS**. See NARSES, Vol. XVII, p. 234, note.

**FREDERIC, HAROLD**, novelist and journalist; born in Utica, N. Y., Aug. 19, 1856; received a grammar-school education, and at the age of 12 went to work upon a farm. In 1876 he became a proofreader on the *Utica Observer*, and in 1882 was called to the editorship of the *Albany Journal*. In 1884-98 he was the London correspondent of the *New York Times*, a position which he filled with signal ability. He wrote *Seth's Brother's Wife* (1887); *The Lawton Girl* (1890); *In the Valley* (1890); *William II* (1891); *The Young Emperor* (1892); *The New Exodus: A Study of Israel in Russia* (1892); *The Return of the O'Mahony* (1892); *The Copperhead* (1893); *Marsena* (1894); *The Damnation of Theron Ware (Illumination)* (1895); *March Hares* (1896); *Gloria Mundi* (1898); *The Deserter, and Other Stories* (1898); *The Market Place* (1899). Died at Henley, Eng., Oct. 19, 1898.

**FREDERICK**, a city and the capital of Frederick County, north-central Maryland, 32 miles N.W. of Washington, on the Pennsylvania and Baltimore and Ohio railroads. The surrounding country is fertile and hilly, and has copper and iron mines and slate and limestone quarries. It has two seminaries for women, Frederick College (founded 1797), and a state deaf and dumb asylum. Near here are two battlefields, Monocacy and South Mountain. In Mount Olivet cemetery is buried Francis S. Key, who was a native of the county. Its industries are shipping, canning, lumber, planing and tanning and the manufacture of coaches, shoes, flour, hose and spokes. Population 1890, 8,193; 1900, 9,296.

**FREDERICK, EMPRESS**. See FREDERICK III, below, in these Supplements.

**FREDERICK III**, King of Prussia (Frederick I of Germany), familiarly known as "Unser Fritz" while he was the Crown Prince of Prussia. He was the son of Emperor William I of Germany, and was born at Potsdam, Oct. 13, 1831. He was an interested witness of the scenes of the revolution of 1848, and it is more than probable that to the influence exerted by these scenes was due his liberal spirit in after years. In 1861 his father ascended



FREDERICK III.

the throne of Prussia as William I, and he was at that time a general in the army, having, all through his life, been the subject of thorough military training. He had previously married (in 1857) Princess Victoria Adelaide (born Nov. 21, 1840), the eldest daughter of Queen Victoria of England. The issue of this marriage was seven children, the eldest being the present Emperor William II, who was born in 1859. Frederick took part in the war of 1866 between Denmark and the coalition of Prussia and Austria, and also commanded one of the armies of invasion in the subsequent war between Austria and Prussia, and took a leading part in the decisive

battle of Sadowa. During the Franco-Prussian war of 1870 he commanded the army corps which invaded France through the territories of Alsace and Lorraine, and for his distinguished services he was made field-marshal general, the highest military dignity known to the Prussian service. After the war was over he returned to Berlin and was engaged in civil duties, assisting his father in the administration of the affairs of the empire (of which he had become, by the crowning of his father as Emperor, the Prince Imperial), and at this period of his life spent considerable time in foreign travel. He was not in sympathy with the extreme policy of Bismarck, but their amicable relations suffered no serious interruption. In his domestic relation he was plain, unostentatious, a good husband and a kind father, and although his entire life had been spent in the midst of soldierly and military surroundings, he was disinclined to war and was an ardent advocate of peace. He was universally beloved for his sterling qualities, and, during his last illness, was the object of more sympathy and tender solicitude than it had ever before been the lot of any sovereign to receive. In March, 1888, on the death of his father, the Emperor William I, he ascended the imperial throne, and his brief reign of three months has a melancholy interest on account of his sufferings, borne with such heroic fortitude. He was never formally crowned, on account of his physical inability to undergo the fatigue incident to the ceremony, and he died at Berlin, June 15, 1888.

**FREDERICK CHARLES NICHOLAS**, a prince and field-marshal of Germany; born in Berlin, March 20, 1828; and died June 15, 1885. He was the eldest son of Prince Charles, brother of the Emperor William I. Frederick Charles entered the Prussian army when a boy, served in the first Schleswig-Holstein war, commanded the right wing in the second Danish war, and defeated the Austrians at Königgrätz in 1866. He commanded the Second Army Corps in 1870, drove Bazaine back into Metz, and received the surrender of that fortress, Oct. 27, 1870. Thence he marched on Orleans, which he captured, defeated General Chanzy at Le Mans, and broke up the army of the Loire. He was known as the "Red Prince," from the fact that he always wore a red hussar uniform. His daughter, Louise Margaret, married the Duke of Connaught, son of Queen Victoria, in 1879.

**FREDERICK HENRY ISLAND**, a Dutch island off the southwestern coast of Papua, and separated from it by Dourga Strait. Lat. 8° S., long. 138.5° E. Area, about 400 square miles. The population is very small.

**FREDERICKSBURG**, the county seat of Gillespie County, southern central Texas, 85 miles W. of Austin, on a tributary of the Colorado River. It has flour and saw mills, an ice factory, cotton-gins and a flourishing trade in corn and wheat. It is high and healthful in situation. Population 1890, 1,532.

**FREDERICKSBURG, BATTLE OF.** After the battle of Antietam, the sentiment of opposition

in the North to General McClellan, who had failed to follow up the advantages (barren though they were) resulting from that battle, culminated in his dismissal, and subsequent supersession by Gen. A. E. Burnside as commander of the army of the Potomac. Although General Burnside had announced his incapacity for the command of so large an army, he was forced to accept, and December, 1862, found him encamped on the north bank of the Rappahannock River, with his headquarters at the Lacy House, in Stafford County. Lee's army lay on the south bank, some distance from the town of Fredericksburg, but on the first intimation that Burnside was about to attempt to cross the river he promptly advanced to the town and massed his army on the hills which surround the town in a crescent shape, the convexity, pointing to the town, being occupied by the center of Lee's army, while the left, which receded to the southwest, was held by Longstreet. Jackson held the right with 30,000 men, with Stuart on his extreme right guarding Hamilton's Crossing—a point on the range surrounding the town, which could only be approached from the river by crossing the Richmond, Fredericksburg and Potomac railroad and the narrow-gauge railroad cut—these two features of the surface of the country adding to the natural strength of the position of the Confederate army on the right. General Burnside determined to cross the river and assault Lee's army, despite the fact that valuable time had been lost by him, and Lee had had time to render his position impregnable. His division commanders and subordinates, generally, it is claimed, tried to dissuade him from making so rash an attempt, but all to no purpose. On November 7 he commenced his attempts to lay a pontoon bridge at the west end of the town, over the river, at a point between the cotton-mills, on the south bank of the river, and the Falmouth Heights, on the north. Sharpshooters in the town, however, prevented the accomplishment of this scheme, thus giving Lee additional time to perfect his arrangements, and it was not until a force had been sent across the river (at the suggestion of General Hunt), which cleared the town of Confederates, that the laying of the pontoons was successfully accomplished. In the mean time the town had been severely bombarded by the Federal batteries on Falmouth Heights, but all to no avail, so far as dislodging the Southern sharpshooters was concerned. Another bridge was simultaneously thrown over the river, at Hamilton's Crossing, to the east of the town, and then the assaulting army—divided into three divisions, under the command of Sumner, Hooker and Franklin—crossed the river and advanced on Lee's position. The crossing occupied two days, and on Dec. 13, 1862, under the cover of a dense cloud of fog and drizzle, the battle was begun.

The town of Fredericksburg lies, as has been before incidentally mentioned, at the foot of a low, crescent-shaped ridge, which rises from the rear or southern portion of the corporate limits with some abruptness, and then stretches out into

a broad table-land, extending far to the south and west. On the extreme left of Lee's army lay the Rappahannock, while on the extreme right was Hazel "run"—a small creek, or "branch," as it is called in the Southern country. Immediately in front of Lee's center lay the town, between which two points was a canal full of water, and south of the canal was a roadway winding along the side of the hill, and along the side of this road ran a stone wall or fence, behind which was posted a strong body of Confederates. To the rear of this wall, and on the top of the hill, at this point called Marye's Heights, was massed a heavy force of Confederate artillery.

Sumner and Hooker led their divisions over the pontoons on the Confederate left, while Franklin, on whom devolved the opening of the battle, crossed on the lower or eastern pontoon, and began the attack by assaulting Jackson, his men having to charge up the slope and across the railroad tracks in the face of a murderous fire. They made a gallant fight, but flesh and blood could not stand the terrific storm they encountered. The artillery of the Southern army was so stationed that it could fire over the heads of its own infantry with terrible effect, while the Union army was almost entirely deprived of the use of its artillery, the danger to their own men by its use being far greater than that to which the enemy was exposed from their fire. At the same time, the Confederate infantry, being in a position almost impregnable, had no hard task to repel the assaults which were repeatedly made by the Union forces. Meade led the charge of Franklin's division, and although he put forth almost superhuman efforts and received reinforcements, it was of no avail; nothing could be accomplished, and after having thousands of his men slaughtered, he withdrew from the fight, having accomplished nothing and lost the flower of the Federal army. On the center the slaughter of the Union troops was terrible. Sumner's division deployed through and to the west of the town, and advanced against the position held by Pickett's men. In their course they had to charge over the canal and then up a long incline to the top of the hill. About half way up the hill they encountered the fire from the troops behind the wall mentioned before. Division after division was thrown against this point, and men were mown down like grass before the sickle. One brigade,—the Irish brigade of Meagher,—in particular, suffered severely. These brave men were again and again ordered to charge and dislodge the Confederates behind the stone wall, the artillery, in the mean time, playing on them in one continuous fire. The task was hopeless, and after three fourths of the troops so engaged had been killed, the order was given to desist. When the day was over it was found that the Federals had lost over 14,000 men, while the Confederate loss had been only about 5,000.

On the next day Burnside proposed to renew the assault, and it was only at the earnest solicitations of his subordinates that he desisted.

Shortly after this battle he was, at the unanimous request of his generals of division, removed from command, and General Hooker was made his successor. Everything taken into consideration, this battle is one of the most remarkable fought during the entire course of the war. It has long been a bone of contention among the military authorities as to the circumstances which led Burnside to determine to give Lee battle under these conditions. He certainly could not have hoped to carry a position so strong as was that of the Confederate commander, and the whole affair is enshrouded with an air of mystery.

**FREDERICKTOWN**, a town, the capital of Madison Co., Mo., 105 miles S. of St. Louis. The famous Mine la Motte lead-mines are in the vicinity. Pop. 1890, 917; 1900, 1,577.

**FREDERICK WILLIAM**, Grand Duke of Baden; born at Karlsruhe, Sept. 9, 1826; succeeded his father as regent in 1852, and assumed the title of Grand Duke in 1856. On Sept. 20, 1856, he married Louise, the only daughter of William I of Prussia. He assisted Prussia materially in the war of 1870-71. In 1855, by his order, the Jesuits were excluded from the duchy.

**FREDONIA**, a city, the capital of Wilson Co., Kan., 105 miles S. of Topeka, in an agricultural and stock-raising district, which also produces limestone, slate, building-stone, fire-clay, and coal, and has a salt spring. Pop. 1900, 1,650.

**FREDONIA**, a village of Chautauqua Co., N. Y., 3 miles from Lake Erie; has been lighted by natural gas for over 40 years; has water-works, a state normal school, built by the village, costing \$100,000, an academy established in 1824, a carriage factory, and felt-pad factory. Grape-cuttings and garden-seeds are raised for sale. The first Patrons of Husbandry grange was organized here. Pop. 1890, 3,399; 1900, 4,127.

**FREDRIKSHALD**, a picturesque seaport town in Smaalene province, Norway, on the Idde fjord, 57 miles S. S. E. of Christiania; famous for its fortress Fredriksteen, at the siege of which Charles XII of Sweden was killed, Dec. 11, 1718. Has sugar-refining, linen, and tobacco factories, and trades in lumber and iron. Pop. 1891, 11,217.

**FREDRIKSTAD**, a town in Smaalene province, Norway, at the mouth of the Glommen, 48 miles S. of Christiania; was formerly a fortress; manufactures nails and exports timber. Pop. 1891, 12,451.

**FREE BAPTISTS**. See BAPTISTS IN THE UNITED STATES, in these Supplements.

**FREEBENCH**. See BENCH, Vol. III, p. 556.

**FREEBERG**, a village of Snyder Co., Pa.; has a musical college; the chief industries of the vicinity are farming and ore-mining.

**FREE CHURCH OF ENGLAND**, a Protestant Episcopal organization, founded in 1844, and enrolled in chancery, in England, in 1863, "originated as a counteracting movement to the Oxford Tractarians." It is free from state control, and therefore claims the liberty of entering a parish where ritualistic practices prevail and establishing a liturgical service, on the basis of the evangelical party in the national church, with which



its ritual is practically identical. It is governed by convocation and bishops consecrated, in the line of the Canterbury succession, by the Right Rev. Bishop Cummins, who founded the Reformed Episcopal Church of America in 1873, when he resigned his connection with the Protestant Episcopal Church, while claiming, on its own grounds, the indelibility of his orders. See REFORMED EPISCOPAL CHURCH, in these Supplements.

**FREE CONGREGATIONS.** See GUSTAVUS ADOLPHUS UNION, Vol. XI, p. 335.

**FREEDMAN.** See SLAVERY, Vol. XXII, p. 133.

**FREEDMEN'S BUREAU**, a bureau of the War Department in the United States, established by act of March 3, 1865, to look after the needs growing out of the abolition of slavery. To meet the grave questions raised by this state of things, the act gave the bureau the management of confiscated or of abandoned lands, and of all matters relating to freedmen and refugees in any district under the jurisdiction of the army. The bureau was in charge of a commissioner, who was appointed by the President and confirmed by the Senate, Gen. O. O. Howard receiving the appointment. The powers of the bureau were afterward enlarged to embrace "the care of all refugees and freedmen so far as to enable them to become practically self-supporting United States citizens." The Freedmen's Bureau was but a temporary expedient, closing in 1869 with its temporary need. Its educational work was continued until 1870. During its existence the expenditures of the bureau were about \$8,000,000, or including the bounty and prize-money secured for the freedmen, the total amount handled exceeded \$20,000,000.

**FREEHOLD**, a town and the capital of Monmouth County, central New Jersey, 24 miles E. of Trenton, on the Pennsylvania and Jersey Central railroads. It has machine-shops, a planing-mill, iron foundry, and an underwear factory employing four hundred persons. It has modern city conveniences, electric and gas lights, water from an artesian well, and sewers. It has a fine monument, erected in 1884 to commemorate the battle of Monmouth, July 28, 1778. Population 1890, 2,932; 1900, 5,254.

**FREE-LANCES**, roving companies of knights and men-at-arms, who, after the Crusades had ceased to give them employment, wandered from state to state, selling their services to any lord who was willing to purchase their aid in the perpetual feuds of the middle ages. They played their most prominent part in Italy, where they were known as *Condottieri*.

**FREELAND**, a village of Luzerne County, northeastern Pennsylvania, 15 miles S. of Wilkesbarre, on the Lehigh Valley railroad. The surrounding country, of which it is the shipping and business center, is devoted to agriculture and mining. Its industries are lumber-planing and machine-making. It is supplied with electricity and city water. Population 1900, 2,394.

**FREEMAN, EDWARD AUGUSTUS**, a British historian, regius professor of modern history at Oxford, was born at Harborne, Staffordshire, England, Aug. 2, 1823, and died in Alicante, Spain, March 16, 1892. He was elected scholar of Trinity College, Oxford, in 1841; fellow, in 1845; filled the office of examiner in the School of Law and Modern History in 1857-58, and again in 1863-64, and in the School of Modern History in 1873. He was created honorary D.C.L.



EDWARD A. FREEMAN.

by the University of Oxford at the installation of the Marquis of Salisbury in 1870, and honorary LL.D. by the University of Cambridge in 1874. He was the recipient, also, of many other honorary degrees from Continental universities; had conferred upon him a number of knightly orders and decorations; in 1877 had the distinction paid him of being made honorary member of the Imperial University of St. Petersburg, and was corresponding member of the Historical Society of Massachusetts. He wrote much on historical, parliamentary and architectural subjects, and contributed largely to periodicals on cognate topics. He was a Liberal in English politics, and in 1868 contested Mid-Somerset in that interest in the House of Commons, but without success. In 1884 he became regius professor of modern history at Oxford, and the recognized leader, among English historians, of what is termed the Teutonic school of English historical writers, which makes much of Teutonic influence as an element in the life and thought of the English people. He was also a stickler, to an almost pedantic extent, for the truth of history, and was unsparing in his denunciation of picturesque historical writing, such as characterized the work of James Anthony Froude, his successor in the chair of modern history at Oxford. Though himself learned and accurate as a writer, and influenced in his labors by high ideals, Freeman lacked the insight and breadth of view possessed by some historians who had not his industry and extent of knowledge. Though a voluminous writer on historical subjects, he will remain best known by his monumental work, in five volumes, which appeared during the years 1867-76, on the *History of the Norman Conquest*. Much less ambitious, though for educational purposes equally important, works are his *Old English History* (1869) and his *General Sketch of European History* (1872). Valuable, also, are his Rede lectures, delivered at Cambridge in 1872, on *The Unity of History*, his treatise on the *Growth of the English Constitution* (1872), and his *Historical Geography of Europe* (1881). The more important of his other works are four series of *Historical Essays* (1872-82); *The Reign of William Rufus and Henry I*

(1882); *Comparative Politics* (1873); *English Towns and Districts* (1883); *History of Sicily* (1891-92); *William the Conqueror*, in the Twelve English Statesmen Series; and *Sicily: Phœnician, Greek and Roman*, in the Story of the Nations Series. Besides these works, Dr. Freeman published a number of lectures on historical, antiquarian and topographical subjects, including *Lectures to American Audiences* (1883); a study of *George Washington* (1888); a quasi-political work on the Church of England, *Disestablishment and Disendowment* (1874); *Studies of Travel in Greece and Italy* (2 vols.); *Some Impressions of the United States* (1883); *Greater Greece and Greater Britain* (1888); *The Ottoman Power in Europe* (1877); and *Methods of Historical Study* (1886). His writings on architecture embrace a work on *Church Restoration* (1846); a *History of Architecture* (1849); *Window Tracery in England* (1850); *Llandaff Cathedral* (1851); and *Historical and Architectural Sketches*, chiefly Italian (1876). *The Life and Letters of Prof. E. A. Freeman*, edited by W. R. Stephens, dean of Winchester (2 vols.), appeared in 1894.

FREEMAN, JAMES, an American Unitarian clergyman; born in Charlestown, Massachusetts, April 22, 1759. He was educated in the Episcopal Church, but adopted Unitarian tenets, and was the first American minister of that persuasion, his church, called the "King's Chapel," the oldest Episcopal Church in Boston, becoming the first Unitarian Church in New England. Harvard made him D.D. in 1811. He died at Newton, Massachusetts, Nov. 14, 1835.

FREEMAN, JAMES EDWARD, an American artist; born in Nova Scotia in 1808; died in England in 1884. He became an associate of the National Academy of Design in New York in 1831 and an academician two years later. He painted principally portraits and *genre* pictures. Among his works are *The Beggars*; *The Savoyard Boy in London*; *Young Italy*; etc. He published, in London, a *Portfolio of Italian Sketches*.

FREEMAN, JAMES MIDWINTER, an American clergyman and author; born in New York City, Jan. 29, 1827; was graduated at the Wesleyan University in 1866, and became a pastor in the Methodist Episcopal Church. In 1872 he was appointed editor and secretary of the Methodist Episcopal Sunday School Union and Tract Society. Besides his books for young people, he published *Hand-Book of Bible Manners and Customs* (1874); *The Use of Illustrations in Sunday School Teaching*; *A Short History of the English Bible* (1879); *Book of Books* (1880); etc.

FREEMANTLE, a town and the chief port of Western Australia, at the mouth of Swan River, at lat. 32° 3' S. It is 10 miles S.W. of Perth, and has daily steamboat connections with it. Its harbor is as yet but an open roadstead, but improvements are projected. Population, 5,600.

FREE METHODISTS, a sect originated in 1860, at Pekin, New York, by friends of two ministers expelled at the Genesee conference. The sect disclaims episcopacy. It has, however, an elective

superintendent, who serves four years. Congregational singing, without the aid of instrumental music, is enforced. Free seats in the church are maintained; extempore preaching is the rule, and quiet apparel and plain living are cardinal virtues; while the doctrine of Christian perfection is insisted upon. The churches number over 950, and the membership, mostly in western New York, Illinois and Michigan, about 23,000. The members maintain a journal, *The Free Methodist*, published in Chicago.

FREE PORT, a port at whose wharves the vessels of all nations can load and unload free of customs duties and commercial charges, with the exception of the usual harbor dues. A free port is thus, from the commercial point of view, an open harbor, in contradistinction to one that is closed to all vessels except those of the country in which it is situated, and from the administrative point of view, financially a foreign territory within the state to which it politically belongs. In the middle ages free ports were established for the purpose of attracting trade to particular maritime centers, especially by Italy, France, Spain, Austria and Portugal, at the period when the exploitation of their colonies for the benefit of the mother-country was the ruling principle in the commercial policy of those states. At the end of the eighteenth and the beginning of the nineteenth century free ports acquired a position of peculiar importance during the years in which prohibitive and protectionist measures were in force. Since then, however, they have decreased both in importance and in number. At the present time their chief use is that of *entrepôts* for facilitating the more convenient interchange and distribution of commodities destined for more or less distant markets. To all intents and purposes, their utility has been destroyed by the rival system of bonded warehousing, which has always prevailed in England and the United States in preference to the other system. In 1889 the only free ports remaining in Europe were Trieste and Fiume in Austria, and Hamburg and Bremen in Germany; but both Trieste and Fiume were on the point of being abolished as free ports, while in Hamburg and Bremen since 1888 only a restricted area has been maintained as a free port. Among free ports outside of Europe are Hongkong, Menado in Celebes, Singapore, Georgetown (Penang), Amboyna, Banda, Ternate, St. Thomas (on the island of the same name in the West Indies), and Livingstone in Guatemala.

FREEPORT, a city of Stephenson County, northern Illinois (see FREEPORT, Vol. IX, p. 752). It has excellent railroad facilities, being at the western terminus of a division of the Chicago and North-Western railroad, at its junction with the Illinois Central, and on the Chicago, Milwaukee and St. Paul railroad, and on the Pecatonica River, which supplies water-power. Freeport College (Presbyterian), established here in 1872, is a flourishing institution. The city is largely engaged in trade and manufactures, and its growth, though not rapid, is substantial. Its manufactures include those of wheels, carriages, bicycles, wind-mills, coffee-grinders, castings and vinegar; the Illinois Central rail-

road car-shops are located here. Population 1880, 8,515; 1890, 10,189; 1900, 13,258.

**FREEPORT**, a village of Queens County, Long Island, New York, on the South Side railway, and 24 miles from Brooklyn. Oyster-planting and fishing are the chief industries. Population 1900, 2,612.

**FREEPORT**, a borough of Armstrong County, central western Pennsylvania, on the Allegheny River (navigable), and on the Pennsylvania railroad, 25 miles N.E. of Pittsburg. It has good educational advantages, an academy, manufactories, a tannery, grist-mills, saw and planing mills, three large distilleries, producing 200 barrels of whisky daily. The place is lighted with gas. Population 1900, 1,754.

**FREE SILVER**, a prominent issue of the Presidential campaign of 1896. For a discussion of the entire question, see **BULLION**, Vol. IV, pp. 518, 519; **EXCHANGE**, Vol. VIII, pp. 784-796; **MONEY**, Vol. XVI, pp. 720-738; **SILVER**, Vol. XXII, pp. 69-74; and **COINAGE LAWS, COINS AND COINAGE; CRIME OF 1873; and FINANCES OF THE UNITED STATES**, in these Supplements.

**FREE-SOIL PARTY, THE**, an American political party, whose cardinal principle was opposition to the extension of slavery in the United States. It was organized at Buffalo, New York, in 1848, and comprised the Liberty party, the Barnburners (antislavery Democrats of New York) and antislavery Whigs. Their first candidate was Martin Van Buren, but he received no electoral votes and but 291,000 popular votes. In 1852 it nominated John P. Hale, who met with no better success, and in 1856 it became part of the Republican party.

**FREE SONS OF ISRAEL, INDEPENDENT ORDER OF.** See **BENEFIT SOCIETIES**, in these Supplements.

**FREEWILL.** See **ETHICS**, Vol. VIII, p. 608; **PREDESTINATION**, Vol. XIX, p. 670.

**FREZZING.** See *Calorimetry*, under **HEAT**, Vol. XI, pp. 556, 557; **ICE**, Vol. XII, pp. 611-621; and **ICE-MACHINES and REFRIGERATING APPARATUS**, in these Supplements.

**FREGELLÆ.** See **PONTECORVO**, Vol. XIX, p. 454.

**FREI or FREY, EMIL**, a Swiss statesman and diplomat; born at Arlesheim, Oct. 23, 1838. While temporarily in the United States in 1861, he enlisted in the Union army as a sergeant, was captured at Gettysburg and suffered privations in Libby Prison. Returning home after the war, he was sent as minister of Switzerland to the United States (1882-87), and was elected President of the Swiss Republic, Dec. 14, 1893, for one year.

**FREIGHT**, literally, that which is "fraught or faded," is by custom understood to be the price paid for the use of a ship, or a portion of a ship, for the transport of goods; also the goods so transported. In the United States it is extended to refer to goods transported by land on railroads, the cars in which the goods are carried being called "freight-cars," and the price paid for transporting the same, "the freight." The phrases to "ship goods," and putting goods "on board" the freight-cars, show the derivative connection. For the law, etc., relating to freight, see **CHARTER-PARTY**, Vol. V, p. 433; **CARRIER**, Vol. V, p. 138; **BILL OF LADING**, Vol. III,

p. 674. In the United States the common-law principle has not been changed.

**FREIGHT-CARS.** See **RAILROADS**, in these Supplements.

**FREIGHT POOLS.** See **RAILROADS**, in these Supplements.

**FRÉJUS, COL DE**, the pass in the Cottian Alps, under which the Mont Cenis tunnel was cut, 14 miles from the Mont Cenis road, which reaches a height of 6,860 feet. The tunnel was excavated by France and Italy during the years 1861-70. See **TUNNELING**, Vol. XXIII, p. 624.

**FRELINGHUYSEN, FREDERICK**, an American statesman, grandson of a Dutch pastor who emigrated to New Jersey in 1720; was born in 1753, graduated at Princeton, and was admitted to the bar in 1774. He raised a corps of artillery and took part in the battles of Trenton and Monmouth Courthouse; and he was a member of the Continental Congress in 1778 and 1782-83, and a United States Senator in 1793-96. In 1794 he was made a major-general of militia. He died in 1804.

**FRELINGHUYSEN, FREDERICK THEODORE**, an American lawyer; born at Millstone, New Jersey, Aug. 4, 1817; graduated at Rutgers College in 1836; called to the bar in 1839. He practiced law and held minor offices in New Jersey, and in 1861 became attorney-general of that state. From December, 1866, to March 4, 1869, he served as United States Senator. In 1870 he was nominated and confirmed as minister to England, but declined the appointment. In July, 1871, he was again elected to the United States Senate, and served until 1877. He was a strong Republican; voted for the conviction of Andrew Johnson, supported the Civil Rights Bill and was an ardent protectionist. He was a member of the Hayes-Tilden Electoral Commission. On Dec. 12, 1881, he became Secretary of State in President Arthur's Cabinet, and held office until March 4, 1885. He died at Newark, New Jersey, May 20, 1885.

**FRELINGHUYSEN, THEODORE**, an American statesman; born at Millstone, New Jersey, March 28, 1787. He studied law and practiced in New Jersey, and from 1817 to 1829 was attorney-general of that state. In 1829 he was chosen United States Senator, and served until 1835. Afterward he was mayor of Newark, and in 1839 became chancellor of the University of New York. In May, 1834, he was nominated for Vice-President by the Whigs, Henry Clay heading the ticket. In 1850 Mr. Frelinghuyesen became president of Rutgers College, which position he held until his death. He died at New Brunswick, New Jersey, April 12, 1861.

**FRELINGHUYSEN, THEODORUS JACOBUS**, an American clergyman; born at Lingen, now in Prussia, in 1691; was ordained to the Dutch Reformed ministry, and preached two years in his native country. In 1720 he went to the United States, becoming pastor of a church at Raritan, afterward New Brunswick, New Jersey. He secured the recognition of the independence of his church in America, and was regarded as one of the greatest of American divines. He had five sons, who became ministers, and two daughters, who married ministers. He died in 1747.

FREMANTLE, WILLIAM HENRY, an English religious writer; born in 1831; the second son of the late Lord Cottesloe; educated at Balliol College, Oxford; a fellow of All Souls in 1855-63; appointed, in 1865, to the rectory of St. Mary's, Marylebone, London; select preacher at Oxford in 1878-80; Bampton lecturer at Oxford in 1882; and in the same year was appointed to the canonry residentiary in Canterbury Cathedral. He published *The Influence of Commerce upon Christianity* (1854); *The Doctrine of Reconciliation to God by Jesus Christ* (1870); *The Gospel of the Secular Life* (1882); *The World as the Subject of Redemption* (Bampton lectures, 1885); *The Present Work of the Anglican Communion* (1888); etc.

FRÉMIET, EMMANUEL, a French sculptor; born in Paris, Dec. 15, 1824; studied under his uncle, François Rude; passed many years at the medical clinic, making anatomical casts, etc., for the museum at Orfila. Exhibited his first work, *Gazelle*, a plaster study, at the Salon in 1843. His *chef d'œuvre* was *Ckien Courant Blessé*, acquired for the Luxembourg in 1850. His *Le Cheval à Montfaucon* also created a sensation, and was purchased for the state in 1853. In 1868 he produced an equestrian statue of *Napoleon I* for the city of Grenoble. The statue of *Jean d'Arc*, erected in the Place des Pyramides, Paris, was finished in 1874; *St. Grégoire de Tours* (1878); *St. Michel* (1879); *Le Grand Condé*, an equestrian statue (1881); *Charles V*, a bust in marble (1882); *St. Louis* (1887); *Velasquez*, an equestrian statue (1890); *St. Georges* (1891), etc. He succeeded Louis Barye in 1875 as master of drawing in the Museum of Natural History at Paris. He received numerous medals, and was promoted to be officer of the Legion of Honor in 1878.

FREMY, EDMOND, a French chemist; born at Versailles, Feb. 28, 1814; studied under Gay-Lussac; became professor of chemistry in the Museum of Natural History, Paris, 1850, and at the Polytechnique in 1857. He wrote *Traité de Chimie*, and *Encyclopédie Chimique* (commenced 1881). He died at Paris, Feb. 3, 1894.

FREMONT, a village of Newaygo County, central western Michigan, on the Chicago and West Michigan railroad, 25 miles N.E. of Muskegon. It contains a tannery, lumber and stave mills and a chair factory. South of this village is Fremont Lake, a pleasant summer resort. Population 1900, 1,331.

FREMONT, a city and the capital of Dodge County, central eastern Nebraska, on the Fremont, Elkhorn and Missouri Valley, the Union Pacific and the Sioux City and Pacific railroads. It is a great market for cattle, horses, hogs and sheep. It has a normal and a business college, water-works, gas and electric lights, telephone system, pork-packing houses, planing-mills and flouring-mills. Population 1890, 6,747; 1900, 7,241.

FREMONT, a city and the capital of Sandusky County, northern Ohio, situated on the Sandusky River, at the head of navigation, 30 miles E. of Toledo by rail, on the Lake Shore and Michigan Southern, the Lake Erie and Western and other railroads. It has normal and business schools and street-railways, gas and electric lights, and city water. Steamers ply between the city and the prin-

cipal ports of Lake Erie, and it has manufactories of woolens, butter and cheese, spikes, shears, boilers, barrels, sashes and blinds; has flour-mills and engineering-works. Pop. 1890, 7,141; 1900, 8,439.

FRÉMONT, JOHN CHARLES, an American pioneer, soldier and politician; born at Savannah, Georgia, Jan. 21, 1813. He was of French descent. In 1830 he graduated at Charleston College, and in 1833 received the appointment of teacher of mathematics on the sloop-of-war *Natchez*; two years later he was made professor of mathematics in the United States navy. In 1839 he was commissioned lieutenant in the corps of topographical engineers, and



JOHN C. FRÉMONT.

in 1842 conducted a geographical survey of the then almost unknown region between the Missouri River and the Pacific Ocean. In May, 1843, he set out on a still longer expedition from the Rocky Mountains to the Pacific Coast. On his return in 1844, he was brevetted captain, and in the spring of 1845 was sent to explore the Great Western Basin and the maritime region along the Pacific, an expedition that resulted in the acquisition of California to the United States. These achievements brought him general notoriety, and he became popularly known as the "Pathfinder." During his absence from the Pacific Coast, war was declared between the United States and Mexico, and General Kearney was sent to take possession of California. Frémont refused to obey some orders of the general, who was his military superior, was placed under arrest and ordered to report at Washington. He was tried by court-martial, found guilty, and ordered to be dismissed from the service. President Polk sustained a part of the sentence, but remitted the penalty, and Frémont resigned his commission. In October, 1848, he fitted out, at his own expense, a large expedition, with the object of finding a practicable route over the mountains to California. After many hardships, he and his party reached Sacramento in the spring of 1849. Here he bought a large estate containing rich gold-mines. In 1850-51 he was United States Senator from California. In 1853 he led a fifth expedition along the line of the fourth, and in 1855 he settled in New York City. In 1856 he was the first candidate of the Republican party for President of the United States and was defeated. When the Civil War began, Frémont was made major-general, in command of the Western Department, his headquarters being at St. Louis. Here, without authority, he issued a proclamation freeing the slaves in his district, which was not confirmed by the government. Frémont was recalled from the West thereafter and placed in command in western Virginia. Here he was outgeneraled by the Confederate commander "Stonewall" Jackson. When General Pope was placed in command of all the forces in western Virginia, Frémont resigned his commission and took no further active part in the

war. In 1864 the Cleveland convention nominated him for the Presidency, but he withdrew his name. Subsequently he devoted himself mainly to the promotion of a Southern railroad across the continent, and spent much time in Europe for this purpose. In connection with this enterprise he was charged with irregularities in France, was tried while absent, found guilty and sentenced to fine and imprisonment, but, as he was absent, the penalty could not be enforced. From 1878 to 1881 Frémont was governor of Arizona territory, and later he practiced law in New York City. On Oct. 19, 1841, Frémont was secretly married to Jessie, daughter of Senator Thomas H. Benton of Missouri. In May, 1890, Congress placed him on the retired list of the army, with the rank of major-general, and on July 13, 1890, he died. His publications include a *Report of the Exploring Expedition to the Rocky Mountains in 1842, and to Oregon and North California in 1843-44* (1845); *Col. J. C. Frémont's Explorations*, an account of all five of his expeditions (2 vols., 1859); and *Memoirs of My Life* (1886).

FRENCH, ALICE, an American writer, better known as "Octave Thanet"; born at Andover, Massachusetts, about 1860. She attracted much attention by her realistic magazine stories, which were collected in *Knitters of the Sun* (1884). Her other works include *Expiation* (1890); *Otto the Knight, and Other Stories* (1890); *We All* (1891); *Stories of a Western Town* (1893); *An Adventure in Photography* (1893); and *The Heart of Toil* (1898).

FRENCH, BENJAMIN FRANKLIN, an American historian; born in Richmond, Virginia, June 8, 1799. He contributed largely to magazines, and published *Biographia Americana* (1825); *Memoirs of Eminent Female Writers* (1827); *Historical Annals of North America* (1861); and other works. He died in New York City, May 30, 1877.

FRENCH, DANIEL CHESTER, an American sculptor; born at Exeter, N. H., April 20, 1850; studied in Italy; passed a few years in Washington, and then settled in Florence, where he produced *The Minute-Man of Concord*, an heroic statue in bronze, which was unveiled at Concord, Mass., in 1875. Others of his works are *Peace and War*, a colossal group now in the custom house at St. Louis, Mo.; similar groups for the City Hall in Philadelphia and the post office in Boston; *Elsie Venner*; *The May Queen*; a life-size statue of Governor Chase of Michigan, for the National Memorial Gallery at Washington; *Death and the Sculptor*; the colossal *Statue of the Republic* at Chicago in 1893; and *Erin and Her Children*, a bronze group for the J. B. O'Reilly monument in Boston.

FRENCH, MAJOR-GENERAL J. D. P., one of the most alert and vigorous fighting generals the English had in the war with the Boers in South Africa, was born in 1852 and in 1874 entered the

army as an Hussar officer. In 1883 he was made major, and in the following year served in the Nile Expedition, and accompanied Sir H. Stewart's column in the attempt to rescue General Charles G. ("Chinese") Gordon at Khartum. In 1889 he reached the rank of Colonel. Ten years later he obtained the command of the cavalry division in the war against the South African republics, with the rank of Lieut.-General. He won the victory of Elandslaagte in Natal, and in 1900 was made Major-General in recognition of his services in relieving Kimberley. He afterwards did some admirable work in the war: with his cavalry division he helped to enclose General Cronje and compel his surrender; he also took an active part in the operations around Bloemfontein and Wepener, and later on in pursuing fleeing columns of Boers in the Orange State and in the Transvaal.

FRENCH, WILLIAM HENRY, an American soldier; born in Baltimore, Maryland, Jan. 13, 1815; graduated at West Point in 1837; entered the artillery, and served in the Seminole and Mexican wars. In 1861 he was appointed brigadier-general of volunteers, and served in the army of the Potomac during the peninsular campaign. He commanded a division at Antietam and Fredericksburg, and in October, 1862, became major-general of volunteers. He served in the campaign of the Rappahannock, and commanded the Third Army Corps at Mine Run. In May, 1864, he was mustered out of the volunteer service, and from 1865 until 1880 served in the United States artillery. He was retired under the rule, when lieutenant-colonel, in 1880. He died in Baltimore, May 20, 1881.

FRENCH AND INDIAN WAR. See UNITED STATES, Vol. XXIII, pp. 733, 734.

FRENCH BERRIES, a name given to berries of *Rhamnus*, or "buckthorn," which are dried and shipped from the Mediterranean region for the yellow dye which they yield.

FRENCH BROAD RIVER, rises in Transylvania County, western North Carolina, near the Blue Ridge, flows northward into Tennessee, thence northwest, then west, joining the Holston River to form the Tennessee three miles above Knoxville.

FRENCH CONGO, extending along the south Atlantic coast from about lat. 5° S. to 2° N. See AFRICA, in these Supplements.

FRENCH GUINEA. See AFRICA, in these Supplements.

FRENCH HORN, a keyed brass musical instrument of the trumpet class. It has a slender twisted tube which expands into a bell-shaped opening. It is provided with mouthpieces of various lengths, for the purpose of securing variation of key, and is also provided with valves and keys. It has a compass of about four octaves, and was originally used as a hunting-horn, but it has long been successfully used as an orchestral instrument.

FRENCH INDIA. The French possessions in India, as established by the treaties of 1814 and 1815, consist of five separate towns, which cover an aggregate of 50,803 hectares (about 200 square miles), and were on Dec. 31, 1895, accredited with the following populations:



DANIEL C. FRENCH.

Pondichery .....	49,052
Karikal.....	10,172
Oulgaret.....	57,724
Villénour.....	40,032
Néoumkadou .....	24,250
Shandernagar .....	24,050
Bahour.....	31,818
La Grande Aldée.....	10,048
Mahé.....	8,011
Yanaon.....	5,011
Total.....	280,883

Of this total, less than one thousand are Europeans. The colonies are divided into five dépendances and ten communes, having municipal institutions. The governor of the colony resides at Pondichery. The colony is represented by one Senator and one Deputy. Local expenditure (1897), \$403,292; expenditure of France (budget, 1899), \$59,324. The chief exports from Pondichery are oil-seeds. The imports in 1898 were \$923,200, and the exports \$3,387,400.

**FRENCH INDO-CHINA.** Under this designation the French dependencies of Cochin China, Tonkin, Anam, and Cambodia have, to a certain extent, been incorporated. There is a superior council of Indo-China, which fixes the budget of Cochin China, and advises as to the budgets of Anam, Tonkin, and Cambodia. In 1887 the French possessions in Indo-China, including Anam and Cambodia, were united into a customs union. In 1893-96 nearly 110,000 square miles of Siam, to the east of the Mekong, were annexed by France, so that the French territory extends from the Mekong river to the Chinese border. The total area is about 284,950 square miles, and the population about 21,500,000. In 1894 there were 64 miles of railway completed. By treaty with China in 1895, the right was secured to extend this railroad into China. The country is ruled by a governor-general appointed by France. The seat of the government is at Hanoi, in Tonkin; population 80,000.

**FRENCH LICK**, a township of Orange County, central southern Indiana, on the Louisville, New Albany and Chicago railroad. Twelve saline sulphur springs are situated in a pleasant valley of this township, and the waters are useful for the cure of some diseases.

**FRENCHMAN'S BAY**, an arm of the ocean extending thirty miles into Hancock County, southeastern Maine, with a width of about ten miles. Mount Desert Island shelters the bay on the southwest side.

**FRENCH PROPHETS.** See CAMISARDS, Vol. IV, pp. 743-745.

**FRENCH PURPLE.** See ARCHIL, Vol. II, p. 379.

**FRENCH RIVER**, a stream with several channels, from one to four miles wide, which forms the outlet of Lake Nipissing, northern Ontario, Canada. Its length is about eighty miles; direction, west-southwest. It empties into Georgian Bay. It is very swift and has many rapids, but it is the channel of a considerable fur trade.

**FRENCH SOUDAN.** See AFRICA, in these Supplements.

**FRENCH SPOILIATION CLAIMS.** Claims arising out of damages inflicted by French privateers upon the ships and cargoes of United States citizens, between 1790 and 1800, while the French were at war with England. The United States remained neutral, while France claimed that under the treaty of 1778 (Jay's treaty) they were bound to assist France. Failing to do so, France retaliated by seizing and converting to her own uses some twelve hundred American vessels sailing on the high seas. The American losses were estimated at some twenty million dollars. France claimed damages many times as great because of failure by the United States to fulfill treaty obligations. In 1801 a convention of representatives from both countries agreed to a mutual surrender of claims, those of the United States being fixed at about five million dollars. The agreement was ratified and the United States government thus assumed the spoliation claims. The responsibility for indemnifying the claimants was virtually denied by the government until in 1848 Congress finally passed a bill authorizing payment of the claims. It was vetoed by President Polk. A similar bill was later vetoed by President Pierce. January, 1885, Congress passed a bill, signed by President Cleveland, providing for the presentation of the claims to the court of claims for adjudication as to their validity, and in 1891 Congress began to make appropriations for the payment of the claims as they were adjudicated.

**FRENCHTOWN**, a manufacturing borough of Hunterdon County, northwestern New Jersey, on the Delaware River, and on the Pennsylvania railroad, 27 miles N.W. of Trenton. Among the articles made here are iron and brass castings, regalia, sashes and blinds, distilled liquors and carriages. Population 1900, 1,020.

**FRENCH WEST AFRICA.** See AFRICA, in these Supplements.

**FRENEAU**, PHILIP, an American poet; born in New York City, Jan. 21, 1752. He was of French descent, and was graduated at Princeton in 1771. In 1776 he visited the West Indies, and in 1778 went to the Bermuda Islands. In 1780, during the war of the Revolution, he again sailed for the West Indies, when he was captured by a British cruiser. After the return of peace, Freneau became, in succession, editor of a newspaper and captain of a ship that plied between New York, the West Indies and the Southern states. He contributed to the *United States Magazine* and the *Freeman's Journal*, and in 1790 became editor of the *New York Daily Advertiser*. Later he was appointed translator for the State Department, and at the same time assumed the editorship of the *National Gazette*. He next became editor of the *Jersey Chronicle*, and in 1797 of the *New York Time-piece and Literary Companion*; but his connection with this paper was brief. Freneau published *A Poem on the Rising Glory of America* (1771); *Voyage to Boston* (1774); *General Gage's Confession* (1775); *The British Prison-Ship* (1781); *The Poems of Philip Freneau, Written Chiefly During the Late War* (1786); *A Journey from Philadelphia to New York, by Robert Slender, Stocking-Weaver* (1787); *The Miscellaneous Works of Mr. Philip Freneau*

(1788); *The Village Merchant* (1794); *Poems Written between the Years 1668 and 1794* (1795); *Letters on Various Interesting and Important Subjects, by Robert Slender* (1799); *Poems Written and Published During the American Revolutionary War* (1809); *A Collection of Poems on American Affairs* (1815); and a translation of Abbé Robin's *Voyages and Travels* (1783). He died near Freehold, New Jersey, Dec. 18, 1832.

FRENTANI. See SAMNITES, Vol. XXI, pp. 128, 248.

FREPPEL, CHARLES EMILE, a French theologian; born in France, June 1, 1827; entered the priesthood, and in 1870 became bishop of Angers. He was returned to the Chamber of Deputies as a Legitimist in 1881 and re-elected in 1885. He wrote a criticism on Renan's *Vie de Jesus*, and many histories of the saints and fathers of the church. He died in Paris, Dec. 22, 1891.

FRÈRE, CHARLES THÉODORE, a French painter; born in Paris, June 24, 1815; died in 1888. He studied art with Coignet and Roqueplan, and made his first public appearance at the exhibition of 1834. In 1836 he went to Algeria, was present at the taking of the city of Constantine by the French in October, 1837, and afterward visited the East. His pictures are chiefly representations of Oriental scenes. Among the more famous of these are the *Hall of the Arabs*, which was bought by the French government in 1850; *A Harem at Cairo*; *Ruins of Karnak*; *The Island of Philæ*; *The Caravan of Mecca*; *The Nile—Evening*; and *The Desert—Noon*.

FRÈRE, SIR HENRY BARTLE EDWARD, an English colonial officer; born in Wales, March 29, 1815. He was educated at Bath and at Haileybury College, and entered the Indian civil service in 1833. In 1847 he became British resident at Sattara, and three years later chief commissioner of Sind. During the Mutiny in 1857 he succeeded in keeping his own province in subjection and assisted his colleagues in adjoining provinces. In 1862 he was appointed governor of Bombay, which post he held until his return to England in 1867. In 1872 he was employed on a successful mission to Zanzibar for the suppression of the slave trade, and in 1877 was appointed governor of the Cape, and high commissioner for the settlement of affairs in South Africa. There being considerable difference of opinion among English statesmen with regard to the ratification of Sir Bartle's course in the Zulu war, he was recalled by the government in 1880. He subsequently devoted himself to the duties entailed upon him by the presidency of various learned societies, and to the promotion of missionary work. He published several works on Indian and African subjects. He died at Wimbledon, May 29, 1884. A statue was erected to his memory on the Thames Embankment, London.

FRÈRE, PIERRE ÉDOUARD, a French painter, "the laureate of the poor"; born in Paris, Jan. 10, 1819; died at Ecouen, May 23, 1886; studied under Delaroche, and first exhibited in the Salon of 1843. Most of his pictures represent the amusements and occupations of country children, and they are characterized by much grace and purity of feeling. His best-known works are *The Little Gourmand*;

*Boys Going from School*; *Girls Going from School*, *The Road to School*; *The Orphan's First Prayer*; and *Preparing for Church*. The last is in the Corcoran Gallery at Washington.

FRÈRE-ORBAN, HUBERT JOSEPH WALTHER, a Belgian statesman; born at Liège, April 24, 1812; was called to the bar of his native city, and acquired a high reputation among the Liberal party. Liège returned him to the Belgian Chamber as its Representative in 1847. He was Minister of Public Works and then Minister of Finance in that year; and began the reform of the corn laws in Belgium, before Sir Robert Peel reformed the corn laws in England. Frère-Orban was a Cabinet minister (with but short intervals) for nearly half a century; he was the founder of the Banque Nationale and of the Caisse d'Épargne, and during his various administrations much was done to advance the country; octrois were abolished; education extended; the salt tax repealed; the great camp on the Escaut, which insures a free landing to Belgium's ally, was established; and many laws passed for the regulation of labor, and for promoting the welfare of both capitalists and workmen. The Emperor of Austria conferred on him, in May, 1881, the grand cross of the Order of St. Stephen. Died in Brussels, Jan. 2, 1896.

FRESENIUS, KARL REMIGIUS, a German chemist; born at Frankfort-on-the-Main, Dec. 28, 1818; after studying at Bonn and Giessen he became assistant to Liebig; was appointed professor of chemistry at Wiesbaden in 1845, where he established a laboratory in 1848. He founded the *Zeitschrift für Analytische Chemie* in 1862, and wrote *Anleitung zur Qualitativen Analyse* (1841); *Anleitung zur Quantitativen Analyse* (1846); *Geschichte der Chemie* (1873). Died at Wiesbaden, June 11, 1897.

FRESNILLO, a mining town of Zacatecas state, central Mexico, which lies 7,200 feet above sea-level, at the foot of the argentiferous Cerro de Proaño, on the Mexican railroad, 35 miles N. of Zacatecas City. It has amalgamation-works and silver and copper mines. Population, 15,000.

FRESNO, an enterprising city of central California, the capital of Fresno County, about 20 miles E. of the San Joaquin River and 40 miles N. of Tulare Lake, on the Southern Pacific railroad. The region around is devoted to sheep-raising, wheat, fruit-growing and wine and raisin making. The city has a street-railway, gas and electric lights, city water and a sewer system. The city is abundantly supplied with electricity for lighting and motive purposes through water-motors, which receive their power from the falls of the San Joaquin River, 30 miles away. Population 1890, 10,818; 1900, 12,470.

FREUND, HERMANN ERNST, a Danish sculptor; born near Bremen, Oct. 15, 1786; studied at the Art Academy, Copenhagen, winning the gold prize medal, which gave him the opportunity of going abroad for further study. At Rome he met and received encouragement from Thorwaldsen and produced his *St. Luke* and *Mercury*. On the revival of the interest in Scandinavian literature after his return home, he directed his attention patriotically to the production of works representing the rich mythology of his native country. Among his more

noted works in this department was his Ragnarock frieze, executed for the Christiansborg palace. He died June 30, 1840.

FREUND, WILHELM, a German philologist; born, of Jewish parents, Jan. 27, 1806, at Kempen, in Posen. Having studied at Berlin and Breslau (1824-28), he taught at Breslau, Hirschberg, in 1848-51, and at Gleiwitz in 1855-70, and finally settled down at Breslau to a life of literary activity. His principal work is a *Wörterbuch der Lateinischen Sprache* (4 vols., 1834-45), on which the best-known Latin-English dictionaries are based. Besides this he wrote a number of school books, especially on the Greek and Roman classics, and some on philology.

FREY. See ÆSIR, Vol. I, p. 210.

FREY, EMIL. See FREI, EMILE, in these Supplements.

FREYCINET, CHARLES LOUIS DE SAULCES DE, a French statesman; born at Foix, Nov. 14, 1828, and educated at the École Polytechnique, in Paris. Appointed in 1864 an ordinary engineer of the first class, he was until 1870 a member of the council of Tarn-et-Garonne. In October, 1870, Gambetta appointed him his subordinate in the War Department. Elected to the Senate in 1876, he became Minister of Public Works in 1877, and Premier in 1879, with the

portfolio of Foreign Affairs. He resigned in 1880, but formed a ministry again in 1882 and in 1886, and in 1889 he became Minister of War under Tirard. In 1890 he became, for the fourth time, Premier and Minister of War. On Feb. 19, 1892, the Freycinet ministry resigned. This ministry is noted as the longest in power since the formation of the present republic. Its government was wise and strong. It crushed the Boulangist conspiracy, held in check anarchy and socialism, and won a respect for republicanism before unknown in France. Under Freycinet the French army grew, until today it is the most complete organization for war ever known. Freycinet published several works on engineering, sanitation, etc., of acknowledged excellence. In 1878 he was elected a member of the Academy of Sciences, in 1891 of the French Academy, and an officer of the Legion of Honor.

FREYTAG, GUSTAV, a German writer; born July 13, 1816, at Kreuzburg, in Silesia; studied at Breslau and Berlin, and from 1839 till 1847 was a lecturer on German language and literature in the former university. In 1848 he settled at Leipsic, where he edited the *Grenzboten* until 1870. In 1879 he made his home at Wiesbaden. His dramas, *Die Valentine* (1847), *Graf Waldemar* (1850), and *Die Journalisten* (1853), proved brilliant successes; but his greatest achievement in literature is undoubtedly *Soll und Haben* (1855; 30th ed. 1885), a realistic novel of German commercial life, which was trans-

lated into English under the title of *Debit and Credit* (1858). Others of his works are *Die Verlorene Handschrift* (1864; Eng., *The Lost Manuscript*, 1865); and the series (1872-81) called *Die Ahnen* (*Our Ancestors*), a series of stories illustrating German history from the earliest times; *Die Technik des Dramas*; the *Life of Karl Mathy*; *Doctor Luther* (1883). Some of these works have been translated into English by Mrs. Malcolm. Died at Wiesbaden, April 30, 1895.

FRIAR-BIRD. See HONEY-EATER, Vol. XII, p. 139.

FRIDAY, the sixth day in the week. In Roman, Eastern and Anglican churches all Fridays, except when that day happens to be Christmas day, are observed as fast-days, in memory of the crucifixion, though this event is more appropriately commemorated on Good Friday, the Friday before Easter. Among Mohammedans, Friday is the day of assembly, or Sabbath. It is believed by them to have been instituted by divine command, as being the day upon which Adam was created and received into Paradise, the day on which he was expelled therefrom, the day upon which he is said to have repented, and the day upon which he died. According to the same belief, it will also be the day of resurrection. Black Friday is so known in the Western Church, because on that day the vestments of the clergy, as well as the covering of the altar, are black. Any Friday is also so called that has been marked by a great calamity, as Friday, Sept. 24, 1869, in New York City, when a sudden financial panic overwhelmed the country. A similar panic occurred on Friday, Sept. 18, 1873, in New York City. It used to be the common day on which criminals were hanged. Hence the phrase, "hangmen's day," refers still to Friday. Much superstition surrounds Friday, in the minds of those who are inclined to pay heed to such things. It was considered a bad day to commence any undertaking; sailors would not go to sea on Friday; and to spill salt on Friday was a particularly bad omen. Golden Friday, or Holy Friday, is a Friday in an Ember week. See ASTROLOGY, Vol. II, p. 741; CALENDAR, Vol. IV, p. 665; and SABBATH, Vol. XXI, p. 125.

FRIEDLAND, VALENTIN. See TROTZENDORFF, Vol. XXIII, pp. 588, 589.

FRIEDLÄNDER, LUDWIG, a German archæologist and philologist; born at Königsberg, July 24, 1824; educated at the universities of Königsberg, Leipsic and Berlin; made a tour of scientific investigation in Italy (1853-54); became professor of classics and archæology at the University of Königsberg in 1859. He made important contributions to Homeric literature and classical archæology. His best-known work is *Darstellung aus der Sittengeschichte Roms*. (3 vols., 1865-70). He is recognized as an authority on the description of the ruins of ancient Rome.

FRIEDRICH, JOHANN, a German Roman Catholic theologian; born in Franconia in 1836. He was a leader with Döllinger in the Old Catholic movement. He became a professor of theology at Munich in 1865; assisted at the Vatican Council in 1870, and subsequently, in life and labors, was identified with the Old Catholics.



M. DE FREYCINET.



FRIEDRICHRODA, a town of Thüringen, central eastern Germany, a popular and favorite summer resort in the beautiful Schilfwasser valley, just below the Thüringerwald, 13 miles S.W. of Gotha by rail. The Duke of Gotha's handsome country seat, Reinhardsbrunn, is situated here, on the site of the old abbey of that name, which was destroyed in the Peasant War. The town has bleaching establishments and large laundries, supplied from Magdeburg, Berlin and Hamburg. Population, 3,146.

FRIEND, a village of Saline County, southeastern Nebraska, on the Burlington and Missouri River railroad, 28 miles W.S.W. of Lincoln. It is situated in a very rich farming section, and has large grain-elevators, and a creamery which has a reputation for the fine quality of its products. Population 1890, 1,347; 1900, 1,200.

FRIENDLY SOCIETIES. See Vol. IX, pp. 780-785; and BENEFIT SOCIETIES, MUTUAL, in these Supplements.

FRIENDS, SOCIETY OF, IN THE UNITED STATES. For general article describing the origin, history, doctrine, etc., see QUAKERS, Vol. XX, pp. 147-153. An ecclesiastical association, the affairs of the Society are conducted in preparative, monthly, quarterly and yearly meetings, corresponding, in some measure, to the classis, synod, etc., of other religious bodies. Every congregation has its "elders" and "overseers," the former watching over the spiritual welfare and the latter attending to matters of discipline, or the rules that have been adopted, from time to time, as occasion demanded. The overseers also act as arbitrators to adjust grievances and prepare business to be transacted at the monthly meeting, which is composed of representatives from a number of convenient preparative meetings. To the monthly meeting is delegated executive power; e.g., power to approve and acknowledge ministers and teachers, to control membership, regulate marriage; manage the finances, etc. From their decisions appeal lies to the quarterly meeting, composed of delegates from two or more monthly meetings. The quarterly meeting is an advisory body, and prepares questions of appeal for the yearly meeting, which is composed of delegates from the quarterly meetings, and is the final authority in all matters pertaining to the organization. The yearly meeting usually covers a state or other convenient district. There were, in 1894, fourteen yearly meetings in the Orthodox branch and seven in the Hicksite. There is no union of the various yearly meetings into one general executive head.

During the Revolutionary War the first division of the Society in America occurred over the contention as to aiding or not aiding in the struggle for independence. The majority, true to the doctrines and rules of the body, refused to take any part in warfare, but a minority of about one thousand withdrew from the Philadelphia meeting, became known as "Free Quakers," and maintained their organization for many years, a remnant being still represented in the Philadelphia Apprentices' Library. The division into Orthodox and Hicksite (see Vol. XX, p. 149) is still maintained, the former number-

ing (in 1895) 88,158 members, scattered as follows:

YEARLY MEETINGS.	MEMBERS.	YEARLY MEETINGS.	MEMBERS.
New England. ....	4,389	Iowa. ....	10,642
Philadelphia. ....	4,513	Western (Indiana). .	15,195
New York. ....	3,808	Indiana. ....	18,182
Oregon. ....	1,777	Kansas. ....	10,583
Canada. ....	1,064	Baltimore. ....	1,122
North Carolina. ....	4,998	California. ....	1,202
Wilmington (Ohio). .	5,099	Mexico. ....	500
Ohio. ....	5,084		

The Hicksites numbered, in 1890, 21,992 members in 213 churches. Both of these have relaxed more or less from the ancient rigid discipline, and modified the old doctrine. When, in 1837, Joseph J. Gurney came to New England, his preaching was considered by the ultra-orthodox minority as unsound, and was especially condemned as "too evangelical" by one John Wilbur of Rhode Island, who was consequently "disowned" by the Greenwich yearly meeting in 1843. A considerable number of Friends followed Wilbur, and these have since been known as Wilburites, but called themselves Primitive Friends, indicating their adherence to the primitive customs of the Society. In 1890 these numbered 4,329 members, in 52 organizations.

Progressive Friends, a small, independent body in Chester County, Pennsylvania, require no religious test for membership, have a paid ministry and are especially devoted to social reforms. The strife between the adherents to old customs and the friends of progress and change, which caused the divisions of the past, still manifests itself, and causes, sometimes temporary, sometimes what bids fair to be permanent, disruptions. A recent innovation, that of a supported ministry, has been adopted by ten yearly meetings of the Orthodox branch. In some instances men and women meet in single assembly, each having equal voice in all the affairs of the meeting. In the Iowa yearly meeting of 1894, for the first time, representatives of both sexes met in one meeting, with a single presiding officer, having assistants of both sexes. The conservative element, however, vigorously opposes these changes, and further division is likely to result. The principal educational institutions of the society are Haverford College, for men only (Orthodox), near Philadelphia, founded in 1832, and having, in 1895, 17 instructors, 98 students and a library of 31,600 volumes; and Swarthmore College, the chief representative of the liberal or Hicksite branch, is ten miles south of Philadelphia, is co-educational, was established in 1870, and had, in 1895, 20 instructors, 176 students and a library of 16,500 volumes. Bryn Mawr College, for women, was founded by an Orthodox Friend, and its trustees are members of that body. There are also colleges at Richmond, Indiana; Oskaloosa, Iowa; Wilmington, Ohio; and Newberg, Oregon. Denominational schools of lower grade are abundant. Foreign missionary work is carried on in India, China, Japan, Syria, Madagascar and Jamaica. Among the periodicals published by the Society are *The Friend*; *The Christian*

*Worker; The Friends Review* (Orthodox); and *The Friends' Intelligencer* (Hicksite).

See Sewell's *History of the Quakers*; Janney's *History of Friends*; F. Storrs Turner's *The Quakers*.

FRIENDSHIP, a village of Allegany County, southwestern New York, at the junction of the New York, Lake Erie and Western and the Central New York and Western railroads. It is the seat of Baxter's Musical University, and has an academy, a sash and blind factory, and a cheese-box factory. Chief business, farming and cheese-making. Population 1890, 1,369; 1900, 1,214.

FRIENDS OF GOD. See MYSTICISM, Vol. XVII, p. 133.

FRIEZE. See ARCHITECTURE, Vol. II, p. 464.

FRIEZE, HENRY SIMMONS, an American educator; born in Boston, Sept. 15, 1817; died in Detroit, Michigan, Dec. 7, 1889. He graduated from Brown University in 1841, and became professor of the Latin language and literature in the University of Michigan in 1854, which position he held at the time of his death. He also twice acted as temporary president. Dr. Frieze collected in Europe the casts and the engravings that formed the nucleus of the present museum of art, and in many other ways was instrumental in the development of the university.

FRIGG. See ÆSIR, Vol. I, pp. 209-211.

FRINGE TREE, the common name of *Chionanthus*, a genus of plants of the family *Oleaceæ*, consisting of small trees or large shrubs, natives of America, the West Indies and New Holland. The popular fringe tree, or snow-flower, found in the United States sometimes attains the height of thirty and forty feet, has opposite, oval leaves six or seven inches long, and numerous snow-white flowers in paniced racemes. The limb of the corolla is divided into four long linear segments; the fruit is an oval drupe. The tree is frequently cultivated as an ornamental plant.

FRINGILLIDÆ. See FINCH, Vol. IX, pp. 191-193.

FRISCHES HAFF ("Fresh-water Bay"), a lagoon on the coast of Prussia, southeast of the Gulf of Danzig, about 50 miles in length, 4 to 11 miles broad and 332 square miles in area. It was once entirely walled off from the Baltic by a narrow spit of land, through which a passage 1,247 feet wide and 14½ feet deep was cut in 1510, during a violent storm. The Haff is 10 to 16 feet deep.

FRISIAN LANGUAGE AND LITERATURE. See FRISIANS, Vol. IX, pp. 788, 789.

FRITH, WILLIAM POWELL, an English artist; born in 1819, at Studley, near Ripon. At the age of twenty he exhibited his first picture at the British Institution, a portrait of one of the children of his preceptor. In 1845 he became A.R.A., and in 1852 was made an Academician. His two great pictures, *The Derby Day* and *The Railway Station*, have been engraved many times, and some of his productions, such as *Coming of Age; English Merry-making; The Village Pastor; and Life at the Seaside*, are almost equally well known. In 1866 he exhibited *Before Dinner at Boswell's Lodgings in Bond Street*, which work was sold in 1875 for £4,567, up to that date

the highest price ever given at auction for any picture during the artist's lifetime. From that time Mr. Frith constantly exhibited both illustrations of literature and pictures after the manner of his old successes. Of these, *The Private View of the Royal Academy* (1881) was the most ambitious. His Hogarthian series, *The Road to Ruin* (1878), is also well known. Mr. Frith published his *Autobiography* in 1887, and *Further Reminiscences* in 1888. He was made a member of the academies of Vienna, Belgium and Sweden. By his own desire, he was placed on the list of retired Royal Academicians, in 1890.

FRITILLARY, a corruption of *Fritillaria*, a genus of plants of the "lily family," commonly cultivated for their showy flowers.

FRITSCHÉ, FRANZ VOLKMAR, a German philologist and scholar; born at Steinbach, Saxony, Jan. 26, 1806. He was the son of Christian Friedrich Fritsche, the theologian; studied at the University of Leipsic, and became professor of poetry and eloquence at Rostock in 1828. He published studies on the dialogues of Lucian, the monodies of Euripides, and was the author of *Questiones Aristophanes* (1835); *De Dactylisibus atque de Babyloniis* (1831); etc. He died at Rostock, March 17, 1887.

FROBISHER BAY, an inlet opening westward, near the mouth of Davis Strait, into the territory called by Frobisher Meta Incognita, at the southern end of Baffin Land. It is about two hundred miles long by above twenty wide, with rugged mountainous shores. It was, till Hall's voyage, called Frobisher Strait, being erroneously regarded as a passage into Hudson Bay.

FROEBEL, JULIUS, a German politician and author, nephew of Friedrich Froebel who founded the kindergarten system, was born at Griesheim, Germany, July 16, 1805, and studied in the universities of Munich, Jena and Berlin. He was professor of mineralogy at Zurich from 1833 to 1844; afterward edited a radical political paper; removed to Prussia, but was obliged to leave, for political reasons; took part in the revolution of 1848, and was elected to the German Congress at Frankfurt; was arrested and condemned to death for an attempt to excite a revolution in Vienna, but was pardoned. He subsequently traveled for several years in Central America, Mexico and California, returning to Germany as a naturalized American citizen. In 1862 he was an editor in Vienna; in 1867 founded the *Süddeutsche Presse* in Munich, which he edited until 1873, when he was made consul of the German Empire at Smyrna, and in 1876 was transferred to Algiers in the same capacity. Among his publications are *System der Sozialen Politik* (1847); *Aus America* (1857); *Theorie der Politik* (1861-64); *Die Gesichtspunkte und Aufgaben der Politik* (1878); *Die Realistische Weltansicht und die Utilitarische Civilisation* (1881); *Ein Lebenslauf* (1890). He died at Zurich, Nov. 7, 1893.

FROG, RAILROAD, a section of a rail, or of several rails combined, placed at a point where it is necessary for two lines to cross, or at the point of a switch from the main track to a siding or to another line. There are various kinds of frogs. In the *plate*

*frog*, the rails are riveted to a plate placed underneath; in the *bolted frog*, the rails are connected by bolts passing through the webs, cast iron filling up the space between; in the *keyed frog*, the rails are kept together with clamps capable of being tightened by wedges. The frog may have a spring attachment, by means of which the jar of the train as it passes over it is reduced. *Crossing-frogs* are those used where the tracks cross each other; when the angle is great there is an inner rail to serve as a guard. The name of this device is taken from its resemblance to the frog of a horse's hoof.

**FROGMORE**, an English royal palace and mausoleum in the park of Windsor, Berkshire. The palace, purchased by Queen Charlotte in 1800, has been one of the dwelling-houses of the Prince of Wales since 1861. The mausoleum, a Romanesque edifice, cruciform in shape and surmounted by an octagonal dome, is consecrated to the memory of the Prince Consort, whose remains were transferred to it on Dec. 18, 1862.

**FROG-SPAWN**, a name sometimes applied to certain algæ which occur in slimy masses.

**FROG-SPITTLE**, a name popularly applied to a frothy substance often seen on the leaves and stems of plants. It is sap which has been caused to exude by larvæ of various hemipterous insects. Close examination reveals these larvæ in the mass of sap.

**FROHSDORF**, a village in Lower Austria, 30 miles S. of Vienna, on the river Leitha, and near the frontiers of Hungary. It is celebrated for its splendid castle, which acquired a kind of political importance through its having been, from 1844 to 1883, the rendezvous of the elder Bourbon party and the residence of the Comte de Chambord.

**FROLICH, LORENTZ**, a Danish painter and engraver; born at Copenhagen, Oct. 25, 1820. In 1840 he visited Munich and Dresden, and was a pupil of Bendemann; visited the Tyrol and reached Rome in 1850; went to Paris and entered the school of Couture. In 1856 he executed for the town of Flensburg, *Waldemar II*, and *Frédéric IV Recevant le Serment des Schleswigois*. He then undertook the illustration of some of the work of the chief Danish authors, including the *Histoire du Danemark* of Fabricius and *Le Contes* of Hans Christian Andersen and *Le Mythologie Scandinave*. He exhibited at the Salon, in 1863, *L'Amour et Psyché*; *Arrivée de la Reine Dagmar en Danemark* (1868); and at the Paris Exposition in 1878 the designs of *La Légende de l'Émigration des Longobards*.

**FRONDE, WAR OF**. See FRANCE, Vol. IX, p. 572.

**FRONTAL BONE**. See ANATOMY, Vol. I, p. 824.

**FRONTENAC, LOUIS DE BUADE, COMTE DE**, a French colonial governor of Canada, was born in 1620; died in Quebec, Nov. 28, 1698. He served in Holland under the Prince of Orange; at 23 was appointed colonel of a regiment in Normandy, and at 26 was made a brigadier. Having served in Italy, Flanders and Germany with marked success, he was appointed governor of New France (as the Canadian possessions were then called) in 1692. Frontenac modeled his government upon the old feudal pattern, and brought upon him a severe rebuke from the king of France. He quarreled with

the Jesuits, then all-powerful in Canada, and had a dispute with the governor of Montreal. Duchesneau was sent to Canada to administer the civil affairs of the province, Frontenac being allowed to retain the command of the army. Their relations became critical; Duchesneau sided with the Jesuits, while Frontenac violently opposed. The quarrel continued until both were recalled in 1682. In 1689, when the Iroquois were threatening Montreal, Frontenac was sent back. Though an old man, he was able to revive the courage of the colonists and to gain the respect of the Indians. He sent three war parties of French and Indians against the English, and finally repulsed Sir William Phips before Quebec in 1690. In 1696 he led an army into the heart of New York and laid waste Onondaga and Oneida. This, with the successes of Iberville, in Newfoundland, and on Hudson Bay, restored the fallen fortunes of the French. Though of a quarrelsome temper, Frontenac gained the respect and affection of the Indians by his conciliatory spirit and firmness.

**FRONT ROYAL**, a town and the capital of Warren County, northern Virginia, in the Shenandoah valley, on the Southern railroad, 64 miles W. of Washington, District of Columbia. It has a foundry and tannery, and wagon, furniture, tack, handle and cigar factories, and it also ships considerable farm produce. Population 1900, 1,005.

**FROST**. See METEOROLOGY, Vol. XVI, p. 849; and GEOLOGY, Vol. X, pp. 265, 280.

**FROST-BITE**. See SURGERY, Vol. XX, p. 683.

**FROSTBURG**, a village of Allegany County, western Maryland; located on a plateau between Dan's and the Great Savage Mountains, 1,792 feet above sea-level, and over the coal-basin of western Maryland. It is on the Cumberland and Pennsylvania railroad, mines coal, and has a fire-brick manufactory and foundries. Population 1900, 5,274.

**FROTHINGHAM, ELLEN**, an American translator; born at Boston, March 25, 1835, a daughter of Nathaniel Langdon Frothingham, the theological writer. She earned fame by translating Lessing's works, *Laocoon*, and *Nathan the Wise*, and Goethe's *Hermann and Dorothea*.

**FROTHINGHAM, NATHANIEL LANGDON**, an American clergyman and author; born in Boston, July 23, 1793. For a while he was an instructor in Harvard University, and from 1815 to 1850 was pastor of the First Congregational Church (Unitarian), in Boston. He contributed to various religious periodicals; and published, besides many sermons, *Deism or Christianity* (1845); *Sermons in the Order of a Twelvemonth* (1852); and *Metrical Pieces, Translated and Original* (1855). He died in Boston, April 4, 1870.

**FROTHINGHAM, OCTAVIUS BROOKS**, an American author, son of Nathaniel Langdon Frothingham; born in Boston, Nov. 26, 1822; graduated at Harvard in 1843, and in 1847 was ordained pastor of the North Church (Unitarian), at Salem, Massachusetts. In 1855-59 he was pastor in Jersey City, New Jersey, and in 1860-79 had charge of the Third Unitarian Congregational Church, New York City. In 1881 he withdrew from specific connec-

tion with any church, and devoted himself to literature. Mr. Frothingham has contributed to various periodicals, and published, besides more than 150 sermons, *Stories from the Lips of the Teacher* (1863); *Stories from the Old Testament* (1864); *Child's Book of Religion* (1866); *The Religion of Humanity* (1873); *Life of Theodore Parker* (1874); *Transcendentalism in New England* (1876); *The Cradle of the Christ* (1877); *Life of Gerrit Smith* (1878); *Life of George Ripley* (1882); and *Memoir of William Henry Channing* (1886). He died in Boston, Nov. 27, 1895.

FROTHINGHAM, RICHARD, an American historian; born in Charlestown, Massachusetts, Jan. 31, 1812. For years he was proprietor, and from 1852 to 1865 managing editor, of the *Boston Post*. In 1839, 1840, 1842, 1849 and 1850 he was a member of the Massachusetts legislature, and from 1851 to 1853 was mayor of Charlestown. For several years he was treasurer of the Massachusetts Historical Society. He published *History of Charlestown* (1848); *History of the Siege of Boston* (1849); *The Command of the Battle of Bunker Hill* (1850); *Life of General Joseph Warren* (1865); *Tribute to Thomas Starr King* (1865); and *Rise of the Republic* (1871). He died Jan. 29, 1880.

FROUDE, JAMES ANTHONY, an English historian, youngest son of the archdeacon of Totnes; born at Dartington, Devonshire, April 23, 1818. He was educated at Westminster and Oriel College, Oxford, and was elected a fellow of Exeter College in 1842. He took deacon's orders in 1844, published *Shadows and Clouds* in 1847, which showed his revolt from the Oxford leaders, and in 1848 *The Nemesis of Faith*, in which the solemnity and sadness



JAMES A. FROUDE.

of religious skepticism are relieved by a singularly tender and earnest humanity. The book was written with great power, and cost Froude his fellowship, and an educational appointment in Tasmania. He afterward endeavored to suppress both these works. For the next few years he employed himself in writing for *Fraser's Magazine* and the *Westminster Review*, and in 1856 issued the first two volumes of his *History of England from the Fall of Wolsey to the Defeat of the Spanish Armada*, completed in 12 volumes in 1869. In this work Froude displays supreme literary ability, but, like Macaulay, who, in the art of making history as fascinating as fiction, is his only rival, he is a man of letters first and a historian afterward, and his tailure as a dispassionate judge of historic events has sadly impaired the permanent value of his work. His views of men and motives are always distorted by being seen through nineteenth-century spectacles, and these, moreover, spectacles of his own. Four volumes of brilliant essays and papers, entitled *Short Studies on Great Subjects*, appeared between 1867 and 1882. He became rector of St. Andrew's University in 1869, and received the degree of LL.D. His next history, in

three volumes (1871-74), was *The English in Ireland in the Eighteenth Century*. In 1874, and again in 1875, Froude visited the South African colonies on a mission from the home government, and published his impressions in *Two Lectures on South Africa*, in 1880. As Carlyle's literary executor, Froude edited his *Reminiscences* in 1881, Mrs. Carlyle's *Letters* in three volumes in 1882, and Carlyle's own *Life* in four volumes (1882-84). In these volumes he gives a distorted view of the Chelsea sage, that aroused much deserved censure upon Froude. Among his several later works are *The Two Chiefs of Dunboy*, published in 1889, a historical romance of Irish life toward the close of the eighteenth century; a *Life of Lord Beaconsfield*, in 1890; *Divorce of Catharine of Aragon* (1891); *Life and Letters of Erasmus* (1894). In 1892 he succeeded E. A. Freeman (q.v., in these Supplements) as regius professor of modern history at Oxford. He died at Salcombe, Devonshire, Oct. 20, 1894.

FROUDE, WILLIAM, an English naval engineer, brother of James Anthony Froude; born in 1810; educated at Oriel College, where he took a first class in mathematics in 1832, and became known as one of the most skilled masters of applied mathematics in modern times. He served on Lord Dufferin's committee on the designs upon which ships of war have been constructed, and also upon the committee to report upon the stability of the turret-ship *Inflexible*. His labors included investigations on wave-resistance, the oscillations of ships, the usefulness of bilge-keels, frictional air and wave-making resistances, the ratio of effective to indicated horse-power, and on the best form of screw-propellers and rudders. While on a cruise to the Cape of Good Hope, he died at St. Simon's Town, May 4, 1879.

FRUCTIDOR, the name of a month in the French Republican calendar of 1792-1806, covering the days from August 18th to September 16th. See FRANCE, Vol. IX, p. 606.

FRUIT-CULTURE. See HORTICULTURE, Vol. XII, pp. 268-278.

FRUIT-PIGEON (*Carpophaga*) a genus of brilliantly colored pigeons of large size, found in the islands of the Indo-Pacific. They feed on fruits, hence the name.

FRUITPORT, a summer resort and center of a fruit region in Muskegon County, central eastern Michigan, at the mouth of Grand River, on the Chicago and West Michigan railroad, eight miles S. of Muskegon. It has Spring Lake magnetic mineral well, a muriated sodic saline spring. Population 1890, 300; 1900, 311.

FRUIT TREE. See BOTANY, Vol. IV, pp. 148-153.

FRUSTUM. See MENSURATION, Vol. XVI, pp. 23-26.

FRY, SIR EDWARD, an English jurist; born at Bristol, in the county of Somerset, Nov. 4, 1827. He was educated at Bristol and University colleges, and in 1851 graduated with honors at the University of London. Choosing the legal profession for his vocation, he was called to the bar at Lincoln's Inn in 1854 and became a queen's counsel in 1869. In April, 1877, he was appointed a judge of the chancery division of the High Court of Justice, and re-

ceived the honor of knighthood. In April, 1883, he was appointed one of the Lords Justices of Appeal and was sworn of the Privy Council. His chief title to fame was his masterly and lucid *Treatise on the Specific Performance of Contracts, Including Those of Public Companies* (1858), which has entered upon many editions in England and America and is the standard text-book on specific performance in every Anglo-Saxon court. His other works include *The Doctrine of Election* (1864); *Essays on the Accordance of Christianity with the Nature of Man* (1867); *Darwinism and Theology* (1872); and *British Mosses* (1892).

FRY, JAMES BARNET, an American soldier; born at Carrollton, Illinois, Feb. 22, 1827; graduated at West Point in 1847, fought in Mexico, and was adjutant at West Point from 1854 to 1859. He became assistant adjutant-general in March, 1861, and was chief of staff to General Irwin McDowell and Gen. D. C. Buell. On March 17, 1863, he became provost marshal-general of the United States, which position he held until August, 1866. His *Final Report* in connection with this bureau was published as a Congressional document in 1866. He received a major-general's brevet in 1865 and retired from active service in June, 1881. He published *Sketch of the Adjutant-General's Department, United States Army from 1775 to 1875* (1875); *History and Legal Effects of Brevets in the Armies of Great Britain and the United States* (1877); *Army Sacrifices* (1879); *McDowell and Tyler in the Campaign of Bull Run* (1884); *Operations of the Army under Buell* (1884); and *New York and the Conscriptio* (1885). He died in Newport, R. I., July 11, 1894.

FRY, WILLIAM HENRY, an American musician and journalist; born in Philadelphia, Pennsylvania, Aug. 10, 1815; died in Santa Cruz, West Indies, Dec. 21, 1864. He received an education at Philadelphia and Emmittsburg, Maryland, and in 1839 became employed as a writer for his father's newspaper, the *Philadelphia Gazette*. In 1835 he began a thorough study of music, and wrote, for full orchestra, four overtures that were performed in public. In 1845 he produced his English opera, *Leonora*, in New York and Philadelphia. In 1846 Fry was engaged as European correspondent for the *New York Tribune* and some other journals. He remained abroad until 1852, when he returned to New York City to become musical editor of the *Tribune*. He wrote the music to an ode for the opening of the New York Industrial Exhibition of 1853, delivered a number of lectures on musical subjects, and also produced two symphonies, *The Breaking Heart* and *A Day in the Country*.

FRYE, WILLIAM PIERCE, an American statesman; born at Lewiston, Maine, Sept. 2, 1831; graduated at Bowdoin College, Maine, 1850; studied and practiced law; was a member of the state legislature in 1861-62 and 1867; was mayor of the city of Lewiston in 1866-67; was attorney-general of the state of Maine from 1867 to 1869; was elected a member of the National Republican Executive Committee in 1872, re-elected in 1876. In 1880 he was elected a trustee of Bowdoin College; received the degree of LL.D. from Bates College in July, 1881, and the same degree

from Bowdoin College in 1889. He was a Presidential elector in 1864; was a delegate to the National Republican conventions in 1872, 1876 and 1880; was elected chairman of the Republican State Committee of Maine in place of J. G. Blaine, resigned in November, 1881; was elected a Representative in the Forty-second, Forty-third, Forty-fourth, Forty-fifth, Forty-sixth and Forty-seventh Congresses; was elected to the United States Senate as a Republican to fill the vacancy occasioned by the resignation of James G. Blaine, appointed Secretary of State; took his seat March, 1889, and was re-elected in 1883, again in 1891, and for a fourth time in 1895, his term expiring March 3, 1901.

FRYKEN, a chain of lakes in Wernland, southern Sweden, stretching from north to south over a distance of about 40 miles and discharging into Lake Wener by the Nors. They are surrounded by some of the finest scenery in Sweden.

FRYXELL, ANDERS, a Swedish historian; born Feb. 7, 1795, in Dalsland; died in Stockholm, March 21, 1881. He took priest's orders in 1820, and in 1828 became rector of a gymnasium in Stockholm. From 1847 until his death he devoted himself entirely to literary pursuits. His reputation rests upon *Narratives from Swedish History* (46 vols., 1832-80). These narratives, largely biographical in form, soon obtained popularity in Sweden, and parts of them have been translated into almost all European languages. Another work, *Conspiracies of the Swedish Aristocracy* (4 vols., 1845-50), was intended as a reply to the accusations urged against that class by Geiger and others, and involved Fryxell in a keen controversy with the Democratic-Liberal party in Sweden. Besides these works he wrote a *Contribution to the History of the Literature of Sweden* (9 vols., 1860-62).

FUCA OR JUAN DE FUCA, STRAIT, a passage separating the state of Washington from Vancouver Island, and connecting the Pacific Ocean with the Gulf of Georgia. It contains several islands, one of which, San Juan, became the subject of a dispute between Great Britain and the United States, the question being whether it belonged to Washington (then a territory) or to British Columbia. In 1872 the Emperor of Germany, as arbiter, decided that the line of boundary should be run through the Strait of Haro, west of San Juan, thus awarding that island to the United States, and it and several neighboring islands now form a county of Washington.—JUAN DE FUCA was a Greek navigator, born in Cephalonia, his real name being Apostolos Valerianos. He was for many years in the service of Spain. When he discovered the strait which bears his name, he believed it to be a passage between the Atlantic and the Pacific oceans. He died at Zante, in 1602. See also WASHINGTON, Vol. XXIV, p. 387.

FUCACEÆ, a group of coarse olive-green seaweeds, belonging to the *Phaeophyceæ*. Numerous species are known, growing mostly in salt water. Some attain a great size, as, for example, the well-known "gulf-weed" (*Sargassum bacciferum*), which is met with in large floating masses in all oceans. The common "kelps" are members of this group. *Fucus*

*vesiculosus*, with thallus buoyed up by bladders, is the common form of the Atlantic coast of the United States.

**FUCHSIN** OR **SOLFERINO**, a magnificent dye furnished by rosaniline hydrochloride, or magenta. All varieties of the different shades of magenta are salts of the colorless base rosaniline, which is obtained by precipitating, with an excess of ammonia, a solution of the pure hydrochloride, crystals of colorless needles and plates being obtained. The dye was discovered by a Frenchman (Renard), and named by him from *Fuchs* (fox), the German equivalent of his own name. It is used in dyeing silk and wool. It is commercially known as *aniline red*, or *rubin*.

**FUCINO** OR **FUCINUS LACUS**. See **CELANO**, Vol. V, p. 286; and **TUNNELING**, Vol. XXIII, p. 623.

**FUCUS**. See **ALGÆ**, Vol. I, pp. 507-509.

**FUENTES DE ONORO**, a small village of Salamanca, central western Spain, on the Portuguese frontier, 14 miles W. of Ciudad Rodrigo. This place is celebrated as the scene of one of the important battles of the Peninsular War, between the French under Massena and the English under Wellington. Population, 1,400.

**FUERTEVENTURA**. See **CANARY ISLES**, Vol. IV, p. 800.

**FUGHETTO** AND **FUGUE**, in music. See **MUSIC**, Vol. XVII, pp. 82, 83.

**FUGITIVE SLAVE LAWS**. See **UNITED STATES**, Vol. XXIII, pp. 747, 751, 768, 770.

**FUHKIEN** OR **FUHKEEN**. See **CHINA**, Vol. V, p. 636.

**FUJI SAN** OR **FUSIYAMA**. See **JAPAN**, Vol. XIII, p. 571, and note.

**FULDA**, a town of Hessen-Nassau, central eastern Germany, on several railways, and on the Fulda River, 53 miles N.E. of Frankfurt. It has a cathedral, built after the style of St. Peter's at Rome, and was from 1734 to 1803 the site of a university, and of a famous mediæval monastery, for which see **FULDA**, Vol. IX, pp. 812, 813.

**FULGENTIUS**, **FABIUS CLAUDIUS GORDIANUS**, **SAINT**, known, on account of his writings, as the "Augustine of the sixth century"; born at Telepte, on the estate of his father, in the province of Byzacene, in Africa, A.D. 468. He was intended for the public service, but after being, for a short time, procurator fiscal of the province, he retired to a monastery, and became noted for his ascetic conduct. He visited Rome in A.D. 500, and on his return to Africa founded a monastery. In A.D. 508 he became bishop of Ruspe, or Ruspina. He was noted for his defense of the Roman Catholic Church against Arianism. The Vandals having gained a temporary ascendancy, their king, Thrasimund, consequently exiled the bishop to Sardinia. On the death of this king, Fulgentius was restored to his see and enjoyed peace for the remainder of his life, a period of ten years, his death occurring in A.D. 533. He was distinguished for his piety and for his virtue. His works, written in Latin, included treatises on the Trinity, predestination, faith and Arianism. He had opinions similar to those of Augustine, and imitated his style. His name appears in Roman

Catholic calendars on the first day of January, the supposed day of his death.

**FULGURITES** OR **FULMINARY TUBES** are tubes of vitrified sand originating from the action of lightning. They are found in sand-banks and sandy soils, and vary from a quarter of an inch to two inches and a half in diameter. Internally their surface is glassy, and hard enough to scratch glass, and produce fire when struck with steel. They are usually vertical in the sand, becoming narrower downward, and sometimes branched.

**FULHAM**, a suburb of London, on the Thames, 4½ miles W.S.W. of Charing Cross. It has a palace, the summer residence of the London bishops. It returns one member to Parliament. Population 1891, 188,877.

**FULLER**, **GEORGE**, an American portrait-painter; born in Deerfield, Massachusetts, in 1822; died March 21, 1884. He studied painting under Henry Kirke Brown, was elected an associate of the National Academy, and exhibited largely from 1873 until his death. He was especially remarkable as a colorist. Among his works are *Romany Girl*; *And She Was a Witch*; *Quadroon*; *Winifred Dysart*; *Turkey Pasture in Kentucky*; *By the Wayside*; *Arcthusa*, purchased for \$6,000 by the Art Museum of Boston; *Psyche*; *H. K. Brown* (a portrait); etc.

**FULLER**, **MELVILLE WESTON**, an American jurist; born in Augusta, Maine, Feb. 11, 1833; graduated at Bowdoin College in 1853. He studied law at Bangor, Maine, and at Harvard, and in 1855 began practice in his native city. Here he edited the *Augusta Age*, became president of the common council, and in 1856 city attorney. In the last-named year he removed to Chicago, where, for thirty-two years, he conducted a highly successful law practice. Mr. Fuller was a member of the Illinois constitutional convention in 1862, and of the Illinois house of representatives in 1863. A strong Democrat, he served as a delegate to all the national conventions from 1864 to 1880, inclusive. President Cleveland nominated him chief justice of the United States supreme court, April 30, 1888, and he was confirmed by the Senate July 20th, and took the oath of office October 8th following.



MELVILLE W. FULLER.

**FULLER**, **SARAH MARGARET**. See **OSSOLI**, **SARAH MARGARET FULLER**, **MARCHIONESS**, Vol. XVIII, p. 57.

**FULLERTON**, a town and the capital of Nance County, eastern central Nebraska, on the Loup River, and on the Union Pacific railroad. It is the seat of Nebraska Wesleyan University. Population 1890, 1,200.

**FULLERTON**, **LADY GEORGIANA**, a British writer of religious novels, daughter of the first Earl Granville; born in Staffordshire, Sept. 23, 1812; died at Bournemouth, Jan. 19, 1885. In 1833 she married

Alexander Fullerton, and two years afterward published her first story, *Ellen Middleton*. Under the influence of the Tractarian movement she became, in 1844, a convert to Roman Catholicism. The rest of her life was devoted to charitable works and the composition of religious stories, among which were *Grantley Manor*; *Constance Sherwood*; *A Stormy Life*; *Mrs. Gerald's Niece*; and *Gold-digger, and Other Verses*.

FULLING. See WOOL, Vol. XXIV, p. 661.

FULMINATES. See EXPLOSIVES, Vol. VIII, p. 808.

FULMINIC ACID has never been isolated, but its formula is  $H - O - N = C$ . It is one of the few substances in which carbon is bivalent. Its salts are very explosive. See EXPLOSIVES, Vol. VIII, p. 808.

FULTON, a town in Fulton township, Whiteside County, northwestern Illinois, opposite Clinton, Iowa, on the Mississippi River; an important railroad junction, and the depot of much grain from Wisconsin, Minnesota and northwestern Illinois. It has a large elevator, carriage, pipe, and stoneware factories, and is the seat of Northern Illinois College. Population 1890, 2,099; 1900, 2,685.

FULTON, a city of Fulton County, southwestern Kentucky, on the state boundary, five miles N. of Union City, on the Mobile and Ohio railroad. It contains two seminaries, and establishments where cotton-ginning and wool-carding are carried on, and where wagons, tobacco, lumber and flour are manufactured. Population 1890, 1,818; 1900, 2,860.

FULTON, a city and the capital of Callaway County, east-central Missouri, on the Chicago and Alton railroad, 28 miles N.W. of Jefferson City. It contains Westminster College, state asylums for the deaf and dumb and for the insane, and two state institutions under Presbyterian control. The neighborhood abounds in coal and fire-clay, and cattle-raising and farming are extensively carried on. The city has fine water-works. Population 1890, 4,314; 1900, 4,883.

FULTON, a village of Oswego County, northern central New York, on Oswego River, 12 miles S.E. of Oswego, and on the Delaware, Lackawanna and Western railroad. It has good water-power, a seminary, an academy and several factories, among them those of flour, buckwheat, edged tools, paper, firearms, pulleys and paper-mill machinery. Population 1890, 4,214; 1900, 5,281.

FULTON, JUSTIN DEWEY, an American clergyman; born at Earlville, New York, March 1, 1828; became a Baptist minister in 1853. He held pastorates in St. Louis, Sandusky, Ohio; Albany, New York; Boston and Brooklyn. He was a voluminous author, a strong temperance man, and a bitter opponent of Roman Catholicism. He received the degree of D.D. from the University of Rochester in 1871; and was the author of *The Roman Catholic Element in American History* (1859); *Life of Timothy Gilbert* (1864); *Woman as God Made Her* (1867); *The Way Out* (1870); *Show Your Colors* (1881); *Rome in America* (1884); etc.

FULTONVILLE, a village of Montgomery County, central eastern New York, on the Mohawk

River and on the Erie canal, 40 miles W. of Albany, directly opposite Fonda, on the West Shore railroad. It has steam-mills, a grain-elevator, a foundry and machine-shops. Population 1900, 977.

FULVIA, a bold and ambitious woman of Rome, the daughter of M. Fulvius Bambalio of Tusculum. She was thrice married: first to P. Clodius, by whom she had a daughter, afterward the wife of Octavianus; secondly, to C. Scribonius Curio; and thirdly, to Marc Antony, by whom she had two sons. In the conscription of 43 B.C., planned by the triumvirate, Octavianus, Antony and Lepidus, Fulvia acted with great wantonness, gloating over the head of Cicero, who had fallen under the vengeance of Antony. She loved her husband Antony, but was of a most jealous disposition, and when Antony was in Egypt, she induced Lucius Antony, her husband's brother, to take up arms against Octavianus, whom she feared, and also to endeavor to withdraw Antony from Egypt. Lucius, however, was defeated by Octavianus, and was compelled to surrender the following year (40 B.C.). Fulvia met Antony at Athens and was cruelly treated by him; she went to Sicyon in despair, and died the same year. After her death Antony married Octavia, sister of Octavianus, this marriage facilitating the reconciliation of Antony with Octavianus.

FUMIGATION, the cleansing or medicating of the air of an apartment by means of vapors, employed chiefly for the purpose of detaching infectious poisons from clothing and furniture. Most of the methods of fumigation formerly employed have little real value, and are to be looked on chiefly as grateful to the senses; as, for instance, the burning of frankincense. For the really active processes, see DISINFECTANTS, Vol. VII, p. 258.

FUNCHAL. See MADEIRA, Vol. XV, p. 179.

FUNDAMENTAL, in music. See MUSIC, Vol. XVII, pp. 100, 101.

FUNDS. See NATIONAL DEBT, Vol. XVII, p. 245.

FUNDY, BAY OF. See NEW BRUNSWICK, Vol. XVII, p. 373.

FÜNEN OR FÜHNEN (Dan., *Fyn*), the largest of the Danish islands after Zealand, is separated from Jutland and Schleswig, Germany, on the west by the Little Belt, and from Zealand on the east by the Great Belt. With the islands of Langeland, Arö, Taasinge and the included islands, it forms the two administrative districts of Odense and Svendborg. Area of Fünen, 1,135 square miles; population 1893, 206,528.

FUNGICIDES, preparations used for combating or preventing the fungous diseases which attack plants or animals. The diseases of plants are mostly known and classified, but new diseases appear, from time to time, that baffle the knowledge of the scientist. Any unknown disease attacking plants is commonly classed as of fungous origin, and to be treated with fungicides. The recent rapid increase in the knowledge of fungi, their origin and propagation, and the damages they inflict, led to extensive experiments to discover, if possible, some easily applied inexpensive antidote that should prove fatal to the fungi without injuring the plant or the fruit

growing upon it. These experiments have demonstrated the efficacy of certain solutions of copper and lime, or of copper and ammonia, and of potassium sulphide, in destroying the fungi before these are developed upon the leaf or fruit-bud, or of preventing their appearance upon grains by treating the seeds prior to seeding or planting. The destruction of the fungi after full development, without, at the same time, destroying or seriously injuring the plant, seems to be extremely difficult, or impossible, and the remedy ordinarily used in such instances is the total destruction of the plants affected. The application of fungicides varies with

gether 20 pounds of resin,  $4\frac{1}{2}$  pounds of caustic soda ( $98^\circ$ ), 3 pints of crude fish-oil, and 15 gallons of water, until the resin is thoroughly dissolved. When used, the mixture is further diluted with about 10 parts of water. The wash is applied in January or February, again in two weeks, and a third time in August. To prevent smut in wheat, oats or barley, the seed is dipped in hot water for 15 minutes; the water must be above  $130^\circ$ , so as to kill the fungous spores, and never rise above  $135^\circ$ , lest the grain be injured. Before its hot-water plunge the grain is first warmed by immersion in hot water of a lower temperature.

The following table gives some of the principal fungous diseases, with times of treatment, the fungicides to be used, indicated by number, referring to formulas *ante*.

	FIRST APPLICATION.	SECOND APPLICATION.	THIRD APPLICATION.	FOURTH APPLICATION.
Apricot or almond shot-hole fungus.	No. 2, when leaves unfold.	Same in 10 or 12 days.	Same, 14 days later.	Same, 14 days later.
Apple-scab.	No. 1, when fruit-buds are unfolding.	Same, when flower-clusters are expanding.	Same, when petals are falling.	Same, when fruit is $\frac{1}{2}$ inch in diameter, if needed.
Cherry-leaf blight.	No. 1, after foliage is fully developed.	Same, 14 days later.	Same, 14 days later.	Same, 14 days later.
Cherry or plum black-knot.	No. 1, just before leaves appear.	Same, 2 weeks later.	Same, 2 weeks later.	Same, 2 weeks later.
Grape black-rot.	No. 1, before buds open.	Same, when leaves are $\frac{1}{2}$ grown.	Same, just before blooming.	No. 2, 4 weeks after blooming.
Grape downy mildew.	No. 1, when buds first open.	Same, when leaves are $\frac{1}{2}$ grown.	Same, when in bloom.	Same, when fruit is $\frac{1}{2}$ grown.
Peach-curl.	No. 1, before buds unfold.	Same, when leaves are $\frac{1}{2}$ grown.	Same, 2 weeks later.	Same, 2 weeks later.
Pear scab.	No. 1, when fruit-buds open.	Same, just before blooming.	Same, when petals fall.	
Plum, prune and peach leaf rust.	No. 2, when in full leaf.	Same, 3 weeks later.	Same, 2 weeks later.	
Potato rot or blight.	No. 1, when plants are 6 inches high.	Same, 2 weeks later.	Same, 2 weeks later.	Same, 2 weeks later.
Quince fruit-spot and leaf-blight.	No. 1, after blossoms fall.	Same, 2 weeks later.	Same, 2 weeks later.	Same, 2 weeks later.

the occasion and the disease—either by dusting powder upon the plants, as in *Oidium*, or powdery mildew on grapes, treated by dusting with sulphur when the vine is in full bloom, or by spraying a liquid solution over the affected plants, either by hand or by the aid of pumps especially designed for the purpose. Sometimes the treatment is by covering the plant with a tent of light cloth, and passing under the tent the fumes of burning fungicides. This method is rarely practicable, and belongs rather to the insecticide remedies.

The principal fungicides in use are,—

No. 1. *Bordeaux mixture*. Made of copper sulphate, 6 pounds; strong, fresh lime, 4 pounds; water, 22 gallons. The sulphate to be dissolved in a portion of the water, the lime slacked separately, and then slowly added when the mixture is ready for use, either by sprinkling or spraying.

No. 2. *Ammoniacal copper carbonate*. Copper carbonate, 5 ounces; ammonia ( $26^\circ$ ), 3 pints; water, 50 gallons. Dissolve the carbonate in the ammonia and add the water.

No. 3. *Potassium sulphide*. Composed of  $2\frac{1}{2}$  ounces of potassium sulphide to 5 gallons of water; used as a spray for mildew on greenhouse plants, for apple and pear scab, celery-leaf blight, etc.

No. 4. *Corrosive sublimate solution*. Made by adding  $2\frac{1}{2}$  ounces of corrosive sublimate to 15 gallons of water. This is used for prevention of potato-scab, the potatoes, before planting, being soaked in the solution for an hour or more. The solution is poisonous and dangerous.

No. 5. *Resin wash*, which is much used to destroy the sooty mold on orange trees, is prepared by boiling to-

FUNGUS. See MORPHOLOGY, in these Supplements.

FUNSTON, EDWARD H., an American statesman, was born in Clarke County, Ohio, in 1836. Educated in the common schools, New Carlisle Academy and Marietta College, he entered the army in 1861 as lieutenant in the Sixteenth Ohio Battery. Mustered out in 1865, he located in Kansas, and was a member of the Kansas house of representatives from 1873 to 1875, of which he was speaker in 1875. He was elected state senator in 1880 and was made president *pro tem.* of the senate. He was a member of the Forty-eighth to the Fifty-second Congresses, inclusive, as representative of the Second district of Kansas. He failed to secure a renomination in 1894.

FÜRBRINGER, MAX, a German anatomist; born at Wittenberg, Jan. 30, 1846; studied at the universities of Jena and Berlin; engaged in special work under the most noted anatomists of Germany. He became anatomical assistant to Gegenbauer; extraordinary professor of anatomy at Heidelberg; professor of descriptive and comparative anatomy and embryology and director of the anatomical institute at Amsterdam in 1879-88, after which he was appointed professor at Jena. His most important work is *Untersuchungen zur Morphologie und Systematik der Vögel* (1888), which is recognized as the



great standard work on the subject of the anatomy and morphology of birds. He also wrote monographs on the bones and muscles of the extremities of the serpentine saurian, on the comparative anatomy of the shoulder muscles, and on the growth and development of the nerve plexus.

**FURFURAMIDE, FURFURINE AND FURFUROL.** When starch, sugar or bran is acted upon by dilute sulphuric acid and peroxide of manganese, the distillate contains not only formic acid, but also a small quantity of an essential oil, which, after being purified by redistillation, is colorless, has a fragrant odor somewhat resembling that of bitter almonds, and when dissolved in cold sulphuric acid forms a beautiful purple liquid. This oil is termed furfurol. Its formula is  $C^4H^3O.CO.H$ , and it belongs to the class of aldehydes.

**FURLONG,** a land measure; literally, a "furrow long." See **WEIGHTS AND MEASURES**, Vol. XXIV, p. 489.

**FURNACE.** See **IRON**, Vol. XIII, pp. 291-327.

**FURNACE, ELECTRIC.** See **CHEMISTRY**, in these Supplements.

**FURNACE PRACTICE, BLAST.** See **IRON AND STEEL**, in these Supplements.

**FURNACES.** The increased demand for furnaces for the heating of dwellings and other buildings has caused the development of a very large number of styles of furnaces and heaters, operating mostly by steam, hot water, hot air or electricity, and consuming coal or gas as fuel. The use of steam for such heating is mostly confined to large buildings, it being generally conceded that for dwellings and buildings of moderate size a simpler system is superior.

The hot-air furnaces are probably the most common for this purpose. The most recent patterns consist, usually, of a fire-pot and grate, surmounted and partly surrounded by a radiator, the whole being incased with either brick or sheet-iron, to keep in the heat. From within this casing large pipes are led to the different rooms to be heated, dampers serving to cut off the heat from any pipe or pipes as desired, and registers being located at the ends of the pipes in the rooms served, to regulate the entrance of heat at the terminal points of the system. Of this type of furnace is the Boynton, having a patent draft-regulator, draw-center grates, cast-iron radiator made in one solid piece, and minor conveniences; the Ridgway, having a revolving open fire-pot, made in sections, to allow of expansion and contraction without cracking, and revolved on balls to reduce friction; the Magee, having a central pipe in the radiator; the Carton, designed for using soft coal; the Hub, having large perpendicular pipes outside of the radiator; the Peninsular, having duplex grate and annular shaking-ring, as also a damper for turning all the draft directly into the smoke-pipe when starting a fire.

The hot-water system of heating operates on the principle that hot water is lighter than cold, and will always rise to the top, while the colder and heavier water descends, thus producing a constant circulation through pipes distributed in a building. The same class of furnaces may be used as with the hot

air, with the necessary changes in mechanism to provide for heating the water. There is no danger from pressure, as with steam, and the heat in the pipes is maintained much longer after the fire is out than with any other system. It is also cheaper than steam-heating. In the Boynton hot-water furnace a series of horizontal pipes are set above the fire-pot, so that the heat circulates on all sides of them. The hot water is distributed from the top of the furnace, and the return-pipes enter below. Tests made with a hot-water furnace and a hot-air furnace of the same make, for a period of four months, under as nearly similar conditions as possible, indicated a saving of fuel with the hot-water service of 33 per cent.

Gas-furnaces are built for both hot-air and hot-water heating. A common type of hot-air gas-furnace consists of an upright drum for the burners. At the top of the drum is a hollow dome-like ring, through which the heated air passes, turning downward through a series of corrugated pipes to a lower hollow outlet ring, connecting with the pipes through which the heat is to be distributed through the building. The drum and pipes are all inclosed within a casing to retain the heat. The lower part of the furnace-drum is lined with fire-brick, and as the highly heated products of combustion rise into the upper ring or dome, the forced draft created draws in what air is necessary for the complete combustion of the gas. When such a gas-furnace is arranged for heating by the hot-water system, a series of pipes or rings is arranged so as to secure a large heating-surface for the water that flows through.

Electric heaters are made in several different designs, a common form consisting of a framework of thin cast-iron, with outer castings having numerous projections for radiating the heat. Within are coils of resistance-wire. The amount of heat depends upon the strength of the current turned through the heater. A three-foot heater, on a 110-volt circuit, will consume anywhere from five to twenty amperes, under ordinary conditions. In heating a building in this manner, no furnace at all is required. The heaters are simply distributed where wanted, and connected by wires, so that the current may be turned on and off, like that of an incandescent electric lamp.

C. H. COCHRANE.

**FURNEAUX ISLANDS,** a group of British islands in Bass's Strait, off the north coast of Tasmania, or Van Diemen's Land, lat.  $40^{\circ}$  S., long.  $148^{\circ}$  E.; discovered in 1773 by the English navigator, Furneaux. They are numerous, the largest being 35 miles in length and 10 in breadth. The soil is sandy and the vegetation feeble.

**FURNES,** a small town, the westernmost of Belgium, near Dunkirk. Four important lines of canal meet at this town, and it has tanneries and linen manufactures, as well as a considerable trade in horses, cattle, hops and cheese. Population, 5,322.

**FURNESS, HORACE HOWARD,** an American scholar; born in Philadelphia, Nov. 2, 1833; son of Dr. W. H. Furness. He was graduated at Harvard in 1854; traveled three years in Europe, and in 1859 was admitted to the Pennsylvania bar. He was

a diligent student of Shakespeare, and undertook the editing of a new *variorum* edition of the works of the



HORACE H. FURNESS.

Bard of Avon. He received the honorary degree of Ph.D. from Göttingen for his Shakespearean erudition. Of this edition he published *Romeo and Juliet* (1871); *Macbeth* (1873); *King Lear* (1880); *Othello* (1886); *The Merchant of Venice* (1888); *As You Like It* (1890); *The Tempest* (1892). This labor of Dr. Furness was received with the most enthusiastic praise in literary circles in all lands. Of the Variorum edition, *Blackwood's Magazine* said: "America has the honor of producing the very best and most complete edition of our great national poet." Of Dr. Furness it said: "The editor combines with the patience and accuracy of the textual scholar an industry which has overlooked nothing of value that has been written about Shakespeare by the best German and French as well as English commentators and critics; and, what is of no less account, he possesses in himself a rare delicacy of literary appreciation and breadth of judgment, disciplined by familiarity with all that is best in the literature of antiquity as well as of modern times, which he brings to bear in his notes with great effect." Other British critical journals gave him equal praise.

FURNESS, WILLIAM HENRY, an American clergyman; born in Boston, April 20, 1802; graduated at Harvard College in 1820, and in 1825 ordained to the first Unitarian church in Philadelphia, Pennsylvania, where he remained until 1875, when he retired from the ministry. From 1845 to 1847 he edited an annual called *The Diadem*. He was the author of *Remarks on the Four Gospels* (1836); *Jesus and His Biographers* (1838); *A History of Jesus* (1850-53); *Domestic Worship* (1842); *Julius, and Other Tales*, from the German (1856); *The Veil Partly Lifted and Jesus Becoming Visible* (1864); besides translations of works of German theologians and poets. He received the degree of doctor of letters from Columbia College in 1887. He died in Philadelphia, Jan. 30, 1896.—His son, WILLIAM HENRY FURNESS, JR., a portrait-painter, was born in Philadelphia, May 21, 1828. After being employed as a clerk for a short time, his artistic instincts asserted themselves, his expertness being most evident in crayon-work. He went abroad and studied at Munich, Dresden and Venice. On his return to America he had his studio at Boston. Among those who sat to him were Lucretia Mott, Edith May, Charles Sumner, Dr. Furness, John W. Field, Hamilton Wilde and others. He died at Cambridge, Massachusetts, May 4, 1867.

FURNISS, HARRY, a British caricature artist; born March, 1854, at Wexford, Ireland, of English parents. He was educated in Dublin, and began drawing for periodicals and magazines at a very early age. Mr. Furniss went to London at the age

of 19, and from that time on was engaged in illustrating. For many years he was a regular contributor to the *Illustrated London News*, mostly depicting the lighter side of every-day life, but occasionally acting as a serious "special" for that paper. In the latter capacity he made a sketching tour of the distressed parts of England in the winter of 1878, and followed political campaigns through the country, etc. His first drawing in *Punch* appeared in 1880, and he joined the regular staff four years after; at this time his *Punch Parliamentary Views* were collected and published in an *édition de luxe*. His principal works in *Punch* are *Parliamentary Scenes, and Sketches of Members*, with few exceptions drawn direct in the Houses and finished in the studio. Besides his work in *Punch* he has illustrated the following works, published from the same office: F. C. Burnand's *Happy Thoughts*; A'Beckett's *Comic Blackstone*, colored plates; and Burnand's *Incomplete Angler*. He contributed drawings to nearly all the chief magazines in London, Harper's in America, and others, and to numerous papers, the *World* and *Vanity Fair* among them. He also brought out books for children, with colored pictures, entitled *Romps*. In 1890 he was elected a fellow of the Institute of Journalists. In 1894 he retired from the staff of *Punch*, and established a weekly journal called *Lika Joko*. On the abandonment of *The Pall Mall Budget*, the weekly edition of William Waldorf Astor's *Pall Mall Gazette*, on the death of the latter's wife, whose favorite journal it was, Mr. Furniss purchased the plant of the defunct paper and brought out *The New Budget*, making it in every respect a fac-simile of the former. *Lika Joko* was discontinued at the end of the year.

FURNIVALL, FREDERICK JAMES, an English philologist; born Feb. 4, 1825, at Egham, in Surrey; received his education at private schools at Englefield Green, Turnham Green and Hanwell, at University College, London (1841-42), and Trinity Hall, Cambridge (1846-49). He was called to the bar in 1849, but devoted his life mainly to the study of Early and Middle English literature, and established numerous societies, of which he was director, for promoting the study of special works: The Early English Text, 1864; the Chaucer, 1868; the Ballad, 1868; the New Shakespeare, 1873; the Wyclif, 1882; the Browning, 1881; and the Shelley, 1885. Through his societies Dr. Furnivall raised and expended over forty thousand pounds in printing early MSS. and rare books. He was also one of the founders of the Working Men's College, and taught there for many years, besides being a captain in its volunteer corps and president of its boat-club. He was one of the first builders of narrow wagher-boats, in 1845, and introduced sculls instead of oars into fours and eights. Dr. Furnivall edited a large number of early English and other works, among which may be mentioned Walter Map's *Queste del Saint Graal*; *Percy's Folio MS. of Ballads and Romances*; *The Babies' Book*; Harrison's *England* (1577-87); *Caxton's Book of Curtesye*; a six-text print of Chaucer's *Canterbury Tales* (a very valuable aid to the study of Chaucer), and parallel text editions of the poet's *Minor Poems* and *Troilus*

and *Cressida*, etc. To these may be added several of the Shakespeare quartos in fac-simile, and the introduction to a one-volume edition of the works called *The Leopold Shakspeare*.

FURRUCKABAD. See FARRACKHABAD, Vol. IX, p. 42.

FÜRSTENBURG, FRIEDRICH EGON VON, an Austrian primæ; born at Vienna, Austria, Oct. 8, 1812. He belonged to one of the princely families; became prince-archbishop of Olmütz in 1853, and in 1879 was made a cardinal priest, with the title of prince-assistant to the Holy See. He was a member of the imperial House of Lords and a councillor of state. Died in Hochwald, Moravia, Aug. 19, 1892.

FURY AND HECLA STRAIT, in lat. 70° N., long. 85° W., separates Melville Peninsula from Cockburn Island, and connects Fox Channel with the Gulf of Boothia. It was discovered by Parry in 1822, and named after his ships.

FUSAN, one of the three open ports of Corea, on the southeast shore of the peninsula, at the mouth of Nak-Forq River, and practically a Japanese settlement under a treaty of 1876. The trade is almost entirely in Japanese hands, and in 1888, of 2,614 foreigners, the Japanese numbered 2,595. The imports in 1887 (chiefly Manchester goods, salt and Japanese wares) were valued at \$659,000, the exports (rice, beans, hides, etc.), excluding specie, at \$394,000. There are good custom stores, and regular communication by steamers with Shanghai, Nagasaki and Vladivostok, and by telegraph with Seoul.

FUSARA, LAKE OF, a small lake of Campania, central Italy, 11 miles W. of Naples, called by the Romans Acherusia Palus. It is near the site of the ancient Cumæ, and during the Roman Empire its banks were studded with villas. Numerous remains of massive buildings, houses and tombs are still to be seen in the neighborhood. The water of the lake is brackish. Oysters have been cultivated here since the time of the Romans.

FUSEE. See WATCH, Vol. XXIV, p. 394.

FUSIBILITY. See METALS, Vol. XVI, pp. 66, 67.

FUSILIERS, formerly soldiers armed with a lighter fusil, or musket, than the rest of the army, but at present all regiments of foot carry the same pattern of rifle. Fusilier is therefore, simply a historical title borne by a few regiments of the British army.

FUSIYAMA. See *Fuji San*, under JAPAN, Vol. XIII, p. 571.

FUSTEL DE COULANGES, NUMA DENIS, a French historian; born in Paris, March 18, 1830; died Sept. 12, 1889. After filling several chairs successively at Amiens, Paris and Strasburg, he was transferred in 1875 to the École Normale, at Paris, and became a member of the Institute in the same year. His earlier writings, *Mémoire sur l'Île de Chio* (1857) and *Polybe; ou, La Grèce Conquise par les Romains* (1858), had hardly prepared the reading

public for the altogether exceptional importance of his brilliant book, *La Cité Antique* (1864; 10th ed. 1885), which threw a flood of fresh light on the social and religious institutions of antiquity. The work was crowned by the French Academy, as was also his profoundly learned and luminous *Histoire des Institutions Politiques de l'Ancienne France* (vol. 1, 1875).

FUSUS, a genus of gasteropodous mollusks nearly allied to *Murex*, having a spindle-shaped shell. There are many tropical and subtropical species. The northern forms once included in the genus are now distributed in other genera.

FUTA JALLON. See GAMBIA, Vol. X, p. 59.

FUTTEHPOOR. See FATHIPUR, Vol. IX, p. 50.

FUTURE ESTATE, an estate which is to take effect in the future, either at some specified time or upon the happening of a certain contingency. This class of estates includes remainders, reversions and other estates which do not exist in the present, but are only in expectancy.

FUTURE LIFE. See ESCHATOLOGY, Vol. VIII, pp. 535-538.

FYAN, ROBERT W., an American lawyer; born in Bedford County, Pennsylvania, March 11, 1835, and removed to Marshfield, Missouri, in 1858. He was an officer in the United States army during the American Civil War; was circuit attorney of the fourteenth judicial circuit in 1865 and 1866, and judge of the same circuit from April, 1866, to January, 1883, when he resigned. In politics a Democrat, he was a member of the Missouri constitutional convention of 1875; was elected a Representative from the Thirteenth Congressional district of Missouri to the Forty-eighth Congress, and in 1890 and 1892 was elected from the same district, but retired in 1894.

FYFFE, CHARLES ALAN, an English historian; born at Blackheath, Kent, December, 1845; graduated from Balliol College, Oxford, in 1868; traveled on the Continent; was at the battle of Sedan in 1870, and sent the first account of the decisive struggle to *The Daily News*, London. He was called to the bar in 1876, but did not practice regularly, preferring literary pursuits. He wrote a *History of Greece*, published in 1875 in Macmillan's History Primers Series, and later an elaborate work, *A History of Modern Europe*, covering the period from 1792 to 1878 (3 vols., 1880-90). He also published a treatise on *The Land Question*. He died by suicide, in a condition of depression caused by a false charge, Feb. 19, 1892.

FYFFE, JOSEPH, an American naval officer; born at Urbana, Ohio, July 26, 1832; entered the navy Sept. 9, 1847, and after successive promotions was made commodore, Feb. 28, 1890, and rear-admiral, July 10, 1894. He was retired six days afterward. Of his 47 years' service he was on sea service 18 years. He died at Pierce, Nebraska, Feb. 25, 1896.

## G

## GABBRO—GADSDEN

**GABBRO.** See GEOLOGY, Vol. X, p. 235.

**GABINIUS, AULUS**, a Roman ruler and governor. The time of his birth is not known. He was tribune in 66 B.C., prætor in 61, consul with L. Piso in 58, and proconsul to Syria in 57. While tribune he proposed the celebrated Gabinian laws (see ROME, Vol. XX, p. 763). While in Syria he went over to Egypt and restored to power Ptolemy Auletes, who had been removed by order of the Roman Senate and by the Sibylline Books. He received for this act ten thousand talents from Auletes. Upon his return to Rome in 54 B.C., he was arrested for treason in disobeying the decree of the Senate, and for bribery. He was acquitted of the charge of treason, but was sent into exile for the acceptance of a bribe. He was restored by Cæsar in 49 B.C., and sent by that general to Illyricum, where he died, in 48 B.C.

**GABLENZ, LUDWIG CARL WILHELM, BARON VON**, an Austrian general; born in Jena, July 19, 1814. His first military service was in the army of Saxony. He engaged in the Austrian service as captain in 1833, and became colonel in 1848. He was for several years employed in the government executive and diplomatic service. He next attracted public attention by his conduct at the battles of Solferino and Caoriana in 1859. He was made lieutenant-marshal in 1863, and commanded the Austrian wing of the Prusso-Austrian army in the Schleswig-Holstein campaign against the Danes in 1864. He was, for a time, governor of Holstein, and after seeing active service in 1866 in the Austro-Prussian war, and negotiating the terms of peace with Prussia, retired from the army until 1867, when he again took the field, and in 1869 became the commanding general of Hungary. He retired permanently in 1871. Crazed by financial losses, he killed himself at Zurich, Jan. 28, 1874.

**GABOON.** See AFRICA, in these Supplements.

**GABORIAU, ÉMILE**, a French novelist; born at Saujon, in Charente-Inférieure, in 1835; died in Paris, Sept. 28, 1873. He had been a contributor to some of the smaller Parisian papers, when he leaped suddenly into fame with his story, *L'Affaire Lerouge* (1866), a novel having for its subject crime and detectives. He followed this with numerous stories of a similar character. Among them the more popular are *Le Crime d'Orcival* (1867); *La Dégringolade* (1876); and *La Vie Infernale* (1870).

**GABRIEL CHANNEL**, between Tierra del Fuego and Dawson's Island, is about 25 miles in length, and varies in width from two to three miles at the extremities to half a mile midway.

**GACHARD, LOUIS PROSPER**, a Franco-Belgian historian; born in Paris, March 12, 1800; died at Brussels, Dec. 24, 1885. He spent the greater part of his life as keeper of the archives at Brussels. He edited, from the national archives of Belgium and

Spain, the correspondence of William the Silent, Philip II, Margaret of Austria, and the Duke of Alva, and wrote *The Disturbances at Ghent under Charles V* (1846) and *The Retirement and Death of Charles V* (1855), besides other books dealing with the history of Belgium.

**GADE, NIELS WILHELM**, a Danish musical composer (1817-90). See BENNETT, SIR WILLIAM, Vol. III, p. 574.

**GADES.** See CADIZ, Vol. IV, p. 626.

**GAD-FLY**, a name usually applied to the true horse-fly (*Tabanus*), but sometimes to the bot-flies (*Æstrus*). See HORSE-FLY, in these Supplements.

**GADIDÆ.** See ICHTHYOLOGY, Vol. XII, p. 691; and COD, Vol. VI, pp. 103, 104.

**GADOW, HANS FRIEDRICH**, a German-British ornithologist; born in Cracow, Galicia, March 8, 1855; studied at Jena, Berlin and Heidelberg; attained such distinction in his native country that he was called to Cambridge University, England, to lecture on the morphology of vertebrata; was also appointed Strickland curator for the university. He published a number of treatises in British scientific journals and in the reports of the London Zoölogical Society. Volumes 8 and 9 of the British Museum *Catalogue of Birds* were edited by him, and on the anatomy of birds he became a recognized authority.

**GADSDEN**, a town and the capital of Etowah County, northeastern Alabama, on the Coosa River, and on the Gadsden and Attalla Union, the Louisville and Nashville and other railroads. Yellow pine lumber is here extensively manufactured, and in the vicinity coal and iron are found. Population 1890, 2,901; 1900, 4,282.

**GADSDEN, CHRISTOPHER**, an American patriot and Revolutionary general; born in Charleston, South Carolina, in 1724; died there, Aug. 28, 1805. He received his education in England. From 1741 to 1745 he was a clerk in a counting-house in Philadelphia, and then made a second visit to England. After his return to America he engaged in business on his own account and accumulated a small fortune. In 1765 he was a delegate to the first Colonial Congress, which adopted the Declaration of Rights, and in 1774 to the first Continental Congress. At the beginning of the Revolutionary War he entered the army as a colonel, and in September, 1776, was promoted to the rank of brigadier-general. For a time he was lieutenant-governor of South Carolina, and was a framer of the state constitution. He signed the capitulation when Charleston was taken by Sir Henry Clinton in 1780, and, refusing a parole, was imprisoned for 42 weeks. In 1782 he was elected governor of South Carolina, but declined the office, on account of his age.

**GADSDEN, JAMES**, an American soldier, grandson of the preceding; born in Charleston, South

Carolina, May 15, 1788; died there, Dec. 25, 1858. He served in the War of 1812 as lieutenant-colonel of engineers, and in 1818 in the Seminole campaign. In 1822 he retired from the army, and settled in Florida as a planter. In 1824 he became a member of the territorial council, was a commissioner to remove the Seminoles from northern to southern Florida, and in 1853 was made minister to Mexico. During his term of office in Mexico he negotiated for an extension of the Mexican boundary, and the purchase by the United States of what is known as the "Gadsden Purchase," including the present lands of Arizona and New Mexico.

**GADSDEN PURCHASE**, a name given to that portion of New Mexico and Arizona purchased from Mexico under a treaty negotiated by General James Gadsden for the United States, Dec. 30, 1853. The government paid \$10,000,000 for the territory, which comprised an area of 45,535 square miles. This land lies south of the Gila River.

**GADWALL** OR **GRAY DUCK** (*Chanletasurus streperus*), a bird of passage found in all countries of the northern hemisphere. It is highly prized as food.

**GAGE, LYMAN J.**, an American banker; born at De Ruyter, Madison County, New York, June 28, 1836. When he was ten years old his parents removed to Rome, N. Y. At the age of eighteen he entered the Oneida Central Bank as office-boy and general utility clerk. In October, 1855, he came to Chicago to seek his fortune. In August, 1858, he entered the service of the Merchants' Savings, Loan and Trust Company, and in 1861 was appointed cashier. At the



LYMAN J. GAGE

organization of the Bankers' Clearing-House he was elected manager. This appointment he declined, but filled the duties of manager until a suitable appointment could be made. In August, 1868, he accepted a proposal from the First National Bank of Chicago. In 1882, upon the reorganization of the First National Bank, he was elected vice-president, and subsequently president. He was the first president of the Bankers' Club, and in 1883 became president of the Commercial Club of Chicago. In 1883 he was chosen president of the American Bankers' Association, which office he held for three successive terms. His services in behalf of the Columbian World's Exposition were great, and he was elected president in May, 1890, but declined reelection in 1891. He was president from 1894 to 1895 of the Civic Federation, which labored assiduously for municipal reform in Chicago. In 1897 he was chosen Secretary of the Treasury by President William McKinley. See also **LAW AND ORDER SOCIETIES**, in these Supplements.

**GAGE, MATILDA (JOSLYN)**, American reformer; born in Cicero, New York, March 24, 1826; married, in 1845, to Henry H. Gage of Cicero; became well

known as an advocate of the abolition of slavery, and of woman suffrage. She edited the *National Citizen* from 1878 to 1881; and wrote *Woman as an Inventor* (1870); *The History of Woman Suffrage* (3 vols., 1881-86), in association with Susan B. Anthony and Elizabeth C. Stanton; and *Woman, Church, and State* (1893). Died at Chicago, March 18, 1898.

**GAGE, SIMON HENRY**, an American physiologist; born in Maryland, New York, May 20, 1851. He graduated from Cornell University, and, after a term of service as instructor, was appointed, in 1889, associate professor of physiology there. He has published *The Microscope and Histology* (1881), and, in connection with R. G. Wilder, *Anatomical Technology* (1882).

**GAGE, THOMAS**, an English missionary and author; born, according to some authorities, in Surrey, England, according to others, in Limerick, Ireland, about 1597; died in Kingston, Jamaica, in 1655. He was educated for the Roman Catholic priesthood in the order of the Dominicans in Spain. He went to Mexico with a party of friars, and was placed in charge of a wealthy parish, where he devoted himself to getting riches rather than to his ministry. When he had accumulated a large fortune he deserted his people, and after a roundabout journey through Central America, sailed from Costa Rica for England. There he renounced Catholicism and wrote an account of his adventures in Mexico and a description of the Spanish possessions. This account, entitled *English-American Description of the West Indies* (1648), attracted much comment and was translated into several languages. Until the time of its publication no information about Mexico and the West Indies had been permitted by Spain to be published. Desiring to secure some of the riches described in Gage's book, Cromwell fitted out an expedition against the West Indies, under Admirals Penn and Venables. This expedition captured the island of Jamaica, but gained no strong foothold. Gage accompanied the expedition in the capacity of guide.

**GAGERN, HEINRICH WILHELM AUGUST F.**, a German statesman; born at Bayreuth, Aug. 20, 1799. He was one of the founders of the student movement of 1815-19. After holding office under the government of Hesse-Darmstadt down to 1848, he became, in that year, one of the leading politicians of the Frankfurt parliament, of which he was elected president. He was a strong advocate of German unity, and was in favor of Prussia for the central state. In 1849 he resigned his position, and shortly after retired to private life. He engaged in politics again in 1859, this time against Prussia in the conflict with Austria. Pensioned in 1872, he died at Darmstadt, May 22, 1880.

**GAIKWAR'S DOMINIONS**. See **BARODA**, Vol. III, pp. 380, 381.

**GAIL, JEAN BAPTISTE**, a French Greek scholar; born in Paris, July 4, 1755; died there, Feb. 5, 1829. For twenty years he was professor of Greek literature in the College of France. From 1815 until his death he was curator of Greek and Latin manuscripts in the Royal Library. He was made a member of the Institute in 1809. He published editions

of *Theocritus* (1792); *Anacreon* (1793); *Xenophon* (1815); *Thucydides* (1807); and a *Greek Grammar*. (1798).—His son, JEAN FRANÇOIS GAIL, was born in Paris, Oct. 28, 1795; died there, April 22, 1845. He assisted his father for a number of years, and afterward became professor of Greek literature at the St. Cyr Military Academy. He published a number of works on Greek customs and several editions of the Greek writers. Among his publications are *Nature of Bacchus-Worship in Greece* (1821) and three volumes of *Geographi Græci Minores* (1831).

GAILLARD, EDWIN SAMUEL, an American physician; born in South Carolina, Jan. 16, 1827; died in Louisville, Kentucky, Feb. 1, 1885. He was graduated at the University of South Carolina in 1845, practiced in New York and Baltimore, and served in a professional capacity in the Confederate army. In 1865 he began practice in Richmond, Virginia, and established the *Richmond Medical Journal*. In 1868 he removed to Louisville, Kentucky, and continued the publication of the *Journal* there. He established the *American Medical Weekly* in 1874; became professor in the Medical College of Virginia, and afterward in the Louisville Medical College, of which he was the first dean.

GAINES, EDMUND PENDLETON, an American soldier; born in Culpeper County, Virginia, March 20, 1777; died in New Orleans, June 6, 1849. He entered the army in 1799, became major, then colonel, and in 1814 brigadier-general. The same year he was brevetted major-general for gallant conduct at Fort Erie, where he was severely wounded. He also received the thanks of Congress, with a gold medal. He was afterward active against the Seminoles in Florida, and in 1836 conducted an expedition against Osceola, in which he was again severely wounded. He was noted for simplicity and uprightness of character.

GAINES'S MILL, a hamlet in Virginia, in Hanover County, noted as the scene of a bloody battle between the Federal and the Confederate troops, during the efforts to capture Richmond by the former, under McClellan, June 27, 1862. This battle is known under the three names, Gaines's Mill, first Cold Harbor and Chickahominy. The Confederates were commanded by General Lee, and the Federal troops in the field were in command of General Fitz-John Porter. On the 26th of June the Confederate forces had been repulsed with great loss at the battle of Mechanicsville. The Federal troops, however, on account of heavy reinforcements to the Confederates, fell back six miles to a safer position on the Chickahominy, near Cold Harbor and Gaines' Mill. The next day a general engagement along the whole of the Federal line took place; but the brunt of the fighting was borne by Porter's division. All day the Confederate attacks were repulsed, but at dusk a final assault was made, which broke the center of the Federal line and caused the whole force to fall back across the Chickahominy and burn the bridges behind them. On account of this retreat, McClellan was forced to change his base of supplies to the James River. This was one of the "seven days" battles. The

loss to the Federals was about seven thousand killed and wounded, and to the Confederates something greater.

GAINESVILLE, a winter health-resort of Alachua County, northeastern Florida, and the capital of the county, on the Florida Central and Peninsular, the Florida Southern and other railroads. It contains a state normal school. It is in the fruit belt, growing oranges especially. It has several hotels for the accommodation of Northern visitors. Population 1890, 2,790; 1900, 3,633.

GAINESVILLE, a city and the capital of Hall County, northeastern Georgia, situated on the summit of the Chattahoochee Ridge, that divides the waters of the Gulf and the Atlantic. It is on the Southern and the Gainesville, Jefferson and Southern railroads, 50 miles N.E. of Atlanta. It has mills, machine-shops, car-shops, Gainesville College and Georgia Seminary; and its springs, which are chalybeate, limestone and freestone, make it popular as a health-resort. Population 1890, 3,202; 1900, 4,382.

GAINESVILLE, a city and the capital of Cooke County, northern Texas, eight miles S. of Red River and 62 miles N. of Fort Worth, on the Gulf, Colorado and Santa Fé and Missouri, Kansas and Texas railroads. It contains educational institutions, and the chief business of the people is stock-raising and grain and cotton growing. The manufactures are chiefly those of ice, brick, flour, castings, soap and brooms. Population 1890, 6,594; 1900, 7,874.

GAIRDNER, JAMES, a British historian; born in Edinburgh, March 22, 1828; attended lectures in the university there, and at 18, as a clerk, entered the Public Record Office in London, where he became assistant keeper in 1859. He distinguished himself by the rare combination of profound erudition, patient accuracy and judicial temper which he showed in the editing of a long series of historical documents. Among his publications are *Memorials of Henry VII* (1858); *Letters and Papers Illustrative of the Reigns of Richard III and Henry VII* (1863); *Gregory's Chronicle of London* (1876); and *Three Fifteenth-Century Chronicles* (1880).

GAIRDNER, WILLIAM TENNANT, a Scotch physician; born in Edinburgh, Nov. 8, 1824. He graduated M.D. at Edinburgh in 1845. He was appointed by the crown, in 1862, to the chair of practice of medicine in Glasgow University; was president of the Medical Association there in 1888, and physician in ordinary to the Queen for Scotland. He contributed many valuable papers to medical journals, and published important medical works, among which are *Clinical Medicine* (1862); *Public Health in Relation to Air and Water* (1862); *Medical Education, Character and Conduct* (1883); *Modern Views of Insanity* (1885); and *Lectures on Tabes Mesenterica* (1888).

GAISFORD, THOMAS, a British Greek scholar; born in Ilford, Wiltshire, England, Dec. 22, 1779; died at Oxford, June 2, 1855. He graduated from Christ Church, Oxford, in 1804. He was appointed professor of Greek literature at Oxford in 1811, and in 1831 became dean of Christ Church. He was a prolific and accurate writer. Among his works are, in addition to various editions of Greek authors,

*Poetae Graeci Minores* (4 vols., 1820-23); *Lexicon of Suidos* (1834); and *Etymologicon Magnum* (1848).

**GALANTHUS.** See SNOWDROP, Vol. XXII, p. 201.

**GALATEA.** See NEREUS, Vol. XVII, p. 346.

**GALAXY OR THE MILKY WAY.** See ASTRONOMY, Vol. II, p. 818.

**GALA WATER,** a stream of Edinburgh, Selkirk and Roxburgh shires, southeastern Scotland, rising among the Moorfoot Hills, and winding 21 miles S.S.E. past Stow and Galashiels, where, after a total descent of 800 feet, it falls into the Tweed, a little below Abbotsford and 2½ miles W. of Melrose. In its valley, the ancient Wedale, Skene locates the scene of one of Arthur's battles.

**GALE OR SWEET-GALE.** See GALEWORTS, in these Supplements.

**GALENA,** a city and the capital of Jo Daviess County, northwestern Illinois, situated on the Fevre River, six miles from its entrance into the Mississippi. By railroad it is 19 miles E.S.E. of Dubuque, and 133 W.N.W. of Chicago. Steamboats can ascend the river to Galena, which is about 100 miles by water above Davenport, Iowa. The principal exports are lead (mined and smelted in the vicinity), zinc, zinc ore, dairy products, grain and packing-house products. The town is beautifully situated on high bluffs, and is well laid out. It has good schools and a convent. Galena was for a long time the residence of ULYSSES S. GRANT; q.v., in these Supplements. Population 1890, 5,635; 1900, 5,005.

**GALENA,** a city of Cherokee County, Kansas, two miles from the eastern and six from the southern boundary of the state, on the Kansas City, Fort Scott and Memphis railroad. Large quantities of lead and zinc are mined here, and the city has stamping and smelting works. Population 1900, 10,155.

**GALENA ORE.** See LEAD, Vol. XIV, pp. 374, 375.

**GALEOPITHECIDÆ.** See MAMMALIA, Vol. XV, p. 401.

**GALERITES,** a genus of sea-urchins found as fossils in the chalk formations. The generic name, signifying a helmet, refers to the conical shape of the test, or shell. The mouth occupies the center of the lower surface; the vent is near the margin. They are related to the well-known "sand-dollars," and resembled them, except that the shells of *Galerites* were not of so disk-like a shape.

**GALERIUS.** See MAXIMINUS, Vol. XV, p. 644.

**GALES, JOSEPH,** an American journalist; born in England in 1760; died in Raleigh, North Carolina, Aug. 24, 1841. He published the *Register* in Sheffield, England, for several years, and in 1793 sold his journal and came to the United States. He then edited the *Philadelphia Independent Gazetteer*, in which he published the first stenographic reports of the Congressional proceedings. In 1799 he removed to Raleigh, North Carolina, and founded the *Register*, which he continued to publish until obliged to retire by age, when he turned his attention to African colonization, and until his death was a leader in the American organization.—His son, JOSEPH GALES, also a journalist, was born in Eckington, England, April 10, 1786; died in Washington, District of Columbia,

July 21, 1860. In 1807 he became connected with the *Washington National Intelligencer*, and in 1810 succeeded to the sole proprietorship. In 1812 he formed a partnership with William Winstone Seaton, and in 1813 the *Intelligencer*, which had previously been a triweekly paper, became a daily. Mr. Gales continued his connection with this journal until his death. The *Intelligencer* files form an important part of the authentic documents relating to United States history. Especially is this true of the Webster-Hayne debate record, published in full in its columns.

**GALESBURG,** a city of Knox County, northwestern Illinois, 53 miles W.N.W. of Peoria, 164 miles W.S.W. of Chicago, on four branches of the Chicago, Burlington and Quincy railroad. It is surrounded by fertile prairies, has a very large trade, and is noted for its educational institutions, among them Lombard (Universalist) University and Knox (Congregationalist) College. It has several foundries and machine-shops, and manufactories of brooms, corn-planters, carriages, etc. Coal is mined in the vicinity. Population 1890, 15,264; 1900, 18,607. See also Vol. X, p. 24.

**GALESVILLE,** the capital of Trempealeau County, Wisconsin, on Beaver Creek. It has Gale College, a flour-mill, stove-works and a barrel factory. Population, 1900, 862.

**GALEWORTS,** a name applied by some botanists to species of the family *Myricaceæ*, or sweet gales. They are resinous, often fragrant, shrubs, with small, naked flowers in catkins, and a small fruit commonly coated with wax. *Myrica Gale* is the sweet-gale of the northern bogs. *M. cerifera* is the bayberry, or wax myrtle, of the Atlantic coast, whose nuts are thickly incrustated with greenish or white wax; and *Comptonia asplenifolia* is the well-known sweet-fern of sterile soils, with sweet, aromatic fern-like leaves.

**GALIGNANI, JOHN ANTHONY AND WILLIAM,** two Parisian publishers; born in London; the former, Oct. 13, 1796; the latter, March 10, 1798. Their father was a native of Italy, and was the founder of an English library at Paris in 1800. He published there an English *Monthly Repertory*, and in 1814 founded the famous *Galignani's Messenger*. The sons continued the publication of the *Messenger*, and made it an important medium for advocating cordiality between England and France. They founded, at Corbeil, near Paris, a hospital for distressed Englishmen, and in 1889 the Galignani Home, for decrepit members of the printing and bookselling trades, was opened at Neuilly. The elder died Dec. 30, 1873, and the younger Dec. 12, 1882.

**GALILEE.** See ARCHITECTURE, Vol. II, p. 465.

**GALION,** a city of Crawford County, northern central Ohio, 64 miles N. of Columbus, on the New York, Lake Erie and Western and the Cleveland, Cincinnati, Chicago and St. Louis railroads. It has the railroad-shops of the New York, Lake Erie and Western railroad, foundries, and wheel and carriage factories. Grain is extensively raised in the neighborhood. Population 1890, 6,326; 1900, 7,282.

**GALIPOT,** a name given to the hardened turpentine which collects upon the stems of pine trees,

and which is, to some extent, an article of commerce in France.

GALLAGHER, WILLIAM DAVIS, an American poet and journalist; born in Philadelphia, Aug. 21, 1808. In 1830 he became editor of the *Xenia (Ohio) Backwoodsman*; in 1831, of the *Cincinnati Mirror*; in 1836, of the *Cincinnati Western Literary Journal and Monthly Review*; in 1838, of the *Hesperian*, a monthly miscellany of general literature, and at the same time was manager of the *Columbus (Ohio) State Journal*; and from 1839 to 1850 was connected with the *Cincinnati Gazette*. In the latter year he became the confidential clerk of Thomas Corwin, Secretary of the United States Treasury, and during the Civil War was again employed in the Treasury Department. At the close of the war he retired to Louisville. For a few years from 1854, Mr. Gallagher was an editor of the *Louisville Daily Courier*. He published three volumes of poems under the name of *Erato* (1835-37), and also *Selections from the Poetical Literature of the West* (1841); and *Miami Woods, A Golden Wedding, and Other Poems* (1881).

GALLAIT, LOUIS, a Belgian historical painter; born in Tournay, March 10, 1810; became famous by pictures on subjects from Dutch history, such as *The Abdication of Charles V* (1841); *Alva Viewing the Dead Bodies of Egmont and Horn* (1851); and *The Plague of Tournay* (1882), which last the Brussels Museum purchased for \$24,000. He also painted *Forgotten Sorrow* and *The Family of a Prisoner*. Some fine examples of his work are in the Walters Gallery, Baltimore. He was, perhaps, the leader in modern Belgian art. Died in Brussels, Nov. 20, 1887.

GALLA OX OR SANGA, a remarkable variety of ox inhabiting Abyssinia. The chief peculiarity of this animal is the extraordinary size of the horns, which rise from the forehead with an outward and then an inward curve, producing a figure of a lyre, and finally curve a little outward at the tip, to which they taper gradually.

GALLATIN, a city and the capital of Daviess County, northwestern Missouri, on Grand River, and on the Wabash and the Chicago, Rock Island and Pacific railroads, 55 miles by the former E.N.E. of St. Joseph. The vicinity furnishes lumber and agricultural advantages. Population 1000, 1,780.

GALLATIN, a town and the capital of Sumner County, central northern Tennessee, 26 miles N.E. of Nashville, on the Louisville and Nashville and the Chesapeake and Nashville railroads, and three miles N. of the Cumberland River. It contains cotton, woolen and carriage factories, flour-mills, a foundry and a manufactory of agricultural implements. Population 1890, 2,078; 1900, 2,409.

GALLATIN MOUNTAINS AND RIVER. See YELLOWSTONE NATIONAL PARK, Vol. XXIV, p. 737.

GALLAUDET, THOMAS HOPKINS, an American educator; born in Philadelphia, Dec. 10, 1787; died in Hartford, Connecticut, Sept. 9, 1851. He studied theology at Andover, and was licensed to preach in 1814, but after examining the methods in use at the establishments in Europe for teaching the deaf and dumb, devoted himself to the education of that class in the United States. He founded the first Ameri-

can institution for deaf mutes at Hartford, Connecticut, and was its president from 1817 to 1830, when he resigned because of impaired health. In 1838 he became chaplain of the Connecticut Insane Asylum. Among his works are *Sermons Preached to an English Congregation in Paris* (1818); *Bible Stories for the Young* (1850); and *Youth's Book of Natural Theology*. He edited, also, *American Annals of the Deaf and Dumb*. (See DEAF AND DUMB, Vol. VII, p. 11.)—His son, THOMAS GALLAUDET, born in Hartford, Connecticut, June 3, 1822, became a clergyman. In 1850 he was ordained deacon of the Protestant Episcopal Church, and the following year became priest. In 1852 he founded St. Ann's Church for Deaf Mutes, in New York City, and in 1885 the Gallaudet Home for Deaf Mutes, on the Hudson River, near Poughkeepsie. He contributed to the *American Annals of the Deaf and Dumb*, and to other periodicals.—Another son, EDWARD MINER GALLAUDET, born in Hartford, Feb. 5, 1837, followed in his father's footsteps, and in 1856 became a teacher in the Hartford Asylum for Deaf Mutes. In 1857 he organized the Columbian Institution for the Deaf, Dumb and Blind at Washington, District of Columbia, becoming its principal the same year. In 1864 he was made president of the National Deaf Mute College, and the following year professor of moral and political science. In 1880 he attended the international congress of instructors of deaf mutes, held at Milan, Italy, and in 1883 was president of the convention of American instructors at Jacksonville, Illinois. In 1886 he visited England on the invitation of the British government, and gave the royal commission on the education of the deaf, dumb and blind information regarding the system pursued by the United States. He was the author of a popular *Manual of International Law* (1879).

GALL-BLADDER. See DIGESTIVE ORGANS, Vol. VII, p. 231.

GALLE, JOHANN GOTTFRIED, a German astronomer; born at Pabsthaus, Germany, June 9, 1812. He studied at the universities of Wittenberg and Berlin, and afterward became a teacher at Guben and in Berlin. In 1835 he was made an assistant in the newly founded observatory in Berlin. Here he enjoyed the instruction of the celebrated astronomer, Encke. At the end of 1839 Galle discovered three new comets, for which he was awarded the Lalande prize. On Sept. 23, 1846, Galle received a letter from the French astronomer Leverrier, requesting him to examine a certain part of the sky for an unknown planet, and that very evening he discovered the planet Neptune (see ASTRONOMY, Vol. II, p. 813), marking an era in the history of astronomy. Galle continued to make further discoveries, and in 1851 was made professor of astronomy and director of the observatory at Breslau. He has published a number of articles on astronomy in several scientific journals, but especially in the *Astronomische Nachrichten*.

GALLENKA, ANTONIO CARLO NAPOLEON, an Italian historian; born at Parma, Italy, Nov. 4, 1810. He was educated at the University of Padua, and after a short literary career became involved in the



revolution of 1831, and was obliged to leave the country. After eight years spent in travel in France, the United States and other countries, he became a citizen of England in 1839. He was given the chair of Italian literature in University College, London, in 1843. He returned to Italy to participate in the revolution of 1848, was again obliged to flee, but returned to Italy in 1854, obtained favor, and was a member of the Piedmontese and Italian Parliaments from 1854 to 1864. He published, in 1854, a *History of Piedmont*, containing political statements which caused him trouble with the authorities. He also wrote *Italy, Past and Present* (1841-49); *The Blackgown Papers* (1845); *The Pope and the King* (1879); and *Italy, Present and Future* (1887). Died in Llandogo, Monmouth Co., Eng., Dec. 17, 1895.

**GALLEON**, a large ship formerly used by the Spaniards to carry home the gold, silver and other wealth contributed by the Mexicans and South American colonies. Galleons were armed, and had usually three or four decks, with bulwarks three or four feet thick, and stem and stern built up high, like castles. They were large, clumsy structures, and the easy prey of pirates and hostile navies.

**GALLEYS**. See **SHIP**, Vol. XXI, pp. 805-809.

**GALLI**, the priests of the goddess Cybele, or Agdistis, known in Rome as Rhea. See **CYBELE**, Vol. VI, p. 744; **PHRYGIA**, Vol. XVIII, p. 853.

**GALLICAN CHURCH**, the term applied to the Catholic Church in France, to distinguish the more or less independent attitude which it formerly occupied toward the Roman see. From the very foundation of the Western Empire the pope exercised a regulating power over civil as well as ecclesiastical affairs. Yet there was far less absolutism practiced in Gaul than in Rome. Constant struggles against the extension of papal power in France led to the pragmatic sanction of Saint Louis (see **FRANCE**, Vol. IX, p. 543), and brought on, in the time of Louis XIV, a convention, which resulted in the partial separation of the French or Gallican Church from the Church of Rome. The Church of France was never obliged to declare itself independent of papal rule, as the Church of England had done, but the beliefs upon which Bossuet and other Gallicans acted led to substantially the same doctrines as had directed the actions of the English bishops. The churches of France had been, from earliest times, designated as Gallican. In ancient times, in the rule of Louis IX, a liturgy had been adopted, which is known as the Gallican Liturgy. For a history of the later Gallican Church events, see **BOSSUET**, Vol. IV, p. 71; **CONCORDAT**, Vol. VI, p. 241; and **LITURGY**, Vol. XIV, p. 707.

**GALLIFET**, **GENERAL GASTON A. A.**, Marquis de, French Minister of War, was born in Paris Jan. 23, 1831. He entered the army in 1848, saw service in the Crimea and in Mexico, and in 1867 was given command of the 3rd Reg't of Chasseurs d'Afrique. During the second siege of Paris he commanded a brigade and showed much severity to the Communal prisoners. He subsequently served in Africa, and in 1875 was made a general. In 1887 he obtained the Grand Cross of the Legion of Honor. He has since acted as member of the

council of war and in June 1899, when the Waldeck-Rousseau ministry was formed, he was made minister of war. He has a European reputation as a distinguished cavalry officer and is an authority on cavalry manœuvres.

**GALL-INSECTS**. See **GALLS**, Vol. X, pp. 45, 46.

**GALLINULE**. See **MOOR-BEN**, Vol. XVI, p. 808.

**GALLIOT**, a Dutch vessel carrying a main and a mizzen mast, and a large gaff-mainsail. Galliot's of four hundred to five hundred tons burden were formerly used as bomb-vessels. This vessel is a direct modification of the ancient Roman galley, and at one time carried twenty oars.

**GALLIPOLIS**, a city and the capital of Gallia County, southeastern Ohio, on the Ohio River, midway between Cincinnati and Pittsburg, with which it is connected by a line of packet-boats. It is on the Columbus, Hocking Valley and Toledo and the Kanawha and Michigan railroads. The city contains foundries, woolen-mills, furniture factories, planing-mills, lumber-mills, leather-goods factories and a broom factory. Pop. 1890, 4,498; 1900, 5,432.

**GALLISONNIERE**, **AUGUSTIN FELIX ELIZABETH BARRIN**, **COUNT DE**, a French soldier; born in Anjou, France, in 1742. He served at first in the navy, but changed to the army, and so distinguished himself in the Hanoverian campaign as to be rewarded, in 1789, with the office of grand senechal of the sword, the highest position among the nobility. He was president of the Three Estates, and the leader of the nobility in the Constituent Assembly at the beginning of the Revolution. Although he took arms against the Revolutionists, he was active in Bonaparte's service in 1801. He retired from active service in 1815, at which time he held the rank of lieutenant-general. He died March 2, 1828.

**GALLITZIN**, **DEMETRIUS AUGUSTINE**, an American Roman Catholic missionary; born in The Hague, Holland, Dec. 22, 1770; died in Loretto, Cambria County, Pennsylvania, May 6, 1841. At the time of his birth his father was Russian ambassador to Holland, and was the head of one of the most influential of Russian families. His mother was a daughter of Frederick the Great's field-marshal, Schmettau. After serving a short time in the Austrian army, he was sent to America. Much against the will of his parents, in 1796 he was ordained a priest of the Roman Catholic Church at Baltimore, Maryland, and after traveling through various states of the Union as a missionary, settled in Cambria County, Pennsylvania, and purchased a large tract of land to be given to Roman Catholic families. He named his colony Loretto, and through his efforts the wilderness in which he settled was transformed into a thriving community.

**GALLIVATS**, large rowboats, formerly, and still to some degree, used on the Malabar coast. They rarely exceed seventy tons, carrying two masts with high triangular sails. The Malay pirates employ these swift but somewhat frail vessels.

**GALLON**, a unit of liquid measure. See **WATER**, Vol. XXIV, pp. 399, 400; **WEIGHTS AND MEASURES**, Vol. XXIV, pp. 505, 507, 517.

**GALT**, a city of Waterloo County, central southern Ontario, on the Grand River, and on the Canadian Pacific and the Grand Trunk railroads, 70 miles W.S.W. of Toronto. It is surrounded by a wealthy farming region; has large public schools and a collegiate institute; is supplied with city water, gas and electric lights. Flour and oatmeal mills, lumber-mills, and woolen and knitting factories are some of its industries; in the working of iron the city is one of the first in Ontario. The river supplies abundant water-power. Population 1891, 7,535.

**GALT**, SIR ALEXANDER TILLOCH, a Canadian statesman, was born in Chelsea, England, Sept. 6, 1817, and at an early age emigrated to Canada. In 1849 he was elected member for Sherbrooke, and from 1853 he sat in the Canadian Parliament till 1872, when he resigned. In 1858-62, in 1864-66, in 1867 and in 1869, he was Minister of Finance. In 1875 he was appointed a commissioner for Great Britain under the treaty of Washington of 1871, and more recently he acted as a member of the Halifax Fisheries Commission. From 1880 to 1883 he was High Commissioner for Canada in England; in 1881 was delegate for Canada at the Paris International Monetary Conference, and in 1883 a member of the Executive Committees of the International Fisheries Exhibition. He died in Montreal, Sept. 19, 1893.

**GALTON**, FRANCIS, an English explorer and anthropologist; born at Duddeston, Warwickshire, in 1822, a grandson of Erasmus Darwin, and cousin of Charles Darwin. He was educated in Birmingham and London, and graduated at Trinity College, Cambridge, in 1844. In 1846 he traveled in North Africa, and in 1850 explored lands in South Africa. Mr. Galton was author of *Meteorographica* (1863), the first attempt to chart the progress of the elements of the weather on a large scale, and through which the existence and theory of anti-cyclones was first established. In later years he published the following works, bearing more or less directly on heredity and on the measurement of the various faculties: *Hereditary Genius: Its Laws and Consequences* (1869); *English Men of Science: Their Nature and Nurture* (1874); *Inquiries into Human Faculty and its Development* (1883); *Natural Inheritance* (1889); *Finger-Prints and Hereditary Genius* (1892); *Deciphering of Blurred Finger-Prints* (1893); and several memoirs on composite portraiture.

**GALVA**, a city of Henry County, northwestern Illinois, 45 miles S. E. of Rock Island, on the ridge dividing the Illinois and Mississippi River basin. It is located in a rich coal region, on the Chicago, Burlington and Quincy and the Rock Island and Peoria railroads. It manufactures iron, pumps, agricultural tools, and brooms. Population 1890, 2,409; 1900, 2,682.

**GAVANIC BATTERY**. See ELECTRICITY, Vol. VIII, pp. 92, 93.

**GALVANIZED IRON**, plate iron coated with zinc, which renders it less liable to be affected by moisture and subject to corrosion. See IRON, Vol. XIII, pp. 357, 358.

**GALVANOMETER**. See ELECTRICITY, §§ 51-53, in these Supplements.

**GALVESTON**, a city and the capital of Galveston County, southeastern Texas, the most important port of the state. It has unexcelled transportation facilities. It has regular lines of steamers with New York, Morgan City, Indianola, and with Liverpool, Bremen, and other foreign ports. In manufacturing it has grown greatly. The 1890 census shows that the capital of its various manufactories amounted to \$5,100,000; that these employed 1,000 persons, paying \$1,200,000 wages to them, and that the value of the merchandise produced amounted to \$5,700,000. The most important industries are cotton presses, flour mills, cotton-seed oil mills, foundries, and iron works and breweries. The city is supplied with city water from an artesian well, and has gas and electric light plants. For its extensive shipping trade, Galveston has been largely aided by the National government in the construction of sea-walls, jetties, and wharves; but in spite of these the city is constantly exposed to the cyclones and tidal storms which periodically sweep across the gulf, and, dashing over the sea front of the city, do grievous injury to life and property. Disaster, in this respect, may almost be said to be invited, in consequence of the low-lying situation of the town (it is nowhere more than six feet above the sea-level), built on a narrow sand bar or spit of land that encloses Galveston bay and separates it from the Gulf of Mexico. Notwithstanding its drawbacks of situation, the city has become a great seaport and entrepot of the railways, and the chief cotton exporting point in the United States. It has also become a great depot for the shipping of lumber, hog and dairy products, eggs and poultry. The value of its inward and outward trade now amounts to close upon a hundred million dollars per year.

On September 8th and 9th, 1900, Galveston suffered a crowning disaster, the result of a destructive tornado and inundation by the waters of the Gulf, which swept over and submerged the city, causing a most calamitous loss of life and destruction of property. The appalling nature of the visitation may be gathered from the fact that over 3,000 lives are believed to have been lost, many of the citizens being either buried under their wrecked homes or drowned in the storm of waters that temporarily submerged the city. In many instances, entire families fell victims to the violence of the elements. The destruction to property has been estimated as not short of \$10,000,000. Devastating traces of the hurricane were also found throughout the State of Texas, but especially in the towns and villages adjacent to the Bay of Galveston and along the shores of the Gulf. The calamity evoked the greatest sympathy and aid of the entire nation, and thus gave heart to the stricken people of Galveston to enable them, as far as possible, to repair their terrible losses and address themselves to the task of rebuilding their city. Pop. (1890), 29,084; 1900 (before devastation of the city, in Sept. of that year), 37,789. See GALVESTON, Vol. X, p. 53.

GAMBETTA, LÉON, a French statesman; born in Cahors, France, April 3, 1838. After obtaining a collegiate education, he studied law in Paris, where he early became imbued with Republican doctrines and hatred of the Napoleonic system of suppression of liberal thought.

In 1869 he was elected to the Chamber of Deputies from the Paris district. In 1870, when the constant defeats of the French by the Prussians resulted in the abolition of the



LÉON GAMBETTA.

Napoleonic dynasty and the institution of the republic, Gambetta was made Minister of the Interior. He took charge of the troops in the field and did his utmost to stop the invasion. He refused to participate in the convention for the ratification of the peace treaty. From 1871 to 1875 he was busy in reorganizing the shattered Republican forces. As leader of the Republicans he forced the resignation of MacMahon in 1879, and in 1880 was elected president of the Chamber of Deputies. His great idea at this time was the substitution of the *scrutin de liste*, or vote by departments, for the *scrutin d'arrondissement*, or district-voting. In November, 1881, he was selected Premier and president of the Council. His ministry lasted but a few weeks, on account of the ultra-radical reforms proposed by himself. On Nov. 27, 1882, he died in Paris, his death being the result of an accident. He was at that time in the height of his power, and, in all probability, would have been the next President of the republic.

GAMBIER GUM. See LEATHER, Vol. XIV, p. 382.

GAMBIER ISLANDS. See TUAMOTO ARCHIPELAGO, Vol. XXIII, p. 602.

GAMBLING. See BETTING, Vol. III, pp. 618, 619; LOTTERIES, Vol. XV, p. 11; and WAGER, Vol. XXIV, pp. 305, 306. See ROUGE-ET-NOIR and ROULETTE, in these Supplements.

GAMBRELL, JAMES BARTON, an American clergyman and educator; born in Anderson County, South Carolina, Aug. 21, 1841. He graduated from the University of Mississippi, and served in the Confederate army during the whole of the Civil War. He entered the ministry of the Baptist Church in 1867, and held many important offices in that denomination, among them editor of *The Southern Baptist Record*. He was chosen president of Mercer University, Georgia, in 1893.

\*GAME-LAWS. Laws for the preservation of game, more or less adapted to the purpose for which they are intended, have been enacted in all the states and territories, with the exception of Mississippi. Broadly speaking, they are drawn with the object of preventing the killing or capture of game during the breeding season, and until such time as the young are sufficiently mature to secure their own living.

In a country so vast as the United States, the breeding seasons and conditions vary so widely that

a law which would be applicable to one locality would be entirely inappropriate to another. It is therefore obviously impossible that there could be any uniformity in legislation of this character throughout the country. So it has come about that the laws of one state bear no relation to those of another, each commonwealth having enacted for itself regulations to meet the requirements of its local conditions, without any reference to the laws of other states. It is therefore necessary for the sportsman who would keep within the pale of the law (as all true sportsmen wish to do), that before crossing the boundary of a state he should inform himself of the close seasons and other regulations regarding the killing of game that there exist, for in all probability they will widely differ from those of his own state.

It is an interesting fact, in relation to game-laws, that in nearly every state they have been enacted at the instance of dwellers in cities, their influence on legislation being brought to bear through the medium of gun-clubs, and other associations of like character. Up to the present time the preservation of game has been considered a matter of comparatively small importance, in the eyes of rural communities; indeed in some localities such laws are looked upon as being, more or less, an infringement of personal liberty, and the breaking of them considered, at most, a venial offense.

That the state has a right to regulate the time during which game may be killed and the manner of its killing, is undoubted. The argument used by certain agitators against game-laws, that when game is on land individually owned, it is the personal property of the land-owner, to do with as he will at all times and in all seasons, as he would with his chickens or his hogs, is entirely untenable. As legitimate would be the contention that a stream of running water passing through land is the personal property of the land-owner, to be diverted, dammed, or poisoned as might suit his particular purpose, without considering the right of those below him. The stream flows through the land of one to the land of another, and is the property of no individual, but of the people as a whole, and can be made use of by individuals only under certain restrictions. Game birds, fishes and quadrupeds pass likewise from place to place, and are the property of the community, and are therefore entirely proper objects for protection, so that they may be made of the greatest use to the greatest number.

It is a truism that no law can be successfully enforced unless the sentiment of the community is in favor of it; so it should be the duty of every true sportsman, by example and precept, to bring home to the people the great benefits that would result to the public, as a whole, were reasonable game-laws everywhere strictly enforced. The absence of such a sentiment has led to the practical extermination of that splendid game-bird, the prairie-chicken, in the Eastern states, and throughout the West, of that noble animal, the bison, which, within the memory of many men not now beyond middle age, roamed in countless thousands over the great trans-Missouri plains.

GAME - LAWS

TABLE OF CLOSE SEASONS.

STATE.	QUADRUPEDS.								BROS.				Pinnated Grouse (Prairie-Chicken)	
	Antelope	Bison.	Caribou.	Deer.	Elk.	Moose.	Moun- tain Goat.	Moun- tain Sheep.	Brant.	Duck.	Goose.	Pheasant		
Alabama.....													Until 1901.	
Arizona.....	1 Jan. 1 Sept.			1 Jan. 1 Sept.	Until 1898.		Until 1898.	Until 1898.						1 April 1 Sept. Until 1898.
Arkansas.....				1 Aug. 15 Oct.										
California.....	Prohib- ited. 1 Nov. 1 Aug.	Prohib- ited.		15 July. 1 Aug.	Prohib- ited. 1 Nov. 1 Aug.			Prohib- ited. Prohib- ited.	1 May 1 Sept.	15 Feb. 15 Oct. 1 May 1 Sept.	1 May 1 Sept.	Prohib- ited. Prohib- ited.		1 Nov. 15 Aug.
Connecticut.....				Until 1 Oct. 1903.					1 May 1 Sept.	1 May 1 Sept.	1 May 1 Sept.			
Delaware.....									1 Sept. 15 April 1 Oct.	1 Sept. 15 April 1 Oct.	1 Sept. 15 April 1 Oct.		31 Dec. 15 Nov.	1 Feb. 1 Sept.
District of Columbia.....									1 Sept.	1 Sept.	1 Sept.		Until 1900.	
Florida.....				1 March 1 Nov. 1 Jan. 1 Oct.										
Georgia.....				1 Jan. 1 Sept.	1 Jan. 1 Sept.	1 Jan. 1 Sept.	1 Jan. 1 Sept.	1 Jan. 1 Sept.		15 April 15 Aug.	15 April 15 Aug.		Until 1900.	15 Dec. 1 Aug. 1 Nov. 15 Sept.
Idaho.....	1 Jan. 1 Sept.		1 Jan. 1 Sept.	1 Jan. 1 Sept.	1 Jan. 1 Sept.	1 Jan. 1 Sept.	1 Jan. 1 Sept.	1 Jan. 1 Sept.		15 April 15 Sept.	15 April 15 Sept.			1 Feb. 1 Sept. 1 Dec. 1 Sept.
Illinois.....				1 Sept. 1 Jan. 1 Oct.					1 May 15 Aug.	1 Sept. 15 April 1 Sept.	1 May 15 Aug.			
Indiana.....				1 Oct. 1 Jan. 1 Sept.										
Iowa.....				1 Sept.										
Kansas.....														
Kentucky.....				1 March 1 Sept. 1 March 1 Oct.						1 April 15 Aug.	1 April 15 Aug.			
Louisiana.....				1 Jan. 1 Oct.		1 Jan. 1 Oct.				1 May 1 Sept.			Until 1901. 24 Dec. 15 Aug.	1 Jan. 1 Sept.
Maine.....			1 Jan. 1 Oct.	1 Jan. 1 Oct.		1 Jan. 1 Oct.								
Maryland.....														
Massachusetts.....										15 April 1 Sept.			Until 1901. 15 Aug.	1 Jan. 15 Sept.
Michigan.....				25 Nov. 1 Nov.						1 Jan. 1 Sept.	1 May 1 Sept.		Until 1898.	1 Nov. 1 Sept. 1 Nov. 1 Sept. 1 Jan. 1 Nov.
Minnesota.....			Jan., 1898.	20 Nov. 1 Nov. 1 Jan. 1 Oct.	Jan., 1898.	Jan., 1898.			15 April 1 Sept.	15 April 1 Sept.	15 April 1 Sept.			
Missouri.....				1 Oct.						1 April 1 Oct.				
Montana.....	15 Dec. 15 Sept. 1 Jan. 1 Oct.	Until 1903. 1 Jan. 1 Oct.		15 Dec. 15 Sept. 1 Jan. 1 Oct.	Until 1800. 1 Jan. 1 Oct.	Until 1899. 1 Sept.	15 Dec. 15 Sept.	15 Dec. 15 Sept.	1 Jan. 1 Sept.	1 Jan. 1 Sept.	1 Jan. 1 Sept.		Until 1903.	15 Nov. 15 Aug. 1 Jan. 1 Sept.
Nebraska.....				1 Oct.										
Nevada.....	1 Jan. 1 Sept.		1 Jan. 1 Sept.	1 Jan. 1 Sept.	1 Jan. 1 Sept.	1 Jan. 1 Sept.	1 Jan. 1 Sept.	1 Jan. 1 Sept.	1 April 15 Sept.	1 April 15 Sept.	1 April 15 Sept.			
New Hampshire.....				15 Nov. 15 Sept.		15 Nov. 15 Sept.								
New Jersey.....				5 Nov. 25 Oct.					1 May 1 Oct.	1 May 1 Oct.	1 May 1 Oct.		N. 10 Dec. 25 Oct. S. 1 Jan. 15 Nov.	
New Mexico.....	1 Jan. 1 Oct. 31 Oct. 10 Aug.			1 Jan. 1 Oct. 31 Oct. 16 Aug.	1 Jan. 1 Oct.	1 Jan. 1 Oct.	31 Oct. 10 Aug.						Until 1897.	
North Carolina.....				1 Oct.						30 April 1 Sept. 10 March 10 Nov.				
North Dakota.....	15 Dec. 1 Nov.	15 Dec. 1 Nov.	15 Dec. 1 Nov.	15 Dec. 1 Nov. 20 Nov. 15 Oct.	15 Dec. 1 Nov.				1 Dec. 1 Sept.	1 Dec. 1 Sept.	1 Dec. 1 Sept.			1 Dec. 1 Sept. 15 Dec. 1 Sept. 1 Feb. 1 Nov.
Ohio.....				15 Oct. Prohib- ited.						10 April 1 Sept.				
Oklahoma.....	Prohib- ited.			1 Dec. 1 Aug. 15 Dec. 1 Oct.	1 Dec. 1 Aug. 15 Dec. 1 Oct.	1 Dec. 1 Aug.								
Oregon.....								1 Dec. 1 Aug.		15 March 1 Sept.			1 Dec. 1 Sept.	1 Oct. 1 July. 1 Jan. 1 Oct. 1 Jan. 1 Nov.
Pennsylvania.....									1 May 1 Sept.	1 May 1 Sept.	1 May 1 Sept.			
Rhode Island.....										1 March 1 Sept.				
South Carolina.....				1 Feb. 1 Sept.									Until 1904.	
South Dakota.....	Prof b- ited.	Prohib- ited.		Prohib- ited.	Prohib- ited.					15 May 1 Sept.				1 Jan. 1 Sept.
Tennessee.....				1 Jan. 1 Aug. 20 Jan. 1 Aug.										
Texas.....				1 Sept. 1 Sept.	1 Sept. 1 Sept.									1 March 1 Aug. Prohib- ited.
Utah.....	6 Dec. 1 Sept.	6 Dec. 1 Sept.		6 Dec. 1 Sept.	1 Dec. 1 Sept.					6 Dec. 1 Sept.				Prohib- ited. Until 1900.
Vermont.....														
Virginia.....				1 Jan. 15 Aug.						1 May 1 Sept.				
Washington.....				1 Jan. 15 Aug.	1 Jan. 15 Aug.	1 Jan. 15 Aug.	1 Jan. 15 Aug.	1 Jan. 15 Aug.		1 April 15 Aug.				Prohib- ited.
West Virginia.....				15 Dec. 15 Sept.					1 April 1 Oct.	1 April 1 Oct.	1 April 1 Oct.			1 Jan. 1 Aug. 1 Nov. 1 Dec.
Wisconsin.....				21 Nov. 1 Nov.					1 May 1 Sept.	1 May 1 Sept.	1 May 1 Sept.		Until 1900.	20 Aug. 1 Nov. 15 Aug.
Wyoming.....	1 Dec. 1 Sept.	Until 1906.		1 Dec. 1 Sept.	1 Dec. 1 Sept.	1 Dec. 1 Sept.	1 Dec. 1 Sept.	1 Dec. 1 Sept.	1 Dec. 1 Sept.	1 Dec. 1 Sept.	1 Dec. 1 Sept.			

# GAME-LAWS

TABLE OF CLOSE SEASONS—CONTINUED.

STATE.	BIRDS.							FISH.					
	Plover.	Quail.	Ruffed Grouse.	Sage-Hen.	Snipe.	Swan.	Turkey.	Wood-cock.	Fish, generally.	Black Bass.	Gray-ling.	Salmon.	Trout.
Arizona		1 April 1 Sept.	1 April 1 Sept.				1 April 1 Sept.						1 Nov. 1 April.
Arkansas		1 March 1 Oct.					1 May 1 Sept.						
California		15 Feb. 15 Oct.	15 Feb. 15 Aug.							1 Jan. 1 July.		31 Aug. 1 Nov.	1 Nov. 1 April. 1 Dec.
Colorado		Prohibited.	1 Nov. 15 Aug.	1 Nov. 15 Aug.		1 May 1 Sept.	1 Nov. 15 Aug.						1 Dec. 1 June. 1 July 1 April.
Connecticut		1 Jan. 1 Oct.	1 Jan. 1 Oct.					1 Jan. 1 Oct.		1 May 1 July.			
Delaware		31 Dec. 15 Nov.	31 Dec. 15 Nov.			15 April 1 Oct.							
District of Columbia	1 May 1 Sept.	1 Feb. 1 Nov.	1 Feb. 1 Aug.		1 May 1 Sept.			1 Feb. 1 July.					
Florida		15 M'rch 1 Nov.					15 M'rch 1 Nov.						
Georgia		1 April 1 Oct.	1 April 1 Oct.		1 April 1 Oct.		1 April 1 Oct.						
Idaho		1 Dec. 1 Oct.	15 Dec. 1 Aug.	15 Dec. 1 Aug.		15 April 15 Aug.							
Illinois		1 Dec. 1 Oct.	1 Dec. 1 Oct.				15 Jan. 1 Sept.	15 Sept. 15 July.					
Indiana		1 Jan. 10 Nov.	1 Jan. 10 Nov.				1 Feb. 1 Nov.	1 Jan. 1 July.	Lake Fish. 1 April 15 June.				
Iowa		1 Jan. 1 Oct.	1 Jan. 1 Oct.				1 Jan. 1 Oct.	1 Jan. 10 July.		1 April 15 May. 1 July.			1 Nov. 1 April.
Kansas													
Kentucky		1 Jan. 15 Nov.	1 Jan. 15 Nov.				1 Feb. 1 Sept.	1 Feb. 20 June.					
Louisiana		1 April 1 Oct.	1 April 1 Oct.				15 April 1 Oct.						
Maine	1 May 1 Aug.	1 Dec. 1 Oct.	1 Dec. 20 Sept.					1 Dec. 1 Sept. 24 Dec. 15 June.		10 April 1 July.		15 Sept. 1 April.	1 Oct. 1 May. 15 Aug. 1 April.
Maryland		24 Dec. 1 Nov.											1 Sept. 1 April.
Massachusetts	1 May 15 July.	1 Jan. 15 Oct.	1 Jan. 15 Dec.		1 May 15 July.					1 Dec. 1 June.		1 Aug. 1 May.	1 Sept. 1 April.
Michigan		15 Dec. 1 Nov.	15 Dec. 1 Nov.		15 Dec. 1 Nov.		15 Dec. 1 Nov.	15 Dec. 15 Aug.			1 Sept. 1 May.		1 Sept. 1 May.
Minnesota	31 Oct. 4 July.	1 Dec. 1 Sept.	1 Dec. 1 Sept.		15 April 1 Sept.			31 Oct. 4 July.	1 March 1 May.				1 Sept. 1 May.
Missouri	1 Jan. 1 Aug.	1 Jan. 1 Nov.	1 Jan. 1 Nov.				1 Jan. 1 Nov.	1 Jan. 1 Aug.					
Montana		Until 1003.	15 Nov. 15 Aug.	15 Nov. 15 Aug.	15 Nov. 15 Aug.	1 Jan. 1 Sept.							1 May. 1 July.
Nebraska		1 Jan. 1 Oct.					1 Jan. 1 Oct.						
Nevada	1 April 15 Sept.	15 M'rch 15 Sept.	15 M'rch 15 Sept.	1 March 15 July.	1 April 15 Sept.	1 April 15 Sept.		15 M'rch 15 Sept. 1 Jan.					1 Oct. 1 June. 1 Sept.
New Hampshire	1 Feb. 1 Aug.	1 Jan. 15 Sept.	1 Jan. 15 Sept.					15 Sept. N 10 Dec.		1 May 15 June.		30 Sept. 15 April.	1 May.
New Jersey	15 Dec. 1 Nov.	25 Oct. S. 1 Jan.	25 Oct. S. 1 Jan.		15 Dec. 31 Aug.			25 Oct. S. 1 Jan. 15 Nov.		1 Dec. 30 May.			15 July 1 April.
New Mexico		1 March 1 Oct.					1 March 1 Oct.						1 Nov. 1 May.
New York	1 May 1 Sept.	31 Dec. 1 Nov.	31 Dec. 16 Aug.		1 May 1 Sept.			31 Dec. 16 Aug.		31 Dec. 30 May.		15 Aug. 1 March.	31 Aug. 16 April. 16 Oct. 30 Dec.
North Carolina		15 Mch. 1 Nov.	15 M'rch 1 Nov.				15 M'rch 1 Nov.						
North Dakota	1 Dec. 1 Sept.		1 Dec. 1 Sept.					1 Dec. 1 Sept.		1 Nov. 1 May.			
Ohio		15 Dec. 10 Nov.	15 Dec. 1 Sept.				15 Dec. 1 Oct.	15 Dec. 1 Nov. 15 July.				15 Sept. 14 M'rch	15 Sept. 14 M'rch
Oklahoma	1 Jan. 1 Aug.	1 Feb. 1 Nov.	1 Feb. 1 Nov.				1 Feb. 1 Nov.						
Oregon		1 Sept. 1 Oct.	1 Sept. 1 Oct.			15 M'rch 1 Sept.							1 Nov. 1 April.
Pennsylvania	1 Jan. 15 July.	15 Dec. 1 Nov.	1 Jan. 1 Oct.				1 Jan. 15 Oct.	1 Jan. 4 July.		1 Jan. 1 June.		15 Aug. 1 March.	15 July. 15 April. 15 July 1 April.
Rhode Island	1 April 1 Aug.	1 Jan. 1 Oct.	1 Jan. 1 Sept.					1 Jan. 1 Sept. 1 Nov.					
South Carolina		1 April 1 Nov.	1 April 1 Nov.				1 April 1 Nov.						
South Dakota	15 May 1 Sept.	Prohibited.	1 Jan. 1 Sept.		15 May 1 Sept.					1 Oct. 1 May.			1 Oct. 1 May.
Tennessee		1 March 1 Nov.											
Texas		1 April 1 Oct.					15 May 1 Sept.						
Utah		15 M'rch 1 Sept.	15 M'rch 1 Sept.	15 M'rch 15 Aug.	1 April 1 Oct.								15 Feb. 15 June. 1 Sept.
Vermont	1 Jan. 1 Sept.	1 Jan. 1 Sept.	1 Jan. 1 Sept.					1 Jan. 15 Sept. 1 April 1 Nov.		1 Jan. 15 June. 15 May 1 July.			1 May. 15 Sept. 1 April.
Virginia		1 Jan. 15 Oct.	1 Feb. 15 Sept.				1 Feb. 15 Sept.						
Washington		Prohibited.	1 Jan. 1 Aug.	1 Jan. 1 Aug.		1 April 15 Aug.						1 March 10 April. 10 Aug. 10 Sept. 1 April 15 June.	1 Nov. 1 April.
West Virginia		20 Dec. 1 Nov.	1 Jan. 1 Dec.				1 Jan. 15 Sept.	15 Sept. 1 July. 1 Dec. 20 Aug.		1 March 1 June.			1 Sept. 1 Jan. 20 Aug. 15 April.
Wisconsin		20 Aug. Prohibited.	1 Nov. 15 Aug.	15 Oct. 1 Aug.		1 May 1 Sept.							1 Nov. June 1.

The loss to the nation by the wanton destruction of the bison is almost incalculable. Not only has a vast source of food-supply and valuable hides been swept away, but the opportunity for indulging in one of the most delightful, healthy and manly sports is denied this and all future generations. The people, as a whole, were ruthlessly robbed, by a handful of ignominious "pot-hunters" for their own sordid ends.

But above and beyond the purely economic advisability of preventing the extermination of wild food-animals, there are certain broad moral and patriotic reasons for their preservation, which should be accorded due weight.

The pursuit of game, more than any other form of amusement, inures its votaries to toil and hardship, quickens the perceptions, steadies the nerves and sharpens the powers of observation. It cannot be doubted, that the larger the number of such men a nation possesses, the better fitted it is to meet and repel attack. Where such a class exists, there is ready at hand a body of men, self-reliant by habit, athletic, hardened by exposure and accustomed to the handling of firearms, from which at once to recruit soldiers of the best quality. Too much weight cannot be given to this circumstance, particularly by a country like the United States, which has a comparatively small standing army to depend upon in time of need.

To-day, because of the practical disappearance of big game in the Eastern states, a general knowledge of the use of the rifle, which stood the country in such good stead in Revolutionary days, is a thing of the past in that section. In the central states, as deer and turkey are becoming scarce, a similar condition is fast approaching; and even in the far West, as big game is being thinned out and driven to the more inaccessible regions, that weapon is being daily less and less used. It depends upon the enactment and enforcement of intelligently framed laws for the preservation of game whether or not the shot-gun is in its turn, also, to fall into disuse, and the race of hardy sportsmen, so valuable to the country, to disappear. In short, the subject of game-preservation and game-laws is far from being (as it is too often considered) one merely of moment to a self-interested clique of sportsmen, but, on the contrary, is a matter of vast national concern, worthy the deepest consideration of all patriotic legislators.

On pages 1363, 1364 is a tabulated statement of the close seasons for the principal game birds, beasts and fishes throughout the United States. In many states there are numerous local regulations, regarding which it would be well for the sportsman to inquire into, but which it is unnecessary to here set forth. Attention is called to some of the more important, particularized below. It may here be stated that in almost all states there are regulations prohibiting the exportation of game from the state, and in many states the shooting of wild-fowl between sunset and sunrise is not allowed.

*California.* The quail referred to are those that are locally known as the valley quail. The close season for mountain-quail is February 15th to August 15th.

*Florida.* In many counties there are special laws modifying the period of close season.

*Idaho.* Killing of all quadrupeds mentioned, excepting deer and antelope, prohibited until after Sept. 1, 1897. Thereafter, close season as indicated.

*Indian Territory.* The United States Statutes of 1878, section 2137, provides that every person, other than an Indian, who, within the limits of any tribe with whom the United States has existing treaties, hunts, etc., any game, except for subsistence, shall forfeit all guns, etc., and be liable to fine of \$500.

*Maine.* Many local laws modify close seasons.

*Maryland.* There are so many local laws that the quotation of the close season under state statutes is apt to be misleading. The reader is therefore specially warned.

*Michigan.* The close season for ruffed grouse in the *Upper Peninsula* is January 1st to October 1st.

*Mississippi.* No state law.

*New Jersey.* There are two sets of laws, one referring to the northern and another to the southern part of the state; hence the statement of two distinct close seasons, in some instances.

*New York.* In certain counties the killing of quail is prohibited until 1898.

*North Carolina.* Numerous county regulations modifying state law.

*Oregon.* Special prohibition from killing any pheasant or quail east of the Cascade Mountains.

*Tennessee.* Special county regulations regarding the close season for deer and turkey.

*Virginia.* Many special county regulations.

HENRY F. GRIERSON.

GAMETE, a name given to the sexual cells of plants. In the lower plants (certain algæ and fungi), the two gametes which unite in the sexual act are similar; but in most of the higher plants the gametes become differentiated into male and female, the former (spermatozoids or antherozoids) being very small and active, the latter (oöspheres) being relatively very large and passive. In the seed-plants the oösphere retains its character, but the male gamete becomes adapted to transfer by the pollen-tube.

GAMETOPHYTE, the name given to that phase in the life-history of plants which produces the gametes, or sexual cells. It is usually applied only to the plants above thallophytes, in which alternation of generations becomes distinct. In such cases the gametophyte, bearing the sex-organs, is quite distinct from the sporophyte, bearing the asexual spores, the two alternately producing each other. In moss-plants the gametophyte is the leafy phase, and hence the most conspicuous; in the fern-plants it is much reduced, the sporophyte having become the leafy phase, but it is quite independent; while in the seed-plants it becomes so much reduced as to be parasitic upon the large sporophyte, and its presence is very much concealed. See ALTERNATION OF GENERATIONS and MORPHOLOGY, in these Supplements.

GAMING, the act of two or more parties in playing games of chance for money or other thing of value, whereby one shall lose and the other gain. Governed by the same rules is betting upon the result of some game, act or event in which the parties laying the bet may not be actually participating. In many of the states of the United States, gaming, as well as most other forms of gambling, is prohibited by statute, especially in public places. The keeping of public gaming-houses is also prohibited in most states, and is made punishable by

fine or imprisonment, or both; it is also indictable at common law. Gambling contracts are, as a rule, void. Contracts concerning board of trade and stock speculations have often been held to be gambling contracts. Statutes forbidding gambling and the keeping of gambling-houses are constitutional. See GAMES, GAMING, Vol. X, pp. 66-67.

**GAMMARUS**, a genus of amphipod crustaceans, consisting of marine and fresh-water species; often called beach fleas and sandhoppers, but these terms are commonly applied to all amphipods. They are abundant, and important in the food supply of fishes.

**GAMTOOS**. See CAMTOOS, these Supplements.

**GAMUT**, the diatonic scale. Figuratively, the whole range; as the entire *gamut* of experience.

**GANGLIA**. See ANATOMY, Vol. I, pp. 867-79; and PHYSIOLOGY, Vol. XIX, pp. 23-43.

**GANGRENE**. See MORTIFICATION, Vol. XVI.

**GANNETT**, EZRA STILES, an American Unitarian clergyman, born May 4, 1801, in Cambridge, Mass. In 1824 he was chosen assistant to William Ellery Channing, in Boston, whom in 1842 he succeeded in the pastorate. He edited the *Christian Examiner*, 1844-49. Died near Boston, Mass., Aug. 28, 1871.

**GANNETT**, HENRY, an American topographer; born in Bath, Maine, Aug. 24, 1846. After graduating at Harvard College and the Lawrence Scientific School, he remained at Harvard as assistant in the observatory (1870-71). He entered the government service in 1872, and was appointed chief topographer of the Geological Survey in 1882. His most important publication is his *Dictionary of Altitudes* (1891). He was a contributor to this ENCYCLOPÆDIA.

**GANNETT**, WILLIAM CHANNING, an American Unitarian clergyman, son of Ezra Stiles Gannett; born in Boston, Mass. March 13, 1840. After graduation from Harvard in 1860, he entered the Unitarian ministry, and held pastorates at various points in the East and Northwest. He published a *Biography of Ezra Stiles Gannett* (1875); *A Year of Miracle* (1881); and, in junction with Jenkin Lloyd Jones, *The Faith That Makes Faithful* (1888).

**GANOIDS**. See ICHTHYOLOGY, Vol. XII, p. 634.

**GARCIA Y INIGUEZ**, CALIXTO, a Cuban revolutionary leader; born at Holguin, Santiago province, Cuba, Oct. 14, 1836. He was by profession a lawyer.

In 1868, at the beginning of the "Ten Years' War," he gave up his extensive plantations and joined the revolt against Spanish rule, which had been begun by Céspedes on October 10 of that year. The insurrection had been carried on with varying success, when, on Sept. 3, 1873, Garcia,

with 20 men, was surprised by 400 Spanish troops. After fighting vainly against these odds, Garcia, preferring death to surrender, placed his pistol beneath his chin, fired upward, and fell unconscious. The Spaniards carried his body to Manzanillo, where he revived and finally recovered. The bullet had passed through his mouth and emerged from his forehead, leaving a scar which

he carried to his grave. His life was spared by the Spanish government, but he was imprisoned at Valencia and Santoña, in Spain. On the conclusion of the peace of Zanjon in 1878, Garcia, at the request of General Campos, was liberated, and he went to New York. In August, 1879, with a few followers, he returned to Cuba and began the "Little War," but was defeated and again taken prisoner. His life was again spared, and he was taken to Madrid, where for the next sixteen years he lived under police supervision, supporting his family, consisting of wife and six children, by teaching French and English. In September, 1895, revolution having again broken out in Cuba, he left Madrid secretly, and made his way to Paris and thence to New York, where he arrived in November. He at once organized a filibustering expedition, which, however, came to grief; and, while fitting out another, he was arrested by the United States government and compelled to give bail in \$2,500. Before the date fixed for his trial, however, he, in March, 1896, sailed on the *Bermuda* and landed near Baracoa, in Cuba, where he issued a bombastic proclamation. During the ensuing irregular warfare Garcia's principal feat of arms was the capture of Guaimaro, in December, 1896. During the siege of Santiago by the United States troops in June and July, 1898, Garcia, with his band of insurgents, cooperated with General Shafter, and when the city surrendered he was incensed because he was not placed in its command, and on General Shafter's refusal he withdrew to Holguin, July 17. He returned, however, on September 23, and was enthusiastically received by the inhabitants. In December, 1898, he was appointed the head of a commission elected by the Cuban assembly which met at Santa Cruz del Sur, to visit Washington and discuss with President McKinley the question of the future of Cuba. There, in consequence, no doubt, of the sudden change of climate, he was attacked by pneumonia, and died Dec. 11, 1898.

**GARCIN DE TASSY**, JOSEPH HÉLÉODORE SAGESSE VERTU, a French Orientalist; born at Marseilles, Jan. 20, 1794; died in Paris, Sept. 2, 1878; studied Oriental languages under Silvestre de Sacy; was appointed professor in the Institute in 1838; published *Peculiarities of the Mussulman Religion in India* (1832); *History of Hindu and Hindustani Literature* (1837); *Philosophic and Religious Poetry Among the Persians* (1864); and *Rhetoric and Prosody of the Languages of the Mussulman of the Orient* (1873).

**GARDEN**, ALEXANDER, a British naturalist, born in Edinburgh about 1730; died in London, April 15, 1791. In 1752 he began the practice of medicine in Charleston, S. C., and in 1754 he became a professor in King's (now Columbia) College; in 1773 a member of the Royal Society of London; and later vice-president. He adhered to the royal cause in the Revolution, and went to England in 1783. His property in South Carolina was confiscated, but afterward was restored to his son. He published numerous works on botanical and zoölogical subjects. The botanical genus *Gardenia* was named by Linnaeus after him.

**GARDEN CITY**, capital of Finney Co., Kansas;



CALIXTO GARCIA.

has a United States land-office and a system of water-works; manufactures flour and brooms; ships cattle and produce; is the center of the irrigation-works of southwestern Kansas. Population 1900, 1,590.

GARDEN CITY, a village of Queens Co., Long Island, N. Y., about 18 miles E. of New York city; founded by A. T. Stewart; is the seat of the Protestant Episcopal bishop of Long Island. The Memorial Cathedral of the Incarnation (Protestant Episcopal) is a fine example of Gothic architecture, and the Memorial School (St. Paul's), for boys, among the most complete school institutions in the country. There is also a female seminary. Each of the ecclesiastical buildings is surrounded by an extensive park of its own.

GARDENIA, a genus of Oriental plants belonging to the family *Rubiaceæ*, or madders. They are shrubs or small trees, with bright green leaves, large and showy, usually very fragrant flowers, and large berries. *G. florida*, the Cape jasmine, from China, is a favorite exotic house-plant, with white flowers and orange-colored berries.

GARDINER, a city of Kennebec Co., Maine, on the Cobsossa river, at its junction with the Kennebec, and on the Maine Central railroad, 12 miles below Augusta. The Cobsossa supplies abundant power, having a fall of 130 feet in the last mile of its course. The city manufactures lumber, paper, furniture, sashes, shoes, wool, castings, and machinery, and does a very large ice business, supplied from the Kennebec. It has a public library, water-works, and an electric-lighting plant. Population 1890, 5,491; 1900, 5,501.

GARDINER, SAMUEL RAWSON, an English historian, chiefly of the period of the Civil War and the times of the first two Stuart kings; born at Ropley, Hampshire, March 4, 1829, and educated at Winchester and Christ Church, Oxford, from which he graduated in 1851. For some time he held the professorship of modern history at King's College, London, but resigned it in 1885, when elected fellow of All Souls', Oxford, that he might pursue more freely his historical studies. Here he devoted himself with great industry and ardor to the preparation of the series of works which elaborately treat of the era of the Civil War and Commonwealth, and to the editing, for the Camden Society, of miscellaneous political documents, family papers, and Parliamentary debates, which throw much historical light on the period. In 1882 a civil-list pension was granted to him by the crown, in recognition of his valuable contributions to the history of England; and in 1894, on the death of the historian Froude, he was appointed regius professor of modern history at Oxford. His *History of the Great Civil War* (3 vols., 1886-91) is distinguished by a masterly grasp of facts and impartial and sober judgments. He also published a *History of England from 1603 to 1642* (10 vols., 1883-84), which embraces the substance of several earlier works dealing with the periods of James I and Charles I. His other works are *The Thirty Years' War* (1874); *The First Two Stuarts and the Puritan Revolution* (1875), both issued in the Epochs of Modern History series; and *A Student's History of England, from the Earliest Times to*

1885 (1890). In 1890 he edited, for the Clarendon Press, the *Constitutional Documents of the Puritan Revolution*, with an admirable introduction, a work which forms a useful companion to Bishop Stubbs's *Select Charters*. He has also published two volumes of a *History of the Commonwealth and Protectorate* (1894, 1897); *Cromwell's Place in History* (1897); and *What Gunpowder Plot Was* (1897). In conjunction with J. Bass Mullinger, he wrote, in 1881, an *Introduction to the Study of English History*, with authorities. —His wife, BERTHA MERITON GARDINER, published, in Longman's Epochs of Modern History series, a meritorious manual on *The French Revolution*.

GARDINER'S ISLAND, east of Long Island, belongs to Suffolk Co., N. Y.; area, 3,300 acres. Its surface is undulating pasture land. Here treasures were dug up, reputed to have been buried by Captain Kidd in 1699. There is a lighthouse at the northern end, lat.  $41^{\circ} 8' 18''$  N., long.  $72^{\circ} 8' 13''$  W., with a fixed light 30 feet above sea-level.

GARDINI, MADAME ETELKA GERSTER, vocalist; born at Kaschau, Hungary, June 16, 1857. The director of the Conservatory of Music at Vienna happened to hear her sing once in a religious procession, and advised her to study vocal music under Madame Marchesi. Gerster profited by her instruction for three years. On Jan. 8, 1876, she made her *début* at Venice, in *Rigoletto*, with wonderful success. After this she took up the parts of Ophelia, Lucia, Amina, and Marguerite. In March, 1877, she appeared in Berlin, where she met with unexampled success. In St. Petersburg and Moscow she sang before the Tsar and Tsaritsa, and received special favors from the latter. She appeared in London in 1877-80; and in 1878 and 1880-83, sang in the United States, where she was much applauded. Her voice was a pure soprano. Gerster was married to Pietro Gardini in May, 1877.



ETELKA GERSTER.

GARDNER, a village of Worcester Co., Mass., a flourishing manufacturing center on the Otter river and on several branches of the Fitchburg railroad. Two hundred different varieties of chairs are manufactured here, giving employment to 2,000 men, the annual product being valued at over \$2,000,000. Population 1890, 8,424; 1900, 10,813.

GARDNER, AUGUSTUS KINSLEY, an American physician; born in Roxbury, Mass., July 13, 1812; graduated at Harvard in 1844. After three years spent in European study, he began the practice of his profession in New York city. He was extraordinarily successful, especially in the treatment of the diseases of women and children. He published *A Medical Student in Paris* (1848), and *Causes and Treatment of Sterility* (1850). He was a pronounced humanitarian. New York owes to him many of its public drinking-fountains, and his efforts in importing and domesticating insect-eating birds were of incalculable benefit to the city and the state. Died in New York, April 7, 1876.

GARDNER, CHARLES K., an American soldier;



born, in 1787, in Morris County, New Jersey. He joined the United States army in 1808; served in the War of 1812; was promoted lieutenant-colonel in 1815, and adjutant-general of the northern division of the army in 1817. He was assistant postmaster-general under Jackson, auditor of the Post-Office Department under Van Buren, and postmaster at Washington under Polk. He published a *Dictionary of Commissioned Officers in the United States Army from 1789 to 1853* (1853). He died in Washington, District of Columbia, Nov. 1, 1869.

GARDNER, GEORGE, a British botanist; born in Glasgow, Scotland, in May, 1812. He spent five years, beginning with 1836, in travel in Brazil. He explored the principal streams of that country, and made an excellent collection of the flora of the region, securing many new species. He went to Ceylon in 1844 as superintendent of the Botanical Gardens. He published, in 1846, *Travels in the Interior of Brazil*, and numerous pamphlets. He died in Ceylon, at Neura Ellia, March 10, 1849.

GARFIELD, JAMES ABRAM, an American statesman, twentieth President of the United States;



JAMES A. GARFIELD.

born in Orange, Cuyahoga County, Ohio, Nov. 19, 1831. His father died when he was a child, and he was obliged, as soon as he was able, to assist his mother in the support of the family in the log-cabin home. He received his early schooling during the winter terms of the district school. But he gained much more knowledge from his constant reading. He worked his way as a carpenter through

the Chester (Ohio) Seminary. The year before (1848) he had worked as tow-boy on the Ohio canal. In 1851 he entered Hiram College, Ohio, which, at the time, was the principal Western educational institution of the Campbellite Church, to which the Garfields belonged. Here he remained three years, during which time he supported himself by giving instruction in some of the preparatory classes. He entered the junior class of Williams College, Massachusetts, in 1854, and graduated in 1856. He returned to Hiram College as teacher of Latin and Greek, and in 1857 became the president of the institution. While exercising the duties of his office he studied law and began to take an interest in politics, lending his support to John C. Frémont. He was elected state senator in 1859, and in 1861, when the Civil War began, organized a regiment from among his students and was assigned to duty at the head of a brigade in Kentucky. He was ordered by General Buell to expel the Confederates under Marshall from Kentucky. He ended a successful campaign by the decisive battle of Middle Creek, Jan. 10, 1862, where, with 1,100 men, he defeated an army of 5,000. For this victory he was commissioned a brigadier-general by Lincoln, and as such took part in the second day's fighting at

Shiloh. He was engaged in the siege of Corinth, but while directing some of the engineering operations was taken sick and sent home, July 30, 1862. Two months later he reported at Washington and was assigned to court-martial duty. The most important case tried by him was that of General Fitz-John Porter. In 1863 he returned to the army of the Cumberland and was appointed chief of staff by General Rosecrans. He distinguished himself at the battle of Chickamauga, and for his services was made major-general. He was at this time elected to Congress from the nineteenth district of Ohio. He now began a legislative career equally as brilliant as his military record. He was a prominent member of the committee on military affairs; chairman of the committee on banking and currency, and of the appropriations committee; was a member of the electoral commission in 1877, and that year was elected a Senator. He was nominated for the Presidency of the United States at the Republican convention in Chicago, June, 1880, and elected after a hard contest. He had been in office but four months when, July 2, 1881, he was shot by a half-crazed assassin, Charles J. Guiteau, in the Baltimore and Potomac depot at Washington. He lingered until September 19th. He was buried in Cleveland, Ohio, September 26th. Monuments have been erected to his memory in different states.

Although successful in every line of life, he gained his positions only by hard struggles, and in some cases sharp fighting against acrimonious opposition. His reputation was attacked in the *Crédit Mobilier* scandal, his sincerity often questioned, and his power denied. He gained his points at times by great sacrifices, and the defeat of Conkling and Platt and their consequent resignation severed his long friendship with them. But he always stood for what to his mind was right, and did not permit his heart to overrule his judgment.

GARGANO, PROMONTORY OF, a peninsula of southern Italy, extending thirty miles into the Adriatic Sea, eastward, from the northern end of Apulia. It has two ranges of mountains, that on the north side being noted for its honey, even in the time of Horace. The southern range is barren. See also APULIA, Vol. II, p. 216.

GARGARON, a peak of Mount Ida, southern Troja, Asia Minor, 10 miles N.W. of Adrimyttium. Its modern name is Kaz-Dagh. The town GARGARA is supposed to have been founded at the summit of the mountain, where there is a large inclosure, but later to have been colonized from Miletus and removed to the foot of the mountain.

GARGET, a name sometimes given to the common poke, or pokeweed (*Phytolacca decandra*), also sometimes called scoke. The root (garget-root, or poke-root) is acrid-poisonous; the very young leaves are sometimes used as a pot-herb, but with considerable danger, and the abundant dark crimson-purple berries are used for coloring, though the color is not permanent.

GARGOYLE. See ARCHITECTURE, Vol. II, p. 465.

GARIBALDI, GIUSEPPE, an Italian soldier and patriot; born in Nice, July 4, 1807. He began a

busy life as a sailor, and while in command of a vessel visiting various ports of Italy, formed acquaintances among the leaders of the Italian Liberals. In 1834 he became so involved in the unsuccessful revolutionary movement that he was obliged to flee to France. He went to South America, and served in the Uruguayan army against Buenos Ayres. He returned to Italy in 1848, and assisted in the defense against Austria. In 1849 he was in command of the



GIUSEPPE GARIBOLDI.

forces against France and Austria. He was eventually defeated, and obliged to seek safety in the United States. There he remained as a candle-maker in New York until 1854, when he returned to his native home and settled on the island of Caprera. In 1859 he again took up arms, and after fighting at Marsala and Palermo, declared himself Dictator of Sicily. He then captured Naples, and remained in power until Nov. 9, 1860, at which time Sicily was annexed to Italy, when he again retired to private life. He took part in the unfortunate expedition of 1862, and was severely wounded. In 1866 he made his last struggle for Italy, but was defeated at Mentone. He assisted the French against the Prussians in 1870, and in 1875 became a member of the Italian Parliament. He was an extremely radical legislator, and an uncompromising republican. He died in Caprera, June 1, 1882. See, for detailed accounts of the Garibaldian campaigns, ITALY, Vol. XIII, pp. 487-491.

GARIGLIANO, a river of southern Italy, rising in the Abruzzi, southern Latium, west of the former Lake of Fucino, and flowing, after a generally southerly course of 90 miles, into the Gulf of Gaeta. It is navigable below Pontecorvo.

GARLAND, AUGUSTUS HILL, an American statesman and jurist; born in Covington, Kentucky, June 11, 1832. He was admitted to the Arkansas bar in 1853, and in 1861, although he had been opposed to secession, was a member of the provisional congress that met in Montgomery, Alabama. He was a member of the first Confederate Congress, and at the close of the Civil War was a Confederate Senator. In 1867 he was elected to the United States Senate, but was not allowed to take his seat. In 1874 he was elected governor of Arkansas, and in 1876 was sent to the United States Senate. He served as Senator from 1877 to 1885, when President Cleveland appointed him Attorney-General of the United States. Mr. Garland's term of office expired with Mr. Cleveland's retirement from the Presidency in March, 1889, whereupon he engaged in the practice of law in Washington, D. C. Died there, Jan. 26, 1899.

GARLAND, HAMLIN, an American author; born in 1860, in the La Crosse Valley, Wisconsin. His boyhood was spent in a picturesque *coulee*, subsequently described in his stories. His family removed to Iowa, whose prairies form the scenes of

many of his tales. After a local education he spent two years in travel and teaching, and followed the "boom of 1883" to Dakota. He went to Boston and contributed forceful work to the *Transcript* and *Arena*. In 1893 he published *Main Travelled Roads: Six Stories of the Mississippi Valley*, the merits of which obtained an introduction from William Dean Howells and an extensive circulation. *Prairie Folks; or, Pioneer Life on the Western Prairies, in Nine Stories*, and *Prairie Songs*, followed in the same year, and went to establish his fame as a typical Western author. His *Crumbling Idols: Twelve Essays on Art* (1894), was a scholarly and delicate work. His other works were *A Spoil of Office; Rose of Dutcher's Cooley* (1895); *Ulysses S. Grant, His Life and Character* (1898); *Jason Edwards*, and *A Little Norsk* (1898); and *The Spirit of Sweetwater* (1898).

GARLAND, LONDON CABELL, an American educator; born in Lovingsston, Virginia, March 21, 1810. He graduated at Hampden-Sidney College in 1829. He was professor of chemistry in Washington College, Virginia, from 1830 to 1833; president of Randolph-Macon College from 1835 to 1847; professor of mathematics in the University of Alabama from 1847 to 1866; president of the University of Alabama from 1855 to 1866. He was appointed professor of astronomy and physics in the University of Mississippi and remained there until 1875, when he became chancellor of Vanderbilt University, Tennessee, and at the same time occupied the chair of physics. He published, in 1841, a *Trigonometry, Plane and Spherical*. He died in Nashville, Tennessee, Feb. 12, 1895.

GARNEAU, FRANÇOIS XAVIER, a Canadian historian; born in Quebec, June 15, 1809. He was admitted as a notary in 1830. Subsequently he was clerk of the legislative assembly, member of the council of public instruction, and from 1845 till his death, city clerk of Quebec. He was the author of *History of Canada, from the Discovery to Our Own Time* (1852) and *A Voyage to England and France in the Years 1831-33*. He died in Quebec, Feb. 3, 1866.

GARNETT, HENRY HIGHLAND, an American negro clergyman; born, in slavery, in Kent County, Maryland, in 1815. He taught school in Troy, New York, was licensed to preach in 1842, and then was pastor of a Presbyterian church in Troy for nearly ten years. In 1850-53 he lectured on slavery in Europe, and then went to Jamaica as a missionary for the United Presbyterian Church of Scotland, but returned to the United States on account of failing health. In 1855 he became pastor of Shiloh Presbyterian Church, in New York City, and in 1865 accepted a call to a church in Washington, District of Columbia. In 1869 he was chosen president of Avery College, but resigned soon afterward and returned to Shiloh Church. In 1881 President Garfield appointed him minister and consul-general to Liberia, and in November he sailed for Africa. A few months after his arrival he succumbed to the climate, at Monrovia, Feb. 14, 1882.

GARNETT, a city and the capital of Anderson County, central eastern Kansas, 45 miles N.W. of Fort Scott, on the Pottawattomie River, and on the Missouri Pacific and the Atchison, Topeka and Santa

Fé railroads. Cheese and furniture are made here, and the city contains a college, which is under United Presbyterian control, and very good public schools. Population 1900, 2,078.

GARNETT, JAMES MERCER, an American Anglo-Saxon scholar; born in Aldie, Virginia, April 24, 1840. After graduating at the University of Virginia, he studied in the Universities of Berlin and Leipsic. He took part in the Civil War, in the Confederate army. He was instructor in English in various colleges until 1882, when he was appointed to the chair of English language and literature in the University of Virginia. He wrote a number of translations of Anglo-Saxon writings; among them, *Beowulf's Fight at Finnsburg* (1882); *Anglo-Saxon Poems* (1889); and *Selections in English Prose from Elizabeth to Victoria* (1891).

GARNETT, RICHARD, an English author; born in Lichfield, England, Feb. 27, 1835. His father, the Rev. Richard Garnett, was an eminent author and philologist, and one of the librarians of the British Museum. The younger Garnett was appointed assistant keeper of that great library when his father died in 1850. From 1875 until 1884 he was superintendent of the reading-room. In 1884 he gave up all else to devote his time to the museum catalogue. He wrote numerous contributions to periodicals, and two volumes, one a collection of tales, *The Twilight of the Gods* (1888), and *Carlyle* (1883). He published, also, *Relics of Shelley* (1862); *Selections of Shelley's Poems* (1880); *Letters* (1882); and *Iphigenia in Delphi* (1890). He contributed the article on AUGUSTAN HISTORY to this ENCYCLOPÆDIA, and numerous other articles.

GARNETT, ROBERT SELDEN, an American soldier; born in Essex County, Virginia, Dec. 16, 1819; graduated at West Point in 1841; distinguished himself in Mexico as aide-de-camp to General Taylor; was for two years commandant of cadets at West Point, and commanded an expedition to Puget Sound in 1856. At the outbreak of the war he joined the Confederacy, received a brigadier-general's commission and was killed in battle at Carriek's Ford, Virginia, July 13, 1861.

GARNIER, JEAN LOUIS CHARLES, French architect; born in Paris, Nov. 6, 1825; gained the grand prize at the École des Beaux-Arts in 1842, and continued his studies in Greece and Italy. The new Paris Opera House was built from his design and under his direction (1861-75). He also built the theater and gambling-house at Monte Carlo, and the Nice observatory. He was an officer of the Legion of Honor, a member of the Academy of Fine Arts and of the Institute of France. He wrote *Progress of Art* (1869); *The Theater* (1871); *A Monograph on the Observatory at Nice* (1890); and *Human Habitations* (1891). Died in Paris, Aug. 4, 1898.

GARNIER-PAGES, LOUIS ANTOINE, a French author and statesman; born in Marseilles, July 18, 1803. In 1830 he took part in the revolution at Paris, and was afterward elected to the Chamber of Deputies as a Republican. In the provisional government of 1848 he was Minister of Finance. But he was soon forced to retire into private life, because he insisted on extra taxation in order to save the

state from bankruptcy. In 1869 he was again elected to the Corps Legislatif. When the Germans besieged Paris he took part in the defense of the city. Among his writings are *History of the Revolution of 1848* (1862) and *The Opposition and the Empire* (1872). He died in Paris, Oct. 31, 1878.

GARNISHMENT, a legal proceeding for the purpose of reaching personal property, such as money or goods, which belong to a debtor, but which are at the time in the possession of a third person. The person in whose possession such goods are at the time, and against whom the garnishment proceeding is begun, is termed the garnishee. He is required to appear in court upon a day mentioned, and answer, usually under oath, as to what amount he may have owed the debtor on whose account he is garnished, or what money, goods, etc., belonging to such debtor he may have held at the time summons was served upon him, or since said time. He is required to retain possession of any property which is subject to garnishment which he had in his possession when service was had upon him, or which comes into his hands since service and before the hearing, so that he may have such property subject to the order of court.

Garnishment proceedings are governed entirely by statute in the various states, but, as a rule, such proceedings are allowed either as an auxiliary to an attachment suit, in which case the garnishee is served with a copy of the attachment writ and required to hold any property belonging to the debtor until the final hearing of the attachment against the principal defendant, or by an independent suit which may be begun by the creditor in the name of his debtor against the garnishee. This latter proceeding can be generally maintained only after judgment against the principal debtor. The former proceeding can only be had when some statutory grounds exist for attachment against the principal debtor.

Garnishment is a very efficient remedy, by reason of the prompt manner in which property of the debtor in the hands of others may be reached and held to await the outcome of the suit. Judgment can be had against the garnishee only for the amount in his hands, if he appears and discloses what that amount is. If not, judgment will go against him for the full amount of the claim against the principal debtor. If the garnishee held more than the amount of the debt, the balance goes to the principal debtors. See also EXEMPTION LAWS, in these Supplements.

GAROFALO OR IL GAROFALO. See TISTO, Vol. XXIII, p. 409.

GAR-PIKE (*Belone*), a genus of bony fishes in the family *Scombrosideæ*, not far from the true pikes (*Esocidae*). They have long bodies, and both jaws are prolonged into a slender beak, beset with roughnesses and widely set teeth. They swim actively, with an undulating motion, near the surface, and catch small fishes in their jaws. The common gar-pike (*B. vulgaris* or *B. belone*) is frequent off British coasts, and is sometimes called greenbone, from the color of the bones (especially after cooking); gore-bill, from its characteristic beak; or mackerel-gride,

because it visits the coasts just before the mackerel. About fifty species are known, from tropical and temperate seas, some twice as long as the British species. See also *Lepidosteus*, under ICHTHYOLOGY, Vol. XII, p. 687.

GARRETSON, JAMES EDMUND, an American physician; born in Wilmington, Delaware, Oct. 4, 1828. He was graduated at the University of Pennsylvania in 1859. He began to practice in Philadelphia, and from 1861 to 1863 was lecturer on anatomy, from 1866 to 1869 lecturer on surgery, in the University of Pennsylvania, and in 1879 became dean of the Dental College of Philadelphia. He published *System of Oral Surgery* (1869); *Thoughts and Thinking* (1873); *Brushland* (1882); and *Nineteenth Century Sense* (1887).

GARRETT, JOHN WORK, an American railroad president; born in Baltimore, July 31, 1820; was best known as president of the Baltimore and Ohio railroad, holding that office from 1858 until his death. He was also interested in ocean steamship navigation. He organized and built up the present extensive Baltimore and Ohio system. He died in Deer Park, Garrett County, Maryland, Sept. 26, 1884.—His son, ROBERT GARRETT, was born in Baltimore, April 9, 1847; became connected with railroad affairs at an early age, and in 1884 succeeded his father as president of the Baltimore and Ohio railroad. Previously he had served as president of the Valley Branch, third vice-president of the Baltimore and Ohio, and first vice-president of the system. When he assumed the presidency, the financial troubles of the road were just beginning. Succeeding losses and expenses, and the purchase, without his consent, of the Baltimore and Ohio telegraph lines by Jay Gould, served to unbalance his mind for a time, and to prevent him from active participation in the management of the road after 1887. He died in Deer Park, Maryland, July 29, 1896.—His sister, MARY ELIZABETH G., was a well-known philanthropist and promoter of higher education for women; a liberal patron of Bryn Mawr, and in 1892 donated over three hundred thousand dollars to found, in connection with Johns Hopkins Hospital, a medical college where women as well as men should be admitted.

GARRETTSVILLE, a village of Portage County, northeastern Ohio, on a division of the New York, Lake Erie and Western railroad, 37 miles E.S.E. of Cleveland. It has machine-shops, and rake, table and pail factories, and a factory of maple-syrup making machinery. Population 1900, 1,145.

GARROD, SIR ALFRED BARING, a British physician; born in Ipswich, England, May 13, 1819. After his graduation from the University of London in 1842, he received various important appointments in the London medical colleges and hospitals. His discovery of uric acid in the blood of patients suffering from gout brought him considerable fame. He published *Conversion of Benzoic Acid into Hippuric Acid in the Animal Economy* (1843); *Condition of the Blood in Cholera* (1849); *Gout and Rheumatic Gout* (1860); and other works on medical topics.

GARROD, ALFRED HENRY. See ORNITHOLOGY, Vol. XVIII, pp. 39-41, 47.

GARROT, a name given to a European sea-duck of the genus *Glaucionetta*. This name is not used in America. The North American variety is known as the golden-eye, on account of the yellowish color of its eyes.

GARROTE, a mode of execution practiced in Spain and the Spanish colonies. Originally it consisted in simply placing a cord around the neck of the criminal, who was seated on a chair fixed to a post, and then twisting the cord by means of a stick inserted between the post and the back of the neck, till strangulation was produced. Afterward a brass collar was used, containing a screw, which the executioner turned till its point entered the spinal marrow where it unites with the brain, causing instantaneous death.

GARTER, ORDER OF. See KNIGHTHOOD, Vol. XIX, pp. 122-23.

GARY, JAMES A., American manufacturer and financier; born in Uncasville, Conn., Oct. 22, 1833, and taken to Howard County, Maryland, with his parents in 1840. Having graduated at Allegheny College he entered his father's counting-room in 1854, and in 1861 became a partner in the business at Alberton. On the death of his father in 1870 he became the head of the firm. Mr. Gary has extensive banking and financial interests, and his cotton mills are thought to be the largest in the world. For many years he has been conspicuous as a leader in Republican politics, but never held office until appointed Postmaster-General on March 5, 1897.

GAS, HEATING BY. See FURNACES, in these Supplements.

GASCONADE, a river of southeastern Missouri, rising in two forks, in Webster and Wright counties, and winding 200 miles northeastward, through a hilly and picturesque country, till it joins the Missouri River, 35 miles below Jefferson City. It is navigable as far as Arlington, about half its length.

GAS-ENGINE. See STEAM-ENGINE, Vol. XXII, pp. 522-526.

GAS OR GASOLINE MOTORS. See MOTORS, in these Supplements.

GASPARIN, AGÉNOR ÉTIENNE, COMTE DE, a French author and publicist; born at Orange, France, July 10, 1810. His father, Comte Adrien É. P., was, in 1836, Secretary of the Interior, and Agénor at that time was employed under his father. In 1842 he was selected to the Chamber of Deputies. Although a member of the nobility of France, Comte Gasparin favored many liberal measures, being moved thereto by his Protestant principles. During the revolution of 1848 he was in the East. He did not favor the empire established by Napoleon III. For this reason he removed to Switzerland, and lectured at Geneva on social, religious and historical subjects. An enemy to slavery, he expressed the warmest friendship for the cause of the American Union during the Civil War, and published two works on the subject: *Les États Unis en 1861: Un Grand Peuple qui se Relève* (1861) and *L'Amérique devant l'Europe* (1862) translated and published under the titles *Uprising of a Great People* and *America before Europe*. Count Gasparin also published several works on

French Protestantism, spiritualism, the family, moral liberty, and the *Life of Innocent III* (1874). His philanthropic labors in behalf of French refugees who flocked to Geneva hastened his death, which occurred May 14, 1871.

GASPÉ, a cape, peninsula and bay in Gaspé County, Canada, at the extreme eastern part of Quebec. The cape, which ends the promontory, lies at lat. 58° 43' N., long. 64° 14' E. It rises 690 feet above sea-level, a bleak, towering cliff. Just south of the cape is Gaspé Bay, which extends 15 miles inland to the northwest, is about 4 miles wide and is separated from the Gulf of St. Lawrence by Gaspé Peninsula, which extends southeast, and is formed by the Dartmouth River, the Gulf of St. Lawrence and Gaspé Bay. The name is sometimes applied to the whole promontory, comprising Gaspé and Bonaventure counties.

GAST, FREDERICK AUGUSTUS, an American Reformed Church theologian; born in Lancaster, Pennsylvania, Oct. 17, 1835. He received his collegiate instruction at Franklin and Marshall College, Pennsylvania; entered the ministry of the Reformed Church, and was active in pastoral work until 1874, when he became professor of Hebrew and Old Testament theology in the Lancaster Theological Seminary. He was a constant contributor to the *Reformed Quarterly Review* and other church periodicals. Among his articles were *Origin of Old Testament Religion* (1876); *Claims of the Semitic Languages* (1881); *The Pre-semitic Babylonians* (1885); and *The Mystery Language* (1888).

GASTEROMYCETES, a sub-order of fungus. See FUNGUS, Vol. IX, p. 833.

GASTEROPODA, a division of mollusks, including (all) snails and slugs. See MOLLUSKA, Vol. XVI, pp. 632, 641-645.

GATACRE, LIEUT.-GENERAL SIR WM. FORBES, K. C. B., in command of the 3rd army division in South Africa in the Boer war, was born in 1843, and entered the army in 1862. In 1874 he passed the Staff College, and was for four years (1875-79) instructor of military surveying at the Royal Military College. In 1888 he was with the Hazara Expedition, served in Burma; was made a C. B. and received medal and clasp for services in Chitral; commanded a division in the Sudan during the advance on Khartum and Omdurman, and was mentioned in despatches and received the thanks of both Houses of Parliament. In 1898 he was created a K. C. B. In 1899 he was appointed by the British military authorities to a command in South Africa, with the rank of Lieut.-General, and frequently distinguished himself in the war. He has the reputation of being an excellent though too daring general.

GASTRULA. See ZOÖLOGY, Vol. XXIV, p. 811; MORPHOLOGY, Vol. XVI, p. 842.

GATES, MERRILL EDWARDS, an American educator; born in Warsaw, New York, April 6, 1848. He attended the University of Rochester and graduated at that institution in 1870. He was president of Albany Academy from 1870 to 1882; of Rutgers College from 1882 to 1890; and became the head of Amherst College in 1890. He was appointed a

member of the United States Indian Commission in 1884. He contributed valuable articles to current periodicals and delivered a number of addresses, which have been published. Among his articles are *Sidney Lanier: Land and Late as Agents in Educating Indians*; and *The Debt the School Owes the State*.

GATES, SIR THOMAS, a colonial governor of Virginia, prominent in the seventeenth century. His name first appears when the second charter of Virginia was given to a company on May 23, 1609. The officers therein named were West, De la Warr, Somers, Newport, Dale, Wainman and Sir Thomas Gates as lieutenant-general. The colonization of Virginia thereafter became greatly stimulated, and money was contributed in aid of the purpose, and nine vessels, with nearly six hundred emigrants, left Europe for America, under Newport, Somers and Gates. They sailed in May, 1609. Only seven ships reached Virginia; one, with its passengers, was lost at sea; the other, that conveyed Gates, was stranded at one of the Bermuda Islands. Here Gates and his companions improvised two small vessels in the course of nine months, and set sail for their original destination, which they reached on May 24, 1610. They found the Virginia colony in a condition of anarchy and neglect, and its numbers reduced by sickness and famine to about fifty individuals. Gates and the colonists then decided to abandon the settlement and sail coastwise for Newfoundland in four remaining pinnaces that still floated on the river, and seek a passage to England. But no sooner had they begun their voyage than they encountered Lord de la Warr, who, ascending the river on June 9, 1610, with new colonists and fresh supplies, persuaded Gates and his party to return to Jamestown. Lord de la Warr had promised to send to the council an early report of the condition of the colony, and for this purpose dispatched Sir Thomas Gates to England, who, with great energy, gathered means and recruits, and in August, 1611, reached Jamestown safely, with six vessels and about three hundred colonists. He assumed the functions of governor, established divine worship, law and order, and in 1611 made new settlements in Henrico. In March, 1612, a third patent was granted to the company by the crown, that, for the time being, gave them control of the Bermuda Islands, and all other islands within three hundred leagues of the Virginia shore. Sir Thomas Gates returned to England in 1614 in the interest of the colonists. Of his subsequent history we have no record.

GAFESVILLE, a city and the capital of Coryell County, east-central Texas, 82 miles N. of Austin, on Little River, and on the terminus of a branch of the St. Louis Southwestern railroad. It is engaged in farming, stock-raising and produce-shipping, being in a rich district. Located here is a state house of correction. Population 1880, 434; 1890, 1,375; 1900, 1,865.

GATINEAU, a river of Quebec, in Canada, which has its origin in a chain of lakes lying immediately north of lat. 48° N., and west of long. 75° W., and, after a south-southwesterly course of four hundred

miles, enters the Ottawa River a mile below Ottawa City.

**GATLING, RICHARD JORDAN**, an American inventor; born in Hertford County, North Carolina, Sept. 12, 1818. At the age of twenty he invented a screw for propelling steamers, and later a machine for sowing rice and wheat. In 1850 he invented a hemp-brake; in 1857, a steam-plow; and then a machine for transmitting power by means of compressed air. His fame is based, however, upon his invention of the revolving battery which bears his name. It consists of a number of breech-loading rifled barrels, made to revolve around a common center, and fed with cartridges by a hopper. The new gun, with ten barrels, is capable of firing twelve hundred shots per minute. In 1866 it was adopted into the United States service. It has also been adopted by several European governments. More recently he invented an improved method of casting large steel cannon, a torpedo and gun boat, and a pneumatic gun for discharging high explosives which has been subjected to severe tests.

**GATSCHET, ALBERT SAMUEL**, a Swiss-American ethnologist; born in St. Beatenberg, Switzerland, Oct. 3, 1832. He studied in Neuchâtel, Bern and Berlin, and after engaging in researches concerning the etymology of Swiss dialects, he went to England, and in 1867 to America. In connection with the United States Geological Survey he made a study of the languages and customs of the North American Indians. He contributed a number of valuable papers to the reports of the survey. He became connected with the Smithsonian Institution in 1879. His principal work is embodied in volume 2 of *Contributions to North American Ethnology*, published by the government in 1890.

**GAUCHOS**, a mixed race. See ARGENTINE REPUBLIC, Vol. II, p. 493.

**GAUGAMELA. VILLAGE OF**, scene of a decisive battle, where the Persians were overthrown. See ALEXANDER THE GREAT, Vol. I, p. 482.

**GAUGE OF RAILWAYS**. See RAILWAY, Vol. XX, p. 241.

**GAULEY**, mountains and a river of central West Virginia. The mountain chain, in Kanawha and Fayette counties, extends from the Kanawha River, near Charleston, eastward for about thirty miles, divided near the middle into two ridges. Between these two ridges flows the Gauley River. It rises in Pocahontas County, in the Black Mountains, flows west past the eastern Gauley Mountains, then turns south and flows into the New River, which beyond this point is called the Great Kanawha. The Gauley River has a course of about 75 miles.

**GAULT OR GALT**. See GEOLOGY, Vol. X, pp. 357-359.

**GAULTHERIA**, a genus of shrubby and trailing plants of the family *Ericaceæ*, or heaths. They have alternate, broad and often spicy evergreen leaves and a berry-like fruit. *G. procumbens*, known as creeping wintergreen, boxberry and checkerberry, with nodding, white flowers in the axils of the leaves, is the common species of the Atlantic region, whose persistent red berries and leaves yield the oil of wintergreen. *G. Shallon*, a more robust form, with

flowers in racemes, is the common species of the Pacific region.

**GAUR OR GAYAL** is a wild ox (*Bibos gaurus*) found in the Indian jungles. The animal is dark brown in color, except the legs, which are white below the knees. Many naturalists believe this animal to be the ancestral stock of the domesticated gyal. The wild gyal inhabits the mountainous regions. Some naturalists consider it a separate species; but it is highly probable that most, if not all, of the Indian wild cattle are local races of the genus *Bibos*.

**GAUSS'S THEOREM**. See ELECTRICITY, § 19, in these Supplements.

**GAUTAMA OR GOTAMA**, name of Sidhartha, the Buddha. See BUDDHISM, Vol. IV, pp. 425 et seq.

**GAVAZZI, ALESSANDRO**, an Italian patriot evangelist; born at Bologna, Italy, March 21, 1809; entered the order of the Barnabites in 1825. He became professor of rhetoric in the University of Naples. In 1848 he delivered an oration on the patriots who had fallen at Milan, and was made chaplain-general of the forces by Pope Pius IX, who at that time favored the Liberal movement. But the pope went over to the Reactionaries and recalled the Roman legion from Vicenza, and Gavazzi fled to Tuscany and Genoa. On his return to Rome he was arrested, but was freed when the pope fled and the Republican government was established. The French captured Rome in July, 1849, and Gavazzi escaped to London, where he taught Italian and lectured against Romanism. Subsequently he visited Scotland, the United States and Canada, and in the latter country his orations against Roman Catholicism gave rise to riots. In 1860 he participated in the Garibaldian expedition to Palermo; in 1870, revisited England; and in 1873 made a tour in the United States. He published his *Orations* (1851); *No Union with Rome* (1871); *Recollections of the Last Four Popes* (1859), and *The Priest in Absolution* (1877). He died in Rome, Jan. 9, 1889.

**GAVIÆ**, a group of birds, composed of the gulls. It is equivalent to the superfamily *Laroidæ* of some authors. Both of above groups are equivalent to the order *Longipennes*, without the petrels. Authors who use either of the first-mentioned terms place the petrels in another group.

**GAVIAL OR NAKOO**. See CROCODILE, Vol. VI, p. 593.

**GAVILIAN OR SIERRA MORENA**, a branch of the Coast Range, in California, just south of San Francisco, extending through the counties of San Mateo and Santa Cruz. The highest point is Mt. Pacheco, 2,845 feet high.

**GAY, CLAUDE**, a French botanist; born in Draguignan, March 18, 1800. After studying zoölogy in Paris and Asia Minor and Greece, he went to Chile, in 1828, to study the flora of that country. From 1833 to 1843 he made an exploration of Chile for the government. He gathered zoölogical and botanical specimens, and also collected historical data. He returned to France, and from 1856 to 1858 traveled in Russia, Tatar and the United States. He published *A Scientific and Political History of Chile* (1851); *The Mines of Peru as Compared with Those*

of Chile (1855); and *Report to the Academy of Sciences on the Mines of the United States* (1861). He died in Paris, April 6, 1863.

GAY, EBENEZER, an American Unitarian clergyman; born in Dedham, Massachusetts, Aug. 26, 1696; died in Hingham, Massachusetts, in 1787. In 1718 he became pastor of the church at Hingham, where he remained till his death, preaching in the same pulpit within three months of seventy years. He published many sermons, of which one, *The Old Man's Calendar*, obtained a wide circulation. This was preached on his eighty-fifth birthday. He was one of the founders of American Unitarianism.

GAY, EDWARD, an American artist; born in Ireland in 1837; came to the United States when a boy; studied at Carlsruhe and Düsseldorf, and in 1867 opened a studio in New York. He contributed regularly, both to the National Academy and the exhibitions of the Water-Color Society, and was successful in landscapes. Among his paintings are *Mountain Stream* (1860); *Ready for the Reapers* (1875); *Oyster-beds in Pelham Bay* (1885); and *Salt Marshes* (1885).

GAY, SIDNEY HOWARD, an American author; born in Hingham, Massachusetts, in 1814. In 1842 he became a lecturing agent for the American Antislavery Society, and from 1844 to 1857 was editor of the New York *Antislavery Standard*. He then became connected with the *Tribune*, and from 1862 to 1866 was managing editor. From 1867 to 1871 he was editor of the Chicago *Tribune*, and from 1872 to 1874 was on the editorial staff of the New York *Evening Post*. He was an ardent abolitionist; wrote a *History of the United States* (1881) in conjunction with William Cullen Bryant, and was the author of a *Life of James Madison* (1884). He died June 25, 1888, in New Brighton, Staten Island.

GAY, WINCKWORTH ALLAN, an American artist; born in Hingham, Massachusetts, Aug. 18, 1821. He studied in Italy and France, and traveled in Egypt, China and Japan. Among his pictures exhibited at the National Academy in New York are *Mackerel Fleet, Beverly Coast, Massachusetts* (1869); and *The Dog's Palace, Venice* (1875). His *Windmills of Delfshaven, Holland*, was at the Centennial Exhibition at Philadelphia in 1876.

GAYARRÉ, CHARLES ÉTIENNE ARTHUR, an American historian; born in New Orleans, Louisiana, Jan. 9, 1805. After several years of study in New Orleans and Philadelphia, he was admitted to the bar in 1829; was elected to the Louisiana legislature in 1830; appointed deputy attorney-general of the state in 1831, and in 1833 presiding judge of the New Orleans city court. In 1835 he was elected to the United States Senate, but impaired health prevented his taking his seat. In 1844 he again became a member of the state legislature, and was re-elected in 1846. The same year he was appointed secretary of state, and again in 1850, retaining the office till 1857. He supported the Confederacy during the Civil War, at the close of which he became reporter of the state supreme court. He was the author of many historical works; among them, *History of Louisiana* (1866); and two novels, *Fer-*

*nando de Lemos* (1872); and *Aubert Dubayet* (1882). He died in New Orleans, Feb. 11, 1895.

GAYARRE, JULIAN, a Spanish tenor singer; born in Pamplona, Navarre, in 1850; died in Madrid, Jan. 2, 1890. His voice early attracted the attention of Professor Eslava, who took him to Madrid. His career was most successful. The leading European cities lauded him as the greatest tenor of his age, and many thought him the equal of Mario. Though lacking somewhat in dramatic talent, he had true musical sensibility, and was able to interpret Wagner and other dramatic composers.

GAY-FEATHER, a local name for certain species of *Liatris*, a handsome genus of the family *Compositae*, with slender erect stems, narrow alternate leaves and spiked or racemed heads of showy purple flowers. The species are more generally known as button snake-roots or blazing-stars.

GAY HEAD, a promontory of Dukes County, southeastern Massachusetts, forming the western portion of the island of Martha's Vineyard. Its rocks abound with Miocene fossils. The inhabitants are chiefly Indians, who live by farming and fishing. Here is a revolving light, raised 170 feet above the sea, at lat. 41° 21' 52" N., long. 70° 49' 57" W. Population 1900, 173.

GAYLORD, a village and the capital of Otségo County, northern Michigan (South Peninsula), on the Mackinaw division of the Michigan Central railroad, 50 miles S. of Mackinaw. It is in a farming and lumbering district, has lumber-mills and a potash factory. Population 1900, 1,561.

GAZELLÉ. See ANTELOPE, Vol. II, p. 101.

GEAR, JOHN HENRY, an American public man; born in Ithaca, New York, April 7, 1825; removed to Iowa in 1838, and in 1843 engaged in business at Burlington, of which city he was mayor in 1863. He was three times elected to the state general assembly, and served two terms as speaker of the house. In 1878-79, and again in 1880-81, he was governor of the state, and was elected to the Fiftieth and Fifty-first Congresses by the first Iowa district, as a Republican. In 1892 he was elected to the Fifty-third Congress, and in 1895 became United States Senator.

GEARY, JOHN WHITE, an American soldier and statesman; born near Mount Pleasant, Westmoreland County, Pennsylvania, Dec. 30, 1819. He studied civil-engineering and law, and was admitted to the bar, but never practiced. During the Mexican War he was lieutenant-colonel of the Second Regiment of Pennsylvania, and for services rendered in the field was made first commander of the City of Mexico, and colonel of his regiment. In 1849 he was appointed first postmaster of San Francisco, and in 1850 was made mayor of that city. In 1856 he was appointed territorial governor of Kansas, and held the office one year.



GENERAL GEARY.

At the beginning of the Civil War he raised the Twenty-eighth Pennsylvania Volunteers, and during the war commanded in several engagements, notably Chancellorsville, Gettysburg and Lookout Mountain. He was with Sherman in the march to the sea. He several times won distinction, and attained the rank, by brevet, of major-general. In 1866 he became governor of Pennsylvania, and held the office to within two weeks of his death. He died in Harrisburg, Pennsylvania, Feb. 8, 1873.

GEARY, THOMAS J., an American lawyer and public man; born in Boston, Massachusetts, Jan. 18, 1854; removed with his parents to California in April, 1863; studied law, and was admitted to the bar in 1877, and engaged in the practice of his profession; was elected district attorney of Sonoma County in 1882, and served two years; was elected, as a Democrat and American, to the Fifty-first and Fifty-second Congresses, and was re-elected to the Fifty-third Congress. While in Congress he drew up and introduced the Chinese Exclusion Act of 1892.

GEDDES, JAMES LORRAINE, a British soldier; born in Edinburgh, Scotland, March 19, 1827; served in India under Gough, Napier and Campbell, and in 1857 settled in Iowa. He enlisted as a private in an Iowa volunteer regiment in August, 1861, was rapidly promoted to brigadier-general, and did good service at Memphis and Mobile. After the war he had charge of the Blind Asylum at Vinton, Iowa, and was connected with the Iowa College of Agriculture in Story County. He was the author of several popular war-songs; among them, *The Stars and Stripes* and *The Soldier's Battle Prayer*. He died in Ames, Iowa, Feb. 21, 1887.

GEEZ LANGUAGE. See ETHIOPIA, Vol. VIII, pp. 612, 613.

GEFFCKEN, FRIEDRICH HEINRICH, a German writer on international law; born in Hamburg, Dec. 9, 1830. He entered the diplomatic service, and among other positions, held that of resident minister in London. He was appointed professor of public law at Strasburg in 1872 and remained there until 1882. In 1888 he gained considerable notoriety by his publication of *The Emperor Frederick's Diary, 1870-71*. He was tried for high treason, but acquitted. Among his legal writings are *The Coup d'État of 1851*, and several volumes on the *Alabama* question, the constitution of the German confederation, and the question of the Danube. He died in Munich, April 30, 1896.

GEFFRARD, FABRE, a Haitian President; born in Anse Veau, Haiti, Sept. 19, 1806. In 1821 he enlisted as a private soldier in the Haitian army, and rose by successive promotions to a captaincy. In 1843 General Herard Rivière appointed Geffrard lieutenant-colonel, and he was soon afterward appointed colonel. In 1844 he became brigadier-general and commander of Jacmel. In 1845 he was appointed general of division, and in 1850 was created Duke of Tabaro. In 1859 he headed a revolt against Soulouque's government and became President of Haiti. In 1867 his government became unpopular, and there was a revolt under Salnave.

Geffrard, seeing that resistance was useless, took refuge on board a French vessel and went to Jamaica, where he died, in Kingston, Feb. 11, 1879.

GEGENBAUR, CARL, a German anatomist; born in Würzburg, Aug. 21, 1826. He received his education at the university of his native city, and instructed there from 1853 to 1855. From 1855 to 1872 he was medical professor at the University of Jena, and in 1872 became professor of anatomy at Heidelberg. He was a recognized authority on comparative anatomy. He became editor in 1876 of the *Morphologisches Jahrbuch*. His principal publications are his *Outlines of Comparative Anatomy* (1878) and *Human Anatomy* (1890).

GEHENNA, the Greek form of the Hebrew *Gehinnom*, or Valley of Hinnom. This valley, or rather narrow gorge, lies south and west of the city of Jerusalem. Here Solomon built a high place for Molech (1 Kings xi, 7), and indeed Gehenna seems to have become a favorite spot with the later Jewish kings for the celebration of idolatrous rites. It was here that Ahaz and Manasseh made their children pass through the fire, "according to the abomination of the heathen"; and at its southeast extremity, specifically designated Tophet ("place of burning"), the hideous practice of infant-sacrifice to the fire-gods was not unknown (Jer. vii, 31). When King Josiah came forward as the restorer of the old and pure national faith, he "defiled" the Valley of Hinnom by covering it with human bones, and after this it appears to have become "the common cesspool of the city, into which its sewage was conducted, to be carried off by the waters of the Kedron, as well as a lay-stall, where all its solid filth was collected. Hence it became a huge nest of insects, whose larvæ, or 'worms,' fattened on the corruption." It is also said that fires were kept constantly burning here to consume the bodies of criminals, the carcasses of animals, and whatever other offal might be combustible. Among the later Jews, *Gehenna* and *Tophet* came to be symbols for hell and torment, and in this sense the former word is frequently employed by Jesus in the New Testament, e.g., Mark ix, 47, 48. See ESCHATOLOGY, Vol. VIII, pp. 536, 537.

GEIKIE, SIR ARCHIBALD, a Scottish geologist, and director-general of the Geological Survey of Great Britain; born in Edinburgh in 1835, and educated at the high school and the university of his native city. In 1855 he was appointed to the Geological Survey; in 1867 he became director of the survey of Scotland, and three years later was first occupant of the new chair of geology and mineralogy in the University of Edinburgh. In 1882 he resigned the chair, and was succeeded by his brother, Professor James Geikie, having, in the previous year, been appointed director-general of the Geological Survey of the United



SIR ARCHIBALD GEIKIE.



Kingdom and director of the Museum of Practical Geology in London. In 1890 and 1892 he was successively president of the Geological Society and president of the British Science Association, and in 1891 was knighted for his services to geological science. He published numerous geological articles, contributed to the magazines and to the transactions of learned societies. He was also a prolific author of works on geology and physical geography, and of memoirs of notable scientists. The chief of these are *The Story of a Boulder* (1858); *Life of Edward Forbes* (1861), written with the late Professor George Wilson; *The Phenomena of the Glacial Drift of Scotland* (1863); *A Student's Manual of Geology* (with the late Prof. J. Jukes); *Class-Book of Physical Geography* (1877); *Outlines of Field Geology* (1879); *Text-Book of Geology* (1884); *Class-Book of Geology* (1886); *Life of Sir Roderick Murchison* (2 vols., 1875); *Memoir of Sir A. C. Ramsay*, of the Geological Survey (1894); *The Ancient Volcanoes of Britain* (1897); *The Founders of Geology* (1897); and *Types of Scenery, and their Influence on Literature* (1898). He wrote the elementary treatise on geology in the Science Primers. As a writer, Sir Archibald had the gift of lucidity, and the faculty of treating abstruse topics in a popular manner. He paid a quasi-professional visit to the United States, and wrote for *Macmillan's Magazine* two interesting papers on *The Bad Lands of Wyoming* and *The Geysers of the Yellowstone*.

GEIKIE, JAMES, a Scottish geologist, and Murchison professor of geology and mineralogy in the University of Edinburgh; born in Edinburgh in 1839, and educated at the high school and the University of Edinburgh. He was a younger brother of Sir Archibald Geikie and related to the Rev. J. Cunningham Geikie, the divine and author. In 1861 he joined the Geological Survey staff, and rose to be local director of the survey in Scotland. In 1882 he resigned the latter position to accept the geological chair in the university, as successor to his brother. Professor Geikie was one of the founders of the Royal Scottish Geographical Society, and member of numerous British and foreign scientific societies; he was also the author of a number of papers dealing with Palæozoic and Pleistocene geology and physical geography. His most important work is *The Great Ice Age, and Its Relation to the Antiquity of Man* (1874; 3d ed. 1894), which has been reprinted in the United States and is widely known for its original research and able treatment of its attractive theme. In 1881 he published a geological sketch, entitled *Prehistoric Europe*, and in 1886 a work on the *Outlines of Geology*. In 1887 he edited the *Songs and Lyrics of H. Heine and Other German Poets*, and in 1893 returned to his special theme in *Fragments of Earth-Lore*.

GEIKIE, JOHN CUNNINGHAM, a Scottish divine and religious writer; born at Edinburgh, Oct. 26, 1824. The son of a clergyman, he early studied for the ministry, and held pastorates in the Presbyterian and Congregational churches in Canada and in England. In 1876 he entered the Church of England, and had clerical charges at Dulwich, Barnstaple and Norwich, England, and for a time preached to an English congregation in Paris. His early writings

embrace *The Backwoods of Canada* and *Entering on Life*, books for young men, as well as a number of works of an educational character. In 1875 appeared a thoughtful work on *The English Reformation*, which ran through many editions. This was followed by his *Life and Words of Christ*, which first appeared in 1876, and of which thirty-two editions have been published, besides several reprints in the United States. The work, which is the rival of Dean Farrar's *Life of Christ*, is distinguished for its scholarship and learning, and, as befits its theme, is less rhetorical than that of the perhaps better-known life by the Dean of Westminster. This was followed by *Old Testament Characters* (1877); a series of six volumes entitled *How to read the Bible; or, The Scripture in the Light of Modern Discovery and Knowledge* (1880-85); *A Short Life of Christ* (1885); *The Holy Land and the Bible* (1887); a series of *New Testament Hours* (1893); *Landmarks of Old Testament History* (1894); and *The Bible by Modern Light* (1894). Died in London, Oct. 6, 1898.

GEISLER PUMP. See MERCURIAL AIR-PUMP. Vol. XVI, p. 39.

GELATINO-BROMIDE PROCESS. See PHOTOGRAPHY, in these Supplements.

GELDERLAND, a province in the central western part of the Netherlands, bounded by Zuyder Zee, Germany and the provinces of North Brabant, South Holland, Utrecht and Overijssel. The Rhine, Yssel, Waal and other rivers run through the province, and along their banks the soil is fertile, and produces tobacco, rye, wheat and buckwheat, and fine cattle are also raised. Area, 1,965; population 1895, 534,737.

GELEE. See CLAUDE OF LORRAINE, Vol. V, pp. 814, 815.

GELIDIUM, a genus of red sea-weeds, said to be utilized in the building of the edible birds'-nests so much prized by the Chinese. These and allied species are largely used for food in the East, as yielding wholesome jellies. *Gelidium* is one of the genera which yields the well-known jelly agar-agar, much used as a culture-medium in biological laboratories.

GEMBLOUX OR GEMBLOURS, a town of Belgium, province of Namur, 10 miles N.E. of the city of Nemur, celebrated as the scene of the victory of Don John of Austria over the United Netherlands in 1578. A state agricultural establishment is located here. Population, about 3,000.

GEMMÆ, in botany, a name given to certain special organs for vegetative multiplication. The gemmæ most commonly observed are those of certain liverworts (*Marchantia* and *Lunularia*), in which they are flat, many-celled bodies, which develop from the surface of the thallus within a little cup or crescentic sac (cupule), and upon germination give rise to a new thallus. Multicellular gemmæ of similar character occur, also, in certain mosses (*Tetraphis*) and pteridophytes (*Trichomanes* and *Lycopodium*), while those of simpler



Thallus of *Marchantia*, showing three cupules containing gemmæ. (Original.)

structure occur in other groups, usually known under other names.

**GENEALOGIES, AMERICAN.** Unmoved by the cynical inquiry of the poet Horace as to the utility of pedigrees, and dating their researches at least as far back as the golden age of Revolutionary days, Americans have, of late years, evinced a decided inclination for that most fascinating of pursuits, genealogy. One of the chief factors so moving them has undoubtedly been the establishment of colonial and Revolutionary societies (q.v., in these Supplements). Limited as membership in these is to lineal descendants of those heroes who welded the nation in the slow fires of revolution, the anxiety to deduce a pedigree from so honorable an origin has been natural and widespread. The pioneer work was monumental, and will long survive Durrie, Savage, Chester, Waters, and the members of the New England Historical and Genealogical Society, who did it. Their researches threw valuable light on many a forgotten record, and revealed many valuable historical data upon colonial times and ways.

Representing, as the Pilgrims did, the flower of English yeomanry, with family escutcheons bright with great deeds, rather than gaudy with the trappings of discreditable nobility, some with title deeds antedating the Norman Conquest, investigation went back beyond Elizabethan days. Slowly the searchers began to publish the results of their labors. To-day hardly a distinctively American family exists which does not possess a printed record of its ancestors and their achievements. The *Bulletin* of the Boston Public Library for 1891 discloses over 1,700 family genealogies stowed among the shelves of that model institution. Records of Revolutionary days have formed the subjects of especial attention in the thirteen original states, and have been published at state or private expense. Rolls of Revolutionary soldiers, preserved in the archives of the Federal or state governments, have been searched, indexed or printed, and many books have been devoted to the deeds of heroes doomed otherwise too soon to be forgotten.

The custom of keeping careful family records has become more general, and a distinctively American method has been introduced. The old English method of making a pedigree with long lines and great waste of space has given way to a simple and closely printed statement of descent, wherein the use of different sizes and styles of type, and the judicious employment of numerals for reference purposes, have not only made the American system universal in the United States, but have insured its adoption by the English-speaking race.

Many family associations have been formed, and reunions of kinsmen at stated intervals are of frequent occurrence. An impetus has been given to the study of heraldry, and a most interesting and harmless pursuit has become one of the recreations of many a busy man's leisure moments.

The literature on the subject is varied, as well as voluminous. Nearly every public library has been compelled to respond to the frequent demands made by readers for family histories and genealogical works. The collections of the Boston Public Library,

Lenox Library in New York, and Chicago Public Library, are noteworthy and extensive.

A brief and by no means exhaustive list of standard genealogical works must include Amory's *Our English Ancestors*; Anderson's *Genealogy and Surnames* (1865); J. O. Austin's *Genealogical Dictionary of Rhode Island* (1887); Bardsley's *English Surnames*; Bergen's *Early Settlers of Kings County, New York*; Bond's *Genealogies of Early Settlers of Watertown, Waltham and Weston, Massachusetts*; C. Bridger's *Index to Printed Pedigrees* (1867); Burke's *Landed Gentry of Great Britain and Ireland*; Burnett's *Popular Genealogists*; Burn's *Parish Registers in England*; *The Clans of Scotland*; Coleman's *Index to Printed Pedigrees* (1866); Cussan's *Handbook of Heraldry*; D. S. Durrie's most valuable *Bibliographia Genealogica Americana* (1886); W. H. Egle's *Pennsylvania Genealogies* (1886); Fairbairn's *Crests of Families in Great Britain and Ireland*; Farmer's *Genealogical Register of the First Settlers of New England* (1829); Gatfield's *Books and MSS. Relating to Heraldry and Genealogy*; *The Genealogist* (1877 to date); Goodwin's *Genealogical Notes of Some of the First Settlers of Connecticut and Massachusetts* (1850); Green's *Historic Families of Kentucky* (1889); Haines's *Manual of Monumental Brasses*; Hayden's *Virginia Genealogies*; J. Camden Hotten's excellent and indispensable *Lists of Emigrants from Great Britain, 1600-1700* (1874); Hughes's *American Ancestry*, 3 vols. (1887); Littell's *Family Records of the Passaic Valley*; Lowers's *Patronymica Britannica*; Marshall's *Index to Pedigrees in the Herald's Visitations*; the same author's invaluable *Genealogist's Guide to Printed Pedigrees* (1885); *The New England Historical and Genealogical Register* (1847 to date); *The New York Genealogical and Biographical Record* (1870 to date); Nicholas's *County Families of Wales*, 2 vols.; O'Hart's *Irish Pedigrees*; Pearson's *First Settlers of Albany County, New York*; W. P. W. Phillimore's excellent work, *How to Write the History of a Family* (1887); Rupp's *Thirty Thousand Names of Immigrants in Pennsylvania, 1727-1776*; Walter Rye's *Records and Record-Searching* (1888); Savage's monument of industry, *The Genealogical Dictionary of New England*, 4 vols. (1861), and O. P. Dexter's *Index to Savage* (1884); Sims's *Index to Pedigrees and Arms in Herald's Visitations*, and his most useful *Manual for the Genealogist, etc.* (1888); Talcott's *Genealogical Notes of New York and New England Families* (1883); Tanquay's *Dictionnaire Généalogique des Familles Canadiennes*, 6 vols. (1871-88); Taylor's *Great Historic Families of Scotland*; Walford's *County Families of the United Kingdom*; H. F. G. Waters's *Genealogical Gleanings* (1885); Whitmore's *American Genealogist*, 2 vols. (1875); and Wyman's *Genealogies of Charlestown, Massachusetts*.

**GENERAL**, an officer of the general staff of an army. A commander-in-chief or lieutenant-general would, in the field, usually command several army corps, a major-general one corps or a division, and a brigadier-general a brigade. These assignments are arbitrary, and generally changed by conditions. In the British army the number holding each rank is unlimited, while in the United States the law allows of but one lieutenant-general, three major-generals and six brigadier-generals. The rank of general in the United States was created by Congress in 1866, and bestowed on General Grant; afterward conferred on Sherman, and died with Sheridan in 1891. The pay, in the United States, of a general is \$13,500 a year; lieutenant-general, \$11,000; major-general, \$7,500; brigadier-general, \$5,500.

**GENERAL ASSEMBLY.** See PRESBYTERIANISM, Vol. XIX, pp. 676 et seq.

**GENERAL BAPTISTS.** See BAPTISTS IN THE UNITED STATES, in these Supplements.

**GENERAL CONVENTION, THE,** the governing body of the Protestant Episcopal Church in the United States. This body first met in Philadelphia in 1785, as the result of a general call of delegates

from the middle and Southern states to form a union, and to agree upon some general method of government to take the place of the discipline and supervision exercised before the Revolution by the Church of England. These delegates were joined, in 1789, by the delegates from the New England states, headed by Bishop Seabury. In 1785 a constitution was adopted, substantially the same as that in use to-day. By its provisions, the general convention consists of two bodies or houses, the house of bishops, who sit in secret session, and the house of deputies, composed of four clerical and four lay delegates from each diocese. The consent of both houses is necessary to the enactment of any legislation. The senior bishop presides over the house of bishops, and the presiding officer of the deputies is elected from the body. The General Convention has power to form new dioceses, to try bishops, enact canons and to revise the prayer-book. It is convened every three years, at some appointed place.

**GENERAL THEOLOGICAL SEMINARY**, the leading educational institution of the American



GENERAL THEOLOGICAL SEMINARY.

Protestant Episcopal Church, located in New York City. This school was organized in 1817, and classes first assembled in 1819. It was moved to New Haven, Connecticut, in 1820, but returned to New York in 1822, being located (1896) between Ninth and Tenth Avenues, on Chelsea Square. In 1895 there were 14 in the faculty, 150 students and a library of 25,000 volumes. From its organization up to and including the year 1895 its graduates numbered 1,294. It has an endowment of about \$1,000,000.

**GENERATION, SPONTANEOUS.** See **ABIOTHESES**, Vol. 1, p. 49.

**GENERATIONS, ALTERNATION OF**, an interesting complication in the life-history of many plants and animals, the organism producing offspring which are unlike itself, but which in turn give rise to forms like the original parents. See **REPRODUCTION**, Vol. XX, pp. 429-431.

**GENERATOR, NEW THERMOELECTRIC.** Henry B. Cox is the inventor of a new thermoelectric generator, which is claimed to be a commercial success, and well suited to the furnishing of currents of low voltage. Machines are being built which consume 2½ feet of gas per hour, and can be arranged to deliver 1 volt and 45 amperes, or 2 volts and 22 amperes, or 11 volts and 4 amperes, etc. The ther-

moelectric couples used in these generators are subjected to the most elaborate tests in process of manufacture, in order to secure those of highest resistance. The element is built up of successive rings of the tested cast couples, and all parts are carefully insulated. Terminal wires are then brazed to the pole-pieces, and the entire element clamped in position. Another resistance-test is then taken, after which the interior is lined with a plastic cement that adheres very closely when dry and vitrified, and has practically the same degree of expansion and contraction as the integral part of the element. Then follow more resistance-tests and more cementing. A metallic jacket is used to form the exterior walls, and to complete a chamber for the water-back, as a constant supply of water has to be maintained. A bracket and gas-burner are also added, and a series of iron deflectors are used to distribute the heat evenly. A number of other thermoelectric generators have been invented within a few years, but all appear to be still in the experimental stage, or of no commercial value.

C. H. COCHRANE.

**GENESEE CANAL.** See **CANAL**, in these Supplements.

**GENESEE RIVER**, a river of western New York, which rises in Potter County, Pennsylvania, flows northward through New York and enters Lake Ontario. It is about 120 miles in length, is navigable for lake vessels for five miles, has falls at Rochester and Portageville, and its valley is a beautiful and fertile region.

**GENESEO**, a city of Henry County, northwestern Illinois, 23 miles E. of Rock Island, on the Mississippi River, and on the Chicago, Rock Island and Pacific railroad. It is a shipping-point for stock and grain, and an enterprising manufacturing town. Among the articles produced are wagons, furniture, tubs, pails, flour and agricultural implements. The Northwestern Normal School and a collegiate institute are located here. Population 1900, 3,356.

**GENESEO**, the county seat of Livingston County, central western New York, on the Genesee River, and on the New York, Lake Erie and Western railroad. It has a state normal school, a public library containing ten thousand volumes, water-works and gas. Its manufactories include those of lumber, flour, mittens and gloves, machinery and canned goods. Population 1890, 2,280; 1900, 2,400.

**GENEST OR GENET**, EDMOND CHARLES, a French diplomatist; born in Versailles, Jan. 8, 1765; died in Schodack, New York, July 14, 1834. In 1789 he was sent to St. Petersburg as *chargé d'affaires*, and in 1792 was appointed minister to the United States. He was cordially welcomed by the American people, but when he denounced the American government for remaining neutral in the troubles between France and England, and went so far as to issue commissions to privateers, ordering that their prizes should be tried and condemned by French consuls in the United States, Washington demanded and obtained his recall. Genest decided not to return to France, and was naturalized and settled in the state of New York. He married a daughter of Governor Clinton in 1794, and, later, a

Miss Osgood. He made translation of several Swedish and Norse writings: among them, a *History of Eric XIV.*

GENEVA, a city and the capital of Kane County, northeastern Illinois, on Fox River, 35 miles W. of Chicago, and on the Chicago and Northwestern and two other railroads. It has excellent water-power, which is utilized in glucose and other factories. It has a foundry and expensive school buildings. Population 1890, 1,692; 1900, 2,446.

GENEVA, a city and the capital of Fillmore County, southeastern Nebraska, 60 miles W.S.W. of Lincoln, on Turkey Creek, and on the Burlington and Missouri Valley and the Fremont, Elkhorn and Missouri Valley railroads. Grain, cattle and hogs are the principal products of the region. It has a creamery, canning factory, foundry and machine-shop. Population 1890, 1,580; 1900, 1,534.

GENEVA, a town of Ontario County, western New York, at the north end of Seneca Lake, about 16 miles E. of Canandaigua. By rail it is 26 miles W. of Auburn, and 50 miles E.S.E. of Rochester. It is situated on high ground, and is the seat of Hobart College, of the state agricultural experiment station, of Delancey Divinity School, and of Delancey School for Girls. Steamboats ply daily between Geneva and Watkins, which is about 36 miles distant, at the head of the lake. It has important optical-works, bending-works and manufactories of engines, boilers and steam-heating apparatus. Its nurseries are well known, and are very extensive, occupying about ten thousand acres, giving employment to over one thousand men, and shipping over one million dollars' worth of stock annually. Population 1890, 7,557; 1900, 10,433.

GENEVA, a village of Ashtabula County, northeastern Ohio, 45 miles N.E. of Cleveland, on the Lake Shore and Michigan Southern and the New York, Chicago and St. Louis railroads. It contains a normal school and manufactories of agricultural tools, electrical goods, mattresses and fur goods. It is in a grape-growing region, and is somewhat of a summer resort. Population 1900, 2,342.

GENEVA, a village of Walworth County, southeastern Wisconsin, on Geneva Lake, and on the Chicago and North-Western railroad. It has a ladies' seminary and a flouring-mill. The region produces much grain and some cattle. Population 1900, 2,585.

GENEVA BIBLE, also called "BREECHES BIBLE." See ENGLISH BIBLE, Vol. VIII, p. 387.

GENEVIEVE, CANONS OF SAINT. See GENEVIEVE, SAINT, Vol. X, p. 152.

GENGHIS KHAN. See JENGHIZ KHAN, Vol. XIII, p. 620.

GENII, among the ancient Romans, corresponding to the daemon of the Greeks, were protecting spirits, who were supposed to accompany every created thing from its origin to its final decay, like a second spiritual self. They belonged not only to men, but to all things, animate and inanimate, and more especially to places. The genius of an individual was represented by the Romans as a figure in a toga, having the head veiled and the cornucopia or patera in the hands, while local genii appear under the figures of serpents eating fruit set before

them. See DEMONOLOGY, Vol. VII, pp. 60-64; MANES, Vol. XV, pp. 477, 478; and PENATES, Vol. XVIII, pp. 488, 489.

GENIPAP, the many-celled edible berry of *Genipa Americana*, a West Indian and South American plant of the family *Rubiaceae*, or madders. The fruit is as large as an orange, whitish green, and with pleasant flavor.

GENOA, a village of Ottawa County, northwestern Ohio, 13 miles S.E. of Toledo, on the Lake Shore and Michigan Southern railroad. It has limestone-quarries and lumber-mills. Its manufactures are washboards, wooden bowls, stoves, barrels and hoops. It has a German and graded schools. Population 1890, 839; 1900, 824.

GENOA, GULF OF, a large indentation in the northern shore of the Mediterranean, north of Corsica. Between the towns of Oneglia on the west and Spezzia on the east, its width is nearly 90 miles.

GENOA, THOMAS ALBERT VICTOR DE SAVOY, DUKE OF, nephew of King Victor Emmanuel; born Feb. 6, 1854. After receiving an English education at Harrow School, he went through a regular course of study in the Marine College at Genoa, and came out an officer of the royal Italian navy, in which capacity he was intrusted with the command of the *Vettor Pisani*, a corvette of the first rank, bound on a voyage round the world. The vessel completed her cruise in 1880, and the Duke's journal of the voyage was published at the close of that year.

GENRE-PAINTING, a term in art originally used to indicate simply any class or kind of painting, and was always accompanied by a distinctive adjective, as *genre historique*, historical painting. It has now, however, come to be applied to scenes from familiar or rustic life especially characterized by the introduction of human figures.

GENS D'ARMES OR GENDARMES, a title, in France, originally applied to the king's horse-guards only, but afterward to all men liable to military service, and later to the body of nobles and gentry serving under the kings of France. In the present century it denotes the armed and uniformed police. They are all picked men, and are usually selected from the military forces for their courage and good character.

GENTILE DE FABRIANO. See FABRIANO GENTILE DA, Vol. VIII, p. 841.

GENTLEMEN-AT-ARMS (formerly called the GENTLEMEN PENSIONERS), the body-guard of the British sovereign, and, with the exception of the Yeomen of the Guard, the oldest corps in the British service. It was instituted in 1509, by Henry VIII, and now consists of a captain, a lieutenant, a standard-bearer, a clerk of the cheque and forty gentlemen. The pay is issued from the privy purse. Until 1861 the commissions were purchasable, as in other regiments; but, by a royal command of that year, this system was abolished, and commissions as Gentlemen-at-Arms have since only been given to military officers of service and distinction. The attendance of the Gentlemen-at-Arms is required only at drawing-rooms, levees, coronations and similar important state ceremonies. The appointment, which is in the sole gift of the crown, on the recommendation of the commander-

in-chief, can be held in conjunction with half-pay or retired full-pay, but not simultaneously with any appointment which might involve absence when the officer's services are required by the sovereign.

**GENTRY, MEREDITH POINDEXTER**, an American statesman; born in Rockingham County, North Carolina, Sept. 15, 1809; became a member of the state legislature of Tennessee in 1835, and was elected to Congress in 1839, as a Whig. Although a large slaveholder, he voted in favor of the reception of antislavery petitions. He served in the Twenty-seventh, Twenty-ninth, Thirtieth, Thirty-first and Thirty-second Congresses, and opposed the war with Mexico. After the election of Lincoln he went with the South, and sat in the Confederate Congress. He died in Nashville, Tennessee, Nov. 2, 1866.

**GENUS.** See **SPECIES**, Vol. XXII, p. 372.

**GENZANO**, a town of Italy, 18 miles S.E. of Rome, on the Appian Way. An annual flower festival, called the *Infiorata di Genzano*, is held here on the eighth day after Corpus Christi, and attracts many visitors. Population, 5,306.

**GEODES** (Gr., "earthly"), rounded hollow concretions, or indurated nodules, either empty or containing a more or less solid and free nucleus, and having the cavity frequently lined with crystals. They are sometimes called "potato-stones," on account of their size and shape. See **MINERALOGY**, Vol. XVI, p. 370.

**GEOGRAPHICAL BOTANY.** See **DISTRIBUTION**, Vol. VII, p. 286.

**GEOGRAPHIC NAMES, THE BOARD ON**, a board organized by the executive department of the United States government, Sept. 4, 1890, for the purpose of obtaining uniformity of usage in regard to geographic nomenclature and orthography, particularly in maps and charts issued by the various departments and bureaus. All unsettled questions concerning geographic names which arise in the departments are referred to this board, the decisions of which are to be accepted as the standard authority in such matters.

The Royal Geographical Society of England adopted, in 1886, the following rules, which were the same that were previously in use in the orthography of the British admiralty charts. These rules apply only to the geographical names of the countries which do not write in Roman characters. In Spanish, Portuguese and Italian names, and in the names of all other countries that use Roman characters, the native spelling will be preserved. Nor, in any case, will a change be made in the spelling of names which long usage has rendered familiar to English readers. The true native sound of the word, as it is locally pronounced by educated people, is to be taken as the basis of the spelling, without regard to the finer inflections of the accent, a reasonable approximation to the sound being all that is deemed necessary. Vowels are to receive their Italian sound, and consonants have their English pronunciation. No accent is to be used but the acute, and this only where it is demanded by a particular stress upon a syllable. Every letter is to be sounded. When two vowels come together, each should be sounded, though their pronunciation in the combinations *ai*,

*au*, *ei*, *eu*, etc., is often so rapid that they appear as one sound only. Hindu names will be accepted as they are spelled in Hunter's *Gazetteer*. The sounds of the several letters of the alphabet are as follows:

A as in *father*.

E as in *benefit* or *eh*.

I as in *seen* or English *ee*. Thus, *Fiji*, not *Fojee*, is the correct spelling.

O as in *note*.

U as in *flute*.

All vowels are shortened in sound by doubling the following consonant. The vowel is to be doubled only when there is a distinct repetition of the sound, as in *Nuulua*.

Ai corresponds to English *i*, as in *ice*.

Au corresponds to English *ow*, as in *how*.

Ao is slightly different from *au*, as in *Macao*.

Ei has the sound of the two Italian vowels, but is frequently slurred and resembles *ey* in *they*. Example, *Beirut*.

The consonant sounds are as follows:

B, D, L, M, N, P, R, S, T, V, W and Z, as in English.

C is to be always soft, but usually should be replaced by S, which it so closely resembles.

Ch always soft, as in *church*.

F as English *f*. Ph should not be used for *f*. Write *Haifong*, not *Haiphong*.

G is always hard. Soft *g* is given by *j*.

H is to be always pronounced when given.

J as English *j*. Dj should never be used for *j*.

K as English *k*. This letter should always be used for hard *c*. Example, *Korea*, not *Corea*.

Kh is the Oriental guttural, as in *Khan*.

Gh is another guttural, as in Turkish *dagh*, or *ghazi*.

Ng has two sounds—one as in English *finger*, the other as in English *singer*.

Q should never be used.

Qu is given as *Kw*. Example, *Kwangtung*.

Y is always a consonant, as in *yard*. It should never be used as a terminal, but be replaced by *i* or *e*.

**GEOMORI**, a class of Attic citizens. See **GREECE**, Vol. XI, p. 96.

**GEOPHAGISM**, the habit of eating clay or earth of any kind. People who make use of earth in their food are found in almost all parts of the globe. The Indians in the Hudson Bay region, the Ottoman Indians of South America, certain people in Lapland, West Indian blacks, and some negroes and low whites in the southern United States are more or less addicted to clay-eating. A ferruginous clay, bergmehl and a form of steatite are among the earths eaten. In Lapland bergmehl is mixed with the bread. Practicers of geophagism are known also as "clay-eaters," "sand-hillers," etc.

**GEORGE**, a division of the western province of Cape Colony, Africa, on the south coast, 220 miles E. of Cape Town. It contains two thousand six hundred square miles, and about eleven thousand inhabitants. It is valuable chiefly for its pasturage and timber. The town of George stands six miles north of the coast, and has a population of over two thousand. On the coast is the port of Mossil Bay.

GEORGE I, CHRISTIAN WILLIAM FERDINAND ADOLPHUS GEORGE, King of the Hellenes, second son of Christian IX, King of Denmark; born in Copenhagen, Dec. 24, 1845, and served for some time in the Danish navy. After the abdication of Otho I, the late King of Greece, in 1863, the vacant throne was tendered to Prince Christian, who, with the concurrence of his own family and the consent of the Great Powers, accepted and began to reign as King George I, on June 6, 1863. Since the year 1876, when active



GEORGE I.

trouble broke out in the Balkan Peninsula, King George's position has been very difficult; but as yet he has maintained it without going to war. His country gained a considerable addition of territory by the decision of the conference which followed the Congress of Berlin. In 1886, after the revolution at Philippopolis and the Servo-Bulgarian war, Greece (under a rash minister, M. Delyannis) was for declaring war against Turkey, and was stopped only by the firm attitude of England. He was married at St. Petersburg to the Princess Olga, daughter of the Grand Duke Constantine, Oct. 27, 1867.

GEORGE, HENRY, an American political economist; born in Philadelphia, Pennsylvania, Sept. 2, 1839. As a boy he was apprenticed on a sailing-vessel, went to California, and engaged in journalism there; was one of the founders of the *San Francisco Post*; in 1876 was appointed state inspector of gas-meters, and in 1879 trustee of the San Francisco Free Library. In the same year he published *Progress and Poverty*, which at once won a wide circulation and created universal



HENRY GEORGE.

interest. He went to New York in 1880, and in 1881 published *The Irish Land Question*. In the same year he visited England and Ireland, and in 1883-84 and in 1884-85 he visited England and Scotland. He made speeches which produced a marked effect on discussions of the land question. In 1886 he was a candidate for mayor of New York, on the United Labor Party ticket, receiving 68,110 votes, against 90,552 for Abram S. Hewitt, the Democratic candidate, and 60,435 for Theodore Roosevelt, the Republican candidate. He then founded the *Standard* a weekly newspaper, which he published and edited until 1890. He was also the author of *Social Problems* (1883); *The Land Question* (1884); and *Protection or Free Trade* (1886). He advocated absolute free trade, holding that the

revenues of the government should be derived solely from land, by a tax on land values; that the unearned increment of land value belonged to the state which created it. To further his theory he organized single-tax clubs in all parts of the country. In 1897 he was the candidate of the Thomas Jefferson Democracy for mayor of Greater New York, but died suddenly of cerebral apoplexy on Oct. 29th, four days before election day. His son, Henry George, Jr., was chosen to run in his father's place, but was defeated.

GEORGE, JAMES ZACHARIAH, an American soldier and public man; born in Monroe County, Georgia, Oct. 20, 1826; removed to Mississippi, served in the Mexican War, and practiced law until the outbreak of the Rebellion. He commanded a Confederate cavalry regiment during the Civil War, and in 1875 became chief justice of the state supreme court. He was elected United States Senator in 1880, 1886, and 1892. Died in Mississippi City, Miss., Aug. 14, 1897.

GEORGE, LAKE, sometimes called Lake Horicon, a beautiful sheet of water in northeastern New York, extending from southwest to northeast, 36 miles long and from 1 to 3 miles wide, 310 feet above sea-level; 400 feet is its greatest depth; it contains 300 islands, and has an outlet into Lake Champlain. On its shores stood Forts George and William Henry. It is a favorite summer resort.

GEORGES, KARL ERNST, a German Latin lexicographer; born in Gotha, Germany, Dec. 26, 1806. He studied at Leipsic and Göttingen. He published a *German-Latin Lexicon* (1882; seven editions); a *Wörterbuch der Latein-Wortformen* (1891); and a *Latin-German Dictionary* (1882; ten editions). The last-named work is regarded as the leading Latin-German lexicon of to-day. He died in Gotha, Aug. 27, 1895.

GEORGE'S CHANNEL, SAINT, the name applied to the south portion of that arm of the Atlantic which separates Ireland from Britain. At its northern extremity it is 64 miles in width, and at its southern about 62; its length from northeast to southwest is about 100 miles.

GEORGETOWN, a town and the capital of Clear Creek County, northern central Colorado, situated in a valley of the Rocky Mountains, 51 miles W. of Denver, on two branches of Clear Creek and on the Union Pacific railroad. It is in an extensive silver region, and has large reduction-works. Population 1890, 1,927; 1900, 1,418.

GEORGETOWN, a town and the capital of Sussex County, southern Delaware, on the Philadelphia, Wilmington and Baltimore railroad, 32 mile S.S.W. of Dover. Business, principally farming and canning. Pop. 1800, 1,353; 1900, 1,658.

GEORGETOWN, a town and the capital of Scott County, central northern Kentucky, 12 miles N. of Lexington, on the Cincinnati, New Orleans and Texas Pacific railroad. It is in the center of the "blue-grass country," and the business of the vicinity is farming and stock-raising. The town contains a college, two female seminaries, other schools, and has good water-power. Population 1890, 3,400; 1900, 3,823.

GEORGETOWN, a village and the capital of Brown County, southwestern Ohio, seven miles from the Ohio River, 42 miles E.S.E of Cincinnati, on the Cincinnati, Georgetown and Portsmouth railroad. It contains a woolen-mill and flour-mill. The business of the vicinity is chiefly tobacco-raising. Population 1890, 1,473; 1900, 1,529.

GEORGETOWN, a town and the capital of Georgetown County, eastern South Carolina, on Winyaw Bay, and is a terminus of the Georgetown and Western railroad. It has direct communication with New York by schooner lines, is located in a great turpentine region, and the village contains lumber and rice mills. Population 1900, 4,138.

GEORGETOWN, a town and the capital of Williamson County, southeastern central Texas, 25 miles N. of Austin, on the Austin and Northwestern railroad. The region is healthful and picturesque, and the village contains the Southwestern University. The town's manufactures are furniture, saddles, harness, plows and wood-work. Population 1900, 2,790.

GEORGETOWN, a port of entry, now incorporated in the city of Washington, District of Columbia, on the Potomac River, three miles N.W. of the capital, on the Baltimore and Ohio railroad and on the Chesapeake and Ohio canal. The heights are occupied by elegant villas, and command a fine view of the country around. Here are located a number of educational institutions, including Georgetown University (1789). Pop. 1890, 14,046; 1900, 14,549.

GEORGETOWN UNIVERSITY, an institution of learning maintained by the Jesuit order of the Roman Catholic Church, located at Georgetown, District of Columbia. It was founded in 1789, but the work of instruction did not begin until 1792. The institution was granted a charter by Congress in 1815. In addition to the regular collegiate course there are maintained a large preparatory department and schools of law and medicine. The two professional schools are established in Washington, District of Columbia. The preparatory course is connected with the collegiate work, and the two form a continuous seven years' course of study. In 1895 there were 85 instructors, 725 students and a library of 70,000 volumes. Including the year of 1894, there had graduated 2,808 students.

GEORGIA, according to the census of 1900, had a population of 2,216,329, composed of 978,357

whites, 858,815 negroes, and 181 Chinese, Japanese and Indians. The rank of the state, in the relative number of inhabitants, was twelfth. In 1890 the population was 1,837,353, the increase for the decade being within a small fraction of 21 per cent. The area of the state is 58,980 square miles, or 38,000,000 acres. The density of population is 37.5 to the square mile; the seven chief cities of the state

had but 242,362 inhabitants, or only 9.84 per cent of the population; the proportion of males and females was 919,925 of the former and 917,428 of the latter; the percentage of native and foreign born citizens was 99.34 of the former and 0.66 of the latter; the number of negroes 858,815, an increase of 133,682 in the preceding ten years. The resources of Georgia are more varied than those of any of the other Southern states. Chief among the wealth-producing industries stands agriculture. The grains, grasses and fruits of all kinds flourish, and embrace everything for the food of man and beast not tropical. The variations in soil and climate are extreme. As typified in plant-life, the banana, orange and fig find a congenial home in the southern part, and on the northern mountain peaks are found plants of the Arctic zone. The variety of products adapted to the soil and climate of Georgia was known to the original colonists, and as early as 1732, fine crops of rice, corn, peas, potatoes, pumpkins, cabbage and indigo were grown, and a silk superior to that of Italy was produced.

In January, 1895, the number and value of farm animals in the state, as estimated by the United States Department of Agriculture, were as follows: Horses 107,044, value \$5,458,470; mules 161,204, value \$10,470,828; milch cows 309,615, value \$4,811,417; oxen and other cattle 557,645, value \$4,505,380; sheep 402,946, value \$537,530; swine 1,934,892, value \$6,825,119. Total value, \$32,668,744. The estimated annual production of the principal crops is as follows: Cotton, from 800,000 to 1,100,000 bales; corn, 30,000,000 bushels; oats, 5,000,000 bushels; wheat, 3,000,000 bushels; sweet potatoes, 5,000,000 bushels; Irish potatoes, 2,500,000 bushels; rice, 35,000,000 pounds. Under the most favorable conditions the following extreme yields to the acre have been recorded: Seed-cotton, 6,917 pounds, in Washington County; corn, 137 bushels, in Spalding County; oats, 137 bushels, in Wilkes County; wheat, 65 bushels, in Dekalb County; sweet potatoes, 800 bushels, in Berrian, Crawford and Richmond counties; Irish potatoes, 420 bushels, in Wilkes County; upland rice, 100 bushels, in Early and three other counties; cane syrup, 700 gallons, in Bulloch County; clover hay, 16,000 pounds, in Dekalb County; peavine hay, 10,720 pounds, in Spalding County; corn forage, 27,130 pounds, in Greene County; Bermuda grass hay, 13,953 pounds, in Greene County; sugar, 21 barrels, in Bulloch County. Rye, barley, tobacco and sugar-cane are extensively and profitably grown, in addition to the above. The inducements to the truck-farmer are greater than in any other section of the country. The increase in this branch of agriculture has been such as to warrant the prediction that it will soon be first in importance and value. Over 100,000 acres are devoted to the culture of watermelons, requiring over 10,000 cars to carry the product to market, and the supply could be increased manifold without affecting the demand. In horticulture, Georgia stands first among the states of the South, and among the greatest producers of any section. The census reports of 1890 showed the amount of the principal orchard products (in bushels) to be as follows, for the year 1889: Apples

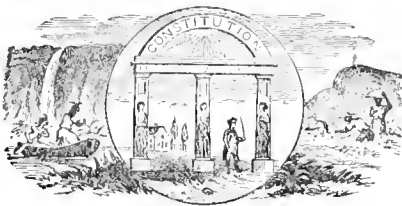

SEAL OF THE STATE OF GEORGIA.

whites, 858,815 negroes, and 181 Chinese, Japanese and Indians. The rank of the state, in the relative number of inhabitants, was twelfth. In 1890 the population was 1,837,353, the increase for the decade being within a small fraction of 21 per cent. The area of the state is 58,980 square miles, or 38,000,000 acres. The density of population is 37.5 to the square mile; the seven chief cities of the state

2,113,055; apricots, 2,233; cherries, 10,173; peaches, 1,490,633; pears, 113,868; plums and prunes, 49,668. The production for each year since that given has increased to a large extent, in peaches alone the acreage having been more than doubled. Grapes, figs, Japanese persimmons, mulberries, blackberries, strawberries, all grow prolifically and are largely cultivated, immense amounts going to the markets of the North so early as to command very high prices. In the extreme southern portion of the state, oranges, lemons, pine-apples and bananas are cultivated. Among a number of other products of the soil of Georgia are peanuts, raised in large quantities; the tea-plant, trees nearly a half-century old being found in Liberty, Talbot and other counties of the southern and southeastern portions of the state; besides quinces and other fruits of many varieties.

The timber interests of the state are extensive, and the cutting of lumber and the making of tar, turpentine and general naval stores are among the leading industries of the southern portion of the state, the annual returns from the former approximating \$18,000,000, and from the latter \$4,000,000.

In manufactures hardly a line remains unrepresented. In cotton and woollens Georgia had, in April, 1895, 73 mills, operating 668,578 spindles, 15,357 looms and 1,809 cards. Some of the mills have a capital stock of more than \$1,000,000, and the total capital invested in the plants alone exceeds \$25,000,000. In 1890 the number of bales of cotton consumed in the mills was almost 150,000, the number of employees exceeded 10,000, and the wages paid amounted to \$2,366,086. The long staple sea-island cotton of Georgia excels all other kinds grown, and its reputation is world-wide. In 1880 there was not a single cottonseed-oil mill in the state, while in 1895 there were 20 mills, paying \$1,400,000 annually for the seed used, and producing a principal product valued at \$1,800,000. In the fiscal year ending June 30th the collections of internal revenue within the state amounted to \$415,287.44. The sources were distilled spirits, tobacco, fermented liquors and oleomargarine. The tobacco factories numbered 66, the distilleries 268. Georgia is among the largest producers of commercial fertilizers, and the largest consumer. In 1890 the number of factories was 44; 1,328 laborers were employed, and wages paid aggregated \$484,889. The total value of the product was \$5,826,034. Phosphate rock is reduced to acid phosphate, cottonseed meal being largely used to supply the nitrogen. In foundry and machine shops, in the manufacture of cotton-gins and of wagons and farm implements, in canning factories and in the manufacture of clothing, in patent medicines, in printing and publishing, great advances have been made within a few years, the growth of the last-named industry from 1890 to 1896 being from an output of \$500,000 to \$3,000,000. This is but a fair index of the stimulus and growth of all lines named, as well as of many of minor importance and value.

Gold is profitably mined in northern Georgia, having been known to exist, and mined to some extent, from the time of the earliest settlements. Sin-

gle mines send annually to the United States mint over \$100,000 worth of the precious metal. About 300 men are employed in the mines of one locality, that of Dahlonega, and the industry is in every way calculated to increase. Lead, silver and copper are also found in many parts of the state, many of the minerals used as pigments, existing in large beds. Iron ores, red ores, manganese, corundum, marble, limestone, slate, mica, sandstone, tripoli, lithographic stone, zinc and tin are also found. The asbestos deposits are large and profitably worked; the coal region of the state embraces three of the extreme northwestern counties, and bauxite, the mineral ore from which aluminium is derived, has never been found in commercial quantities in the United States, except in Arkansas and in the Coosa valley, in Georgia and Alabama. Extensive deposits of this ore are constantly being discovered, and two companies are engaged in taking out the Georgia product, pronounced superior to any other

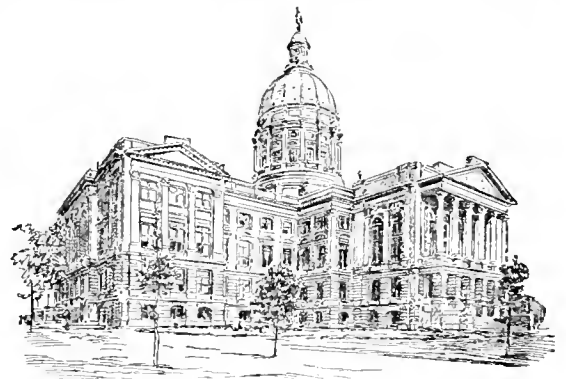

STATE CAPITOL, ATLANTA.

yet found. Fourteen miles east of the city of Atlanta is found the largest deposit of granite in the world. In a comparatively level country, solitary and alone, rising to the height of 1,686 feet, stands a solid mountain of granite, without soil, and almost bare of vegetation. The granite is admirably adapted to paving purposes, and many of the principal cities of the United States have adopted it as the standard stone, and are constantly using it. In 1880 the entire product of the state in paving-stone was \$13,000, and only ten or twelve hands were employed. In 1895 the number of employees was in excess of 1,000, and the value of the product approximated \$1,000,000. In the production of marble the state ranks second only to Vermont, the output of Georgia marble for 1894 being nearly 500,000 cubic feet.

The assessed valuations of property in the state in 1894 were: Real estate and railroad property, \$285,613,778; personal property, \$143,399,145; total, \$429,012,923. This does not include the property of railroads exempt from *ad valorem* taxation, estimated at about \$20,000,000. The tax rate was \$4.37 per thousand dollars.

The total net state debt was, in 1895, \$7,954,500, which includes the bonds of the Western and Atlantic railroad, which is the property of the state. The receipts from all sources for the same year were almost \$3,000,000.



In 1884 Georgia had but 22 banking institutions operating under the state law; in 1894 there were 118 such institutions. In 1884 the aggregate capital of the state banks was \$4,142,000; in 1894 this had increased to \$11,642,911. There were in the state, in 1884, 15 national banks, with a capital of \$2,436,000; in 1894 the number had increased to 27, with a capital of \$3,666,000. Only 14 places and 14 counties had banks in 1884, while, in 1894, 71 places and 63 counties had incorporated banks. A correspondingly large increase has been made in the number and amount of capital employed in private banks, in trust and loan companies, and in building and loan associations.

In 1894 the railroad mileage of the state was 5,102, exclusive of side-tracks and private lines. The gross earnings of the different roads for the year were \$17,208,824, as against \$8,419,626 in 1879, when the mileage was but 2,525. During a part of this period of 15 years, when the mileage and gross earnings were increased over 100 per cent each, Georgia exceeded every other state in the number of miles of railroad constructed. There has been expended for road-bed and equipment, for the different lines now in operation, over \$157,000,000, and there is a total investment of over \$172,500,000.

The school census of 1893 showed, white children 315,040, and negroes 289,931, a total of 604,971, between the ages of 10 and 18 years. The school fund for the year named was \$1,058,532.52. Schools are maintained throughout the state for five months in each year, and illiteracy is fast disappearing under the excellent system and liberal expenditure of money.

Normal schools are amply sustained by state appropriations, and all sections of the state are represented in the large attendance of teachers. In the way of higher education, the state is making rapid strides. Thirty-three colleges, universities and institutes are maintained for the white pupils of the state, while six are devoted to the needs of the negro youths, who show a high appreciation of the privileges. The State University at Athens has a large attendance, as have other institutions established by the commonwealth, and made branches of the university. The principal of these are the North Georgia Agricultural College, the South Georgia and the Middle Georgia Military and Agricultural colleges, the West Georgia Agricultural and Mechanical College, the Georgia School of Technology, the Georgia Normal and Industrial College, the State Industrial College for Colored Youth, and the State Normal School. The total enrollment of students at the institutions named is nearly two thousand. Mercer University at Macon has a large enrollment, and is very prosperous financially.

The state charitable and penal institutions are well conducted, under the most modern systems, and are liberally sustained by legislative appropriations. The State Lunatic Asylum at Milledgeville is conducted at an annual expense of about \$175,000; had, in 1894, an average of 1,709 patients, and is one of the best-conducted institutions of its kind in the South. The School for the Deaf and Dumb at Cave Spring had, in 1894, an average of 130 pupils.

The Academy for the Blind at Macon averages about one hundred inmates. The state maintains no penitentiary, but leases out the convicts, of whom there are about two thousand. Statistics of the jails, workhouses, almshouses and various benevolent institutions throughout the state make a very creditable showing, and evidence the advancement made by the people of Georgia in all matters pertaining to education and social elevation, as well as the ability of all classes to support themselves.

There are about 7,000 churches in the state, the Baptists being the leading denomination, with almost 4,000 church buildings. The Methodists come next, with about 2,500; the Presbyterians have about 200, and the Catholics 65. Other denominations are Protestant Episcopalians, Congregationalists, Disciples, Lutherans, Spiritualists and Universalists, the total church membership in the state being estimated at about 750,000.

There are 137 counties in Georgia, and newspapers are published in 129 of them. Cities, towns and villages in which papers are published number 172, of which 116 are capitals. Of the 321 papers published in the state, 27 are daily, 256 weekly, 3 semimonthly, 34 monthly and 1 bimonthly.

The principal cities and towns of the state, together with the census of 1900, are as follows: Atlanta, the capital, 89,872; Savannah, 54,244; Augusta, 39,441; Macon, 23,272; Columbus, 17,614; Athens, 10,245; Brunswick, 9,081; Rome, 7,291; Americus, 7,674; Thomasville, 5,322; Griffin, 6,857; Albany, 4,606; Marietta, 4,446; Waycross, 5,919; Milledgeville, 4,219; Gainesville, 4,382; Cartersville, 3,135; La Grange, 4,274; Dalton, 4,315. The increase in population of the cities named above within the 10 years from 1890 to 1900 was more than 60 per cent, and the population of Atlanta increased more than 37 per cent.

The following is a list of the governors of Georgia since the adoption of the United States constitution in 1788, with the years during which they occupied the office: George Walton, 1789-90; Edward Telfair, 1790-93; George Mathews, 1793-96; Jared Irwin, 1796-98; James Jackson, 1798-1801; David Emanuel, 1801; Josiah Tatnall, 1801-02; John Milledge, 1802-06; Jared Irwin, 1806-09; David B. Mitchell, 1809-13; Peter Early, 1813-15; David B. Mitchell, 1815-17; William Rabun, 1817-19; Mathew Talbot, 1819; John Clarke, 1819-23; George M. Troup, 1823-27; John Forsyth, 1827-29; George R. Gilmer, 1829-31; William Lumpkin, 1831-35; William Schley, 1835-37; George R. Gilmer, 1837-39; Charles J. McDonald, 1839-43; George W. Crawford, 1843-47; George W. B. Towns, 1847-51; Howell Cobb, 1851-53; Herschel V. Johnson, 1853-57; Joseph E. Brown, 1857-65; James Johnson, 1865; Charles J. Jenkins, 1865-67; Gen. T. H. Ruger, 1867-68; (military governor, see GEORGIA, Vol. X, pp. 434-438); Rufus B. Bullock, 1868-72; James Milton Smith, 1872-77; Alfred H. Colquitt, 1877-82; Alexander H. Stevens, 1882-83; Henry D. McDaniel, 1883-86; John B. Gordon, 1886-90; William J. Northen, 1890-95; William Y. Atkinson, 1895.

GEORGIA, GULF OR STRAIT OF, a body of water

between southwestern British Columbia and Vancouver Island. Its length is about 120 miles; width, from 10 to 20 miles. It contains many islands, and is connected with the Pacific Ocean by Queen Charlotte Sound on the north and the Strait of Juan de Fuca on the south.

GEORGIA, UNIVERSITY OF, a non-sectarian educational institution for men only, located at Ath-

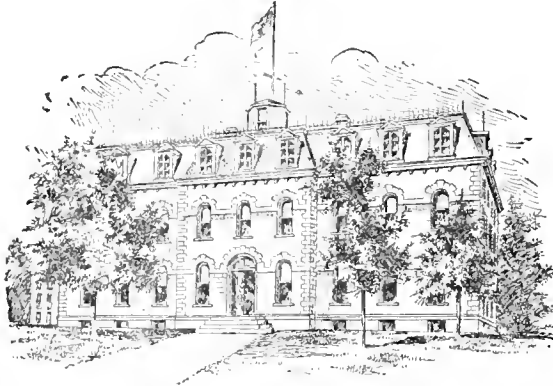

GEORGIA UNIVERSITY BUILDING.

ens, Georgia, and founded in 1785. All of the state educational institutions are included under the title University of Georgia, and include the normal school; five agricultural colleges; schools of law, technology and medicine; and the school of liberal arts, known as Franklin College. Women are conditionally admitted to the classes of the agricultural departments. A tuition fee is charged in the professional schools, but instruction is free in all others. In 1895 there were at the College of Liberal Arts 20 instructors, 237 students and a library of about 25,000 volumes. The same year the total attendance at the whole university was 1,542.

GEORGIAN BAY, the northeastern part of Lake Huron, in the province of Ontario, Canada. It is partly separated from the rest of the lake by a peninsula called Cabot's Head, and by the Great Manitoulin Island. It is about 120 miles long and 50 miles wide.

GEOTROPISM, a term in plant-physiology applied to the effects of the stimulating directive action of gravity. Geotropism is *negative* when its action results in directing a member in a direction opposed to that of the action of gravity, as in the case of primary stems; it is *positive* when it results in directing a member in the same direction as that of the action of gravity, as in the case of primary roots. This action of gravity has nothing to do with the weight of parts, but is a stimulus, affecting irritable regions of tissue. See DIAGEOTROPISM, in these Supplements.

GEPHYRÆA. See ANNELIDA, Vol. II, p. 70.

GERANOMORPHÆ, a family of birds, established by Huxley, composed of the cranes and rails. The group is nearly equivalent to the groups *Alecto-*  
*rides*, *Gruioideæ* and *Paludicolæ* of other authors.

GERBILLE, a name applied to rodents of the subfamily *Gerbillinae*, in the rat family (*Muridae*). The gerbilles somewhat resemble the ordinary rats. They are remarkable for their long hind limbs,

which enable them to progress rapidly by jumping. Their dwellings are underground burrows, in which they store quantities of food. The gerbilles are most numerous in Africa, but some are found in southern Asia and Europe.

GERFALCON OR GYRFALCON. See FALCON, Vol. IX, p. 3.

GERKI, a town of the Sokoto country, in the Soudan, Africa, at about lat. 12° 40' N., long. 9° W. It is surrounded with walls, and is noted for the thievishness and laziness of its inhabitants, who are chiefly Fulahs and Mohammedans. Population, 15,000.

GERMAIN, ANTOINE HENRI, a French statesman; born at Lyons, France, Feb. 19, 1824; founded the Crédit Lyonnais, of which he was chairman. In 1869 he entered the National Assembly as a Liberal, acting with the Left Center, and became recognized as a high authority on financial questions, opposing the financial policy of the republic. He published a number of works on political economy and finance; among them, *The Financial Situation of France in 1886* (1886) and *Parliamentary Finances* (1885).

GERMAN EAST AFRICA AND GERMAN WEST AFRICA. See AFRICA, in these Supplements.

GERMANIUM, a metallic element discovered in 1885 by Dr. Winckler in a silver ore, argyrodite, of which it forms about six per cent; symbol, Ge; atomic weight, 72.3. It has a melting-point about 1650° F. (900° C.); is oxidized when heated in air; crystallizes in octahedra; has a perfectly metallic luster, and is of a grayish white color. The new metal was named after Germany. Fifteen years before its discovery its existence was asserted by Mendeleëff.

GERMANO, SAN, a beautiful and prosperous town of Italy, situated at the base of Monte Casino, in the province of Terra di Lavoro, about 50 miles N.N.W. of Naples. It contains handsome public edifices, and is surrounded by the remains of monuments and buildings of high antiquarian interest; it is built on the site and from the ruins of the ancient Volscian town Casinum, or Casca. The district of San Germano is highly cultivated and beautiful. Population, 8,766. See MONTE CASINO, Vol. XVI, p. 778.

GERMAN SOUTHWEST AFRICA. See AFRICA, in these Supplements.

GERMANTOWN, a former borough of Pennsylvania, included since 1854 in the limits of Philadelphia, forming the twenty-second ward. Here an attack by Washington, on the British camp, in the early morning of Oct. 4, 1777, was repulsed, the Americans losing 1,000 men, the British 600. Population included in that of Philadelphia city.

GERMANY. For the geography, history, productions, government, language, literature and earlier statistics of Germany and German states, see Vol. X, pp. 447-547. The following statistics are obtained from the latest government reports, and all figures are, in general, those of the 1895 budgets.

*Population.* The following are the official fig-

ures giving the returns for Dec. 1, 1890, and Dec. 2, 1895:

STATES OF THE EMPIRE.	POPULATION, Dec. 1, 1890.	POPULATION, Dec. 2, 1895.
Prussia (with Heligoland).....	20,057,307	31,855,123
Bavaria.....	5,504,082	5,818,544
Württemberg.....	2,030,522	2,081,151
Baden.....	1,057,807	1,725,464
Saxony.....	3,502,084	3,787,688
Mecklenburg-Schwerin.....	578,342	597,430
Hesse.....	902,883	1,030,020
Oldenburg.....	354,008	373,739
Brunswick.....	403,773	434,213
Saxe-Weimar.....	320,001	339,217
Mecklenburg-Strelitz.....	97,078	101,540
Saxe-Meiningen.....	223,832	234,005
Anhalt.....	271,003	293,208
Saxe-Coburg-Gotha.....	200,813	210,603
Saxe-Altenburg.....	170,804	180,313
Lippe-Detmold.....	128,495	134,854
Waldeck.....	57,281	57,709
Schwarzburg-Rudolstadt.....	85,863	88,685
Schwarzburg-Sondershausen.....	75,510	78,074
Reuss-Schleiz.....	119,811	132,130
Lippe-Schaumburg.....	39,163	41,224
Reuss-Greiz.....	62,754	67,405
Hamburg.....	622,530	681,932
Lübeck.....	76,485	83,324
Bremen.....	180,443	196,304
Alsace-Lorraine.....	1,603,506	1,649,680
Total.....	40,428,470	52,270,601

Of the total population in 1895, 49.9 per cent lived in towns of 2,000 inhabitants or more, an increase of 8.3 per cent over 1885. The most recent occupation census gives the number of persons in the empire engaged in agriculture and cattle-raising as 18,068,663, out of a total of 51,770,284; in forestry, hunting, and fishing, 432,664; in mining, metal-works, etc., 20,253,241; in trade and commerce, 5,966,846; in domestic and other service, 886,807; in the professions, 2,835,014; without occupation or profession, 3,327,069. Of the 486,190 persons of foreign birth resident in Germany, Dec. 2, 1895, the nationalities were as follows:

Austria and Hungary.....	222,052
Russia.....	20,559
Netherlands.....	59,743
Switzerland.....	44,875
France.....	10,610
Denmark.....	28,140
Great Britain and Ireland.....	15,299
Sweden and Norway.....	11,001
Luxemburg.....	11,755
Italy.....	22,093
Belgium.....	8,047
Other European countries.....	3,316
United States.....	15,788
Elsewhere.....	4,416

The great majority of German emigrants sail from German ports and Antwerp. In 1897 the total number of emigrants, excluding those who sailed from French ports, was 23,220. From 1820 to 1897 the number of emigrants to the United States was 5,250,000. There are in Germany 28 cities of over 100,000 inhabitants. Their populations on Dec. 2, 1895, were:

Berlin.....	1,077,304
Hamburg.....	625,552
Munich.....	407,897
Leipsic.....	399,083

Breslau.....	73,169
Dresden.....	336,440
Cologne.....	324,504
Frankfort-on-the-Main.....	220,279
Magdeburg.....	214,424
Hanover.....	209,535
Düsseldorf.....	175,685
Königsberg.....	172,706
Nuremberg.....	162,386
Chemnitz.....	161,017
Stuttgart.....	158,321
Altona.....	148,044
Bremen.....	141,894
Stettin.....	140,724
Liberafeld.....	139,337
Strasbourg.....	135,608
Charlottenburg.....	132,377
Barmen.....	126,002
Dantzic.....	125,605
Halle-on-the-Saal.....	116,304
Brunswick.....	115,138
Dortmund.....	111,232
Aachen.....	110,551
Krefeld.....	107,245

*Area and Agriculture Products.* The total area of the empire in 1895 was 208,830 square miles. According to the census of 1893, 91 per cent of the total area was productive, the principal crops being wheat, rye, barley, hay, oats, and potatoes. The heaviest yields are of potatoes and hay; rye, oats, wheat, and barley coming next in order. Beetroot (both sugar and fodder) is now largely grown, and, manufactured, has become a profitable industry. In 1893 about 26 per cent, or 34,347,000 acres, was in forest, from which domains Prussia alone receives a revenue of \$20,000,000. In the various states of the empire there were, in 1897, eighteen and a half million cattle, fourteen million swine, eleven million sheep, three million goats, and four million horses.

*Mining and Manufactures.* Marvelous has been the development, in recent years, of German manufacturing industries, and the consequent expansion of her commerce. This is in part due to the mining wealth of the country, and to the activities of her people in raising it and turning it to account. The value of the minerals, chiefly coal and iron ore, raised in Germany and in the Grand Duchy of Luxemburg in the year 1898, was close upon \$235,000,000. The chief seats of the German iron manufacture are in Prussia, Alsace-Lorraine, Bavaria, and Saxony. Steel is made in Rhenish Prussia. Saxony is the leading state in the production of textiles, but Westphalia and Silesia also produce linen; Alsace-Lorraine, Württemberg, and Baden produce cotton goods. Woolens are manufactured in several Prussian provinces; silk in Rhenish Prussia, Alsace, and Baden. Beetroot sugar is an important manufacture in Prussia, Brunswick, and Anhalt; glass, porcelain, and earthenware in Silesia, Thuringia, and Saxony; clocks and woodenware in Württemberg and Bavaria; and beer in Bavaria and Prussia.

The total value of the productions of the foundries of all kinds in the empire was, in 1897, in the neighborhood of \$132,050,000. Of finished iron there was produced in the same year nearly eight million metric tons, of the value of 252 million dollars. This output came from 1,506 establishments producing finished iron, including steel works. This trade, in its various stages, gave

employment during the year (1897) to 241,787 men, besides 37,991 iron-miners. Coal and lignite mining gave employment to 376,231 hands. The fisheries, deep sea and inland, engaged 32,199 persons; the exports, in 1898, of fresh fish was valued at over one and a half million dollars. In 1897-98, the number of breweries was 7,542, and the output for the year was close upon fifteen thousand million gallons. The average annual beer consumption, per head of the population, has been for the past twenty years 22 gallons. In 1897-98, there were besides 60,779 distilleries in operation.

*Railways, Shipping, and Ship Construction.* Of recent years German shipbuilders have won great triumphs, especially in the construction and plying of the mammoth ocean liners that cross the Atlantic. In such magnificent vessels as the *Kaiser Wilhelm der Grosse* and the *Deutschland*, Germany is surpassing, for power and speed, both English and American shipbuilders, and making great strides towards the monopoly of the ocean passenger trade of the better class. In this respect, the enterprise of the Hamburg-American Steamship Co. and of the North German Lloyd Co., are to be commended. Germany's merchant navy, including both steamers and sailing vessels, now (1899) numbers 3,713 ships, with a net tonnage of 1,639,552; the number of sailors of the merchant navy employed was, in 1899, 43,146. The total length of the canals in the empire was, in 1897, 1,452 miles, including the Kaiser Wilhelm canal, connecting the North Sea and the Baltic, 61 miles in length. This canal, which cost nearly 40 million dollars to build, was opened for traffic in June, 1895. It has a depth of 29 ft. 6 in. There is also a project on foot, though temporarily blocked in the Prussian Landtag, to construct a canal to connect the Elbe with the Rhine, utilizing, in part, the present Dortmund-Ems canal. In 1899 there were 31,150 miles of railway, almost wholly owned by the imperial or state governments, completed and open for traffic throughout Germany. The empire had, in 1898, 76,418 miles of telegraphs in operation.

*Education.* Education in Germany is general and compulsory, the school age being from six to fourteen. The total number of children of school age, in 1890, was 8,604,887. The number of elementary schools, in 1891, was estimated at 56,560, with about 7,925,000 pupils and 120,000 teachers. In 1895 the number of secondary schools, including the gymnasia, realschulen, etc., was 986. There are 21 universities in the empire, the theological faculties in most of which being Protestant. The notable institutions are Berlin, Leipzig, Bonn, München, Breslau, Göttingen, Strasburg, Halle, Heidelberg, Tübingen, Königsberg, Kiel, Freiburg, and Jena.

*Department of Justice.* In terms of judicature acts in 1877 and 1879, a uniform system of law courts was adopted throughout the empire not later than Jan. 1, 1879, though, with the exception of the Reichsgericht, all courts are directly subject to the government of the special state in which

they exercise jurisdiction, and not to the imperial government. The appointment of the judges is also a state, and not an imperial, function. The empire enjoys uniform codes of commercial and criminal law; a uniform code of civil law was adopted and came into force in 1900.

The lowest courts of first instance are the *Amtsgerichte*, each with a single judge, competent to try petty civil and criminal cases. There were, in 1895, 1,924 *Amtsgerichte* in the empire, or one for every 25,690 inhabitants. The *Landgerichte* exercise a revising jurisdiction over the *Amtsgerichte*, and also a more extensive original jurisdiction in both civil and criminal cases, divorce cases, etc. In the criminal chamber five judges sit, and a majority of four votes is required for a conviction. Jury courts (*Schwurgerichte*) are also held periodically, in which three judges preside; the jury being 12 in number. There are 172 *Landgerichte* in the empire, or one for every 287,374 of the population. The first court of second instance is the *Oberlandesgerichte*. In its criminal senate, which also has an original jurisdiction in serious cases, the number of the judges is seven. There are 28 such courts in the empire. The total number of judges on the bench in all the courts above mentioned is 7,601. In Bavaria alone there is an *Oberste Landesgericht* with 18 judges, with a revising jurisdiction over the Bavarian *Oberlandesgerichte*. The supreme court is the *Reichsgericht*, which sits at Leipzig. The judges, 84 in number, are appointed by the emperor on the advice of the *Bundesrath*. The court exercises an appellate jurisdiction over all inferior courts, and also an original jurisdiction in cases of treason. It has four criminal and six civil senates.

*Government.* The German empire is a confederation of German States under the presidency of the emperor (William II, of Hohenzollern, King of Prussia). The government is administered under the act of 1871, as described in Vol. X, p. 463. Under that law the legislative period was three years. By the law of March 19, 1888, the duration of the legislative period was extended to five years; this law came into force in the legislative period beginning in 1890. The legislative functions of the empire are vested jointly in the Reichstag (397 deputies) and the *Bundesrath*, or Federal Council (58 members), both of which meet in annual session, convoked by the emperor. The *Bundesrath* represents the individual States of Germany, while the Reichstag represents the German nation. The presiding officer of the former is the chancellor of the empire (resigned, 1900) Prince Hohenlohe-Schillingsfürst. The chief officer of the Reichstag is the president of the body, who is elected by the deputies. The minister in charge of foreign affairs is (1900) Count von Bülow.

*The Imperial Secretaries* of state number 12, including the Chancellor. They do not form a "cabinet," but act independently of one another, under the general supervision of the Chancellor. They are the executive heads severally of the imperial departments, *viz.*: Foreign Affairs; Home Office; Admiralty; Ministry of Justice; Treasury;

Post-Office; Railways; Exchequer; Invalid Fund; Imperial Bank; Debt Commission. Salary of each of the department secretaries \$9,000.

*Political Parties.* The Reichstag being the focus of German political life, it may be well here to note the political complexion of the body as the result of the last general election (in June, 1898). In that election the strength of the various parties (some twelve in number) was as follows: Centre, or Clerical party, 103; Social Democrats, 56; Conservatives, 53; Free Conservatives, 21; National Liberals, 48; Advanced Radicals, 30; Moderate Radicals, 13; Poles, 14; Anti-Semites, 12; South German People's Party, 8; Agrarians, 5; and a miscellaneous group of Hanoverian Guelphs, Alsations, Bavarians, and others. Compared with previous parliaments, the Social Democrats, in the 1898 elections, made considerable gains; but the Centre were, with its voting allies, still left with the balance of power in their hands. The total number of qualified electors was officially returned at 11,200,000, and of voters 7,600,000, or about 67 per cent. Of the important measures discussed by the Reichstag during the recent sessions, the chief was the army bill, which came near bringing on a political crisis in the country. An agreement, which was really a compromise, was finally come to (March, 1899), which will permit the effective strength of the army, within the coming five years, to reach 495,500 men, on a peace footing. The anti-strike bill, designed to suppress and punish the agitators and promoters of strikes, was another disturbing measure, which was finally thrown out of the House, the Liberals and Social Democrats both strongly opposing it. Another contentious matter, though finally agreed to, was the bill to extend for 20 years the privileges of the Imperial Bank in regard to regulating the discount rates of private banks of issue.

*Colonies and Dependencies.* The last sixteen years have seen Germany put forth great effort to acquire abroad protectorates, dependencies, and what in diplomatic jargon is termed "spheres of influence." Colonies, in the English sense of the term, they can hardly be said to be; but they may yet attain to that status, and in the meanwhile they are tributary to her now large and rapidly advancing foreign commerce. Their field is confined to Asia and Africa, including in the latter German Southwest and East Africa, Togoland, situated on the Slave Coast, and the Kamerun region, with a coast line of 200 miles on the Bight of Biafra. Her Asian possessions proper are the port and district of Kiau-Chau, on the east coast of the Chinese Province of Shan-tung, which in 1897 was seized by Germany and transferred to it by treaty in the following year. The area of the protectorate is about 200 square miles, exclusive of the bay. Within 100 miles of the port are extensive coal fields, which, by agreement, are to be worked by German capital. The other dependencies of the empire are situated in the Pacific, or, more technically, in Micronesia and Oceania. They include, in the latter, the islands of Savaii and Upolu, the largest of the Samoan or Navigator group. These

possessions, in 1899, were acquired under an Anglo-German agreement, accepted and ratified by the United States, which at the same time secured Tutuila and other of the Samoan island group. The German dependencies in the Pacific embrace Kaiser Wilhelm's Land, Bismarck Archipelago, and the Solomon, Marshall, Caroline, Palaos (Pelew), and Marianne islands. The territorial area of the African and Asiatic dependencies of the empire is over a million square miles, with an estimated total population of between 14 and 15 millions. Their affairs are administered by imperial governors, commissioners, and deputy commissioners. Those in Africa have already a large export trade, chiefly of palm oil, caoutchouc, cacao, gum, copra, and ivory. The Pacific island protectorates produce, besides coffee, cotton, and tobacco, a variety of valuable timber, such as ebony, sandal wood, and bamboo. Among other of the island products are tortoise-shell and mother-o'-pearl, together with copra, the dried kernel of the cocoanut, from which a valuable oil is expressed.

*Finance and Commerce.* The revenues of the empire are derived from customs and excise levies, from the profits of the postal, telegraph, and State railway systems, and from federal contributions by the individual States. The revenue for the fiscal year, 1899-1900, was \$381,547,000, and the expenditure \$387,920,000. At the end of March, 1898, the total funded debt amounted to \$545,560,000, and the unfunded debt to \$30,000,000. The latter is represented by imperial treasury bills. The funded debt bears 3 and  $3\frac{1}{2}$  per cent. interest. As a set-off to the debt of the empire there exists a variety of invested funds, such as the fund for invalids, which at the above date amounted to \$103,000,000. The war treasure fund, \$30,000,000 in amount, is not invested, but preserved in gold at Spandan.

The imports for the year 1898 were in value \$1,359,919,000, while the exports amounted to a little more than a thousand million dollars. The chief exports of the empire are of coal and coke, beet sugar, woolen fabrics, mixed silk and cotton cloth, hosiery, hats, drapery goods, and small wares, paper, leather goods, and aniline dyes. The chief imports consist of wheat, rye, barley, horses, raw hides, raw silk, raw cotton, wool, coffee, petroleum, etc. Since 1879 Germany has been protectionist in her commercial policy. The duties levied in 1898 amounted in value to \$128,831,000, or 18.1 per cent. of the value of the imports subject to duty.

*The Army.* A further increase of the German army was effected by a reorganizing act, which came into force Oct. 1, 1899. The army on a peace footing consists now (1900) of 23,730 officers and 572,699 men, including paymasters, veterinary officers, armorers, and saddlers, with 120,000 horses and 2,000 guns. On a war footing, Germany is prepared to place more than 4,000,000 trained men in the field, fully armed. No official statement respecting the army is issued, and therefore the above figures are to some extent estimates. Under the new military law of 1899 there will be, at the

end of 1902, 625 battalions of infantry, 482 squadrons of cavalry, 574 batteries of field artillery, 38 battalions of foot artillery, 26 battalions of pioneers, 11 battalions of army service troops, and 23 battalions of train. The length of service in the standing army is six years, two of these with the colors in the infantry, and three in the cavalry and horse artillery, and the remainder of the six years in the reserve. After quitting the reserve of the active army the soldier passes five years in the Landwehr and seven in its reserve. A new quick-firing field gun has just been provided for the artillery, by which the German gunners expect to be able to fire at least five aimed rounds a minute. Germany has 17 fortified places of the first class, serving as fortified camps, and 19 other fortresses. The infantry is armed with the Mauser rifle, of the 1888 model, with five cartridges in the magazine, and having a calibre of 7.864 millimetres. The army is divided into the Corps of Guards and 22 army-corps, the latter being subject to five so-called *Armee-Inspectionen*. The fortified places are all connected with each other by means of underground telegraphs, while strategical railway lines lead from the principal military centres toward the frontiers.

*The Navy.* The imperial navy was reorganized in 1889. The chief command was separated from the administration and vested in a naval officer, while the immediate direction of affairs was transferred to the Reichsmarineamt, having at its head, under the Chancellor, the naval Secretary of State. The naval officer has to do with the training and efficiency of the *personnel*, etc., while the Secretary of State deals with dockyards, arsenals, supplies, etc. Germany has two ports of war—Kiel and Wilhelmshaven, the one on the Baltic, the other on the North Sea, connected, since June, 1895, by the Kiel canal. The year 1898 was an important one in the history of the German navy, as it marked the beginning of a definite shipbuilding policy and programme, despite the opposition of an unwilling Reichstag. The policy then foreshadowed was that Germany should possess 24 battleships, 32 various cruisers according to class, 11 despatch vessels, 4 gunboats, and 113 torpedo-boats. The policy at length formulated in the decision to build seven battleships in the first three years, and five in the second three. On the launching (Oct., 1899) of the *Kaiser Karl der Grosse*, the Emperor hinted at a further programme, which would give the empire three new battleships every year for six years. These will be of the *Brandenburg* and of the *Beowulf* class, and on them great defensive and offensive power will be wrought. The new armored cruisers are of 10,000 and 11,000 tons displacement. They are the *Fürst Bismarck*, and *Kaiser Wilhelm der Grosse*, while the new protected cruisers are the *Freya*, *Hertha*, *Victoria Luise*, *Hansa*, *Vineta*, and the *Gazelle*. The growth of the empire in military and naval strength, it will be seen, is keeping pace with its industrial and commercial expansion. In 1899-1900, the navy consisted of 16 battleships, 19 port-defence ships, 21 cruisers, 4 torpedo

gun boats, and 138 torpedo craft. The *personnel* for 1899-1900 consisted of 1,118 executive officers, 5,193 petty officers, 142 surgeons, 1,119 warrant officers, and 19,679 men and boys. The sailors of the fleet and marines are raised by conscription from among the seafaring population, who, on this account, are exempt from service in the army. The total seafaring population of Germany is estimated at eighty thousand, of whom forty-eight thousand are serving in the merchant navy at home and six thousand in foreign navies. Germany subsidizes, as auxiliary merchant cruisers, seven vessels, four of the Hamburg-American Steamship Company and three of the North German Lloyd Company.

*HISTORY.* The history of modern Germany ends in Vol. X, p. 514, with the departure from Berlin of Prince Bismarck, who, unable to endure the thought of being ruled instead of ruling, had resigned the Chancellorship, and now retired to private life at Friedrichsruhe, whence he was to view, in exile, the coming dissensions within the state, and realize that, although he had been its creator, his help was no longer necessary to the continuance of the German Empire. April 15, 1890, Emperor William II announced to the Reichstag the appointment of General Leo von Caprivi de Caprera, one of the great generals of the war of 1870, to succeed Bismarck as Chancellor and Premier of the Council. The general feeling that Bismarck's retirement would be an impediment to the national growth and prosperity of the empire was without foundation. Caprivi announced his plan to continue so far as possible the government principles of Bismarck. The official press, however, was discontinued, an action which was, on the whole, favorably received. During the years 1890-91 the International Labor Congress for the betterment of the laboring classes of European countries was held in Berlin; the Samoan treaty with the United States ratified; the triple alliance extended for three years; and the beginning of the imperial agitation for an increase in the army was begun. The celebration of the anniversary of the birth of Count Von Moltke was followed shortly, April 24, 1891, by the death of the great strategist. April 1, Bismarck's birthday was a time of great rejoicing, and marked by a note of congratulation by the Emperor. Strained relations were said to exist between the Emperor and the "Iron Chancellor," and this act of the Emperor was greeted with approval as indicating a rapprochement. Probably the most significant event in 1891 was the Emperor's visit to various foreign countries, particularly to England and Russia. His cordial reception in both countries tended to establish existing friendly relations more firmly. August 10th of the same year, the twentieth anniversary of the restoration of the empire was celebrated with befitting national festivities. September 21st witnessed the relaxation of the severe passport regulations applied in Alsace-Lorraine. Emperor Wilham II had conducted himself in a manner entirely different from that expected by the Liberals and socialists. While

supporting monarchy and military power, he had shown a strong disposition to rule in the interests of the people. Early in 1892 he advocated the passage of a primary education bill, making religious instruction compulsory in the elementary schools of Prussia, in order to prevent children from growing up atheists. This bill excited intense opposition from all parties, and was withdrawn. The most significant political act of the year was the affront given Bismarck by the Emperor of Austria in refusing the ex-Chancellor an audience. The occasion was the visit of Bismarck to Vienna at the time of the marriage of his son, Count Herbert Bismarck, June 21, 1892, when the strained relations of Bismarck and Emperor William II prevented the Austrian emperor from recognizing Bismarck other than as a private citizen. This affront was resented by Bismarck, and attributed by him to the influence of Emperor William. Upon his return to Germany, in several published interviews Bismarck so severely criticised the Emperor as to cause an outburst of public reproach from the Conservatives, and talk of treason. Thus the breach between the Emperor and Bismarck was widened.

In 1892 the "Guelph fund," which had been the occasion of much Parliamentary debate and strife among the leaders, was turned over to the Duke of Cumberland. This fund consisted of about \$12,000,000, and represented the value of the estates of the King of Hanover, which were confiscated as a result of the battle of Langensalza, June, 1866. By an act in 1873 this fund was to be restored to the King as soon as he renounced all claim to Hanover. This the King refused to do during his life, and his claim descended to the Duke of Cumberland, who finally renounced his claim to Hanover and received the accumulated fund. During the first half of the year 1893, the whole empire was agitated by the discussions of the army bill, which, as put forward by the government, demanded additional taxation and increased numbers of recruits. The strongest opposition felt by the Emperor since his accession was developed. Amendment after amendment was defeated, and finally the whole bill refused by the Reichstag, May 6th. Emperor William immediately dissolved the Reichstag and called a new election. The new body was, by a small majority, in favor of the government, and July 15th the bill was passed. A convention of finance ministers of the various states was called at Frankfort, to consider means for carrying out the provisions of the bill. December 1st was marked by the repeal of the decree against the Jesuits, which expelled the members of that order from the empire in 1873. The year ended with the various political parties in a state of disruption over commercial treaties, but with the government in a stronger position than at its beginning. The reconciliation of the Emperor William and Bismarck, January 20th, was an auspicious beginning for 1894. Bismarck, by invitation of the Emperor, paid the latter a visit in Berlin. This was the signal for popular rejoicing, which was renewed on February 19th, when

the Emperor returned the visit. October 26th, Chancellor Caprivi resigned his office as the result of a disagreement between the Emperor and himself in regard to methods of repression of the socialists. Caprivi favored moderation, while the Emperor inclined towards suppression. The majority of the Council, the Agrarians and Bismarck sided with the Emperor, and the only course open to Caprivi was retirement. Prince Hohenlohe-Schillingsfürst, governor of Alsace-Lorraine, was appointed to the Chancellorship. With his ministry came the revival of many questions, which during Caprivi's government were suppressed. Prominent among these questions were the anti-revolutionary measures against socialists, anarchists, etc. A general national quiet, however, coming from the change in ministers, prevailed during the remainder of the year. The only break occurred when, at the opening of the Reichstag, December 5th, in the new Parliament house, cheers for the Emperor were proposed by the Chancellor and refused by the socialists, an act considered by many treasonable. An effort was made to indict the offending members, but the movement was not approved in the House,— a sign of the growing toleration of free speech and action. The new Parliament building is the finest structure in the empire. It was erected at a cost of over \$7,000,000. The corner-stone was laid in 1884 by Emperor William I. In January, 1895, the anti-revolutionary bill was rejected by the Reichstag. April 1st, the eightieth birthday of Bismarck was celebrated by the whole nation, delegations from all parts of the empire paying their respects. June 19th the Kiel canal, known officially as the Kaiser Wilhelm canal, was formerly opened in the presence of representatives of the governments of the world. This canal connects the Baltic and North seas, and was constructed at a cost of over \$39,000,000. On Aug. 18, the 25th anniversary of the surrender of the French at Sedan was celebrated. The last quarter of 1895 was marked by the retaliatory measures against the United States for the duty placed by the latter on German sugar. Prohibitive acts were put in force against American beef, and American insurance companies were debarred from doing business in Germany. Jan. 18, 1896, the 25th anniversary of the founding of the empire, was celebrated as a national holiday.

During the five years following the resignation of Bismarck, great internal improvements were effected. The international relations were strengthened; the military power was enforced and the navy reorganized; the German possessions in Africa were more clearly defined by treaties with France; and the state, as a whole, grew and prospered.

During the session of 1899 sharp contests took place between the government and the Agrarians in the Reichstag, partly over canal schemes, and partly over the Emperor's special measure for the restriction of strikes. The latter measure was thrown out of the Chamber. The bill sanctioning expenditure on the canal to connect the Rhine and the Elbe was finally agreed to. During the year the Dortmund-Ems canal was completed and

opened for traffic (Aug., 1899). The canal, which has a length of 160 miles, cost \$20,000,000 to construct. A bill submitted in the Reichstag to increase the peace strength of the army evoked much discussion and considerable opposition. It was finally passed, however, the government being conceded most of its demands. In November, the programme of increased naval construction came before the Chamber. By the measure it was proposed in the early years of the new century, to nearly double the efficiency of the German navy. The government's wishes in this respect were in the main adopted. The renewal of the Imperial Bank charter for a time created a division in the House, but was at length agreed to. The treaty with Spain was also endorsed by the Reichstag for the acquisition of the Caroline, Pelew, and Ladrones islands in the Pacific. The cost of the acquisitions was 25 million francs. The protracted wrangling over the succession to the throne of Lippe-Deilmold was settled during the year.

In Oct. 1900, Germany and Great Britain formed what may be termed an alliance on the Chinese question. The compact provides for agreement in policy and concerted action by the two Powers in present conditions and in all prospective contingencies, whether any other Powers shall adopt a similar policy or not, and in case any other shall adopt and pursue an antagonistic policy these two nations "reserve to themselves the right to come to a preliminary understanding regarding the eventual step to be taken for the protection of their own interests." The terms of the policy include, first, the open door, which is to be maintained in China for the benefit of all countries without distinction; secondly, that neither Power shall aggress on the territorial integrity of the Chinese empire or sanction partition of it by any other Power; and thirdly, that if any other Power seeks to close the open door or to violate the integrity of Chinese territory, Britain and Germany will act together as may seem best to meet the exigencies of the case. The United States, it is understood, regards with satisfaction the compact between these two great Powers. G. M. A.

**GÉRÔME, JEAN LÉON**, a French historical painter; born at Vesoul, Haute-Saône, May 11, 1824. While studying at the *École des Beaux-Arts*, Paris, he also enjoyed the instruction of the celebrated Delaroche, with whom he went to Italy in 1844, and there exhibited his first picture, *A Cockfight*, which brought him a third-class medal. Gérôme traveled in the East in 1853, and often returned there for subjects for his canvases. His picture, *The Age of Augustus*, was purchased by the French government in 1855. In 1863 he was made a professor of painting at the *École des Beaux-Arts*. Many



JEAN L. GÉRÔME.

of his works are well known through reproductions. Among them are *Cæsar and Cleopatra*; *Slave Market in Rome*; *The Promenade of the Harem*; *Bacchus and Cupid*; *Greek Interior*; *The Gladiators*; and *Chariot Race*. His *Sword Dance* is in the Vanderbilt collection, New York; and his famous *Christian Martyrs*, on which he worked for 20 years, is in the Walters Gallery, Baltimore. He executed fine work in sculpture, his best production in that line being *Pygmalion and Galatea*.

**GERONIMO**, an Apache Indian chief, of whose early history nothing is known. For a long time his band had been committing depredations, and finally an expedition under General George Crook was sent in pursuit. On March 25, 1886, terms were made with the chief and his band, who were sent to Fort Bowie, but they escaped on March 29. The expedition was pronounced a failure, and, on his request to be relieved, General Crook was succeeded by General Miles. Pursuit was made until the exhausted band of Geronimo was compelled to come to terms, Sept. 4, 1886; and the chief, with 14 companions, was sent to Fort Pickens, Fla. For his later history, see APACHES, *ante p. 202*.

**GERRARA OR GUERRARA**, an oasis of Algeria, in the Wadi-Mزاب, lat 32° 55' N., long. 4° 25' E.; is a trading-station with the neighboring tribes, who bring here for sale horses, ivory, gold-dust, and ostrich-feathers. Pop. 1891, 3,732.

**GERRY, ELBRIDGE**, an American statesman; born in Marblehead, Massachusetts, July 17, 1744. He entered commercial life at an early age, soon acquired a considerable fortune, and in 1773 began a public career as a member of the general court of Massachusetts Bay. In 1776 he was chosen to the Continental Congress, and signed the Declaration of Independence. He did not favor the constitution, claiming that it gave too much power to the national government. He was a member of Congress till 1780, and again from 1783 to 1785. He then accepted a seat in the Massachusetts legislature, and in 1789 was elected to the first National Congress as an Anti-federalist, and re-elected in 1791. In 1797 he was sent on a commission to France with Marshall and Pinckney, and from 1810 to 1812 was governor of Massachusetts. He was then elected Vice-President of the United States, and held the office at the time of his death, in Washington, District of Columbia, Nov. 23, 1814.

**GERRY, ELBRIDGE THOMAS**, an American lawyer; born in New York City, Dec. 25, 1837; graduated at Columbia in 1857; studied law, and attained note in his profession, being especially known as the possessor of one of the finest private law libraries in the country. In 1870 he became counsel for the Society for the Prevention of Cruelty to Animals, and in 1879 was chosen president of the Society for the Prevention of Cruelty to Children, an organization in which he took a cordial interest. He was a member of the state constitutional convention in 1867, and has been widely known as commodore of the New York Yacht Club.



GERRYMANDER, in American politics, an arbitrary apportionment of the political divisions of a state, so contrived by the dominant party as to give a larger majority to their side. The term is connected with a fancied resemblance of the outline of the Essex district of Massachusetts, formed in 1811, to a *salamander*. It was at that time thought that an unfair apportionment had been made at the instigation of Governor Gerry. Hence the term *gerrymander*.

GERSAU, a village of Schwyz canton, northeastern Switzerland, on Lake Lucerne, 7 miles W. of Schwyz, in a beautiful region. Its whey and grape cures have a considerable reputation, and its climate is very mild, and for these reasons it has grown to be quite a health-resort. From 1390 to 1798, Gersau, including a little surrounding territory, was an independent state. Population 1895, 1,771.

GERSTER, ETELKA. See GARDINI, MADAME, in these Supplements.

GERVAO, a name given to *Stachytarpheta Jamaicensis*, a West Indian and South American plant of the family *Verbenaceæ*, or vervains, whose leaves are reputed to possess valuable medicinal properties, and are also used to adulterate tea.

GERYON or GERYONES, a three-headed monster, son of Chrysaor and Callirrhoe; said to have been king of the fabulous island, Erytheia (originally supposed to lie off the coast of Epirus, but later identified as Gades, or one of the Balearic Islands), on which he kept a herd of fine oxen, guarded by a giant and the two-headed dog, Arthrus. This herd Hercules took from Geryon, thereby performing his tenth task. By some authorities, Geryon is said to have had three bodies and three heads. It was while searching for Geryon's oxen that Hercules, arriving at the confines of Europe, the Straits of Gibraltar, erected there two pillars (Calpe and Abyla), hence called the Pillars of Hercules.

GESNERIACEÆ, a family of plants closely related to the *Scrophulariaceæ*, including numerous species, mostly herbs, chiefly of tropical America. They are frequently noted for the beauty of their flowers, notably *Gloxina*, *Achimenes* and other common inmates of our greenhouses.

GESTATION. See REPRODUCTION, Vol. XX, p. 410.

GESTE, CHANSONS DE. See FRANCE, Vol. IX, pp. 641-643.

GET.Æ. See DACIA, Vol. VI, p. 758.

GETHSEMANE, a place at the foot of Mount Olivet, about three quarters of a mile N.W. of Jerusalem. A garden or orchard attached to this place was a favorite resort of Christ and his disciples. The exact spot is not now known, but the garden is pointed out to travelers, at a place where a few ancient olive trees stand. Historically, Gethsemane is best known as the scene of Christ's retirement the night before the crucifixion. The Latin priests have inclosed what in their minds is Gethsemane, while priests of other churches designate a place outside the Latin walls. Gethsemane is frequently mentioned in the New

Testament, as in Luke xxii, 39; John xviii, 2; and Matt. xxvi, 36.

GETTY, GEORGE WASHINGTON, an American soldier; born in Georgetown, District of Columbia, Oct. 2, 1819. He entered the army in 1840, immediately after his graduation from West Point, and was appointed first lieutenant of artillery in 1845, captain in 1853, major in 1863, colonel of the Thirty-seventh Infantry in 1866, and was transferred to the Third Artillery in 1871. He served on the northern frontier during the Canada border disturbances in 1840, in the war with Mexico in 1847-48, in Florida in 1849-50, and during the Civil War, with the army of the Potomac, in the Virginia peninsular campaign. He received the brevets of lieutenant-colonel, colonel, brigadier-general and major-general, United States army. In 1877 he commanded the troops along the Baltimore and Ohio railroad during the riot, and was retired from service in 1883.

GETTYSBURG, a borough and the capital of Adams County, central southern Pennsylvania, 36 miles S.W. of Harrisburg. It may be reached by the Philadelphia and Reading or the Western Maryland railroads. It contains two granite-yards and carriage manufactories. There are several educational institutions, among which are Pennsylvania College and Lutheran Theological Seminary, and there is, also, an orphan's homestead. The National Cemetery here was dedicated by President Lincoln, Nov. 19, 1863, and it has a central monument costing \$50,000. There are 3,580 Union soldiers buried here. In 1863 the famous battle of July 1st, 2d and 3d was fought in the vicinity. Population 1900, 3,495.

GETTYSBURG, BATTLE OF, was fought July 1-3, 1863, between the Federal forces under General George Gordon Meade and the Confederate troops under General Robert E. Lee. After the battle of Fredericksburg, and Hooker's sudden withdrawal of the Union army from its position (q.v., under FREDERICKSBURG, in these Supplements), no general engagements took place, and the two armies, separated by the Rappahannock, faced each other throughout May, 1863. Cavalry encounters had taken place at various points on either flank of the armies. Previous to this time the warfare in the Eastern states, with the exception of Antietam, had been south of the Potomac. Lee decided to assume the offensive, and advance his troops into Northern territory. Accordingly, he ordered, for the 1st of June, a general movement, aimed at Washington and the cities of Maryland and Pennsylvania. This northward movement of his whole army would leave the road to Richmond open to Hooker; but if Hooker took advantage of that opening, he, in turn, would leave Washington unprotected. Lee divided his army into three, practically four, divisions, and placed them in command of Ewell, Longstreet, A. P. Hill, and the fourth (the cavalry) under J. E. B. Stuart. The Confederate army began its march June 1st, and advanced up the Shenandoah valley without meeting opposition until it reached Culpeper Courthouse (June 9th), where Buford,

with a force of Union cavalry, met Ewell's advance guards, and at Winchester, on the 13th, when Milroy was met. Neither of these detachments attempted to offer resistance, but gave Hooker knowledge of Lee's movements. June 17th, Hooker had his army in position near Thoroughfare Gap, where his cavalry met Stuart and drove that general back into the valley. Ewell advanced toward Harrisburg, Pennsylvania, through Carlisle and York, but retired from Carlisle through Columbia. The farthest north reached was Carlisle (June 27th). In the mean time Hill and Longstreet advanced by way of Hagerstown, and Stuart's cavalry started on a long raid through Hanover and Carlisle, which took from Lee this strong arm of his fighting force. The Confederate forces were stretched from Hanover, south of York, to Chambersburg, north of Hagerstown. Hooker crossed the Potomac on the 26th, and marched north through Frederick, where he was superseded in the command by Meade. The Federal forces were in Maryland, near Emmitsburg and Manchester, with the exception of the cavalry, which was watching Stuart.

Between the two wings of the Confederates, and north of the Union army, lay Gettysburg, which was to be the scene of the battle. Gettysburg lies in the valley of the Cumberland, but at a point where the country is cut by valleys of small streams, which have, on either side, inclosing ridges from one half to a mile apart.

Through this valley run roads leading to the different towns of the adjoining counties, most of them centering in Gettysburg. To the west of the town is Seminary Hill, a ridge three miles in length, upon which stands a theological school. To the south of Gettysburg is a series of ridges and hills, intersected by ravines and gullies. The point of these hills farthest west is a little to the north of the general trend, and, with its connecting ridges, forms a curve or outward bend. Joining this curved part is a long line of hills, which end in two prominences, and finally in open country. The extreme western point of the curve is known as Culp's Hill, the two prominences as Little and Big Round Top, and the long connecting ridge as Cemetery Hill. Between Little Round Top and Cemetery Hill, filling a gap in the long line, is a ridge, which stands out in the valley, and is known as Peach Orchard. Near Big Round Top is Devil's Den, a small knoll, and Rock Creek. These hills and ridges are wooded, and in some portions very steep and rocky.

Lee advanced Hill's corps from the northwest, Longstreet's from Chambersburg on the west, and Ewell's from Carlisle on the northeast. Lee concentrated his forces on Seminary Hill, extending his line so as to cover the town of Gettysburg and Culp's Hill, confronting Cemetery Ridge. Meade moved his forces from the southeast, south and southwest. Reynolds was in the advance, with the First Corps, closely followed by Howard, with the Second. Buford's cavalry, in its skirmishing, encountered Longstreet's advancing di-

vision from Chambersburg, and held the Confederates until Reynolds came up. Reynolds posted his men along Seminary Hill and on Oak Hill, the north end of the Seminary Ridge. The Confederates attacked the line, but were repulsed with losses. Reynolds, however, lost his life in the first of the fighting. Howard came up and took command, extended the line to include Cemetery Hill, and sent a part of his command to check Ewell's advance on the north of Gettysburg. This latter detachment was driven back through the town to the fortifications of Howard, on Cemetery Hill. Howard took possession of Culp's Hill and fortified it. This ended the work of the first day, but it served to indicate that the battle, which Meade had desired to fight in the Pipe Creek valley, farther south, was to be fought at Gettysburg. Both generals hastened to concentrate their troops. Longstreet's division came up in the night. The various corps of the Union army hastened to the front, and were assigned positions along Cemetery Hill, Peach Orchard and the Round Tops. The last corps to arrive was Sedgwick's (the Sixth), and was sent to Big Round Top. Sickles placed his brigade on Peach Orchard and Devil's Den, on an exposed front, which was sure to attract to it an immediate attack. The second day's fighting did not begin until four o'clock in the afternoon. Longstreet's forces were sent against the two Round Tops and Sickles's fortifications on Peach Orchard, and Sickles was driven back to a point even with the line on Cemetery Hill. The Union forces held Little Round Top only after severe fighting. At the same time Ewell had assaulted Culp's Hill, which had been fortified by Ruger and Geary. His attack was unsuccessful. On this second day the artillery had played an important part. The third day's battle was opened with a sharp artillery fire from over 220 guns, 140 belonging to the Union army and about 80 to the Confederates. Charges were made along the whole line, and the fighting was general throughout the day. Ruger and Geary recovered the ground lost the day before. The culminating movement of the day, and of the three days' battle, was Pickett's charge on the Union left and center. This charge was across the valley, in the face of a cross artillery and infantry fire, and was met with such murderous volleys as to break the charging line and decide the battle for the Union, Lee, with his rear carefully guarded, retreating that night through Maryland, across the Potomac. This battle, in the opinion of many critics, was the military high-water mark of the Confederacy, and from its close until Appomattox the wave of Confederate success steadily receded. As to the numbers engaged, no exact information is obtainable. Lee had about 88,000 men, and Meade about 87,000. The Union killed, wounded and missing were about 23,000; the Confederate, about 26,000.

GEUM, a genus of *Rosacea*. Two species are common natives of Britain, *G. urbanum*, the wood-avens, or herb-bennet, and *G. rivale*, water-avens. The so-called *G. intermedium* is usually regarded

as a mere hybrid of these two species. Both are aromatic, tonic, and astringent, and of old repute among herbalists; the rootstock of *G. urbanum* was formerly gathered in early spring to impart its clove-like flavor to ale, and is still used in the preparations of liqueurs. There are several species in North America, *G. vernum* being one of the earliest spring flowers.

**GHALCHA LANGUAGE**, language of Kafir tribes. See **KAFIRISTAN**, Vol. XIII, p. 822.

**GHARA**, the name of the Sutlej river in the Punjab, India, from its confluence with the Beas to its junction with the Chenab; 300 miles long; from 200 to 500 yards wide; nowhere fordable.

**GHARDAIA**, the chief town of the Mزاب Confederation in the Algerian Sahara, built on the slope of a hill on the right bank of the Wadi Mزاب, in 32° 29' N. lat.; 3° 54' E. long. Pop. 1896, 30,324.

**GHAWAZIS**. See **EGYPT**, Vol. VII, p. 727.

**GHENT**, TREATY OF, Dec. 24, 1814, between the United States and Great Britain, ending the war of 1812. See **UNITED STATES**, Vol. XXIII, p. 759.

**GHERARDI**, **BANCROFT**, an American naval officer, was born in Jackson, Louisiana, Nov. 10,

1832; entered the navy from Massachusetts, as midshipman, in 1846, and served on the *Ohio*, of the Pacific squadron, till 1850, entering the Naval Academy in 1852. He became master and lieutenant in 1855, and at the beginning of the Civil War was on the *Lancaster*, of the Pacific squadron. He was made lieutenant-commander in 1862, and took part in the engagement with Fort Macon in that year. In 1863-64 he successively commanded the gunboat *Chocorna* and the steamer *Port Royal*, of the West Gulf blockading squadron. In the latter vessel he took part in the battle of Mobile Bay, and distinguished himself for coolness and courage. He was promoted to commander in 1866, to captain in 1874, to commodore in 1884, and in 1885 served on the board of examiners for promotion. In 1886 he was made commandant of the Brooklyn navy-yard, and in 1887 he became rear-admiral. Rear-admiral Gherardi was appointed to supervise the grand review of the naval forces of the world at Hampton Roads, in April, 1893. He was placed on the retired list, Nov. 10, 1894.



REAR-ADMIRAL GHERARDI.

tenant-commander in 1862, and took part in the engagement with Fort Macon in that year. In 1863-64 he successively commanded the gunboat *Chocorna* and the steamer *Port Royal*, of the West Gulf blockading squadron. In the latter vessel he took part in the battle of Mobile Bay, and distinguished himself for coolness and courage. He was promoted to commander in 1866, to captain in 1874, to commodore in 1884, and in 1885 served on the board of examiners for promotion. In 1886 he was made commandant of the Brooklyn navy-yard, and in 1887 he became rear-admiral. Rear-admiral Gherardi was appointed to supervise the grand review of the naval forces of the world at Hampton Roads, in April, 1893. He was placed on the retired list, Nov. 10, 1894.

**GHIKA**, **HELENA**, PRINCESS. See **KOLTZOFF-MASSALSKV**, in these Supplements.

**GHIKA FAMILY**, an Albanian house founded in the seventeenth century by George Ghika, who was made hospodar of Wallachia in 1657. From that time on his family has furnished many of the patriot rulers of Wallachia and Roumelia. In the nineteenth century three members have been especially prominent: Alexander (1795-1862), Gregory (1807-57), and John, who died in 1881.

**GHIZEH** OR **GIZEH**. See **ARCHITECTURE**, Vol. II, pp. 385-387

**GHOST**. See **APPARITIONS**, Vol. II, pp. 202 et seq.

**GHOST-DANCE**. The Indians of North America are naturally superstitious. Their primitive religions, augmented by the Christian teachings, which they but half understood, developed in the minds of some of the tribes the belief that when the Messiah came he would bring with him all the warriors who had died. This doctrine originated, no doubt, in the early part of the nineteenth century, and in their war-dances and other ceremonies the Indians dedicated a certain portion of the orgies to the spirits of the departed who were to return. This doctrine seemed not to have had any firmer hold upon the Indian mind than any other superstition until, in June, 1889, it seemed suddenly to become a ruling thought. This was taken advantage of by certain artful "medicine-men" to stir up the Indians of the Northwest against the whites. It was given out that the advent of the Messiah was at hand, and that with him were coming the dead warriors and herds of buffaloes. It was also foretold that the whites were to be swallowed up by the earth and the Indians left in possession of all the land. This was first announced by a Shoshone "medicine-man" in the Big Horn Valley, in Montana, whose predictions were followed by those of other prophets among the Sioux, Piutes, etc. It was commanded that all the tribes should assemble and dance continuously for five days, at the expiration of which the Messiah would appear. These dances began, and were known first as "dances of death," but later as "ghost-dances." Chiefs took advantage of the excitement to arouse the warriors to arms, and soon it was feared that the fanaticism would result in an Indian outbreak. The United States troops were called out, and checked the uprising after several bloody encounters, which resulted in the suppression of the Indians, the deaths of several chiefs, including Sitting Bull, the leader of the Sioux, and of a number of United States officers and men. The "ghost-dance" is a circular dance which usually attains its height in the night, when the fires are lit and the warriors encircled by the women and children. During the whole dance ghost-songs, together with prayers, are uttered. The dancers become dizzy and exhausted from the circular motion until they fall in a trance, during which they claim to see the spirits or ghosts of their dead friends. The ghost-dance is continued by all the nomadic tribes at certain stated intervals.

**GHOST-MOTH** (*Heptalus humuli*), a large European moth. The wings are white underneath and brown above. The insect has a peculiar hovering flight, alternately exposing the upper and lower surfaces, so that when seen at a distance it seems to periodically vanish. This peculiarity gave the name. The larvæ bore in the stalks and roots of many plants.

**GIANNI**, **LAPO**, an Italian lyric poet, about whose life we have little information. He was a companion of Dante. See **ITALY**, Vol. XIII, p. 502.

GIANNOTI, BONATO, an Italian historian; born in Florence, Nov. 27, 1492; died in Rome in 1573. He was a contemporary of Machiavelli, but far less able and influential, both as a statesman and writer. He took a prominent part in republican movements, and was banished from Florence. He was a favorite companion of Cardinals Ridolfi and Tournon, and served Pius V in Rome. He wrote *Della Repubblica de' Viniziani* (1530); *Della Repubblica Fiorentina* (1531); a comedy, *Il Vecchio Amatoro* (1536); and other works.

GIBBES, ROBERT WILSON, an American physician and historian; born in Charleston, South Carolina, July 8, 1809. He was graduated at South Carolina College in 1827, and from 1827 to 1835 was assistant professor of geology and chemistry in that institution. He engaged in journalism in Columbia, South Carolina, as editor of the *Daily South Carolinian*. He served the Confederacy during the Civil War as surgeon-general of South Carolina. He had made a collection of minerals and works of art, but this was destroyed at the time of the burning of Columbia in 1865. He published a number of scientific articles; among them, *Monograph on Fossil Squalids*. His historical work centered in his *Documentary History of the American Revolution, Relating Chiefly to South Carolina* (1853). He died in Columbia, South Carolina, Oct. 15, 1866.

GIBBITES, the followers of John Gib, a Scottish fanatic who came into notice about 1681. The Gibbites, or, as they were otherwise known, "Sweet Singers," renounced all existing creeds and customs, and pretended to return to the original purity of paradise. Their ideas concerning primitive manners, manifested by discarding clothes, and their intemperate notions of feasting, soon led to such debauchery as to oblige the authorities to put a stop to their practices.

GIBBON, a tailless ape. See APE, Vol. II, pp. 150, 151.

GIBBON, JOHN, an American soldier; born near Holmesburg, Pennsylvania, April 20, 1827. He entered the army in 1847, immediately after graduation from West Point, and served till the close of the Mexican War. In 1854-57 he was assistant instructor of artillery at West Point, and was quartermaster there in 1856-59. In 1859 he became captain in the Fourth Artillery, chief of artillery in General McDowell's division in 1861; in 1862 was made brigadier-general of volunteers, and in 1864 major-general. He took part in the battles of Fredericksburg and Gettysburg, and in the fighting before Petersburg. In 1866-69 he was colonel of the Thirty-sixth Infantry; and in 1869-86 of the Seventh Infantry. He commanded the column that rescued Reno from the Sioux under Sitting Bull, in 1876. In 1877, with 191 men, he defeated over 500 Nez Percés warriors, under Chief Joseph, in the Big Hole Valley, Mont., killing over 200 of the Indians. In 1886 he was promoted brigadier-general; and retired April 20, 1891. He wrote *The Artillerist's Manual* (1859). Died in Baltimore, Feb. 6, 1896.

GIBBONS, ABIGAIL (HOPPER), an American

philanthropist; born in Philadelphia, Pennsylvania, Dec. 7, 1801; died in New York City, Jan. 10, 1893. She was a daughter of Isaac T. Hopper, an abolitionist; married James Sloan Gibbons in 1833, and early became interested in the reform movements of the time, giving particular attention to the condition of women and children. She was instrumental in the act of the legislature of New York establishing the State Reformatory for Women and Girls, and was one of the directors of the Diet Kitchen Association, of the Isaac T. Hopper Home and of the Women's Prison Association.

GIBBONS, JAMES, an American Roman Catholic churchman; born in Baltimore, Maryland, July 23, 1834. In 1861 he was ordained priest, and became assistant priest at St. Patrick's Church, Baltimore, Maryland. A few months later he became pastor of St. Bridget's Church, and then was transferred to the cathedral, and appointed chancellor of the archdiocese. In 1868 he was made vicar apostolic of North Carolina, with the rank and title of bishop, and in 1872 was assigned to the see of Richmond, Virginia, then vacant. In 1877 he was appointed coadjutor to Archbishop Bailey of Baltimore, and in the same year succeeded him. In 1886 Archbishop Gibbons became a cardinal, being the second American to receive this honor. He published *The Faith of Our Fathers* (1876) and *Our Christian Heritage* (1889).



CARDINAL GIBBONS.

GIBBONS, JAMES SLOAN, banker, writer, and philanthropist; born in Wilmington, Del., July 1, 1810. He was for some time a merchant in Philadelphia, and from 1835 until his death a banker in New York city. He wrote the famous war-song, *We Are Coming, Father Abraham*, and two works of value, *The Banks of New York and the Panic of 1857* (1858) and *The Public Debt of the United States* (1867). He is remembered on account of his benefactions. Died in New York, Oct. 17, 1892. His wife was ABIGAIL (HOPPER) GIBBONS (q. v.), with whose efforts for women he was in sympathy, and whom he aided financially.

GIBBONS, WILLIAM, an American physician and writer; born in Philadelphia, Pennsylvania, Aug. 10, 1781; father of James Sloan Gibbons. He graduated at the University of Pennsylvania in 1805, and practiced in Wilmington, Delaware, until his death. He was a "Friend," and devoted much of his time to the interests of the society. He published *Exposition of Modern Scepticism*, a pamphlet, and several articles, under the name "Vindex." He died in Wilmington, Delaware, July 25, 1845.

GIBBS, ALFRED, an American soldier; born in Sunswick, Long Island, April 22, 1823; a brother of Oliver Wolcott Gibbs. He graduated

at West Point in 1846, and took part in the Mexican War. In 1848-60 he was on frontier duty in California and New Mexico. He served under General Sheridan, in the cavalry, throughout the Civil War. At the close of the war he had attained the rank of brevet major-general. From 1866 to 1868 he was major of the Seventh United States Cavalry. He died in Fort Leavenworth, Kansas, Dec. 26, 1868.

GIBBS, JOSIAH WILLARD, an American philologist; born in Salem, Massachusetts, April 30, 1790. He graduated at Yale in 1809. From 1811 to 1815 he was a tutor in Yale College, and for some years at Andover, where he devoted himself to the study of Hebrew and Biblical literature. From 1824 until his death, he was professor of sacred literature in the Theological School of Yale College. He published *Philological Studies, with English Illustrations* (1856); *Teutonic Etymology* (1860); and translations of Gesenius's *Hebrew Lexicon of the Old Testament* (1824); and *Manual Hebrew and English Lexicon* (1828). He died in New Haven, Connecticut, March 25, 1861.

GIBBS, OLIVER WOLCOTT, an American chemist; born in New York City, Feb. 21, 1822. He graduated in 1845 at the College of Physicians and Surgeons in New York, and then studied chemistry for three years in Germany. From 1849 to 1863 he was professor of physics and chemistry in the College of the City of New York, and in 1863 became professor of chemistry and physics in Harvard University. In connection with his work he made valuable discoveries in organic chemistry, and was active in general scientific work. He constantly contributed to scientific periodicals, and was one of the editors of *The American Journal of Science*.

GIBEL OR PRUSSIAN CARP (*Cyprinus gibelio*), a small fresh-water fish, common in Europe. It is an excellent food-fish.

GIBSON, CHARLES DANA, an American illustrator and artist. He made his *début* in *Life*, in a very modest way, March 25, 1886, when he had therein a little sketch, *The Moon and I*, representing a small dog confined by a chain and baying the moon. He became famous with his creation of the American girl. His series of sketches in which he depicted this charming character received wide notice. The

*London Chronicle*, in 1892, noticed his delicate work, comparing it with that of Du Maurier, and saying that Gibson "followed effects of nature, while Du Maurier ignored them." In March, 1892, an exhibition of Gibson's *Life* sketches was made at Sanchez and Miller's Gallery in New York City. In October, 1893, he made a visit to Europe, on the eve of which his New York friends banqueted him at the Player's Club. In 1894 a *Collection of Eighty-*

*four Drawings by C. D. Gibson* was published, and again in 1895 a collection of his drawings was made at Keppel's Gallery, New York City, among them being *Canoeing*; *Reading the Will*; and *Going in to Dinner with the Duke of Sloppy Weather*. In 1896 another collection of his drawings appeared in book-form. The secret of the original, if any, of his favorite model of the American girl has been well kept. Many guesses have been made, but all apparently incorrect.

GIBSON, JOHN MUNRO, a British Presbyterian clergyman; born in Whithorn, Scotland, April 24, 1838. He studied in Glasgow, Scotland, and afterward at Knox College and the University of Toronto, Canada. He began his pastoral work in Montreal, Canada, in 1864, and in 1874 was transferred to the Chicago Second Presbyterian Church, and in 1880 to St. John's Wood Presbyterian Church, in London, England. He was prominent in the church organization; and in 1891 was moderator of the English synod. He published *The Ages before Moses* (1879); *The Foundations* (1880); *The Mosaic Era* (1881); and *Christianity According to Christ* (1890).

GIBSON, RANDALL LEE, an American soldier and public man; born in Spring Hill, Kentucky, Sept. 10, 1832. He was graduated at Yale in 1853, and spent the next two years in Germany. He engaged in sugar-planting in Louisiana, and at the beginning of the Civil War enlisted as a private in the Confederate army, served as colonel of the Thirteenth Louisiana Infantry, and was promoted major-general. Chosen to Congress in 1872, he was not allowed to take his seat. Elected again in 1874, he served until 1882, when he was chosen Democratic United States Senator from Louisiana, and was re-elected in 1888. He died before the expiration of his second term, in Hot Springs, Arkansas, Dec. 15, 1892.

GIBSON, WILLIAM, an American surgeon; born in Baltimore, Maryland, in 1788. After graduating at Princeton in 1806, he studied in Scotland, at the University of Edinburgh. He practiced his profession in Baltimore until seventy years of age, when he retired to Newport, Rhode Island. He was professor of surgery in the University of Pennsylvania from 1819 to 1849. He published *Principles and Practice of Surgery* (1824); *Rambles in Europe* (1839); and *Eminent Belgian Surgeons and Physicians* (1841). He died in Savannah, Georgia, March 2, 1868.

GIBSON, WILLIAM HAMILTON, an American illustrator and author; born in Sandy Hook, Connecticut, Oct. 5, 1850. He was a student at the Brooklyn Polytechnic Institute, and in 1870 became connected with *The American Agriculturist* and *Hearth and Home*, as an illustrator of articles upon subjects in botany. He afterward contributed illustrations to various journals, but did not become generally known until his work began to appear in *Harper's Magazine*, where his exquisite designs and technique placed him among the foremost of American artists. His first illustrations in *Harper's* appeared in connection with Mrs. Conant's *Birds and Plumage*. He illustrated



CHARLES DANA GIBSON.

E. P. Roe's *Nature's Serial Story*, and wrote, with illustrations by his own hand, *Camp-Life in the Woods* (1876); *Pastoral Days* (1881); *Highways and Byways* (1883); *Happy Hunting Grounds* (1886); *Strolls by Starlight and Sunshine* (1891); *Sharp Eyes* (1892); and *Edible Toadstools and Mushrooms* (1896). He was, in his later years, a popular lecturer on botanical themes, and a sympathetic delineator of plant-life. He died in Washington, Connecticut, July 16, 1896.

GIBSON, WILLIAM HARVEY, an American soldier; born in Jefferson County, Ohio, in 1822. He was admitted to the bar of Ohio in 1841, and took an active part in state and national politics. At the beginning of the Civil War he held the office of state treasurer, which he resigned to enter the Union army as colonel. He took part in the Western campaigns and attained the rank of brevet brigadier-general. He returned to the practice of law and participated in political campaigns as a Republican. He died in Tiffin, Ohio, Nov. 22, 1894.

GIBSON CITY, a town in Ford County, northwestern Illinois, on the Illinois Central, the Lake Erie and Western and the Wabash railroads, 32 miles E. of Bloomington. It is in an agricultural district; has a fence factory, iron-works, canning factory, brick and tile factory, cigar factory and oil-works. Population 1890, 1,803; 1900, 2,954.

GIDDINGS, a village and the capital of Lee County, southeastern central Texas, 50 miles E. of Austin, on the Houston and Texas Central and the San Antonio and Aransas Pass railroads. Coal, iron and gypsum are found in the neighborhood, and cattle are raised. There are manufactures of dentists' supplies, bricks and soda-water. Population 1890, 1,203.

GIDDINGS, JOSHUA REED, an American statesman; born in Athens, Pennsylvania, Oct. 6, 1795. He was admitted to the Ohio bar in 1820, and in 1826 was elected to the legislature, serving one term. In 1838 he was chosen, as a Whig, to Congress, and for twenty years was a member of that body. He was an active abolitionist, and as early as 1841 maintained in Congress that slavery was a crime. He opposed the annexation of Texas and the compromise measures of 1850. From 1861 to his death he was United States consul-general in Canada. Mr. Giddings published a volume of his speeches (1853), and wrote *The Rebellion: Its Authors and Causes*, issued posthumously (1864). He died in Montreal, Canada, May 27, 1864.



JOSHUA R. GIDDINGS.

GIERS, NICHOLAS CARLOVITCH DE. See DE GIERS, NICHOLAS CARLOVITCH, in these Supplements.

GIFFORD, ROBERT SWAIN, an American ar-

tist; born on the island of Naushon, Buzzard's Bay, Massachusetts, Dec. 23, 1840. He spent several years in Holland, studying under Albert van Beest. He settled first in Boston, and later permanently in New York City. He is a landscape-painter of considerable merit, and attracted early attention both by his oil-paintings and pictures in water-color. Among the latter are *Deserted Whaler* (1867); *An Autumn Day on the Sea-Shore* (1869); and *Evening in Sahara* (1877). Among his oil-paintings are *Mount Hood, Oregon* (1870); *Passenger-Boats on the Nile* (1874); *Cedars of New England*; and *The Border of the Desert* (1877).

GIFFORD, SANDFORD ROBINSON, an American landscape-painter; born in Greenfield, New York, July 10, 1823. He devoted himself to portrait-painting from 1842 to 1846, when he turned to landscapes. Among his paintings are *Morning in the Adirondacks* (1867); *Sunset on the Sweetwater, Wyoming* (1874); and *Sunset, Bay of New York* (1878). His *Ruins of the Parthenon* is in the Corcoran Gallery at Washington, District of Columbia. He died in New York City, Aug. 29, 1880.

GIGNOUX, FRANÇOIS REGIS, a French landscape-painter; born in Lyons, France, in 1816; died in Paris, Aug. 6, 1882. He studied under Delaroche at the Paris School of Fine Arts. From 1844 to 1870 he was in Brooklyn, New York, and in 1851 became a member of the Academy of Design, and was the first president of the Brooklyn Art Academy. He returned to France in 1870, and there resided until his death. His paintings include *Virginia in Indian Summer*; *Niagara by Moonlight*; *The Dismal Swamp*; and *Mount Washington*. He was especially effective in winter scenes, and his *Niagara in Winter* displays his work to good advantage.

GIGOUX, JEAN FRANÇOIS, a French painter; born at Besançon, Jan. 8, 1809. After studying at the École des Beaux-Arts, Paris, he exhibited his first picture in 1831. His subjects are chiefly historical, as *The Death of Cleopatra* and the *Taking of Ghent*, and religious, as *The Baptism of Christ*, and the *Last Ecstasy of St. Mary Magdalene*. He also painted portraits, among them those of Lamartine, Houssaye and Taillandier; and was successful in his decoration of churches, especially in that of St. Gervais, Paris. He died Dec. 10, 1894, in Besançon.

GILA MONSTER (*Heloderma suspectum*), a large poisonous lizard of Arizona, New Mexico and Texas. It is dusky brown, mottled with orange and occasional pinkish spots. It attains a length of about three feet. It is greatly feared, but overestimated. Experiments show that it secretes a powerful poison, causing death very quickly to small animals, but its bite is not necessarily fatal to man.

GILA RIVER rises in the southwestern part of New Mexico, in the Sierra Madre, flows generally westward, and joins the Colorado River in Yuma County, Arizona, at the southeastern extremity of California. Its total length is variously estimated at from five hundred to six hundred

miles. Gold and silver are found near this river in Arizona, and the ruins of an ancient civilization abound in its lower valley. Its chief tributaries are the Rio Verde, Rio Santa Cruz and the Rio San Pedro.

GILBERT, CHARLES CHAMPION, an American soldier; born in Zanesville, Ohio, March 1, 1822. He graduated at West Point in 1846, and served in the Mexican War. He was assigned to frontier duty until the beginning of the Civil War, when he was stationed in Kentucky and Tennessee. He was inspector-general of the army of the Ohio and of the Cumberland, and later in command of the army of Kentucky. He had attained the rank of brigadier-general at the close of the war. He remained in the army as colonel, and was retired in 1886.

GILBERT, CHARLES HENRY, an American zoölogist; born in Rockford, Illinois, Dec. 5, 1859. He studied at Butler University and the University of Indiana. He was appointed professor of zoölogy in the University of Cincinnati in 1844, and held a similar position in Indiana University and in Leland Stanford University, California. He made a special study of fishes, and is the author of a number of papers relating to this branch of science; the best-known article being one written in conjunction with David Starr Jordan, entitled *Synopsis of the Fishes of North America* (1882).

GILBERT, GROVE KARL, an American geologist; born in Rochester, New York, May 6, 1843; graduated at the university there in 1862. After serving on several important surveying expeditions, he became, in July, 1879, geologist to the United States survey and, in 1889-92 was chief geologist of the United States. He was president of the American Society of Naturalists and vice-president or member of several scientific societies, and wrote papers on the geology of the Rocky Mountains and the Black Hills, and two papers, *Lake Bonneville* (1890) and *Geology of the Henry Mountains* (1877).

GILBERT, SIR JOHN, an English painter; born at Blackheath, near London, England, in 1817. He exhibited pictures, both in oil and water-color, at the leading English galleries since 1836, and became a Royal Academician and president of the Royal Society of Painters in Water-Colors. As an illustrator of books, pictorial newspapers, etc., his name was familiar, and he contributed to the *Illustrated London-News* for many years. Most of the best editions of the British classics have been illustrated by him, including an edition of Shakespeare. His favorite subjects were historical ones. Among his paintings are *Don Quixote and Sancho Panza*; *Murder of Becket*; and *Morning of Agincourt*. Died at Villers-sur-mer Oct. 6, 1897.

GILBERT, JOHN GIBBS, an American actor; born in Boston, Massachusetts, Feb. 27, 1810. On Nov. 28, 1828, he began a series of tragic performances at the old Tremont Theater, in his native city, where he appeared in the rôles of Jaffier, Sir Edward Mortimer, and Shylock. After having played in Western and

Southwestern theaters for four years, he returned to Boston. In 1847 he joined the company of the Princess Theater, in London, where he played in standard English comedy, appearing at first as Sir Robert Bramble in the *Poor Gentleman*. In 1848 he returned to the United States, and performed at the Park Theater and at the Bowery Theater. In 1851 he went to Philadelphia for five years; in 1856 and 1857 was in Boston; from 1858 until 1862 performed in Philadelphia, and afterward made his home in New York City. He was most popular in Sir Peter Teazle, Job Thornberry and Old Dornton. He died in Boston, Massachusetts, June 17, 1889.

GILBERT, SIR JOHN THOMAS, Irish historian; born in Dublin in 1829. He was secretary of the public record office of Ireland from 1867 to 1875; a member of the Royal Irish Academy, its professor of archæology and its librarian. He published *A History of the City of Dublin* (1859); *Celtic Records and Historic Literature of Ireland* (1861); *Historic Documents of Ireland* (1870); *History of Affairs in Ireland from 1641 to 1652* (1881); and *History of the Irish Confederation and the War in Ireland* (1888). Died in London, May 23, 1898.

GILBERT, JOSEPH HENRY, a British chemist; born at Hull, England, Aug. 1, 1817; studied at Glasgow University, at University College, London, and at Giessen, Germany—at the last-mentioned place under the celebrated Liebig. After taking his doctorate at Giessen he was appointed instructor in University College, London, in 1840. He conducted a course of experiments and researches in agricultural chemistry and the physiology of farm animals, the results of which have been published in a series of valuable papers. He became professor of rural economy in Oxford in 1884.

GILBERT, WILLIAM SCHWENCK, an English dramatist; born in London, Nov. 18, 1836. He was educated at Great Ealing School, and received the degree of B.A. from the London University in 1857. From that time to 1862 he was clerk in the Privy Council office, and in 1864 he was admitted to the bar. For many years afterward he was on the editorial staff of *Fun*, in the columns of which his *Bab Ballads* first appeared. His stage-work began with a Christmas burlesque, *Dulcamara* (1866), which was followed by a succession of dramas, burlesques, comedies and operas. Among his fairy comedies are *The Palace of Truth* (1870); *Pygmalion and Galatea* (1871); *The Wicked World* (1873); and *Broken Hearts* (1876). Among his comedies are *Sweethearts* (1874) and *Engaged* (1877). His other plays include *Charity*; *Gretchen*; *Comedy and Tragedy*; etc. In 1876 appeared his comic opera, *Trial by Jury*, in which he was as-



WILLIAM S. GILBERT.

sociated with Sir Arthur Sullivan. In conjunction with the latter he also produced *The Sorcerer*; *H. M. S. Pinafore*; *The Pirates of Penzance*; *Patience*; *Iolanthe*; *Princess Ida*; *The Mikado*; *Rudigore*; *The Yeomen of the Guard*; *The Gondoliers*; and *The Grand Duke* (1896).

**GILBERTINES**, an order of monks. See **GILBERT**, SAINT, Vol. X, p. 593.

**GILBERT ISLANDS**, a group of 16 inhabited islands, of coral formation, in Micronesia, near lat. 3° 20' N. and long. 175° E., claimed by Great Britain. Area, 166 square miles; population 1891, 35,200. Its products are cocoanuts, taro and pandanus. See also **MICRONESIA**, Vol. XVI, pp. 256, 257.

**GILCHRIST, ALEXANDER**, a British writer, biographer of William Blake; born in Newington Green, England, in 1828. He was educated at University College, London, and was called to the bar in 1849, but never practiced. He devoted himself to literary criticism, and after collecting, in Yorkshire, materials for a life of Etty, the painter, he settled in Guildford in 1853. The *Life of Etty* appeared in 1855. The following year he moved to Chelsea and began work upon his *Life of Blake*. Before it was completed he died, Nov. 30, 1861. Mrs. Blake, with the aid of W. M. Rossetti, finished the biography in 1863, and in 1880 issued a second edition, with a memoir of her husband.

**GILDER**, an American family of prominence, especially in the field of literature. The father, **WILLIAM HENRY**, a clergyman, was born in Philadelphia, Pennsylvania, Sept. 17, 1812; died at Brandy Station, Virginia, April 13, 1864. He entered the ministry of the Methodist Church in 1833. He published the Philadelphia *Literary Register* in 1840, and in 1842 founded the Bordentown (New Jersey) Bellevue Seminary, afterward the Flushing (Long Island) Bellevue College. During the Civil War he served as chaplain until his death, from smallpox.—His eldest son, **WILLIAM HENRY**, an Arctic explorer, was born in Philadelphia, Pennsylvania, Aug. 16, 1838. He served throughout the Civil War, attaining the brevet of major. He was with Lieutenant Schwatka on the King William's Land polar expedition of 1878, and was with the *Rodgers* in 1881, and crossed from Bering Sea, through Siberia, to the

Russian telegraph line, to communicate with the United States government. He afterward traveled in Tonquin and Europe, acting as correspondent of the New York *Herald*. He was the author of *Schwatka's Search* (1881) and *Ice-Pack and Tundra* (1883).—**RICHARD WATSON**, an American poet and critic, second son of William Henry, Sr.,



RICHARD WATSON GILDER.

was born in Bordentown, New Jersey, Feb. 8, 1844. In 1865 he became an editor of the Newark (New

Jersey) *Advertiser*, and three years later, with Newton Crane, established the Newark *Morning Register*. Mr. Gilder, in 1870, accepted the associate editorship of *Scribner's Monthly* (now *The Century Magazine*), of which, on the death of Dr. Holland in 1881, Mr. Gilder was made editor-in-chief. In addition to his editorial and literary labors, Mr. Gilder took an active interest in all public matters. He was one of the founders of the Society of American Artists, the American Copyright League, the Author's Club and the Free Art League. He published six volumes of poems: *The New Day* (1875); *The Poet and His Master* (1878); *Lyrics* (1885); *The Celestial Passion* (1887); *Two Worlds, and Other Poems* (1891); and *The Great Remembrance* (1893).

—**JEANNETTE LEONARD**, daughter of William Henry, Sr., was born Oct. 3, 1849, in Flushing, Long Island. In 1881 she established the *Critic*, in New York City, and edited and managed that journal, in conjunction with her brother, **JOSEPH B.** (born June 29, 1858, in Flushing, Long Island). Miss Gilder was literary correspondent for several Western papers, among them the *Chicago Tribune*, and was co-editor of *Authors at Home* (1888), with her brother, Joseph B., and with Helen Gray Cone in *Pen Portraits of Literary Women* (1887). She was also the editor of *Representative Poems of Living Poets, American and English* (1886).

**GILDERSLEEVE, BASIL LANNEAU**, an American educator; born in Charleston, South Carolina, Oct. 23, 1831. He graduated at Princeton College in 1849, and studied in Germany, at Berlin, Bonn and Göttingen for four years. In 1856 he was chosen professor of Greek in the University of Virginia, where he remained till 1876. Upon the establishment of Johns Hopkins University, he was appointed professor of Greek there. Professor Gildersleeve for a time edited the *Baltimore American Journal of Philology*, and published six Latin text-books, and also editions of *Persius* (1875); *Justin Martyr* (1877); and the *Olympian and Pythian Odes of Pindar* (1885).



BASIL L. GILDERSLEEVE.

**GILES, CHAUNCEY**, an American Swedenborgian clergyman; born at Charlemon, Massachusetts, May 11, 1813; entered Williams College, but, on account of ill health, was compelled to leave before completing his course. He became a teacher, and in 1853 was ordained a clergyman of the New Jerusalem Society, and preached in Cincinnati for 10 years, in New York City for 15 years, and then became pastor in the first New Jerusalem Society in Philadelphia. In 1858 he was elected president of the Urbana University, and in 1863 became ordaining minister of the church, which office is functionally equivalent to that of bishop in other churches. In 1875 he was



erected president of the General Convention of the church of the New Jerusalem Society, which office he held until his death, which occurred at West Philadelphia, Nov. 6, 1893. He was editor, for several years, of the *New-Church Messenger* and of the *Children's New-Church Magazine*. He published more than two hundred sermons in tract-form. His *Man as a Spiritual Being* (1868) was translated into several languages.

GILES, HENRY, an American Unitarian minister; born at Craanford, Wexford County, Ireland, Nov. 1, 1809. He was educated at Belfast as a Roman Catholic, but abandoned that faith and became a Unitarian. He preached in Greenock, Scotland, 1835-37, and then three years in Liverpool, England. In 1840 he went to the United States, and soon became eminent as a lecturer. He contributed to many periodicals, and published *Lectures and Essays* (1850); *Christian Thought on Life* (1851); *Illustrations of Genius* (1854); *Human Life in Shakspeare* (1868); etc. He died in Boston, July 10, 1882.

GILFERT, AGNES, an American actress, was best known to the stage as Agnes Holman; born in England in 1793; died in Philadelphia, Pennsylvania, April 19, 1833. She made her *début* at the Haymarket Theatre, in London, as Belvidera, in Otway's *Venice Preserved*, and in 1812 went to New York City. In 1815 she married Charles Gilfert.

GILFILLAN, JAMES, an American jurist; born in Scotland, March 9, 1829; went to the United States with his parents in 1830. He practiced law in New York state, and in 1857 removed to Minnesota. He served in the campaign against the Sioux Indians in 1862-63, and afterward in the Civil War. In July, 1869, he became chief justice of the state supreme court for one year; was appointed to the same office in 1875 and held the position by election until his death. He annotated the first twenty volumes of the *Minnesota State Reports*. He died in St. Paul, Minnesota, Dec. 16, 1894.

GILL, DAVID, a Scotch astronomer; born in Aberdeenshire, June 12, 1843; was educated at Marischal College of Aberdeen University. He became associated with Lord Lindsay (now Earl of Balcarres), who had erected a magnificent observatory at Dunecht House, in Aberdeenshire, and under his patronage he observed the transit of Venus at Mauritius in 1874. In 1877 he was chief of an expedition to the island of Ascension to determine the solar parallax from observations on Mars. In 1881 he was appointed astronomer royal at the Cape of Good Hope. Through his labors the observatory there has become famous throughout the astronomical world. He published numerous reports on the solar and stellar parallaxes, the transit of Venus and other astronomical phenomena. He was made LL.D. of Aberdeen and Edinburgh, and a fellow of the Royal Society.

GILL, THEODORE NICHOLAS, an American naturalist; born in New York City, March 21, 1837. In 1863 he became an assistant in the Smithsonian

Institution, and in 1879 was assigned the task of preparing the reports of the institution. He was, for some years, senior assistant librarian of Congress. From 1884 to 1887 he was professor of zoölogy in the Columbian University, Washington, District of Columbia. He published a great number of scientific papers, of which some of the more important are *Prodrome of a Monograph of Pinnipeds* (1866); *Primary Subdivisions of the Cetaceans* (1871); *Arrangement of the Families of Mollusks* (1871); *Arrangements of the Families of Fishes* (1872); *Arrangements of the Families of Mammals* (1872); *Catalogue of the Fishes of the East Coast of North America* (1875); *Bibliography of the Fishes of the Pacific Coast of the United States to the End of 1879* (1882); *Scientific and Popular Views of Nature Contrasted* (1882).

GILLAM, BERNHARD, an American cartoonist; born at Banbury, England, Oct. 28, 1856; when a child, he removed with his father, a furnaceman, to New York City, and became absorbed in art when he was 14 years of age. His start was accomplished by his approaching Henry Ward Beecher with a portrait of the great divine, who obtained for the diffident artist the privilege of exhibiting the portrait in the show-window of a popular Brooklyn store. Here he received, as a result, many orders for similar portraits. He secured a place on *Frank Leslie's Illustrated Weekly* in 1879; after the death of Mr. Leslie, went to the *Graphic*; and during the Garfield-Hancock campaign made cartoons for *Harper's Weekly*, being associated with the famous Thomas Nast. His work brought him into note, and he was soon on the staff of *Puck*, at the largest salary, it is alleged, ever earned by a cartoonist. Perceiving that there was room for another humorous paper of different politics, in 1886, with W. J. Arkell, he purchased *Judge*, which at once became very popular. After enjoying the success of his venture for ten years, Mr. Gillam died, prematurely, at Canajoharie, New York, Jan. 19, 1896.

GILLESPIE, WILLIAM MITCHELL, an American civil engineer and author; born in New York City in 1816; graduated at Columbia College in 1834; went to Europe, remaining ten years, and on his return in 1845, was appointed professor of civil-engineering at Union College, which position he retained until his death, which occurred at New York City, Jan. 1, 1868. His works include *Rome as Seen by a New Yorker* (1845); *Roads and Railroads* (7th ed. 1854); *Principles and Practice of Land-Surveying* (6th ed. 1858); and, edited by Cady Staley, a *Treatise on Levelling, Topography and Higher Surveying* (1871).

GILLET, EZRA HALL, an American author; born at Colchester, Connecticut, July 5, 1823; graduated at Yale in 1841, and at Union Theological Seminary in 1844, when he was ordained pastor of the Presbyterian Church in Harlem, New York, and in 1868 was appointed professor of political economy, ethics and history in the University of New York. He wrote much for various periodicals, and published *The Life and Times of John Huss* (1863); *Life-Lessons in the*

*School of Christian Duty* (1864); *History of the Presbyterian Church in the United States of America* (1864); edited *England Two Hundred Years Ago* (1866); *Ancient Cities and Empires* (1867); *God in Human Thought* (1874); *The Moral System* (1874); etc. He died at Harlem, Sept. 2, 1875.

GILLISS, JAMES MELVIN, an American astronomer; born in Georgetown, District of Columbia, Sept. 6, 1811; died at Washington, District of Columbia, Feb. 9, 1865. He entered the service of the United States navy in 1827. He became connected with the Coast Survey, organized the first working observatory in the United States in 1838; in 1842 superintended the construction of a naval observatory completed in 1845, and in 1848 went to Chile to make observations for the determination of the solar parallax, etc. Among his works are a report on astronomical phenomena observed in Chile, 1849-52, and on the total solar eclipse observed in Peru, September, 1858. In 1862 he was promoted to the rank of captain in the navy. He was one of the originators of the National Academy of Sciences.

GILLMORE, QUINCY ADAMS, an American soldier; born in Black River, Lorain County,



QUINCY A. GILLMORE.

Ohio, Feb. 28, 1825. He graduated at the United States Military Academy in 1849; was assigned to the engineers; served three years at Hampton Roads; appointed instructor at West Point, and later treasurer and quartermaster at the Academy, in which capacity he was serving at the outbreak of the Civil War. In 1856 he was promoted first lieutenant in the engineering corps; was appointed captain in 1861; engineer-in-chief of the Port Royal expedition under General Sherman; brevetted lieutenant-colonel United States army, in 1862. While on sick leave he assisted in organizing and forwarding to the front no fewer than sixty regiments of New York volunteers. He was assigned to important commands in Kentucky the same year; brevetted colonel in 1863; in June was given command of the Department of the South; a month later, of the Tenth Army Corps; was brevetted brigadier-general, and then made major-general of volunteers. He directed the operations against Fort Sumter, Fort Wagner and Battery Gregg; planted and operated the famous "Swamp Angel" on Morris Island, and won the praise of General Halleck for his scientific work. In 1864 he commanded the Tenth Army Corps on the James River; later commanded two divisions of the Nineteenth Army Corps, in the defense of Washington; and in 1865 was again in command of the Department of the South. Subsequently he was appointed engineer-in-chief of the fortifications and harbor and river improvements on the Atlantic coast south of New York. In 1863 he was promoted major; in 1874, lieutenant-

colonel, and in 1883, colonel. He was the author of several works on engineering, etc. He died in Brooklyn, New York, April 7, 1888.

GILL-OVER-THE-GROUND. See GROUND-IVY, in these Supplements.

GILMAN, a town of Iroquois County, northeastern Illinois, 81 miles S.S.W. of Chicago, on the Illinois Central, the Toledo and Warsaw and the Gilman, Clinton and Springfield railroads. It is in a corn region, but considerable fruit and stock are raised. It has a public library and a nursery, and manufactures tiles, linseed-oil, brooms, and cheese and butter. It is provided with city water. Pop. 1890, 1,112; 1900, 1,441.

GILMAN, ARTHUR, an American educator and author; born in Alton, Illinois, June 22, 1837; educated in St. Louis and New York, and received an honorary degree of master of arts from Williams College. In 1870 Mr. Gilman became connected with the Riverside Press at Cambridge, Massachusetts; and in 1871 became one of the editors of the American Tract Society. In 1876 he and his wife formulated a plan, which afterward developed into the Society for the Collegiate Instruction of Women, better known as the Harvard Annex. Mr. Gilman contributed to the periodicals and wrote many books on historical and literary subjects. He published *First Steps in English Literature* (1870); *History of the American People* (1883); *Rome from the Earliest Times to the End of the Republic*, in Story of the Nations Series (1885); *The Saracens, from the Earliest Times to the Fall of Bagdad*, in Story of the Nations Series (1886); etc. His most ambitious work is an edition of Chaucer, based upon the famous Ellsmere text.

GILMAN, CAROLINE HOWARD, an American authoress; born in Boston, Oct. 8, 1794. At the age of sixteen she wrote her first poem, entitled *Jephthah's Rush Vow*, and this was followed by *Jairus's Daughter*. In 1819 she married Dr. Samuel Gilman, and from that year until 1870 resided in Charleston, South Carolina, and then went to Cambridge, Massachusetts. From 1830 to 1839 she edited *The Rosebud* (afterward *The Southern Rose*), a magazine for children, from which were republished two volumes of *Recollections* and other selections, which became popular favorites. She died at Washington, District of Columbia, Sept. 15, 1888.

GILMAN, DANIEL COIT, an American educator, was born in Norwich, Connecticut, July 6, 1831; graduated at Yale in 1852. From 1856 until 1860 he was superintendent of schools in New Haven; state superintendent of schools in Connecticut (1865-66); librarian of Yale (1856-65); professor of physical and political geography at Sheffield Scientific School (1863-72); presi-



DANIEL COIT GILMAN.

dent of the University of California (1872-75); and in 1875 became president of Johns Hopkins University, in Baltimore, Maryland. He was elected to membership in various scientific societies, and was chosen president of the American Social Science Association in 1879; in 1876 he received the degree of LL.D. from Harvard, and from Columbia in 1887. President Gilman published many magazine articles, reports, and addresses. He prepared the biography of *James Monroe* for the American Statesman Series (1883); edited the writings of Francis Lieber (1881); and wrote *University Problems* (1898).

GILMAN, NICHOLAS PAINE, an American editor and author; born at Quincy, Illinois, Dec. 21, 1849; graduated at Harvard Divinity School in 1871; was a professor at Antioch College (1878-81); became editor of *The Literary World* (1888), and of *The New World*, Boston, in 1892. He was secretary of the Association for Promoting Profit-Sharing, and published *Profit-Sharing between Employer and Employee* (1889), advocating this system as "one of the most promising methods of securing the peaceful and fruitful union of the productive forces of modern industry."

GILMAN, SAMUEL, an American author; born at Gloucester, Massachusetts, Feb. 16, 1791; graduated at Harvard in 1811; studied theology; was for two years mathematical tutor in Cambridge; and in 1819 became, on his ordination, pastor of the Unitarian Church at Charleston, South Carolina, remaining there until his death, which occurred at Kingston, Massachusetts, Feb. 9, 1858. Many of his contributions to the magazines were collected and published under the title, *Contributions to Literature: Descriptive, Critical and Humorous, Biographical, Philosophical and Poetical* (1856). He was the author of *Memoirs of a New England Village Choir* (1829); *Pleasures and Pains of a Student's Life* (1852); and a poem, *The History of a Ray of Light*. He was a conspicuous worker in the temperance cause.

GILMER, GEORGE ROCKINGHAM, an American jurist; born in Wilkes (now Oglethorpe) County, Georgia, April 11, 1790; began the practice of law at Lexington; and in 1813 became a lieutenant in the Forty-third United States Infantry. This regiment served in the war with the Creek Indians, and was disbanded in 1815, after the war with Great Britain. After serving in the state legislature he was elected to Congress in 1821, as a Democrat; was again a member of the state legislature, and again in Congress (1827-29). He was governor of Georgia (1829-31); served in Congress (1833-35); and served a second time as governor (1837-39). He was a Presidential elector on the Hugh L. White ticket in 1836, and on the Harrison ticket in 1840. He was a trustee of Georgia University for thirty years, and was the author of *Georgians*, a work that furnishes details of the early settlers (1855). He died at Lexington, Georgia, Nov. 15, 1859.

GILMORE, JAMES ROBERTS, an American author; better known as "Edmund Kirke"; born in

Boston, Sept. 10, 1823. He became a partner in a counting-room before he was of age, and in 1848 became the head of a cotton and shipping firm in New York City, from which he retired before the beginning of the Civil War. In 1862 he founded the *Continental Monthly*, but soon discontinued his connection with it. In 1873 he again engaged in business, but retired in 1883, and devoted himself to literature. Among his books are *Among the Pines* (1863); *Adrift in Dixie* (1863); *My Southern Friends* (1863); *Down in Tennessee, and Back by Way of Richmond* (1864); *Patriot Boys and Prison Pictures* (1865); *Among the Guerrillas* (1866); *On the Border* (1867); *The Rear-Guard of the Revolution* (1866); *John Sevier as a Commonwealth Builder*, a sequel to the former (1887); *The Advance Guard of Western Civilization* (1888). In July, 1864, he, with Colonel Jaquess, was intrusted by President Lincoln with an unofficial mission to Jefferson Davis with the object of bringing about a peace, the mission eliciting from the Confederate government the declaration that no terms could be concluded which did not secure the independence of the Confederate States. This had the effect of obliterating the peace desire in the North. Lincoln offered Gilmore the post of minister to Switzerland, in acknowledgment of his services, but the office was declined.

GILMORE, PATRICK SANSFIELD, an American musical conductor; born near Dublin, Ireland, Dec. 25, 1830; was a member of the brass band at Athlone which played instrumental parts during mass at the Catholic Church. He proceeded to the United States in 1849, and soon became a band-master in Boston, playing in concerts and circuses. He went to Salem, where he remained four years, returning to Boston with the record of having successfully conducted over one thousand band concerts, and organized, in the latter city, in 1858, what became famous in America and Europe as Gilmore's Band. On the outbreak of the Civil War he and his men volunteered with the Twenty-fourth Massachusetts Regiment. In 1864 he was placed in charge of all the bands of the Gulf by General Banks. In 1869 and 1872 he organized the peace jubilee in Boston, the largest musical festival ever held, in which more than twenty thousand people and two thousand musicians, aided by some of the best military bands from Europe, took part. Mr. Gilmore removed to New York City, became band-master of the Twenty-second Regiment, and inaugurated the famous popular concerts which were given in Gilmore's Garden. During the Centennial Exposition in Philadelphia in 1876, his band furnished music daily in the Main Hall. In 1878 he gave concerts at the Paris Exposition, winning distinguished honors. During this year he visited most of the leading European cities. On his return to America, during several successive summers his band gave concerts at Manhattan Beach, Coney Island. In New York City his band of one hundred pieces ushered in the four hundredth anniversary of the discovery of America by Columbus, which celebration took place in front of the

City Hall, in the presence of an audience of thirty thousand people. He was chosen musical director of the World's Columbian Exposition, the appointment reaching him just two days before his death, and regarded by him the greatest honor any musician had ever received. Among his compositions are *Good News from Home*; *When Johnny Comes Marching Home*; *The Voice of the Departing Soul*; or, *Death's at the Door*; and the anthems *Columbia*, which he fondly hoped would become national, and *Ireland to England*. He died in St. Louis, Sept. 24, 1892.

GILPIN, HENRY DILWOOD, an American jurist and author; born in England, April 14, 1801; removed to Pennsylvania and practiced law in Philadelphia. He became successively United States attorney for Pennsylvania, solicitor of the Treasury, and in 1840 Attorney-General of the United States. By authority of Congress he supervised the publication of the papers of James Madison (purchased by the government from Mrs. Madison for thirty thousand dollars), which appeared in 1840. He wrote many biographies of the signers of the Declaration of Independence. He died in Philadelphia, Jan. 29, 1860.

GILROY, a city of Santa Clara County, central California, on the Southern Pacific railroad, 70 miles S.E. of San Francisco. The city is lighted with gas, supplied with good water, and has manufactories of flour and tobacco. It is surrounded by fertile land, and farming and dairying are carried on in the vicinity. Population 1000, 1,820.

GILTHEAD (*Sparus aurata*), a name often applied to a fish found in European and African seas, and allied to the scup of New England waters. The name is sometimes given to the connor (*Crenilabrus*) of United States coasts.

GIMBALS (Lat., *gemellus*, "a twin"), two circular brass hoops used for suspending the compass-box on board ship, so that it may always rest horizontally, unaffected by the ship's motion. The outer hoop is attached to a box or other fixed object, while the inner is constructed so as to allow it to move freely within the outer, to which it is attached by two pivots, at the extremities of a diameter. The compass-box is attached to the inner hoop by two similar pivots at right angles to the former. Thus the compass moves freely in two directions at right angles to each other, always retaining its horizontal position, however the vessel may roll or pitch.

GINGILIE-OIL, a name often given to the bland fixed oil obtained by expression from the seeds of *Sesamum Indicum*. See OILS, Vol. XVII, p. 746.

GINGKO, a large tree of the gymnospermous family *Taxaceæ*, with straight, erect trunk and conical head, and fan-shaped leaves somewhat notched at the end, long-stalked, smooth, yellowish green, with numerous minute dichotomously branching ribs. The fruit is a sort of drupe, about an inch in diameter. The nut, with thin shell and farinaceous kernel, is sold for food in China, resembling an almond in flavor, with a little mixture of sourness, which is removed by boiling or roast-

ing. It is called the maiden-hair tree, from the shape of its leaves, which resemble those of the maiden-hair fern, and is very commonly cultivated for ornament. The other members of this family are fossil, and this would probably have become extinct but for its cultivation in China and Japan, especially in the temple gardens, where it is regarded as a sacred tree.

GIOJA DEL COLLE, a commercial town of Italy, in the province of Bari, 23 miles S. of Bari. It is believed to have been founded in the sixth century, and very valuable Græco-Roman coins and ancient vases have been found in its neighborhood. Population, 14,213.

GIOLITTI, GIOVANNI, an Italian statesman; born in 1842; became a doctor of laws; was Director of Customs in 1876; entered Parliament in 1882; was Minister of Finance in 1890, under Crispi, but brought about the fall of the Crispi ministry, and became himself Premier in May, 1892, holding office until Nov. 25, 1893, when his ministry fell as a result of the Banco Romano scandal. Giolitti submitted, Dec. 15, 1894, to the Chamber of Deputies a sealed envelope containing charges apparently implicating Premier Crispi in the same affair. These charges were characterized by Crispi as a tissue of lies; and Giolitti afterward fled to avoid arrest, but returned to Rome, Feb. 27, 1895, to meet accusations brought against him of the abstraction of papers from the archives and of illegal possession of letters of Signor Crispi. Giolitti demanded trial by the Senate, and the court of cassation sustained his appeal. This practically had the effect of quashing proceedings against him.

GIOVANNI A' FEDUCCIO, SAN, a town in central Campania, Italy, three miles E. of Naples, situated near the seashore, in a fertile plain. Its neighborhood is well cultivated, and embellished with beautiful villas. Population, 11,116.

GIRARD, a city and the capital of Crawford County, southeastern Kansas, whose chief trade is with stock-raisers and farmers. It has good railroad facilities, being on five roads, among them the Atchison, Topeka and Santa Fé and the Kansas City, Fort Scott and Memphis railroads. It has coal-mines. Population 1900, 2,473.

GIRARD, CHARLES, a French naturalist; born at Mülhausen, Alsace, 1822; became an assistant to Agassiz at Neuchâtel, and followed him to the United States in 1847. Professor Girard was connected with the Smithsonian Institution for many years, and published numerous works on natural history, geology and other scientific subjects. His writings include *Essay on the Classification of Nemertes and Planariæ* (1850); *A Monograph of the Cottoids* (1851); *Contributions to the Natural History of the Fresh-Water Fishes of North America* (1851); *Contributions to the Fauna of Chili* (1856); *Herpetology of the United States Exploring Expedition, 1838-42* (1859).

GIRARD COLLEGE, an institution of learning, founded in Philadelphia by the philanthropist, Stephen Girard, "mariner and merchant," as he called himself in his will; for an account of

whom, see Vol. X, p. 621. The chief of his many benefactions was for the provision of a "permanent college" for educating and training "as great a number of poor male white orphan children as can be trained in one institution." He intended the college to accommodate at least three hundred children, and left the minutest

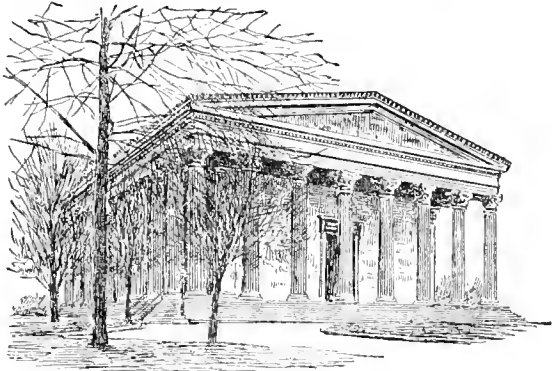

MAIN BUILDING, GIRARD COLLEGE, PHILADELPHIA.

instructions in his will for the construction of the buildings, which he desired to be absolutely fire-proof. The main building was erected in accordance with his design, and it is one of the finest specimens of Greek architecture in America (see ARCHITECTURE, in these Supplements). The provisions he made for the orphans to be admitted into the institution were that they—

"Shall be there fed with plain but wholesome food, clothed with plain but decent apparel (no distinctive dress ever to be worn), and lodged in a plain but safe manner. They shall have suitable and rational recreation and exercise. They shall be instructed in the various branches of a sound education, comprehending reading, writing, grammar, arithmetic, geography, navigation, surveying, practical mathematics, astronomy, natural, chemical and experimental philosophy, the French and Spanish languages (I do not forbid it, but I do not recommend the Greek and Latin languages), and such other learning and science as the capacities of the several scholars may merit or warrant. I would have them taught facts and things, rather than words and signs. And, especially, I desire that, by every proper means, a pure attachment to our republican institutions, and to the sacred rights of conscience as guaranteed by our happy constitution, shall be formed and fostered in the minds of the scholars."

The teachers were to be selected on account of their merit, and not through favor or intrigue. The scholars were, upon graduation, to be bound out as tradesman, according to the custom of the time. Then came the following provision, which has caused universal comment: "I enjoin and require that no ecclesiastic, missionary or minister, of any sect whatsoever, shall ever hold or exercise any station or duty whatever in the said college; nor shall any such person ever be admitted for any purpose, or as a visitor, within the premises appropriated to the purposes of said college." In making this restriction he did not mean to reflect upon any sect or person, but desired to keep the scholars and the institution "free from the excitement which clashing doctrines and sectarian controversy are apt to produce." The provision may be explained by

the fact that at the time the will was drawn sectarianism ran high in Philadelphia, and Girard's mind was directed to its baneful influences. The college prospered from the start. In 1832 the value of the estate left for its endowment amounted to between \$2,000,000 and \$3,000,000; in 1895 the total value of the college estate amounted to \$14,921,828, and the net income was \$1,050,880.22. The total number of scholars at the end of the year 1895 was 1,524. One of the excellent features of the college is its military discipline. The boys are under the instruction of a United States officer, and their training is complete and regular. Notwithstanding the apparently prohibitory provisions as to the exclusion of clerical persons, it is a remarkable fact that thorough religious instruction is given in the college, though by laymen, attendance on chapel and Sunday school being obligatory. Hundreds of applicants for admission are always on the waiting-list. The scope of the instruction keeps pace with modern requirements. Some of the nation's ablest men received their start at Girard College. See PHILADELPHIA, Vol. XVIII, p. 740.

GIRARDIN, ÉMILE DE, a French journalist and politician, the illegitimate son of General Alexandre de Girardin and Madame Dupuy. He was born in Paris, June 22, 1806. Until 1827 he bore the name of Delamothe. After 1827 he assumed the name of his father, who acknowledged him in 1847. His first attempt in literature was a novel, *Émile*, in which he pleaded the cause of illegitimate children. After the July revolution in 1830, he published the *Journal des Connaissances Utiles*, which soon attained a sale of 120,000 copies. In 1836 he founded the one-cent newspaper, *La Presse*, an Orleanist journal with a conservative tendency. As his rivals accused him of receiving subsidies from the government, he got into quarrel with Armand Carrel, editor of *La Nationale*, which culminated in a duel. Carrel was fatally wounded and died. After this Girardin occupied himself ardently with politics, both as a journalist and a Deputy, and gradually became a decided Republican. When Louis Napoleon was elected to the Presidency, Girardin promoted his cause; but he was strongly against the *coup d'état*, and was rewarded with a short period of exile. In 1856 Girardin sold his share in *La Presse*, but became its editor again in 1862. Soon afterward he became the editor of *La Liberté* and managed this paper till 1870. He excelled all his fellows in braggadocio on the outbreak of the Franco-Prussian war. In 1874 he founded *La France*, and both in its pages and in *Le Petit Journal* supported the republic. His political ideas were given to the world in a number of brochures. He died at Paris, April 27, 1881. In 1831 he married DELPHINE GAY. See GIRARDIN, MADAME ÉMILE DE, Vol. X, p. 621.

GIRNAR, a sacred mountain in eastern India, in the peninsula of Kathiawar, Bombay province, 10 miles E. of Junagadh. It is a bare pile of granite, rising to the height of 3,500 feet above the sea, and, as a holy place of Jainism, is covered

with ruined temples. One group contains 16 temples, nearly 3,000 feet above the sea.

GIRTY, SIMON, an American leader of Indians; born in Pennsylvania about 1750; was for several years a prisoner among Indians, and served under Lord Dunmore as a spy. In 1777 he joined the savages, who were aiding the British troops, became a leader, and won infamous notoriety by encouraging them to torture and murder their prisoners, among them Colonel William Crawford and General Richard Butler. It was variously believed that he was killed at the battle of the Thames in 1813, or died in Canada in 1815.

GIST, CHRISTOPHER, an American scout; born in North Carolina. He was employed as a surveyor by the Ohio Company to trace the course of rivers and mark the mountain passes of the northwestern territory. On Oct. 31, 1750, he crossed the mountains, and in 1751 reached the great Miami River. On March 1st of that year Gist descended the river to its union with the Ohio, ascended the valley of the Kentucky River, discovered a pass, and returned home by way of Roanoke. In 1753 Gist settled on a plantation in Pennsylvania, near the Youghioghny River. At the end of that year he acted as a guide to Washington, who had been sent by Governor Dinwiddie of Virginia to make a journey to Lake Erie. On their return the two were fired on by some Indians, but escaped unhurt. A fort was located where Pittsburg now stands, on the favorable report of the two travelers, which was taken by the French and named Fort Duquesne. From this point Gist's history is unknown.

GIUDICI-EMILIANI, PAOLO, an Italian author, born at Mussomeli, Sicily, June 13, 1819; died at Hastings, England, Sept. 8, 1872. At the age of sixteen he unwillingly entered a convent, where he devoted himself to the study of literature. He subsequently quitted the life of a recluse and fled to Tuscany, where he began his principal work, *La Storia della Letteratura Italiana*. About this time he received a legacy from his friend Emiliani, whose name he adopted, and was thus enabled to pursue his studies at leisure. He became professor in the University at Pisa in 1849, and in 1861 was made secretary to the Academy of Fine Arts in Florence, succeeding Niccolini, and in 1867 was elected to the Italian Parliament. Other of his writings are *Storia dei Municipii Italiani* (1851); and *Storia delle Belle Arti in Italia*.

GIULIANI, GIAMBATTISTA, an Italian scholar; born at Canelli, in Piedmont, June 4, 1818; died in Florence, Jan. 11, 1883. He was appointed professor of mathematics at the Clementine College at Rome (1837); then of philosophy at the Lyceum at Lugano (1839); of rhetoric at the University of Genoa (1848); and of Italian literature at Florence (1860). He made a profound study of Dante, and in 1845 published his celebrated *Saggio di un Nuovo Commento della Commedia di Dante Allighieri*. He was, for a time, censor of the press, and performed the duties of the office with much liberality. He published

many works concerning Dante and the Italian language, among them being *Sul Vivente Linguaggio della Toscana*; *Le Norme di Commentare la Divina Commedia*; and *Metodo di Commentare la Divina Commedia*. He also published a critical and annotated edition of all the works of Dante.

GIVIN, WILLIAM MCKENDREE, a United States Senator; born in Sumner County, Tennessee, Oct. 9, 1805; died in New York City, Sept. 3, 1885. His father was a Methodist clergyman. Young Givin received a good education, read law, and thereafter studied medicine, taking his degree in 1828. He went to Clinton, Mississippi, and was appointed, by President Jackson, United States marshal for the district of Mississippi. In 1840 he was elected to Congress. On the accession of President Polk he was appointed to superintend the building of the new customhouse in New Orleans. In 1849, on the election of General Taylor, he resigned his place to seek his fortune in California. Here he became at once active in favor of a state government, and was chosen a member of the convention held in Monterey to frame its constitution. In December, 1850, Dr. Givin was chosen United States Senator, was re-elected in 1854, and served until March 3, 1861. At the beginning of the Civil War he was arrested as a pronounced sympathizer with the Confederates and kept in durance until 1863. The following year he spent in Paris, in the interest of the Southern Confederacy. At the conclusion of the war, Dr. Givin returned to California.

GLACIAL DRIFT. See BOULDER-CLAY, in these Supplements.

GLADDEN, WASHINGTON, an American clergyman; born at Pottsgrove, Pennsylvania, Feb. 11, 1836; graduated at Williams College (1859); ordained pastor of the State Street Congregational Church in Brooklyn (1860), and was pastor in Morristania, New York (1861); North Adams, Massachusetts (1866-71); Springfield, Massachusetts, (1875-83); and of the First Congregational Church at Columbus (1883). He was on the editorial staff of the *New York Independent* (1871-75); editor of *Sunday Afternoon* (1878-80); and department editor of *Our Day*. He received the degree of D.D. from Roanoke College (1884), and LL.D. from the University of Wisconsin (1881). He published *Amusements: Their Uses and Abuses* (1867); *Plain Thoughts on the Art of Living* (1868); *From the Hub to the Hudson* (1869); *Working-People and Their Employers* (1876); *Being a Christian* (1876); *The Christian Way* (1877); *Was Bronson Alcott's School a Type of God's Moral Government?* (1877); *The Lord's Prayer* (1880); *The Christian League of Connecticut* (1883); *Things New and Old in Discourses of Christian Truth and Life* (1883); *The Young Men and the Church* (1885); *Applied Christianity* (1886); *Burning Questions on the Life That Now is and That Which is to Come* (1889); *Who Wrote the Bible?* (1891); and, later, *Tools and the Man; Property and Industry under the Christian Law*; and *The Cosmopolis City Club*.

GLADSTONE, WILLIAM EWART, a British statesman, orator and author, was born in Liver-



pool, England, Dec. 29, 1809, his father, Sir John Gladstone, being a well-known merchant of that city. Mr. Gladstone is of Scotch descent on both sides. He was educated at Eton, and at Christ Church, Oxford, from which he graduated in 1831. As a member of the Oxford Union De-

bating Society, he early showed his skill in dialectics, and gave promise of rare gifts as a debater and orator, which he was subsequently to manifest, in a remarkable degree, in moulding the political history of his country. From that mimic parliament he passed, in 1833, to the House of Commons, having been elected, in the Conservative interest, for the borough of Newark at the general election of December, 1832. Here, in the Reform Parliament of the era, he strengthened the Tory ranks by proving himself a strong opponent of all advanced measures of political reform, which he was, in later years, to espouse. So strong at this time was his Toryism, that we find him, in the Parliament that voted twenty millions sterling for the manumission of the slaves, if not hostile to their emancipation, at least opposed to an immediate and indiscriminate enfranchisement. In other respects the young orator made a favorable impression, the House being taken by his manner, as well as by his diction and fluency. His power as a debater, and even at this early stage of his career his parliamentary capacity, commended him to the notice of Sir Robert Peel, who, on taking office at the close of 1834, appointed Gladstone Junior Lord of the Treasury, and, after some shifting of the scenes, when Peel had formed a stable government, he offered Gladstone the offices of vice-president of the Board of Trade and Master of the Mint. He was at the same time (1841) sworn a member of the Privy Council, and, two years later, succeeded to the presidency of the Board of Trade.

In these several capacities, and at a time of great economical change, heavy were the burdens which fell upon Mr. Gladstone, in explaining and defending the policy of the government. The revision of the tariff of 1842 was almost entirely the result of his labors; and that it passed both Houses with but little alteration was due to its author's mastery of details, coupled with his knowledge of commercial affairs and their underlying economic principles. In 1845 he succeeded Lord Stanley (the late Earl of Derby) as Secretary of State for the Colonies; but owing to the attitude he assumed toward the religious questions of the time, and especially that of the Maynooth grant, he resigned office and his seat for Newark, and for a while remained out of Parliament. His reason for opposing, for a time, the

Maynooth College endowment was, that the proposed measure ran counter to the views he had enunciated in *The State in Its Relations with the Church*, a work from his pen, which he had just published, and which embodied much of the high religious Toryism that marked his opinions at this era. From this attitude he in time swerved, as he also swerved from the convictions which he early held on the subject of protection and other high-and-dry characteristics of the Tory reactionism of the period.

In 1847 Mr. Gladstone was elected to represent Oxford University in Parliament, a connection which he maintained without a break until 1865. The transition from the Tory to the Liberal now began to show itself, in his supporting the proposal to admit Jews to Parliament, in his defense of the free-trade policy of his chief, Sir Robert Peel, and advocacy of the repeal of the navigation laws, as well as in the change that came over his views on the colonial policy of the imperial country. His strong humanitarianism also began at this time to influence his political convictions, as his speeches in the session of 1850 manifest, during the debate on Greece and the claims of British subjects against that power, and in his strenuous remonstrances with the court of Naples on its inhuman treatment of political offenders.

Sir Robert Peel's death in 1850 paved the way for a still ampler career for Mr. Gladstone, and for greater successes as a Parliamentary debater. The first of his famous oratorical successes was gained in 1852, during the debate on Mr. Disraeli's budget of that year, which led to the defeat of the Derby-Disraeli ministry and the coming into power of Lord Aberdeen's coalition government of Whigs and Peelites. This was the beginning of the long rivalry in the political arena of the two great Parliamentary athletes,—Mr. Disraeli and Mr. Gladstone,—a rivalry which lasted for almost a quarter of a century. In Aberdeen's ministry, which lived on till the Crimean War broke up the coalition, Mr. Gladstone held the office of Chancellor of the Exchequer. During his period of office, he inaugurated a new era of finance in his first budget, by relieving the nation of much irritating taxation, and bringing forward, at the same time, a favorable scheme for the gradual reduction of the national debt. In Palmerston's administration (1855), Mr. Gladstone continued, for a few months, to hold the finance ministership, but resigned it, owing to the Premier's resisting Mr. Roebuck's motion for a Sebastopol inquiry, though he continued to give the government a general support. In the winter of 1858-59, he accepted, under Lord Derby's second ministry, a special mission to the Ionian Islands, to arrange certain difficulties which had arisen in the administration of that dependency, soon to be made over to Greece. Lord Palmerston having returned to power in 1859, Mr. Gladstone resumed his former post of Chancellor of the Exchequer, and brought forward one of his notable financial measures, giving effect to

the commercial treaty with France, and providing for the repeal of the paper duty, which the House of Lords, for a while, foolishly sought to veto. For some years his master hand guided the national finances, and brought an era of un wonted prosperity to the country. But one mistake he made at this period—a mistake which he afterward confessed to be an error of judgment—in his expressing his conviction, in a speech at Newcastle, that Jefferson Davis had succeeded in making the Southern States, then in revolt from the American Union, an independent nation.

Palmerston's death, in 1865, which called Lord John Russell to the Premiership, made Mr. Gladstone leader in the House of Commons. The general election of that year severed Mr. Gladstone's connection with the representation of Oxford University, and drove him to South Lancashire for a seat. In the following year Lord Russell's second administration was defeated in committee on its Reform Bill, and Lord John, with Mr. Gladstone and his colleagues, resigned. Mr. Gladstone's fight for reform was, however, not without effect, for Mr. Disraeli, in the incoming administration, introduced and carried a Conservative measure (the Reform Bill of 1867) which has since been expanded until it has become practically household suffrage in cities and boroughs. Mr. Disraeli, on his accession to office (1868), met defeat on Mr. Gladstone's resolutions in regard to Irish Church disestablishment, and Mr. Gladstone, in 1869, became, for the first time, Prime Minister. In the elections of that year he had lost his seat in South Lancashire, but was returned for Greenwich.

Ireland and Irish affairs now began to interest Mr. Gladstone, probably owing to the Fenian disturbances of 1867, and the rising discontent of the sister island in the United Kingdom. The immediate result was the Irish Church Disestablishment Act, "one of the most remarkable legislative achievements of modern times." This was followed by Mr. Forster's Elementary Education Act, by a measure (the Ballot Act) for the protection of voters, by an act to abolish religious tests at the universities, by the abolition of the system of purchase in the army, and by the Irish Land Act of 1870. But reform under Mr. Gladstone seemed to be going faster at this period than the House or the country cared to follow; consequently, his measure known as the Irish University Bill of 1873 was defeated by three votes, and Mr. Gladstone tendered his resignation. In the following year, when Mr. Disraeli came back to power, Mr. Gladstone withdrew from the leadership of the Liberal party and occupied himself, for a time, in literary and historical studies. Besides these interests, he embroiled himself in ecclesiastical controversy, chiefly with reference to papal infallibility, a dogma then enunciated at Rome, and against which he hurled his famous brochure, *The Vatican Decrees in their Bearing on Civil Allegiance*, and its complementary work, *Vaticanism: An Answer to Replies and Reproofs*.

Mr. Gladstone's polemical fervor, about this time (1876), broke into flame over the bloodshed in Bulgaria, and the atrocities committed by the Turks in the East. Happily, Russia interposed on behalf of the oppressed Eastern nationalities, and her sword effected what diplomacy had failed to accomplish. Throughout this and other disquietudes of the period Mr. Gladstone's voice and pen were potent agencies in turning the tide of public opinion against Mr. Disraeli's bizarre imperial policy, and, as the result of the revolution in political feeling, Mr. Disraeli (now Lord Beaconsfield) was beaten at the polls, and Mr. Gladstone and his Liberal Cabinet succeeded to office (1880), with an unprecedentedly large majority at their backs. The early sessions of the new Parliament were chiefly occupied with harassing legacies from its predecessor, and the rudely obtrusive Irish question, the wrangling over which made a mockery of the nation's great deliberative assembly. The refusal of the House to admit Mr. Bradlaugh as a member, without taking the conventional oath, served to augment the worries of the hour. Distress in Ireland added to the cup of Mr. Gladstone's troubles, since it emboldened the Irish Nationalists, incited by the Land League, to resort to acts of unseemly menace and rowdiness in the Commons, and to deeds of violence in Ireland, which reached a climax in the Phoenix Park murders (1882), and brought upon the ill-starred island the severities of the Coercion Act, and other repressive government measures for the prevention of crime. In spite of the turbulent state of the country and the seditious acts of Irish "Invincibles," Mr. Gladstone was able to put on the statute book his beneficial measure of a second Irish land bill, which, however, failed to please Mr. Parnell and his Home Rule following. The Boer war of 1880, and the Egyptian war of 1882, with its issuing conflict in the Soudan and the pitiful death of General Gordon, added further to the embarrassments of Mr. Gladstone's administration during the years 1883-85, though the routing of Arabi Pasha's forces by Lord Wolseley at Tel-el-Kebir and the chivalrous conduct of the British troops in the Soudan did much to placate aggrieved public opinion.

The sessions of 1884-85 were chiefly taken up with domestic legislation, and notably with a new Franchise Act—a bill for extending household franchise to the counties; and thus completing, as it has been said, the democratizing of the British constitution. With the Franchise Bill was coupled a new Redistribution Bill, a further beneficent measure of reform, both of which became law in 1885. Soon after these bills passed both Houses, Mr. Gladstone's second administration was overthrown by a vote on the budget, and Lord Salisbury succeeded, for a few months, to power. A division of the new House on an amendment to the address rendered the Salisbury administration a short-lived one, and Mr. Gladstone formed his third ministry, and signaled his return to power by declaring himself in favor of Home Rule,—a declaration which split the Liberal party in two



and curtailed his lease of office. On introducing his Home Rule bill (1886), its second reading in the House was rejected by a majority of thirty, and an appeal to the country was equally fatal to Mr. Gladstone and the measure. An overwhelming majority of Conservatives and Unionist Liberals was returned, and Lord Salisbury became, for the second time, Prime Minister, Aug. 3, 1886.

The issue of the elections, despite Mr. Gladstone's great and commanding personality, was, as a matter of course, bitterly disappointing to the Gladstonians and their redoubtable chief. It was, however, the penalty which their leader was to pay for his loyalty to the Irish cause,—a cause which, as has been shown, lost to the party many of its most influential members, who, under the name of Liberal-Unionists, now supported Lord Salisbury's administration, one of its number, Mr. Goschen, taking charge, in the Tory government, of Mr. Gladstone's old portfolio of the Chancellorship of the Exchequer. But Mr. Gladstone, as a Parliamentary tactician of the first order, pursued his course, heedless of recalcitrants, and stood firm in his resolve to befriend Ireland and do justice to her cause. He relaxed nothing of his activity, and continued ably to lead his party in opposition, until the wheel of fate turned once more in his favor, when he, in his eighty-third year, became, for the fourth time, Prime Minister. On Feb. 13, 1893, the "old Parliamentary hand" introduced a second Home Rule Bill, which, in character and scope, varied little from the earlier measure, save on the question of Irish representation at Westminster. On September 1st, the bill was at length passed by the Commons by a vote of 301 to 267. Seven days later, the measure having been forwarded to the Upper House, the Lords rejected it by a vote of 419 to 49.

This second defeat of Mr. Gladstone's chivalrous attempt to conciliate Ireland snapped the link which bound the great Parliamentarian to public life. The retirement of the illustrious leader of the Liberal party in modern England, though not unexpected, fell like a thunderbolt upon the country which had so long known his governing hand. To public regret at the occurrence was added much and kindly sympathy with Mr. Gladstone's failure of hearing and eyesight, which, for a time, painfully marked the strain which, of recent years, had been put upon him, as it marked the increasing infirmities of age. In Lord Rosebery he had named his own successor, and to his youthful colleague he confided the fortunes of his party, the veteran statesman finally withdrawing from political office. This act was followed by the relinquishing of his seat in Parliament, and by the announcement that he would not seek reelection.

Mr. Gladstone's retirement forms an epoch in English history; for, whatever may be thought of his Irish policy, or of the few mistakes he made in legislation, the abandonment of public life by one of the most illustrious of Englishmen, who for more than fifty years had taken a commanding part in the political affairs of the nation, could

not fail to leave its impress on the age. Nor was it remarkable that the event, when it took place, should become, for the time, the theme of world-wide comment, since Mr. Gladstone's figure is essentially a unique one in the history of the century. Indeed, were it possible to unite the combined talents of a score of the more prominent public men whom he left on the Parliamentary stage, one could not, as has been aptly said, make a Gladstone. Nor is there an enemy who would honestly question the purity of his motives, the beneficence of his acts, or the lofty elevation of his character. At times his hold upon the masses of his countrymen was extraordinary; and while the glamour of his name was always a potent force among his admirers, no one, of this age at least, surpassed him in the gifts of Parliamentary oratory, or was more effective as an expounder and debater. Added to all this, it must be said of him that he was on the whole the best representative of the English nation's political conscience, and an exalted type of its political morality.

But Mr. Gladstone's remarkable gifts were not alone political, although not always with the same success did he venture into other fields of labor, while bringing to his task his characteristic earnestness and industry. His contributions to literature covered a wide and varied field, and embraced disquisitions of much learning concerning Homer and Greek mythology, political treatises, essays in Biblical interpretation, tracts on ecclesiastical and theological subjects, together with autobiographical reminiscences and gleanings from a long, arduous, and active life. His chief published writings are *The State in Its Relations With the Church* (1838); *Two Letters on the State Persecutions of the Neapolitan Government* (1851); *Studies on Homer and the Homeric Age* (1858); *Financial Statements* (1863); *A Chapter of Autobiography* (1868); *Juventus Mundi* (1869); *The Vatican Decrees Bearing on Civil Allegiance* (1874); *Vaticanism* (1875); *Homeric Synchronism* (1876); *Bulgarian Atrocities* (1876); *Primer of Homer* (1878); *Gleanings of Past Years* (7 vols., 1879); *Special Aspects of the Irish Question* (1886); *Landmarks of Homeric Study* (1890); *Speeches* (1892); *The Romanes Lecture*, an academic sketch (1892); *The Impregnable Rock of Holy Scripture* (1892); a Letter on *Female Suffrage* (1892); an edition of Bishop Butler's Works, *Analogy and Sermons* (1896); *Subsidiary Studies to the Works of Bishop Butler* (1896); and an *Introduction to the People's Bible History*, an American work (1896). He died at Harwarden Castle, May 19, 1868; and was buried in Westminster Abbey with public honors.

G. MERCER ADAM.

GLAGOLITIC ALPHABET. See SLAVS, Vol. XXII, p. 150, and note.

GLAISHER, JAMES, a British meteorologist; born in London, of Scottish parents, April 7, 1809. In 1829 he was appointed assistant in charge of the meteorological observations on the mountains of Galway and Limerick; from 1833 to 1836 was assistant at the Cambridge Observatory; in 1836 was appointed assistant in the astronomical de-

partment of the Royal Observatory, Greenwich; and in 1840 was superintendent of the magnetical and meteorological department, created that year. He held this appointment until his retirement from public life in 1874, during which time he published quarterly and annual reports, compiled from the voluntary observations of about sixty meteorologists throughout England. In 1849 he was elected an F.R.S. He founded the Royal Meteorological Society, of which he was secretary and president in 1867. He was president of the Royal Microscopical Society and of the Photographic Society of Great Britain. He made 29 balloon ascensions for scientific purposes, in one of which he attained the greatest height ever reached, upward of seven miles. He published *Report on the Meteorology of London in Relation to the Cholera Epidemic of 1853-54* (1855); *Report on the Meteorology of India in Relation to the Health of the Troops* (1863); *Hygrometrical Tables* (1845); *A Memoir on the Radiation of Heat from Various Substances*, published in *The Philosophical Transactions* (1848); *Travels in the Air* (1871). He completed the calculations of the fourth, fifth, and sixth millions of the *Factor Tables*, begun in 1814 by Burckhardt, who calculated the first three millions, and which was continued, from the seventh to the ninth inclusive, by Dase, in 1862 and 1863, Mr. Glaisher publishing his three volumes to complete the work, in 1879-83.

GLANDS. See NUTRITION, Vol. XVII, pp. 671-667.

GLANIOSTOMI, an order of ganoid fishes, including the sturgeons (*Acipenseridae*). The barbels which surround the mouth suggest the name. The skin is armed with bony shields. The term is equivalent to *Chondrostei*.

GLASGOW, a town and the capital of Barren County, southwestern central Kentucky, on the Louisville and Nashville railroad, 32 miles E. of Bowling Green. It manufactures lumber, wagons, woodwork, tobacco and plows, and refines oil. It ships large quantities of oil, lumber and tobacco. Population 1900, 2,019.

GLASGOW, a city of Howard County, northern central Missouri, on the Missouri River, 72 miles above Jefferson City, and on the Wabash and the Chicago and Alton railroads. It has a public library, with 5,000 volumes, the Pritchett Institute and Morrison Astronomical Observatory. It is the shipping-point of the truck, tobacco and flour raised and made in the neighborhood. Population 1890, 1,781; 1900, 1,672.

GLASGOW. Little material change is to be noticed in the commercial metropolis of Scotland since the date of publication of the account found under GLASGOW, Vol. IV, pp. 638-646. The census of 1891 returned the population of the Parliamentary burgh as 564,981. The Redistribution of Seats Act assigned seven members of Parliament to Glasgow, the divisions each returning one member being Blackfriars and Hutchestoun, Bridgton, Camlachie, Central, College, St. Rollox and Tradeston. A new bridge across the Clyde at Rutherglen was commenced June 13,

1895. It has 3 arches, the center one with a span of 100 feet, and cost \$320,000. A central railway (underground) was opened for traffic Nov. 1, 1895, designed to afford rapid transit to all parts of the city. Four basins and a graving-dock at Cessnock, costing \$6,250,000, were rapidly nearing completion in 1896. The water-works system was improved with a new reservoir at Craigmaddie, having an area of 86¼ acres and a storage capacity of 700,000,000 gallons. The water comes from Loch Katrine. In 1893 the buildings and grounds of the University of Glasgow were enlarged by the addition of North Park House and grounds for the use of lady students. A chair of naval history was added in 1883, and one of history and pathology in 1893. In the matter of municipal good government, Glasgow takes high rank, and in no respect more so than in relation to street-cars. The first lines were opened in 1872, and the lease then made terminated in 1894. By its terms, the company was required to pay the corporation (1) the annual interest charge on the full amount of the city's investment; (2) a yearly sum for a sinking-fund large enough to clear the entire cost of the lines at the expiration of the lease; (3) a renewal fund of four per cent per annum on the cost of the lines, out of which they were to be kept in condition, and reserved to the city in perfect order and entirely as good as new in 1894; and (4) a mileage rental of \$750 per street mile. The total capital invested by the city in this enterprise was about \$700,000. The sinking-fund amounted to a little more than \$1,000,000, which covers cost of the original system. There remained the cost of newer lines. The renewal fund placed the system in perfect repair, and the city received in rental money a sum amounting to about \$225,000. The company, in the mean time, earned good dividends and paid off its indebtedness. In 1896 the tramways of Glasgow yielded the municipal treasury a large income, and required no public expenditure.

GLASGOW UNIVERSITY. See UNIVERSITIES, Vol. XXIII, pp. 843, 854.

GLASS (see GLASS, Vol. X, pp. 647-673) is now manufactured in the United States as follows:

The value of the annual production of all kinds is about \$25,000,000. In hollow-ware articles there is very little foreign competition, because buyers of bottles usually have special molds, and find it more convenient to buy from near-by manufacturers. Only the fancy cologne and cut-glass caster-bottles, decanters, etc., are imported, chiefly from France. Of common drug-gists' ware, as prescription-bottles, stoppered bottles and graduated bottles, the United States exports largely to England, and to some extent, also, to France.

Of table-glass, the United States produces articles fully equal to the English and French, except in a few styles.

In window-glass (not plate) the American manufacturers command the market, except where the English crown-glass and the cheapest styles of

German window-glass are yet preferred. In fine plate-glass, glass for optical instruments and Bohemian glassware, the French, English and German manufacturers are considerably ahead of the Americans. Yet there is something like \$2,500,000 worth of these kinds of glass produced yearly in this country.

The chief centers of the manufacture of glass in the United States are western Pennsylvania and southern New Jersey. Of the Pennsylvania glass about sixty-five per cent comes from Allegheny County, chiefly from Pittsburg. There are also glass factories at several places in New York state, at Lenox, Massachusetts; New Albany, Louisville and Jeffersonville, Indiana; Findlay, Ohio, and at Crystal City and St. Charles, Missouri.

Pressed-glass made by means of a lever-press is an American invention, first introduced at the Centennial Exposition in Philadelphia in 1876. It has enabled manufacturers to offer, for common use, glassware of graceful forms and beautiful designs, in imitation of the more costly cut-glass.

The sand-blast is now much used in carving, edging and drilling glass. The invention of this process has added greatly to the economical uses of glass. By its means glass can be cut in any form, holes drilled in it, figures edged or carved on it in low or high relief, etc. As a consequence, plate glass is largely introduced in more recent furniture, as for small shelves at bank-tellers' desks, cashiers' desks in stores, in ticket-offices, in hand-mirrors, as dial-plates in clocks, for door-panels, etc. These various new applications cause a steady increase in the manufacture of the finer qualities of plate-glass in America. In 1875 there were but two plate-glass factories in the United States. In 1886 the Pittsburg Plate Glass Company built the Tarentum works, and in 1890 the Ford City works, these being the largest factories of the sort in the world. In 1895 the output of American plate-glass was 18,000,000 square feet of merchantable glass.

The introduction of natural gas worked great changes in the Pittsburg field between 1883 and 1885, all the hollow-ware factories finding it an economy to use the new fuel. In the melting-furnaces gas is introduced at each end of the furnace, and mixes with air, which has previously been heated by passing through flues in the brickwork. The combustion, taking place in the melting-chamber, produces an intense and easily regulated heat. The blowing-furnaces make use of a large form of Bunsen burner. Since 1885 most of the window-glass factories in the gas-field have also made use of the natural gas.

The Siemens tank-furnace, for replacing the pot-furnace, has been the principal mechanical improvement introduced within the past decade. It is now used by the larger factories in south Jersey. Many manufacturers there, finding themselves at a disadvantage in competing with the factories in the natural-gas region, have tried petroleum as a fuel, and find it economical in the glory-holes for

melting and for annealing. There is, also, an unmistakable tendency toward new machine processes to supplant hand-work.

C. H. COCHRANE.

**GLASS, LUMINOUS.** In the manufacture of luminous glass, a phosphorescent powder is mingled with the glass while in a fused state, in the proportion of five to twenty per cent of mass of glass. After the composition has been duly puddled or mixed, it is converted into different articles by the ordinary processes. While the material is still warm and plastic, it is sprinkled with the powder, which becomes readily incorporated into the surface of the article by pressure, and the constant effect of luminosity or iridescence is readily produced.

**GLASS, WIRE,** the common name given to an article of manufacture consisting of a combination of wire-netting and glass. The process known as the Schuman process was patented in 1892. In this process there are four rollers which pass over the molten glass, which is poured on a table fixed in the floor. The rollers pass over the glass successively, the wire-netting, however, being fed in automatically between the first and second rollers. The wire-netting is heated red-hot, slides down an inclined iron table and is pressed deep into the glass by the second roller that follows. The third roller smooths the glass over the wire, and the fourth roller prevents the glass from curling up behind the roller in front. The next process is annealing, after which the glass is trimmed.

**GLASS-CRABS,** a name applied to the transparent larvæ of certain tropical marine crustacea, particularly to the larvæ of the spiny lobster, *Palaemonurus*, and its allies. These larvæ were formerly supposed to be adult forms, and were placed in the separate genus, *Phyllosoma*.

**GLASSITE DENOMINATION.** See GLASS, JOHN, Vol. X, p. 637.

**GLASS-SNAKE.** See LIZARD, Vol. XIV, p. 735.

**GLASS-SPONGE,** the common name of the sponges of the family *Hexactinellidae*. The skeleton consists of silicious six-rayed spicules united into a lace-work. Some forms have long glass filaments, which serve to anchor the animals. Most of the species of glass sponges are fossil. Among the living forms may be mentioned the "Venus's flower-basket" (*Euplectella*) and the common glass-rope sponge (*Hyalonema*). Both are from the deep waters of the Indo-Pacific. See SPONGES, Vol. XXII, p. 421.

**GLASSWORT,** a common name given to species of *Salicornia*, a genus of *Chenopodiaceae*, common in salt-marshes. Several species grow abundantly on the shores of the Mediterranean, and as they contain a large quantity of soda, were formerly of importance in making *barilla*, along with the species of saltwort. *S. herbacea* is the common species of the United States, being a low, leafy, fleshy and jointed plant, with flowers sunken in the fleshy spikes.

GLAUCOMA, a disease of the eyeball. See OPTHALMOLOGY, Vol. XVI, p. 783.

GLAUCONITE, a mineral found in Tertiary greensands and chloritic marls. Its composition is: Silica, 46 to 56 per cent; ferruginous oxide, 20 to 25 per cent; potash, 5 to 13 per cent; water, 0 to 10 per cent. See MINERALOGY, Vol. XVI, p. 415.

GLAUX, a genus of primulaceous plants, represented by a single species, *G. maritima*. It is a little, fleshy perennial, growing in saline localities in Europe, Asia and North America, and is often called sea-milkwort.

GLAVE, EDWARD JAMES, a young English explorer of African wilds, identified with Stanley's later journeys. After persistent application, in 1883 he joined Stanley at Leopoldville, on the Lower Congo, and, being filled with indomitable courage and an instinctive love of adventure, by his own choice was assigned to the wildest district in the country, with the object of establishing a new station, remaining for three years, until the Congo Free State was founded. Having successfully performed this arduous task, he returned to England, remaining, however, but a few months, when he joined the Sanford exploring expedition, establishing himself one hundred miles beyond his former station. During this experience he dwelt among the most savage cannibalistic tribes and murderous Arab slave-dealers without a single white companion. Again he returned to England in 1889, and shortly after visited America on a lecturing tour. In 1890 he conducted an expedition to Alaska, penetrating into an unknown interior, with but a single companion, his pack-horses being furnished with snowshoes, and the trip marked by many exciting incidents, afterward described in the *Century Magazine*, September, 1892. His final journey was undertaken in the interests of that periodical, Mr. Glave, in May, 1893, sailing for Zanzibar in order to traverse Central Africa by way of the Great Lakes and the Congo. After incredible hardships the young explorer neared the mouth of that river, when, at the missionary station of Underhill, he was stricken with fever, to which he shortly succumbed, dying in May, 1895. Thus ended a career replete with manly daring, and no less with exalted endeavor, it being Mr. Glave's paramount object to enlighten the civilized world regarding the iniquities of the African slave trade. He was a man of rare sweetness and nobility of nature, eliciting the most implicit trust from his native followers, and from Stanley the warmest friendship and admiration.

GLEDITSCHIA, a genus of leguminous trees, of which there are five or six species of North America, northern Asia and Africa. It is represented in the United States by the honey-locust or three-thorned acacia (*G. triacanthos*), and by the water-locust (*G. aquatica*). The former is a large tree, having compound leaves, large flat pods filled with a sweet pulp between the seeds, and inconspicuous flowers. It is widely cultivated for shade and as a hedge-plant. The timber is hard

and durable. The other North American species is a smaller tree growing in swamps in the Eastern United States.

GLEIG, GEORGE ROBERT, a Scotch clergyman and author; born at Stirling, April 20, 1796. After being educated at Glasgow and Balliol College, Oxford, he served under the Duke of Wellington, in Spain, in 1813. In 1814 he also served in America, but was wounded at the capture of Washington. Returning to England, he graduated at Oxford and took ecclesiastical orders. He became curate of Ash in 1822, and afterward rector of Ivy Church. In 1846 he was appointed chaplain-general of the army, which office he resigned in 1875. In 1848 he became a prebendary of St. Paul's. As he interested himself in the education of the soldiers, he was also made inspector-general of the military schools. Gleig tells his early adventures in an amusing book, *The Subaltern* (1825). He was the author, also, of *History of the Bible* (1830); *British Military Commanders* (1831); *History of British India* (1831); *Life of Sir Thomas Munro* (1849); *Memoirs of Warren Hastings* (1841); *Military History of Great Britain* (1845); *Story of the Battle of Waterloo* (1847); *Life of Lord Clive* (1848); *India and Its Army* (1857); *The Life of the Duke of Wellington* (1862); *Life of Sir Walter Scott* (1871); *History of the Reign of George III to the Battle of Waterloo* (1873); etc. He died at Winchfield, Hampshire, July 9, 1888.

GLENCOE, a village and the capital of McLeod County, south-central Minnesota, situated on Buffalo River, and on the Chicago, Milwaukee and St. Paul railroad. It has a seminary, grain-elevators, and plenty of water and timber. Its activity is chiefly commercial. Population 1890, 1,649; 1900, 1,780.

GLENCOE, a valley in Argyleshire, Scotland, the scene of a brutal massacre of the Clan Macdonald, by Captain Campbell of Glenlyon and 120 men, on the night of Feb. 1, 1692, after they had been hospitably entertained by McIan, chief of the clan. Sixty men were slaughtered; three fourths of the members of the clan in the glen fled, but many of the women and children perished in the violent snowstorm that was raging at the time. The massacre was the result of vengeful resolve on the part of the Master of Stair, who took advantage of the technical fact that the submission of the clan to William and Mary had been, by intrigue, delayed, and not received until January 6th, which was six days after the time arranged for receiving the submission of the recalcitrant clans. In consequence of this Stair induced the king to grant a warrant for the "extirpation" of the clan, which was intrusted to Campbell of Glenlyon, and literally carried out, as stated. See SCOTLAND, Vol. XXI, p. 518; and STAIR, Vol. XXII, p. 445.

GLENDIVE, a village and the capital of Dawson County, northeastern Montana, on the Yellowstone River and on the Northern Pacific railroad, 78 miles N.E. of Miles City. It has steamboat traffic on the river, and ships grain and stock, ex-

tensively raised in the vicinity. Population 1896, about 1,200.

**GLENS FALLS**, a village of Warren County, central eastern New York, on the Hudson River, and on the Delaware and Hudson railroad, 9 miles S. of Lake George. It has a famous cave, lime, black marble, water-power, water-works, an electric street-railway, and electric-light plants, gas-works, soldier's monument, two opera-houses, Glens Falls and St. Mary's academies, and a ladies' seminary. Its manufactories include an iron foundry, machine-shops, paper-mill, stone-sawing mill, brick and terra-cotta works, lime-kilns, and several turning, planing and saw mills. Population 1890, 9,509; 1900, 12,613.

**GLENWOOD**, a city and the capital of Mills County, southwestern Iowa, on Key Creek, and on the Chicago, Burlington and Quincy railroad, 9 miles E. of Plattsmouth, Nebraska. Its principal industry is the canning and shipping of vegetables and fruit raised in the vicinity. It has city water from an artesian well, and has electric lights. Population 1890, 1,890; 1900, 3,040.

**GLENWOOD SPRINGS**, a village and the capital of Garfield County, northwestern Colorado, at the junction of the Eagle and Grand rivers, on the Colorado Midland and the Denver and Rio Grande railroads, 60 miles W.N.W. of Leadville. It has thermal springs, which are resorted to by numbers of health-seekers. Coal and iron ore are plentiful. It is the supply-point for the Grand River Valley. Pop. 1900, 1,350.

**GLIOMA**. See **OPHTHALMOLOGY**, Vol. XVI, p. 784.

**GLIRES**, a Linnæan name, equivalent to *Rodentia*. See **MAMMALIA**, Vol. XV, pp. 415-420.

**GLISSON**, FRANCIS, an English anatomist; born at Rampisham, Dorsetshire, in 1597; graduated at Cambridge and Oxford; in medicine, at Cambridge, in 1634; and became professor of anatomy in the College of Physicians in London. He was distinguished as an investigator, and discovered and described a structure named after him, "Glisson's capsule," a sheath of areolar tissue surrounding the branches of the portal vein, the hepatic artery and the hepatic duct. He died in London, Oct. 14, 1677. See **ANATOMY**, Vol. I, p. 811; and **PATHOLOGY**, Vol. XVIII, p. 373.

**GLISSON**, OLIVER, an American naval officer; born in Ohio in 1809; entered the navy in 1825; was promoted through the various grades to commander in 1885; captain in 1862; commodore in 1866; rear-admiral in 1870, and was retired in 1871. He was on sea duty 22 years. In 1862 he commanded the steamer *Mount Vernon* of the North American blockading squadron, and saved the transport *Mississippi*, which had run aground on Frying Pan Shoals, off the coast of North Carolina, with General Butler and fifteen hundred men on board. He commanded the steam-sloop *Mohican* in pursuit of the privateer *Alabama*, and took part in the attacks on Fort Fisher (December, 1865, and January, 1866), commanding the third division of the fleet. Afterward he commanded the League Island station and as rear-

admiral the European squadron. He died at Philadelphia, Nov. 20, 1890.

**GLOAG**, PATON JAMES, a Scotch clergyman; born at Perth, May 17, 1823, educated at the universities of St. Andrew's and Edinburgh, and afterward occupied various pulpits. He wrote *On the Assurance of Salvation* (1853); *The Primeval World* (1858); *Practical Christianity* (1866); *A Critical and Exegetical Commentary on the Acts of the Apostles* (1870); *Introduction to the Pauline Epistles* (1874); *The Messianic Prophecies* (1879); *The Life of Paul* (1881); *Exegetical Studies* (1884); *Introduction to the Johannine Writings* (1891); *Subjects and Modes of Baptism* (1891); *The Life of St. John* (1892); etc.

**GLOBE**, THE RELIEF (or "Model of the Earth"), gives a representation of the solid earth as it would appear if all its water were removed. It shows not only the continents and islands as defined by their coast-lines, but their forms under water, and the varying depths of the ocean-bed. The globe was invented by Thomas Jones of Chicago.

This globe is strictly a model, or the solid earth (with all its water removed) in miniature, and is without mathematical lines or political boundaries, but accurately represents all mountain chains, plateaus, river systems, lake regions, and valleys and depressions.

"The Model" shows that the bases of continents as revealed by soundings have outlines quite different from the coast-lines as shown by maps, because outside of the coast-line is shown the "continental shelf," or that part of the seabottom which lies between the shore and the line of one-hundred-fathom soundings, from which the descent to the deep ocean-bed is more or less abrupt.

It shows such peculiarities of the ocean-bed as the banks of Newfoundland; the central ridge which traverses the basins of the North and South Atlantic, the plateau upon which the North Sea rests; the upward slope of the Arctic basin from a depth of 15,900 feet off the coast of Greenland to only 162 feet depth at Bering Strait. It shows, in the bed of the Pacific, great submarine plateaus, which, in places, approach within six hundred feet of the surface; also such great depressions as the trough between Kamchatka and Japan, where the profound depth of 27,930 feet was found by the United States ship *Tuscarora*. It also shows, as a startling contrast, that the bed of the Sea of Okhotsk (lying just westward) rises 27,300 feet above the great trough mentioned. The depths of the ocean are taken from soundings made by expeditions sent out by the United States and the governments of Europe.

"The Model" is regarded as a new and scientific departure in the study of physical geography, being helpful not only to the beginner and student, but to the scientist. It has been adopted by Cornell College and many other educational institutions, and the Royal Geographical Society of London has given it a prominent place in their map-room. The scale of height and depth upon

the "Model" is necessarily different from the distance scale, for if shown in actual proportion, the differences of elevation and depression would be too slight for touch or perception. It is made of pure copper, is twenty inches in diameter, and mounted upon a stand. The finish of the oceanbeds is light copper bronze; that of the land bodies, a greenish bronze.

**GLOBE-AMARANTH**, a name given to *Gomphrena globosa*, an Oriental plant of the family *Amaranthaceæ*, or amaranths. It is a low-branching plant, with oblong leaves, and dense, round heads of crimson to white flowers. It is also known as bachelor's-buttons. Several species of *Gomphrena* are natives of the Mexican border region.

**GLOBE-FLOWER**, the common name of *Trollius*, a small northern genus of *Ranunculaceæ*, with a globe-like cluster of large, showy sepals inclosing the small, inconspicuous linear petals. The common yellow globe-flower (*T. Europæus*) is one of the finest ornaments of moist grounds in elevated districts of northern Europe and in the Alps. It is cultivated in flower-gardens. The orange globe-flower (*T. Asiaticus*) is also common in gardens. *T. laxus*, the species indigenous in North America, and found in northern and high mountain swamps, has spreading and pale sepals, so that its flower by no means resembles a yellow globe, as in the first-named species.

**GLOBIGERINA OOZE**. See FORAMINIFERA, Vol. IX, pp. 378, 379.

**GLOBULINS**, a group of proteid substances closely allied to albumen, but differing from it in that they are not soluble in water unless it contains a small proportion of a neutral salt, and that they are precipitated by carbonic acid, and (except vitellin) by a saturated solution of common salt. The most important globulins which occur in animal tissue are: Globulin (proper) or crystallin, in the crystalline lens of the eye; fibrino-plastin, or paraglobulin and fibrinogen in blood, serous fluids, etc.; myosin, in muscle; vitellin, in the yolk of egg. Precisely similar bodies occur, also, in the vegetable kingdom.

**GLOMMEN**, the largest river of Norway. See NORWAY, Vol. XVII, p. 575.

**GLORIOSA**, a genus of *Liliaceæ*, of which the best-known species, *G. superba*, a native of India, is a herbaceous perennial with a weak stem, alternate simple leaves terminating in tendrils, and very beautiful flowers finely colored with red and yellow. The rootstock is poisonous, but is washed for its starch-like manioc.

**GLORIOSO ISLANDS**, a small group 120 miles N.W. of the northern end of Madagascar, not permanently inhabited, claimed by Great Britain.

**GLOUCESTER**, a city and port of entry of Essex County, northeastern Massachusetts, 28 miles N.E. of Boston, situated on the south side of the peninsula of Cape Ann, and connected by railroad with the principal cities and towns of the seaboard and interior. It is supplied with city water, electricity and gas, and has large hotels for summer guests, as it has a splendid beach, and is

quite a resort. Its interests are almost entirely commercial. No town in the United States is so largely engaged in domestic fisheries, the tonnage aggregating at least 35,000 tons, the vessels being over 400 in number, and the "catch" amounting in favorable seasons to 10,000,000 pounds. There are 5,000 men employed in mackerel and cod fisheries. Situated here is a United States piscicultural station. Of the ports of Massachusetts, only Boston surpasses Gloucester in foreign imports. The harbor is one of the best on the coast, and is accessible at all seasons for vessels of the largest class. The capital invested in manufactures here is about \$3,000,000. These employ, on an average, 2,000 persons, who receive \$900,000 in wages annually. The value of the products amounts to about \$5,000,000 annually. Of these industries the most important, after the fisheries, are the manufactures of mullage and paste, nets and seines, awnings, tents and sails, and granite-quarrying. Gloucester was occupied as a fishing-station as early as 1624, being the first settlement made on the north shore of Massachusetts Bay. Population 1890, 24,651; 1900, 26,121. Ever since 1765, when it was 3,763, the population has been steadily though slowly increasing. See also Vol. X, pp. 691, 692.

**GLOUCESTER CITY**, Camden County, southwestern New Jersey, on the Delaware River, and on the Atlantic City and the West Jersey railroads, three miles S. of Camden. It is connected by steam-ferry with Philadelphia. Gingham, print-cloths and calicoes are made here. The cotton-mills here employ over 1,200 hands. It is also extensively engaged in river and bay fishing. It has fair-grounds and a race-track, which are much used. Population 1880, 5,347; 1890, 6,564; 1900, 6,840.

**GLOVERSVILLE**, a city of Fulton County, central eastern New York, situated on the Cayadutta River. It was incorporated a city in 1890. A board of trade was organized in 1889. There are sixty miles of streets, mostly broad, and paved with cedar blocks, the principal ones being traversed by horse-cars. The Fonda, Johnstown and Gloversville railroad passes through the city, and connects with the New York Central and West Shore roads, and with the Erie canal at Fonda. The water-supply is abundant, brought by gravity from reservoirs three miles from the city. The fire and police departments are efficient. The assessed valuation of the city in 1890 was \$4,000,000, with no city debt. There is one national and one private bank, and a building and loan association. Two electric plants furnish lights for the streets and business houses and power for manufacturing purposes. In the department of education the citizens have been provided with good opportunities. The Union Free School building, erected in 1888, is a substantial three-story edifice. There is a free library containing 9,000 volumes, and a reading-room with daily and weekly papers and magazines. A great variety of industries is carried on here, and the city is particularly noted for the manufacture of buckskin and other gloves

and mittens, the annual product of the manufactory being valued at over \$15,000,000. Population 1880, 7,133; 1890, 13,864; 1900, 18,349.

**GLOW-WORM.** See PHOSPHORESCENCE, Vol. XVIII, p. 814.

**GLUCOSE, STARCH OR GRAPE SUGAR.** (See GLUCOSE, Vol. X, p. 695.) The term *grape sugar* is often restricted to the solid varieties of the sugar made from corn-starch, while the liquid varieties alone are designated "starch sugar" or "glucose." The manufacture of glucose has long flourished in Europe.

In America this industry has only recently been introduced; and, in spite of the prejudice as to the healthfulness of glucose, its manufacture has spread so rapidly that there are over thirty factories in the United States, capable of using about 50,000 bushels of corn per day. When corn is low in price, and cane sugar, molasses and barley are high, all the factories are in full operation. When the opposite conditions prevail, all the glucose factories are idle. The glucose of commerce is thick and tenacious, of a slightly yellowish tint, although nearly colorless, and with a specific gravity, at 20° C. or 68° F., of 1.412. Its sweetness varies with different specimens. If the manufacture has been well conducted, grape sugar made from corn-starch is, when new, of a pure white color, but gradually assumes a yellowish tint. It is hard and brittle, and dissolves more slowly in water than cane sugar. Of the two, cane sugar is the sweeter, while grape sugar leaves a faint but perceptible bitter taste in the mouth.

Glucose is chiefly used in the manufacture of table-syrups and confectionery, in the brewing of beer and ale, and in the manufacture of artificial honey. Sometimes it is also used as food for bees. Brewers conceal the fact of its employment, and confectioners do not like to speak of their use of glucose. For making artificial honey, the combs are manufactured of paraffine, and their cells filled with pure glucose by machinery. It looks white and inviting, but is less sweet than genuine honey. As it can be sold at less than half the price of the genuine article, and sweetened by the addition of cane sugar, a good deal of artificial honey has been manufactured. In the form of bleached grape sugar, glucose was formerly mixed with table-sugar. It is also used in the manufacture of condensed milk.

In 1884 a committee of the National Academy of Sciences submitted a report on glucose, in response to a request made by the Commissioner of Internal Revenue. Their report declared that the sweetening-power of grape sugar is about two thirds that of cane sugar. Many experiments were made by the committee with reference to the healthfulness of glucose, on account of the sulphuric acid used in its manufacture, it being taken internally in various conditions; in all cases it was found to be harmless and unobjectionable.

**GLUCOSIDES.** See CHEMISTRY, Vol. V, p. 572.

**GLUE, MARINE,** a cementing composition used in ship-building for covering seams in ships' decks after being calked. In hot climates it is preferred

to tar for this and other purposes, where the materials are exposed to the influence of the wet. It consists of India rubber cut very small, and digested at a gentle heat in a closed vessel with coal-tar naphtha until it is dissolved, when powdered shellac is added, and the digestion continued until it is also dissolved.

**GLUME,** a term applied to the characteristic scale-like bracts in the inflorescences of grasses. The inflorescences of sedges are also sometimes spoken of as *glumaceous*, but their glume-like bracts are usually called *scales*.

**GLYCOGEN.** See NUTRITION, Vol. XVII, pp. 680-682.

**GLYCOSURIA.** See DIABETES, Vol. VII, p. 147.

**GLYPTODON,** an extinct armadillo. See MAMMALIA, Vol. XV, p. 388.

**GMEIINA,** a genus of Oriental trees, of the family *Verbenacea*, or vervains. They furnish fine timber, resembling teak, but closer in grain, and lighter.

**GMUNDEN,** a town of Upper Austria, 159 miles W. of Vienna by rail. It lies 1,439 feet above sea level, amid the grandest scenery of the Salzkammergut, at the lower end of the Traunsee, or Lake Gmunden, above which towers the Traunstein. With numerous hotels and villas, it is a favorite summer bathing-place. Salt-mines employ many of the inhabitants. Population, 6,631.

**GNEISS.** See GEOLOGY, Vol. X, p. 236.

**GNEIST, RUDOLF VON,** a German jurist; born in Berlin, Aug. 13, 1816; died there, July 21, 1896. He studied jurisprudence at Berlin. In 1841 he was made assessor in the superior court (Kammergericht), and was successively assistant judge of the same court and of the supreme tribunal, until, in 1850, he resigned these positions in order to devote himself exclusively to teaching law. From 1867 to 1884 he was a member of the Prussian Lower House; in the Imperial Parliament he sat from 1875 to 1877. In 1875 he was called to the bench as a senior judge of the Supreme Court of Prussia and a member of the Privy Council. In the Prussian Chamber of Deputies, acting with the National Liberals, and in the Imperial Parliament, he advocated a greater amount of self-government of the people, more attention to the welfare of the working-classes, reform of the judicial and penal systems and the adoption of more liberal usages, like those in England. He was nominated by Emperor William I instructor to Prince William, now William II of Germany. His works include the famous *Das Heutige Englische Verfassungs und Verwaltungsrecht* (1867); *Verwaltung, Justiz, Rechtsweg* (1869); *Englische Self-Government* (1871); *Vier Fragen zur Deutschen Strafprozessordnung* (1875); *Gesetz und Budget* (1879); *Die Preussische Finanzreform* (1881); *Englische Verfassungsgeschichte* (1882). His writings deal chiefly with constitutional law in England and Germany, with politico-historical subjects, and with current questions of practical politics in Germany.

**GOAJIRA OR GOAGIRA,** a peninsula of South

America, the northernmost land of the continent. It was for a long time claimed by Venezuela, but in 1891 it was awarded to Colombia, since the former country held no actual jurisdiction over it. It consists mostly of low, flat lands. Its products are cattle, horses, hides, cheese and hammocks. Area, 5,800 square miles. Population, almost entirely uncivilized Indians, about 30,000.

GOAT ISLAND, an island 70 acres in area which divides the current of Niagara River just above its falls. It is 900 feet from the American shore, with which it is connected by a bridge.

GOAT-MOTH (*Cossus ligniperda*), a large moth common throughout Europe and Asia. It measures three inches across the wings, and has a thick, heavy body. The general color is yellowish gray, marked with irregular black lines. The caterpillar feeds on the leaves of willows and poplars, often destroying the trees. It lives three years before metamorphosis takes place.

GOAT'S-BEARD (*Tragopodon*), a genus of plants of the family *Compositæ*. The common goat's-beard (*T. pratensis*), also known by the name *Go-to-bed-at-noon*, is an erect biennial plant, an abundant native of Britain. The roots, if taken before the flower-stems shoot up, and boiled, resemble asparagus in flavor, and are said to be nutritious. Salsify, or oyster-plant (*T. porrifolium*), also a native of Britain, is cultivated in gardens for the sake of its esculent roots. In the United States the name is applied to *Spiræa Aruncus*, a rosaceous perennial herb of the North-eastern states, with compound leaves, lanceolate toothed leaves, and diœcious whitish flowers in a long compound panicle. *Astilbe decandra*, a species of *Saxifragacæ*, which somewhat resembles *Spiræa Aruncus*, is called false goat's beard.

GOAT'S-RUE, a name given in Europe to *Galega officinalis*, a plant of the family *Leguminosæ*, sometimes cultivated, like lucerne (especially in Switzerland), as a forage plant, on account of the great bulk of produce which it yields. Its peculiar smell is not relished by cattle unaccustomed to it. In America the name is given to *Tephrosia Virginiana*, another leguminous plant, otherwise known as hoary-pea and catgut. It is a silky herb, with simple leafy stems, leaves with numerous leaflets, and a terminal cluster of large yellowish-white and purple-dotted flowers.

GOBAT, SAMUEL, a Swiss bishop of the Protestant Church at Jerusalem; born at Cremine, Switzerland, in 1799; died at Jerusalem, May 12, 1879. In the Mission-house at Basel he prepared himself for the work of a missionary, from 1821 to 1824. After studying Arabic and Ethiopian in Paris he entered the service of the Church Missionary Society, and was sent to Abyssinia. But as that country was in a state of war, he stopped at Cairo for three years. In 1830 he was allowed to enter Abyssinia, and soon gained the good will of some of the prominent inhabitants. They gladly received from him an Amharic translation of the Gospels. On the renewal of the war in Abyssinia he returned to Europe. A second missionary journey, undertaken in 1835, was fruitless, on ac-

count of his severe illness. In 1839 Gobat became principal of the Missionary College at Malta, where he translated the Bible into several Oriental languages.

GOBBE OR VOANDZON (*Voandzeia subterranea*), a leguminous annual of tropical Africa whose young pod is thrust into the ground in the same manner as that of *Arachis hypogæa* (the peanut). The rich, oily seeds ("Angola peas") are wholesome and agreeable when boiled. The young pods also are used like French beans.

GOBELINS TAPESTRY. See TEXTILES, Vol. XXIII, pp. 212, 213.

GOBINEAU, JOSEF ARTHUR, COMTE DE, a French diplomatist and author; born at Bordeaux in 1816. His first diplomatic service was as secretary of the French legation at Bern, in 1851. He was next sent as ambassador to Persia in 1861, to Greece in 1864, to Brazil in 1869, to Sweden in 1872, and in 1877 he resigned and retired. Gobineau was much given to study wherever he found himself. Among his published works are *Essai sur l'Inégalité des Races Humaines* (1855), and *Histoire des Perses* (1869). Besides his literary pursuits he was also active in various philosophic and philanthropic endeavors. He died in Paris, Oct. 17, 1882.

GOD. See THEISM, Vol. XXIII, pp. 234-249.

GODARD, BENJAMIN LOUIS PAUL, a French composer; born at Paris, Aug. 18, 1849; entered the Conservatoire in 1863, studying harmony under Reber. He left the Conservatoire and became a viola-player, at the same time assiduously devoting himself to composition, producing much charming work. He orchestrated Schumann's *Kinderscenen*; produced a *Concerto Romantique* (1876); and in that year, bracketed with Theodore Dubois, carried off the prize at the musical competition of the municipality of Paris, his composition being entitled *Tasso*, which remains his greatest work. Among his other compositions are *Scènes Poétiques* (1879); *Diane*, a dramatic poem (1880); *Symphonie Orientale* (1883); *Les Éléphants* (1884). His more recent works include *Jocelyn*; *Les Guelfes*; and *Ruy Blas*. He died at Paris, Jan. 12, 1895.

GODDARD, ARABELLA, an English pianist; born at St. Servan, near St. Malo, in Brittany, Jan. 12, 1838; and received lessons from Kalkbrenner, Thalberg and Macfarren. She made her *début* at the grand national concerts in London in 1850, and in 1854-56, performed with great success as a classic player in the principal cities of France, Germany and Italy. In 1857-58 she played in London all the last sonatas of Beethoven, as well as many other masterpieces of Clementi, Dussek, Mozart, Mendelssohn and other composers. In 1860 she married J. W. Davison, a musical critic. She took her farewell of the British public in 1873, and then made a tour to Australia, the Sandwich Islands and the United States, returning to England in 1876.

GODERICH, a port of entry and chief town of the county of Huron, central western Ontario, Canada, situated on Lake Huron, at the termi-



nus of the Buffalo and Goderich division of the Grand Trunk railway, 78 miles N.W. of London. It has a good harbor, and communicates by steamer with the various lake ports. It has eight valuable salt-wells, extensive lake-fisheries and manufactories of woollens, machinery, boots and shoes, etc. Population 1891, 3,839.

GODET, FREDERIC LOUIS, a Swiss clergyman; born at Neuchâtel, Oct. 25, 1812; educated in his native town and at Bonn and Berlin; ordained a minister of the Reformed Swiss Church in 1836; was assistant pastor at Velangin, and became preceptor of the Crown Prince of Prussia in 1838; appointed professor of exegetical and critical theology in the theological school of the national church in 1850, and to the same position in the independent faculty of the church at Neuchâtel (1873). Among his noted works are *Histoire de la Réformation et du Refuge dans le Canton de Neuchâtel* (1859); *Commentaire sur l'Évangile de Saint Jean* (1863, 1865); *Commentaire sur l'Évangile de Luc* (1871); *Commentaire sur l'Épître aux Romains* (1879); *Commentaire sur la Première Épître aux Corinthiens* (1886); *Conférences Apologetiques* (1869); *Études Bibliques* (1873); etc. Many of these were translated into English and published in London and New York.

GODFREY OF BOUILLON. See CRUSADES, Vol. VI, p. 624.

GODFREY, THOMAS, an American inventor; born in Bristol, Pennsylvania, in 1704; died in Philadelphia, in December, 1749. He worked as a glazier, and studied mathematics, acquiring Latin in order that he might read mathematical works in that language. In 1730 he made an improvement in Davis's quadrant, which, after considerable delay, was laid before the Royal Society of London. A similar invention was, about the same time, presented by John Hadley, the vice-president of the society, and both claimants being declared entitled to the honor of invention, each received a prize of £200. The instrument is called Godfrey's or Hadley's quadrant, and is still in general use.

GODKIN, EDWIN LAWRENCE, an American journalist; born in Moyne, County Wicklow, Ireland, Oct. 2, 1831; graduated at Queen's College, Belfast, 1851. He was a correspondent of the London *Daily News* in Turkey and the Crimea in 1854-56, and then went to the United States as a correspondent of the same journal. He was admitted to the New York bar in 1859, and from 1862 to 1865 was correspondent of the London *Daily News* and an editorial



EDWIN L. GODKIN.

writer for the New York *Times*. In the latter year he became editor of *The Nation*, and in 1881, when it was made the weekly issue of the *Evening Post*, he became an editor and proprietor of

the joint publication. He wrote a *History of Hungary* (1856); *Government*, in the American Science Series (1871); *The Problems of Municipal Government* (1894); *Reflections and Comments* (1895); and *Some Unforeseen Tendencies of Democracy* (1897).

GODMAN, JOHN D., an American physician and author; born at Annapolis, Maryland, Dec. 30, 1794. He was a printer and a sailor, and fought at the bombardment of Fort Mchenry in 1814; next year commenced to study medicine, and in 1818 graduated in medicine at the University of Maryland, and practiced in Philadelphia. In 1821 he became professor of surgery in the Medical College of Ohio, and began the publication of the Cincinnati *Western Quarterly Review*. In 1822 he returned to Philadelphia, and two years later became an editor of the Philadelphia *Journal of Medical Sciences*. In 1826 he was made professor of anatomy and physiology in Rutgers Medical College, New Jersey, but resigned the following year on account of failing health. He wrote many articles for various periodicals, and published several works on natural history, anatomy and other subjects, being the author of *American Natural History* (1823-28). He also made a translation of Levasseur's *Account of Lafayette's Progress Through the United States*. He died at Germantown, Pennsylvania, April 17, 1830.

GÖDÖLLÖ, a market town of Hungary, 15 miles N.E. of Pesth, with a royal castle and park presented by the Hungarians, in 1867, to their king, the Emperor of Austria-Hungary. Here, April 7, 1849, the Austrian forces were defeated by the Hungarians. Population, 3,940.

GODON, SYLVANUS WILLIAM, an American naval officer; born at Philadelphia, June 18, 1809. He was appointed midshipman in 1819, promoted lieutenant in 1836, commander in 1855, and captain in 1861. He commanded the *Mohican* in the attack on Port Royal under Admiral Dupont; in 1863 was promoted commodore and commanded the fourth division of Admiral Porter's fleet (on the *Susquehanna*) at both bombardments of Fort Fisher, December, 1864, and January, 1865. At the close of the war he was made rear-admiral. He commanded the South Atlantic squadron in 1866-67, and was commandant of the Brooklyn navy-yard in 1868-70. In 1871 he was retired on account of age. He died at Blois, France, May 10, 1879.

GODOY, MANUEL DE, "Prince of the Peace." See ALUCUDIA, Vol. I, p. 471.

GOD'S TRUCE. See TRUCE OF GOD, Vol. XXIII, pp. 590, 591.

GODTHAAB. See GREENLAND, Vol. XI, p. 170.

GODWIN, PARKE, an American editor; born in New Jersey, Feb. 25, 1816; graduated at Princeton in 1834, and was admitted to the bar in Kentucky, but never practiced. From 1837 to 1853, excepting one year, he was connected with the New York *Evening Post*, assisting his father-in-law, William Cullen Bryant. In 1843 he issued the *Weekly Pathfinder*. He contributed largely to the *Democratic Review*, and was also an

editor of *Putnam's Monthly*. In 1865 he again became connected with the *Evening Post*. He wrote *Popular View of the Doctrines of Charles Fourier* (1844); *Construction Democracy; Vala: A Mythological Tale* (1851); *A Handbook of Universal Biography* (1851); *History of France* (1861); *Out of the Past* (1871); and an edition of Bryant's writings, with a complete biography (1883-84).

GOEBEL, JULIUS, a German philologist; born at Frankfort-on-the-Main, May 23, 1857; educated at the universities of Leipsic and Tübingen. He went to the United States and became instructor in German literature and philology at Johns Hopkins University (1888), and professor of Germanic literature and philology at Leland Stanford Junior University (1892). He edited *Belletristisches Journal*, New York City (1888-92); and wrote *Ueber die Zukunft Unseres Volkes in Amerika* (1883); *Ueber Tragische Schuld und Suchne* (1884); *Zur Deutschen Frage in Amerika* (1886); etc.

GOEBEN, AUGUST VON, a German soldier; born at Stade, Hanover, Dec. 10, 1816; entered the army in 1833, but desiring more active service, joined the Carlists in Spain, he was wounded and taken prisoner, and confined in jails in Cadiz and Saragossa. On his return to Germany he wrote an account of the Carlist war in *Four Years in Spain* (1841), and received a reappointment in the army, being on the staff of the Crown Prince, afterward Emperor William I, in 1849-55, in the latter year becoming chief of the staff of the Sixth Army Corps. For his success in the war against Denmark he was appointed, in 1864, lieutenant-general and commander of the Thirteenth Division. In the Franco-German war he commanded the Eighth Corps at Saarbruck and Metz; and also of the Army of the North, which was victorious over the French, under General Faidherbe, at St. Quintin, Jan. 19, 1871. Besides the work noted above, he wrote *Letters of Travel and Camp* (1863). He died at Coblenz, Nov. 13, 1880.

GOERTZ, GEORGE HEINRICH, BARON VON, a German political adventurer who became financial minister to Charles XII of Sweden (q. v., Vol. V, pp. 421, 422). He was born of a noble family of Holstein, and served many royal masters. On his return from imprisonment after his defeat at Pultowa, Charles, in passing through Stralsund, a city of what was then Swedish Pomerania, met Von Goertz. The baron succeeded in securing the entire confidence of the king, and was soon placed at the head of the Swedish finances, which were at a very low ebb, on account of Charles's military campaigns. Goertz propounded a scheme which met the approval of the King, the plan, for "re-establishing the currency," being to issue copper dalers instead of ingots, which dalers, bearing the king's stamp, were made legal tenders. As the coins were light, and therefore "well adapted for carrying in the pocket," the Baron thought they would circulate at their nominal value without any trouble. They were about the size of a modern American twenty-five cent piece, were stamped "1 daler silvermynt," and were overvalued nearly a hundred times. In no instance,

except by the government, were they accepted at their face value. There was no limit placed upon their coinage. The result was, that immediately the public found their sources of revenue excessively reduced, while the government was unable to sustain such a fiduciary issue, or compel the people to receive it at its fictitious value. This system, coupled with the previous issue of base silver coins, heavy copper plates and paper notes, to none of which were any limits prescribed, continued in force until the death of Charles, which occurred at the siege of Frederikshald, Dec. 11, 1718. The king's sister, Ulrica Elenora, ascended the throne and immediately promulgated a decree whereby the paper notes were wholly abolished, and the copper dalers reduced by successive steps. Charges were drawn up against Baron Goertz, and to appease the hatred of the public he was condemned to death, and beheaded at Stockholm, March 3, 1719. Baron Goertz is described as an "enthusiast," and as a "financier of the visionary kind." He received no personal benefit, however, from his wild scheme of finance.

GOES, JOANNES ANTONIDES VAN DER, a Dutch poet. See ANTONIDES, Vol. II, p. 138.

GOESSMANN, CHARLES ANTHONY, a German-American chemist; born in Naumberg, Germany, June 13, 1827. He was educated in the Fritzlar Gymnasium and at the University of Göttingen. After spending five years as assistant in the Göttingen chemical laboratories, he removed to the United States in 1857, and for the succeeding five years was connected with the New York salt industries. He was appointed professor of chemistry in Rensselaer Polytechnic Institute in 1862; in 1869, took a similar position in the Massachusetts Agricultural College. He contributed numerous articles on chemistry and allied subjects to scientific periodicals, principally to the *Annalen der Chemie und Pharmacie*.

GOETTLING, KARL WILHELM, a German philologist and historian; born at Jena, Jan. 19, 1793; died there, Jan. 20, 1869. He was educated at Jena and Berlin. In 1815, he became professor in the gymnasium at Rudolstadt; in 1819, director of the gymnasium at Neuwied; in 1822, professor extraordinary, and in 1832, professor in the University of Jena. He visited Italy, Sicily and Greece in connection with his archæological and historical studies. His works include *Das Geschichtliche im Nibelungenliede* (1814); *Nibelungen und Ghibellinen* (1817); *Geschichte der Römischen Staatsverfassung* (1840); *Gesammelte Abhandlungen aus dem Classischen Alterthum* (1851, 1863); etc.

GOFF, NATHAN, an American lawyer; born in Clarksburg, West Virginia, Oct. 9, 1843. Educated at the University of New York in 1861; entered the United States army, and in 1863 was appointed major of the Fourth Virginia Cavalry. He was made prisoner and confined in Libby prison; and afterward became brigadier-general of volunteers. He was admitted to the bar in 1865, and served a term in the West Virginia legislature; acted as district attorney from 1868 to 1881, and resigning the latter office to accept the Secre-

taryship of the Navy, vacated by Richard W. Thompson. Mr. Goff was a member of Congress, as a Republican, from 1884 to 1888. In the election for governor, in 1888, he was elected by a plurality of 106 votes, but, owing to the failure of the speaker to declare the result, the election was contested, the case went into the courts, and the Democratic candidate, A. Brooks Flemming, was eventually declared governor. In 1892 Mr. Goff was appointed judge of the circuit court of appeals.

GOFFE, WILLIAM, a British regicide; born in England about 1605; died in Hartford, Connecticut, in 1679. He was early trained to follow a business career, but entered the Parliamentary army, where, in 1665, he rose to be major-general. He was a member of Parliament in 1654, and again in 1656, and was one of the commission who condemned Charles I to death. When Charles II was called to return, Goffe, with Whalley, his father in law, set out for America. On July 27, 1660, they arrived at Boston, and settled at Cambridge. A reward was offered for their arrests, and the two retired from Cambridge to New Haven, where for a time they remained. In 1664 they removed to Hadley. They were several times seen during their stay at New Haven, but lived concealed from the pursuit of the crown officers. During King Philip's War the town of Hadley was bravely defended by the regicide Goffe, who, according to tradition, appeared mysteriously and repulsed a desperate onslaught of the Indians. It is believed Whalley died at Hadley in 1675. Goffe, in 1679, went to Hartford, where he shortly afterward died.

GOFFSTOWN, a manufacturing village of Hillsboro County, southern New Hampshire, on the Piscataquog River, and on the Boston and Maine railroad, 15 miles S. of Concord. It has lumber-mills and a machine-shop. The surrounding country produces hay, oats and dairy products chiefly. Population 1890, 1,981; 1900, 2,528.

GOGRA OR GHOGRA, a river of eastern India, which rises in the Himalaya Mountains, in lat.  $30^{\circ} 28' N.$ , long.  $80^{\circ} 12' E.$ , flows south and southeast, entering the Ganges in about lat.  $25^{\circ} 46' N.$ , long.  $84^{\circ} 40' E.$  It is navigable throughout the year. Length, 600 miles.

GOLCONDA, a village and the capital of Pope County, southern Illinois, on the Ohio River. Farming, mining and manufacturing are the chief occupations of the vicinity. There are several mills and a lead and a kaolin mine. Population 1890, 1,174; 1900, 1,140.

GOLD AND GOLD-MINING.—*Distribution.* The occurrence of native gold *in place*, and available for working, has, until recently, been thought to be chiefly confined to veins of quartz which intersect metamorphic rocks. These metamorphic rocks are mostly argillaceous, chloritic and talcose schists. Sometimes, but less commonly, the veins were found to intersect hornblende and mica schists, and even gneiss, diorite and porphyry, and, still more rarely, granite. Quartzite is also the native rock of many regions traversed by gold-bearing quartz veins. This

belief, that gold occurs more frequently in quartz veins than elsewhere, is correct; but within the past few years some very marked exceptions have been brought to light. The districts known as Gilpin and Clear Creek, named from their respective counties, in Colorado, show only quartz veins intersecting metamorphic rocks, known as *true fissures*; while at Aspen and Leadville, in the same state, both gold and silver are found in conjunction with lead sulphides and carbonates in limestone deposits; and at Cripple Creek the prevailing rock is a sort of gray, volcanic breccia, which is penetrated by dikes of more recent lavas, ascending through fissures. The ore-deposits occur chiefly in connection with the dikes, and are held to be later enrichments, through a process of leaching, or gathering by the aid of salts, which have a great solvent power as to gold.

Where the intersecting formations are numerous and diverse, the natural leaching-process is best facilitated, and the gold is slowly gathered from the surrounding rocks and precipitated in crystals and masses in conjunction with the dike fissures. This same leaching-process is also regarded as explanatory of the ore-deposits of quartz veins known as *true fissures*, as distinguished from dikes. The mineral of the Cripple Creek district is both native gold and in the form of gold tellurides, and the ores are of unusually high grade, the present output averaging nearly three ounces to the ton. Their high character is shown by the statement that the chief of the Australian milled ores average about 9 pennyweights per ton; the Californian, about 6 to 7; the Clear Creek and Gilpin, 6 to 8; the Homestake (Black Hills), 3 to 5; while the Witwatersrand mines, which made the Transvaal district of South Africa but lately the leading gold-producing country of the world, accomplish their wonderful results with conglomerates that average only 11 pennyweights to the ton.

*Production.* The output of Cripple Creek for 1895 was about \$8,000,000, and that of the Rand mines more than four times as great; while the total output for the world during 1895 was \$203,120,590, of which \$167,610,998 was produced by four countries, the United States coming first, with \$44,870,998; Africa coming second, with \$44,750,000; Australasia coming third, with \$44,000,000; Russia coming fourth, with \$33,990,000. India, China and Mexico produced about \$6,000,000 each, while the remaining \$17,000,000 was mined in comparatively small amounts in many countries throughout the world.

The increase of the world's output over that of 1894 was about \$24,000,000, and the increase in the United States was over \$5,000,000. It is predicted that Africa and the United States will soon exceed \$50,000,000 each in their production, and Australasia is not likely to be very far behind.

The mines of the Rand district, which are near Johannesburg, in the Transvaal country, are embraced within a strip of territory about three miles wide by seventeen long, and the remainder of

Africa, outside of this district, produced less than five million dollars in 1895.

There are important discoveries reported from Mashonaland and Matabeleland, and a large number of claims located, but the amount of their production is yet unimportant. The reasons given are their inaccessibility, and especially the difficulty of transporting machinery.

In the United States, the three states of California, Colorado and Montana produced about forty million dollars in 1895, which bears about the same ratio to the entire output that the Rand district does to the African. The remainder is divided between nine or ten Western states and territories, besides Georgia and the Carolinas.

*Mining.* In the mining of quartz and other rock ores, the facilities of to-day are better than those of a few years ago, owing rather to improvements in methods than to radical changes. Ore bodies are still drilled and blasted, and worked by pick and shovel, but mechanical improvements are doing much to revolutionize the industry. The use of compressed air, and especially of electricity, seems destined to bring about wonderful changes in the near future. There are now many mines which make use of electricity in one form or another, and at least one, at Silver Lake, Colorado, has recently been fully equipped with electric apparatus, the power for which is transmitted from the Animas River, three miles away. Not only the lighting, but the drilling, hoisting, pumping, crushing, and even the working of fans and air-compressors, are performed by electricity. Mines which are very damp interpose obstacles to the successful working of electrical apparatus, and, thus far, marked success has been experienced only where conditions are favorable. Experiments are also being made in the operation of amalgamating and gold-saving devices, and the first beginnings in electric ore-smelting are started. The latter have not yet advanced far enough to be called thoroughly successful.

*Extraction.* The ultimate problem of gold-extraction is the treatment of low-grade ores, and especially of low-grade sulphuret ores, which are more numerous by far than all others. While this problem cannot yet be said to have been entirely solved, such advance has been made as to justify the prediction of its triumphant outcome. Just now, the interest of a large part of the gold-mining world is centered upon two different methods of treating the low-grade sulphurets, both of which, in numerous instances, are very successful. One is known as the "chlorination" and the other the "cyanide" process. Chlorine gas and cyanide of potassium being ready solvents of gold, the principle is much alike in both processes, different kinds of apparatus, of course, being required.

One method of chlorinating, called the "Haycraft electrolytic process," is as follows: The ore is crushed and conveyed to an iron tub, beneath which a furnace keeps the contents at the boiling-point. Water containing a small percentage of

salt is mixed with the ore, and vertical revolving arms descend into the tub and keep the contents continually stirred. The arms are fitted with carbon shoes, forming the anode from which the current passes through the liquor to the bottom, where a pan of quicksilver forms the cathode. The current decomposes the salt, and the sodium passes to the mercury, the chlorine rising and absorbing the gold, which forms gold-chloride. The pulp continuing to circulate in the pan, the chloride of gold comes under the operation of electrolysis and is in turn decomposed. The chlorine, being liberated, seeks other gold, and the gold passes to the mercury and produces amalgam. In the end the contents are washed out of the tub, and the gold is freed from the amalgam by retorting. Chlorination of one sort or another has been used for a number of years, but the most marked success is recent. The great success, however, has been with simple sulphurets, like iron pyrites. As high as 98 per cent of the gold in concentrated sulphurets has been saved by chlorination, with a total cost, including mining, milling and chlorinating, of about \$2.50 per ton of ore mined. That, however, which chlorination has thus far failed of accomplishing is the treatment of complex sulphides, such as galena and zinc-blende. These must still be treated by smelting, and combinations with copper ores are necessary. In treating by cyanide, the method known as the "Siemens-Halske electric process of precipitation" is thus briefly described: After the ore has been crushed and collected into vats or tubs and subjected to solutions of cyanide of potassium, which dissolve the gold, the cyanides containing the gold are leached away into other tubs. A current is then introduced through an anode of iron plates, and the cathode is formed of broad, thin sheets of lead at the bottom. The electrolysis enables the lead to act upon and absorb the gold from the chlorides. After the operation has continued for a long time, the lead is collected and the gold separated by cupelling. The reasons for the choice of lead as a cathode are said to be four in number: (1) the precipitated gold will unite with it; (2) lead can be rolled into thin sheets; (3) it is an easy metal from which to recover gold; (4) it is not more electro-positive than the anode, and thus prevents return currents from being generated. At the Russell mine, in Montgomery, North Carolina, one hundred tons a day are treated by cyaniding, and 85 to 90 per cent of the gold saved, at a stated cost of 90 cents to \$1 per ton. The ores of almost the entire Rand district, in Africa, are treated by the Siemens-Halske process. For certain qualities of ore, cyaniding is regarded as more satisfactory, and at the same time cheaper, than chlorination. It is no better able to treat complex sulphurets, however, than the other method. The dissemination of gold throughout the world is so wide, that traces of it may be found in a larger part of the rocks and soils, in sea-water, and even in considerable quantity in coal strata. (See GOLD, Vol. X, pp. 740-753.)

*Placers.* In the history of mining, however, the greatest portion of the world's supply has been taken from placer-deposits. California has produced two billion dollars of gold, the larger part of which was from the sand and gravel beds of the Sacramento and other streams. In the palmiest days of mining the state produced fifty-five to sixty millions annually. The Australian yield has been nearly, although not quite, as great.

Siberia, Africa, Mexico, South America, British Columbia and a number of American states have been large producers of placer gold, but to-day there are no known deposits of such richness and extent as those which have been worked in the past, with the possible exception of the banks of the Upper Yukon, in Alaska, concerning which our information is meager and not very reliable.

In California the working of placer-deposits by the great hydraulic plants had become of so grave economic importance, through the altering of courses of streams, changing the entire topography of great tracts of country, and destruction of immense areas of grazing and arable land, that their operations have been restricted, and in many instances entirely suppressed, by legislative enactment. Similar, therefore, to the question of treating low-grade sulphurets in rock-mining, the great problem of importance in placer-mining which men's minds are now wrestling with is that of the rapid and economic handling of river sands, and the saving of the small percentage of fine gold which they contain.

The bars of the streams in the Rocky Mountain region, especially those of the Pacific Slope, are impregnated, some with finely powdered, others with light, flaky gold, so sparsely scattered as to be unprofitable to work by the older, cruder methods, but so extensively and uniformly distributed as to promise large returns for rapid and cheap handling.

Great sums of money have been expended upon devices and experiments of many sorts, but nearly all have been failures, while but moderate success has been attained by any. The requisite is a machine that will lift or dredge the sand from the river bottom (containing, perhaps, an average of 25 cents to 50 cents in gold to the cubic yard), pass it through amalgamators which will save all the light, fine gold, and do the work rapidly enough to render it profitable. There are now under construction great floating machines, combinations of dredge and elaborate amalgamating apparatus, which, it is claimed, are shortly to solve the problem. Whether or not the solution is so near at hand, it may be predicted with reasonable certainty that man's ingenuity and industry will accomplish the desired result in the end, and the production of gold increased in proportion to the world's growing demands.

*Mines.* Among some of the great gold properties of the present time are the Homestake, in the Black Hills; the Treadwell, in Alaska; Little Johnny, at Leadville, Bobtail and the Dunderberg, in Gilpin, Colorado; the Idaho, in Cali-

fornia; the Anna Lee, Delmonico, Portland, Buena Vista, Anaconda, at Cripple Creek; Mount Morgan, and Bailey and Ford, in Australia, and the Rand mines, in Africa. J. F. CARGILL.

*Cape Nome.* Gold-seekers, who have actively been at work at Dawson City and the Klondike region of the Canadian Yukon territory, are now greatly attracted by the rich auriferous deposits around Nome City, Alaska. The mushroom town is situated close to Cape Nome, which abuts into Bering Sea between Norton Sound and Bering Strait. It is reached directly by sea from Seattle, Wash., *via* the Aleutian Islands; or, by steamer up the coast to Dyea City, thence *via* Dawson City, B. C., Circle City, and down the Yukon river to St. Michaels, then across Norton Sound. In these regions of the far north the rigors of winter, when the thermometer falls to 45° below zero, are greatly dreaded; though to the lucky ones among the gold-seekers and those who are lured by the rich deposits of the precious metal, the compensations appear to be ample. There are indications that Nome City will be the metropolis of the Bering Sea, though as yet there is great scarcity of lumber for building purposes, the vegetation of the region being very limited and stunted. Everything edible has to be brought to the place, usually in steam whaling vessels, which begin to arrive at the port about the middle of June each year, at the close of the hibernating season. Latterly the price of lumber has fallen from \$500 a thousand feet to \$150, and even at that figure there is brisk competition. Already half a dozen rich mining districts have been discovered along the coast; while up the rivers there are many pay streaks of marvellous richness. Ophir creek, 100 miles up the Fish river, is one of the great strikes; the Koog Rok district, near Port Clarence, is another rich region. While much excitement exists over the finds on the beach at Top Kok, about sixty miles down the coast. G. M. A.

The following table shows the gold production in ounces of the United States and foreign countries for the year 1898:

United States (production in 1898).	3,118,398 oz., value, \$64,463,000
Transvaal, oz. (1898).	4,555,009
Rhodesia	21,581
India	415,147
New Zealand	280,176
British Guiana	113,000
West Australia	1,050,479
Queensland	618,109
Victoria	837,057
New South Wales	341,372
Tasmania	45,913

GOLDAU, formerly a small town of Switzerland, in the canton of Schwyz, memorable for its destruction by a stupendous landslide, Sept. 2, 1806. In a few minutes not only Goldau but the neighboring villages of Busingen, Röthen and Lowerz were overwhelmed, and a part of the Lake of Lowerz was filled up by the fall of the upper slope of the Rossberg. The valley is now a wild, rocky waste, overgrown with grass and moss. The village of New Goldau, on the line of the Rigi railway, consists of but a few houses.

GOLD COAST, a British crown colony on the

Gulf of Guinea, West Africa, with a coast line of 350 miles, bordered on either side by the Ivory Coast and the Slave Coast. It is enclosed on the east by Togoland (German), and on the west and north by the Ivory Coast and Senegal Territories (French). Its area, exclusive of Adansi and Ashantiland, is about 40,000 square miles, with an estimated population of one and a half millions, of whom only about 500 are Europeans. Its governor and commander-in-chief is Sir Frederic M. Hodgson, whose headquarters are at Accra, on the coast (pop. 16,267). The other chief towns are Elmina (pop. 10,530), and Cape Coast Castle (11,614). Its exports, besides valuable native woods, are palm oil, palm kernels, dye-stuffs, ivory, and India rubber. Gold is said to be now found and partly mined in the colony, and government railways and telegraph lines are under construction. A railway from Accra to the Volta river is contemplated, and surveys have been made for lines to Kumasi from Tarkwa (Tarquah) and Appam, while harbor works are being undertaken at Accra, the administrative centre. The affairs of the colony are managed by an Executive and a Legislative Council, both nominated. There are government elementary schools, but education is mainly in the hands of the various religious bodies. By the Colonial Loans Act of 1899, the sum of 578,000 pounds Stg. was advanced by the Imperial Government for the construction of railways from Secondee to the gold mines of Tarkwa, from the latter to Kumasi, and from Accra to the Volta.

Protracted correspondence between the English and French governments anent boundary questions have somewhat retarded settlement in the colony. The convention of 1898, however, practically settled the matter, the upper courses of the river Volta having been taken as the natural boundary line for the prolongation of the frontier between the Gold Coast and the French colony of the Ivory Coast. By the terms of the convention the French evacuated Wa and all points to the east of the river Volta, and south of the 11th parallel, but obtained the territory of Mossi, to the northward, thus closing the hinterland to the Gold Coast. France also obtained a slice of territory to the west of the river Volta, including the towns of Bona and Dawkita. More serious trouble has, however, recently arisen in the colony from the disaffection of the natives, due, it is said, in part, to French jealousies, and to the ambition of the dusky monarch of Ashanti, who having made submission to the English has since been exiled to Sierra Leone. Settlement in the colony has also been retarded by the want of roads and by an unhealthy climate. In the spring of 1900, a rising occurred of Ashantis around Kumasi, provoked, it is stated, by a fear of losing the symbol of their former ascendancy in the region. The small native and European garrison in Kumasi, in which the governor, Sir F. M. Hodgson, Lady Hodgson, and some European attendants, were at the time stationed, was attacked and had to undergo a lengthy siege. A relieving force of Hausas and Europeans from the coast, and a column of black regulars

from Nigeria, were dispatched to the aid of the garrison. Before either column reached Kumasi, Governor Hodgson and the bulk of the garrison were enabled (June 23) to break the siege and to set out for Cape Coast Castle, which they succeeded in reaching July 11, 1900. He brought Lady Hodgson away with him, together with most of the Europeans, including the missionaries; though a hundred native soldiers with two or three officers were left to defend the fort and await relief by Colonel Willcock's command. Almost all the food was left with the besieged. As we write, the country is still in a disturbed and unsettled condition, the menace by the Ashantis continuing, and the need being great for an adequate protecting force of European soldiery. G. M. A.

**GOLD CREST OR GOLDEN-CRESTED WREN**, a European bird of the genus *Regulus*, closely related to the warblers (a bright yellow mark on the head suggested the name). There are closely related species in the United States.

**GOLDEN**, a city and the capital of Jefferson County, northern central Colorado, on Clear Creek, and on the Union Pacific and the Denver and Rio Grande railroads, 15 miles west of Denver. It contains a college, state school of mines, flour and paper mills, smelting-works, foundry and coal-mines. It has good water-power from the creek, which runs several mills. Population 1900, 2,152.

**GOLDEN AGE**, a supposed state of pristine human excellence. (See ANTHROPOLOGY, Vol. II, p. 121.) The golden or patriarchal age of Hesiod was under the care of Saturn, and was the first or most remote of his five ages of human progress. The term is now used to refer to a culminating point in the history, but especially in the literature, of a nation, and is synonymous with the phrase *Augustan age*, referring to the period of about two hundred years ending with the reign of Augustus, Emperor of Rome, who died A. D. 14, during which time Rome was noted for its intellectual and literary attainments. The golden age of England was the reign of Elizabeth (1558-1603); that of France, during the reigns of Louis XIV and Louis XV (1640-1740); of Germany, the reign of Charles V (1519-58); of Prussia, the reign of Frederick the Great (1740-86); of Spain, the reign of Ferdinand and Isabella (1474-1516); of Sweden, from Gustavus Vasa to Gustavus Adolphus (1523-1632); of Russia, the reign of Peter the Great (1672-1725).

**GOLDEN BEETLE**, the name popularly given to many members of a genus of coleopterous insects, *Chrysomela* and of a subfamily, *Chrysomelidae*, belonging to the tetramerous section of the order. The body is generally short and convex, the antennæ simple and wide apart at the base. None of the species are of large size, but many are distinguished by their metallic splendor of color. The finest species are tropical. See COLEOPTERA, Vol. VI, p. 134; and INSECTS, Vol. XIII, pp. 149, 150.

**GOLDEN EAGLE**. See EAGLE, Vol. VII, p. 590.

**GOLDEN-EYED FLY**, a name usually given to neuropterous insects of the genus *Chrysopa*, related to the ant-lions. This insect is of a green color, with prominent gold-colored eyes. The odor is very disagreeable. These flies, especially in larval state, destroy great numbers of plant-lice, or aphides.

**GOLDEN FLEECE**. See ARGONAUTS, Vol. II, pp. 496, 497; MEDEA, Vol. XV, pp. 776, 777; and JASON, Vol. XIII, p. 596.

**GOLDEN FLEECE**, THE ORDER OF THE, an ancient and illustrious order of knighthood of Austria and Spain; was founded by Philip III, Duke of Burgundy, Jan. 10, 1429, at Bruges, on his marriage with Isabella, Infanta of Portugal. The order is consecrated to the Virgin Mary and the apostle St. Andrew. The badge is a golden ram pendant by a ring which passes round its middle. The badge hangs from an elaborately designed jewel, showing rich enameling of various colors, and with suggestive devices. The motto is, *Pretium laborum non vile*. In 1477 the office of grand master passed to the House of Hapsburg, with the acquisition of the Burgundian dominions, through the marriage of Mary, daughter of Charles the Bold (son of Philip III, founder of the order), to Maximilian I of Austria. After the time of Charles V (obit 1558), grandson of Maximilian I (who had become king of Spain as Charles I in 1516), the office of grand master was exercised by the Spanish monarchs. After the cession of the Spanish Netherlands to Austria, the latter power claimed the office. In consequence of the dispute, the order has existed independently in Austria and Spain. It is still the highest order bestowed in these countries.

**GOLDEN HORDE**. See MONGOLS, Vol. XVI, pp. 746-748.

**GOLDEN NUMBER**. See CALENDAR, Vol. IV, p. 670.

**GOLDENROD**, the common name of the numerous species of *Solidago*, one of the largest genera of the family *Compositæ*, especially represented in North America, where the goldenrods are among the most admired of late summer and autumn plants. They occur throughout the whole of North America, in all situations, but are chiefly represented in Europe by a single variable and perplexing species, *S. Virgaurea*.

**GOLD-EYE OR MOON-EYE**, fishes of the family *Hyodontidae*, common in the fresh waters of central North America. They resemble shad, are covered with bright shiny scales, and strong curved teeth are on the jaws, tongue and palate. Sometimes they are called toothed-herrings. They are of little value as food.

**GOLDFINNY, GOLDSINNY OR CORK-WING**. See WRASSE, Vol. XXIV, p. 686.

**GOLDMARK, KARL**, a Hungarian composer; born at Keszthely, on the Platten See, of Hebrew parents, May 18, 1830; was a pupil of Jansa, at Vienna; entered the Conservatorium in 1847. After the revolution of 1848, which interfered with his studies, he had good opportunities for improvement, and published some orchestral and

choral works. He next produced his overture, *Sacuntala*; in 1875, his grand opera, *Königin von Saba*; and later, *Die Ländliche Hochzeit*, a symphony. These gave him an international reputation. His three-act opera, *Merlin*, was produced at Vienna, Nov. 19, 1886. His recent works include *Das Heintchen am Herde* ("The Cricket on the Hearth"); and *The Prisoner of War*, an opera (1898).

**GOLD-OF-PLEASURE OR FALSE-FLAX**, the *Camelina sativa*, an annual plant of the family *Crucifera*, growing in Europe, and sparingly in the United States. Its fibers can be used for the manufacture of coarse fabrics, and it is sometimes cultivated for the oil of its seeds.

**GOLDSBORO**, a city, the capital of Wayne Co., N. C., on the Little River (navigable), 53 miles S. E. of Raleigh; is a railroad center on the great Southern thoroughfare of travel, has a college for women, and ships much cotton, to the cultivation of which the neighborhood is devoted. Pop. 1900, 5,877.

**GOLDSBOROUGH, LOUIS MALESHERBES**, an American naval officer; born in Washington, District of Columbia, Feb.

18, 1805; entered the navy as midshipman at seven years of age, and at twenty was appointed lieutenant. In 1827 he received the thanks of the English government for the rescue of the brig *Comet*, which had been captured by Greek pirates. During the Seminole war he commanded a company of volunteer cavalry, and in 1847 was executive officer of the frigate *Ohio*, which bombarded Vera Cruz. In 1849 he was senior member of the commission to explore California and Oregon, and in 1853-57 was superintendent of the United States Naval Academy. In 1861 he became flag-officer, and was placed in command of the *Minnesota*. He was made rear-admiral in 1862, and in 1865 commanded the European squadron. In 1873 he was placed on the retired list, after a longer service and more active duty than any other naval officer then living. He died at Washington, District of Columbia, Feb. 20, 1878.



ADMIRAL GOLDSBOROUGH.

**GOLDSCHMIDT, JENNY MARIA LIND, MADAME**, "The Swedish Nightingale"; born in Stockholm, Oct. 6, 1820. Her father was a teacher of languages. When only three years old, she could sing any piece she had ever heard. At nine she was admitted to the singing-school attached to the court theater. Soon afterward she played juvenile parts on the stage, showing considerable dramatic ability. At eighteen she appeared in the rôle of Agatha in *Der Freischütz*, Alice in *Robert le Diable*, etc., and soon became the prima donna of the Royal Theater, Stockholm. In 1841 she went to Paris to receive lessons from Garcia, who did not encourage her at first. But Meyerbeer, who heard her once, prophesied a brilliant future for the young singer. Her voice was thought to

be wanting in volume, and when she appeared at the Grand Opera two years later, her failure was so discouraging that she resolved never again to sing in France.

In 1844 she went to Berlin, where she studied German. Returning to her native city, she was



JENNY LIND.

heard with enthusiasm in *Robert le Diable*. Upon Meyerbeer's recommendation she was engaged at Berlin in October, appearing in *Norma* and in Meyerbeer's operas. In 1846 she visited Vienna; in 1847, London. Prices at Her Majesty's Theatre rose to a fabulous height, and "the town," says Chorley, "sacred and profane, went mad about the Swedish nightingale." She selected the part of Alice, which had first shown the sweetness of her voice. Her soprano voice was at that time very thrilling and sympathetic. On May 18, 1849, she sang on the London stage for the last time, in *Roberto*. After that her appearances were confined to the concert halls.

In September, 1850, she came to America under the auspices of P. T. Barnum. Her share of the profits of a brilliant tour in this country, amounting to \$100,000, she afterward spent in founding and endowing musical scholarships and charities in Sweden and England. Her first concert in New York was accompanied by scenes of the wildest enthusiasm. The seats were sold at auction, and hundreds of dollars bid for the best choice. After giving about one hundred concerts in the principal American cities, she married, at Boston, Massachusetts, Feb. 5, 1852, OTTO GOLDSCHMIDT (a pianist, conductor and composer of several oratorios; born at Hamburg, Aug. 21, 1829; died in 1890), who had accompanied her as pianist, and succeeded Mr. Benedict as conductor. Returning to Europe, she continued to sing at concerts and oratorios, as in London (1856), and for the last time at Düsseldorf in 1870. Her English charities included the gift of a hospital to Liverpool, and of a wing of another to London. Her voice retained its sweetness to the last, but she sang only occasionally, either in London drawing-rooms or at the Royal College of Music, where she was professor of singing from 1883 to 1886. Jenny Lind's mind was pure and elevated, and her feelings deeply religious. She died near Malvern, England, Nov. 2, 1887. Of her Moscheles writes: "What shall I say of Jenny Lind? I can find no words adequate to give you any real idea of the impression she has made. . . . So much modesty and so much greatness united are seldom, if ever, to be met with; and although her intimate friend Mendelssohn had given me an insight into the noble qualities of her character, I was surprised to find them so apparent."

GOLDSCHMIDT, MEYER AARON, a Danish

novelist; born at Vordingborg, Zealand, Oct. 26, 1819; studied at the University of Copenhagen; in 1840, started *The Corsair*, a weekly journal, which was brilliantly edited; and in 1848 founded *The North and South*, a critical journal. He became more appreciated for his novels, in which he blended a sparkling wit with a sympathetic pathos, the delicacy of his style being equaled only by the sensitive idealism of his nature. Among the best known of his works are *A Jew* (1852); *The Homeless Man* (1853); *The Heir* (1865); and *The Raven* (1867). He died Aug. 16, 1887. See also DENMARK, Vol. VII, p. 93.

GOLD STICK, a title given in England to the captain of the Gentlemen-at-Arms, and to the colonel of the Second Regiment of Life Guards, who bear gilded rods on occasions of state.

GOLDTHREAD, the popular name in America for *Coptis trifolia*, a ranunculaceous plant, found from Denmark to Siberia, and over the North American continent, through Canada, into the United States. It is a small, creeping plant, the leaves somewhat like those of the strawberry, but smaller, and evergreen under the snow. The flowers are small and white. The name *goldthread* is given on account of its long, bright-yellow and bitter fibrous roots. It was a popular remedy with the Indians of the northern United States and Canada for sore mouths and ulcerated throats. The French Canadians use it often for these maladies, little bundles of the roots being often sold in the French markets of Montreal, under the name of *Tissa voyanne jaune*. The Indians made a dye from the stems and leaves, by which they colored skins of animals a saffron yellow.

GOLDTHWAITE, a village and the capital of Mills County, central Texas, on the Gulf, Colorado and Santa Fé railroad, 100 miles N.W. of Austin. It is the shipping-point for cotton, live-stock and grain raised in the vicinity. Population 1890, 1,066; 1900, 1,287.

GOLFO DULCE, a town and a lake; also called IZABEL. See GUATEMALA, Vol. XI, pp. 239, 241.

GOLIAD, a village and the capital of Goliad County, southern Texas, situated on the north bank of the San Antonio River, about 90 miles S.E. of the city of San Antonio. It is the seat of Aranama College. It has a salubrious climate, and is surrounded by rich lands. In March, 1836, the village was garrisoned by Texans, 500 of whom were massacred on its capture by Santa Anna's Mexican soldiery. Population, 1,300.

GOLIARDIC POETRY. See RENAISSANCE, Vol. XX, p. 383.

GOLIATH-BEETLE, a popular name given to the immense coleopters of the genus *Goliathus*, of the family *Scarabæidae*, living in western Africa. Many of these beetles are brilliantly colored. *G. giganteus*, one of the largest known beetles, is four inches long and two inches broad. Their food consists of the sap of trees. The name is often applied to related genera, which attain a large size.

GOLOMYNKA (*Comephorus baikalensis*), a re-



markable fish, found only in Lake Baikal. It is about a foot long, is destitute of scales, and is very soft, its whole substance abounding in oil, which is obtained by pressure. It is never eaten.

**GOMARA, FRANCISCO LOPEZ DE**, a Spanish historian; born at Seville in 1510; educated at the University of Alcalá, and abandoned the career of arms, intended for him, for a literary one; became a priest; and in 1540 became secretary and chaplain to Hernando Cortes, who was then in Spain. Cortes did not again visit America, but, with Gomara, joined in the campaign of Charles V in Algeria. Gomara wrote a *Historia General de las Indias* (1552-53), a model of concise elegance, which was translated into several languages. The second part, devoted to Mexico, was subsequently published separately, with a new title, *Corónica de la Nueva España con la Conquista de Méjico*. Died about 1560.

**GOMARISTS OR CONTRA-REMONSTRANTS.** See GOMARUS, Vol. X, p. 769.

**GOMBROON.** See BENDER-ABBASI, Vol. III.

**GOMERA.** See CANARY ISLANDS, Vol. IV, 800.

**GOMEZ Y BAEZ, MÁXIMO**, the leader of the Cuban revolt; born at Bani, Santo Domingo, Aug. 25, 1826. Here was his home, where his wife and children lived, and where he owned a small farm, the wife and daughters earning their living as music-teachers and seamstresses. Gomez has a son holding a clerkship, whom the father has managed to keep out of the war. Of himself he says: "I was born, educated, and have spent the greater



MÁXIMO GOMEZ.

part of my existence on the field of battle." He served in the Spanish army as a major, in the reserves, but renounced that rank when the standard of revolt was raised, and became the organizer and commander of the Cuban insurgents, being induced by José Martí early in 1895 to join the revolt.

Previously, Gomez had served in the Ten Years' War (1868-78) on the insurgent side, and commanded one of the departments into which Cuba was divided on the death of General Agramonte. He fought also at Las Guasimas, where many Spanish soldiers were cut down by machetes. In 1895-96 he, with Antonio Maceo, marched into the western provinces, where the Spanish had 50,000 troops, and there, on crossing the trocha or dead line, they pillaged and burned right and left, devastating the whole country, and destroying sugar-mills, plantations, and towns. On Feb. 18 (1896) Jaruco was given to the flames, and its fort was captured, with 80 guns. The destruction, which seemed wanton, was inspired by a conviction in the mind of Gomez that it was Cuba's wealth that caused the bondage of Cubans, and hence he determined to make the island a desolation, especially to the Spanish. In many respects Gomez was hardly less cruel than Weyler when the latter gave effect to his concentration policy, which was

practically a policy of extermination. Nor did Gomez look with favor on intervention by the United States, since the success of Cuban arms, as he himself said, depended on the unity and coöperation of the rebel forces. Perhaps for this reason little aid was forthcoming from the insurgents when the United States took the field against Spain, destroyed her fleets, took Santiago, and compelled her to cede and evacuate Cuba.

**GOMPERS, SAMUEL**, an American labor leader; born in London in 1854. His education was received at night-school, while

he worked by day, first as a shoemaker and then as a cigar-maker. At the age of 13 he arrived in the United States, and became a member of the International Cigar-Makers' Union. He was sent as a delegate to the early conventions of the American Federation of Labor, where he developed abilities as a



SAMUEL GOMPERS.

leader, and was elected to various offices, and lastly to the presidency. He held the office for several years, was defeated for reelection in 1894, but was reelected the following year. He edited *The American Federationist*, a monthly periodical started in March, 1894, to which the leading writers on labor subjects contributed. Mr. Gompers believed in "high dues, thorough organization, perfect discipline, sick-benefits, out-of-work benefits, traveling-benefits, and in maintaining an aggressive position at all times for higher wages and shorter hours." In 1894 he was committed to free silver, a position from which he receded in 1896. He also believed in the principle of the income tax, on a graduated scale, for all self-supporting men.

**GOMPERZ, THEODOR**, an Austrian philologist; born at Brünn, March 29, 1832; educated at Vienna, and studied at Venice, Naples, Paris, London, and Oxford; became extraordinary-professor of philology at Vienna in 1869; and ordinary-professor in 1873. He was noted for his work in connection with the papyri found at Herculaneum, and published *Philodemi Epicurei de Irá* (1864); *Philodemus de Musica* (1885); and *Herculianische Studien* (1886). Besides other contributions to the elucidation of classic texts, he assisted in the translation of the complete works of John Stuart Mill (1869-80).

**GOMUTI PALM**, the *Arenga saccharifera*, a very useful palm of the East Indies, yielding an abundant palm wine, from which sugar is obtained, and also *arrack* (by distillation).

**GONAIVES**, a seaport of Haiti, in lat. 19° 26' N., long. 72° 43' W., on a beautiful bay on the west coast, with an excellent harbor, 65 miles N.N.W. of Port-au-Prince. It exports coffee, cotton, log-wood, and hides. Population 1887, 18,000.

**GONÇALVES DIAS, ANTONIO**, a Brazilian poet; born at Caxias, Maranhão, Aug. 10, 1823; was educated in law at Coimbra, Portugal; began to be attracted to literature, however, and wrote poems for

the Portuguese journals. On his return to Brazil, he accepted a position as professor of history at the Pedro II College, Rio de Janeiro; and in 1846 published *Primeiros Cantos*, which was followed by a second volume of poems in 1848, and *Ultimos Cantos* in 1851. From 1850 to 1858 he studied the scientific schools in Germany and France, and returned to Brazil to become ethnographer and historian of a government expedition to the province of Ceará, in connection with which he published ethnographical and historical papers, and a dictionary of the Tupy language. His latter years were spent in Europe. He met his death by shipwreck, Nov. 3, 1864, while returning to Brazil. The first four cantos of his epic, *Os Tymbiras*, appeared at Leipsic in 1857, and an edition of his works was published in 1860.

GONCOURT BROTHERS, DE, two French literary and artistic collaborators. The elder, EDMOND LOUIS ANTOINE HUOT DE, was born at Nancy, May 26, 1822, and died in Champrosay, in Seine-et-Oise, July 16, 1896; the younger, JULES ALFRED HUOT DE, was born in Paris, Dec. 17, 1830, and died at Auteuil, June 20, 1870. They started their career with a novel, *En 18 . . .* (1851), published conjointly. This was followed by *Salon de 1852*. They then commenced a series of studies on the society and art of the eighteenth century in France. A list of their works from this time includes: *Histoire de la Société Française pendant la Révolution et sous le Directoire* (1854); *Portraits Intimes du XVIII<sup>e</sup> Siècle* (1856); *Histoire de Marie Antoinette* (1858); *Les Maîtresses de Louis XV* and *Les Hommes des Lettres* (1860); *La Femme au XVIII<sup>e</sup> Siècle* (1862); *Germine Lacerteux* (1865); *Idées et Sensations* (1866); *Manette Salomon* (1867); *Madame Gervaisais* (1869). After the death of the younger brother, Edmond de Goncourt published, under his own name: *L'Œuvre de Prud'hon* (1877); *Les Frères Zemganno* (1879); *Chéric* (1884); *Madame Saint-Huberti* (1885); *Mlle. Clairon* (1890). The *Journal des Goncourt*, *Mémoires de la Vie Littéraire*, 1851-70 (1887-88); *Second Series* (1890), is one of the most remarkable of contemporary records. It is an interesting repository of criticism. The brothers' novels were intensely and uncompromisingly realistic, the Goncourts being regarded as the founders of the French realistic school. The bulk of Edmond de Goncourt's fortune, by the terms of his will, was to be applied to founding an Académie des Goncourt, the membership to consist of ten men named in the testament.

GONDOLA. See VENICE, Vol. XXIV, p. 157.

GONDS. See GONDWANA, Vol. X, p. 770.

GONIATITES, a genus of fossil cephalopodous mollusks of the family of ammonites. They are distinguished by the septa, which are lobed, but not serrated, hence the suture is a continuous, undulating line. Numerous species have been recognized, all from Palæozoic strata.

GONIDIUM, a name applied to asexually formed spores produced by the gametophyte of lower plants, serving the purpose of rapid multiplication. The name was formerly applied to the algæ living in symbiotic relations with the lichen-fungus.

GONOCOCCUS. See SURGERY, AMERICAN, in these Supplements.

GONORRHEA. See SURGERY, AMERICAN, in these Supplements.

GONZALES, a city and the capital of Gonzales County, southeastern central Texas, on the Guadalupe River and on the San Antonio and Aransas Pass and the Southern Pacific railroads. It is one of the oldest towns of the state. The inhabitants are mainly engaged in shipping agricultural products, especially cotton and stock raised in the vicinity. It is the seat of Guadalupe College. Population 1890, 1,641; 1900, 4,297.

GONZALEZ, MANUEL, a Mexican soldier; born near Matamoras, Mexico, in Oct., 1820; became a guerrilla leader in 1853, and was prominent in the reactionary party. In 1861-65 he assisted Juarez against the French and imperialists and in 1876, joined with Diaz to overthrow Lerdo de Tejada. In 1878 he became Secretary of War under Diaz, whom, in November, 1880, he succeeded as President, resigning in 1884. He was afterward governor of the state of Guanajuato. He died in Mexico, May 8, 1893.

GONZÁLEZ Y DÍAS-TUÑÓN, ZEFERINO, a Spanish cardinal; born at Vitoria, the capital of the province of Alava, Jan. 28, 1831; entered the Dominican order; went to the Philippines and taught theology and philosophy; returned to Spain in 1867, and was named bishop of Malaga in 1874; was promoted to the archbishopric of Cordova in 1875; and transferred to the see of Seville in 1883. He was elevated to the dignity of cardinal priest, Nov. 10, 1884; and next year was appointed archbishop of Toledo and primate of Spain, but retired from the see the year following, on account of ill health. The Cardinal published several works, including a study of the philosophy of St. Thomas (1864); a work on elementary philosophy, adopted in the higher seminaries and schools of Spain and a history of philosophy, a second edition of which appeared in 1883. He died at Seville, Nov. 29, 1894.

GOOBER. See GROUND-NUT, Vol. XI, p. 221.

GOOCH, FRANK AUSTIN, an American chemist; born in Watertown, Massachusetts, May 2, 1852; graduated at Harvard in 1872, and became attached to the chemical laboratory there. He served with the United States Geological Survey, and in 1886 was appointed professor of chemistry at Yale. He was a member of many scientific societies, wrote on improved methods of analysis, and devised the "Gooch filter," much used in chemical laboratories.

GOODALE, DORA READ, an American writer; born at Mount Washington, Berkshire County, Massachusetts, Oct. 29, 1866. She exhibited great precocity, and at an early age, with her sister Elaine, began to write verses, a selection of which appeared in *St. Nicholas*, December, 1877; and both sisters afterward published several volumes conjointly (see EASTMAN, ELAINE, in these Supplements). Dora afterward devoted herself to the study of art.

GOODALE, GEORGE LINCOLN, an American

botanist; born in Saco, Maine, Aug. 3, 1839; graduated at Amherst, and in medicine at Harvard and Bowdoin in 1863. He became professor of botany at Harvard and director of the botanical garden, and was elected a member of the council of Harvard College library and of the faculty of the museum of comparative anatomy. Dr. Goodale published *Wild Flowers of North America* (1882); *Vegetable Physiology* (1885); *Vegetable Histology* (1885); the last two expanded into *Physiological Botany* (1885); and *Useful Plants of the Future* (1891).

GOODALL, FREDERICK, a British artist; born in London, England, in 1820; became A.R.A. in 1852, and R.A. in 1863. He is best known by his historical paintings and works of genre. He won the Isis medal of the Society of Arts for a drawing of *Lambeth Palace*, and also a silver medal from the same society for *The Finding of the Dead Body of a Miner by Torchlight*, his first attempt in oil. Among his more noted works are *The Village Festival*; *The Summer Song*; *The Song of the Nubian Slave*; *A Bedouin Mother and Child*; *Rachel and Her Flock*; *An Intruder in the Bedouin's Camp*; *Palm Sunday*; *Glencoe*; and *The Time of Roses*.

GOODE, GEORGE BROWN, an American ichthyologist; born in New Albany, Indiana, Feb. 13, 1851. He graduated at Wesleyan University in 1870, and in 1871 became an assistant in the natural history museum at that institution. His work there resulted in a call to the Smithsonian Institution in 1873, where, from 1874 to 1887, he was chief of the division of fisheries. In 1887 he was appointed United States Fish Commissioner, but resigned the following year to become assistant secretary of the Smithsonian Institution and director of the National Museum. His knowledge of museum administration, together with his rank as an ichthyologist and general scientist, placed him among the foremost of American scholars. He was director of the Natural History Division at the Centennial Exhibition of 1876; United States commissioner to the international fisheries exhibitions at Berlin (1880) and at London (1883); represented the Smithsonian Institution at the expositions in New Orleans, Cincinnati and Louisville in 1884, Chicago in 1893, and Atlanta in 1895. He wrote numerous papers on ichthyology and allied subjects. Among his publications are *Game-Fishes of the United States* (1879); *American Fisheries* (1880); *Natural History of the Bermudas* (1882); *American Fishes* (1887); and *Oceanic Ichthyology* (1894). He died in Washington, District of Columbia, Sept. 6, 1896.

GOODELL, WILLIAM, an American missionary; born at Templeton, Massachusetts, Feb. 14, 1792; graduated at Andover Theological Seminary in 1820; and two years later sailed for the island of Malta. In 1823 he went to Beirut, and in 1831 to Constantinople. He endured many hardships, and during his 29 years of missionary life was compelled to change his residence 33 times. He returned to the United States in 1865. In 1843 he completed a translation of the Scriptures from

the original Greek and Hebrew into Armeno-Turkish, and later contributed papers to the *New York Observer*, entitled *Reminiscences of the Missionary's Early Life*. He died in Philadelphia, Feb. 18, 1867.—His son, WILLIAM GOODELL, an American physician, was born on the island of Malta, Oct. 17, 1829; graduated in medicine at Williams College in 1851, and at Jefferson Medical College in 1854. He first practiced at Constantinople, afterward at West Chester, Pa., and in 1865 was appointed physician of the Preston Retreat, in Philadelphia. In 1874 he was elected professor of gynæcology in the University of Pennsylvania, and president of the Obstetrical Society of Philadelphia. He published *Lessons in Gynæcology* (1886). Died in Philadelphia, Oct. 27, 1894.

GOOD HOPE, CAPE OF, a high rocky promontory, extending from the southwestern coast of Africa. Its height is about one thousand feet above sea-level, and it extends out for thirty miles south of Cape Town. On the point is situated a lighthouse, at lat. 34° 22' S., long. 18° 30' E. To the east is False Bay. The cape was first discovered in 1486 by Bartholomew Diaz.

GOODRICH, CHARLES AUGUSTUS, an American clergyman and author; born at Ridgefield, Connecticut, in 1790; graduated at Yale in 1812; studied theology, and was pastor in the First Congregational Church, in Worcester, Massachusetts (1816-20); in Berlin (1820-48); and afterward in Hartford, Connecticut. He published, among other works, *Lives of the Signers* (1829); *History of the United States of America* (revised edition, 1867); *Geography of the Chief Places Mentioned in the Bible* (1855); *Child's History of the United States* (1855); *Great Events of American History*; etc. He died at Hartford, Connecticut, Jan. 4, 1862.

GOODRICH, CHAUNCEY ALLEN, an American lexicographer; born in New Haven, Connecticut, Oct. 23, 1790; died there, Feb. 25, 1860. He was graduated at Yale in 1810; was a tutor there from 1812 to 1814; pastor of the Middletown (Connecticut) Congregational Church in 1816-17; professor of rhetoric and oratory in Yale from 1817 to 1839; and professor of pastoral theology until his death. He contributed extensively to various periodicals, and in 1829 established the *Christian Quarterly Spectator*, being its sole editor from 1836 to 1839. Besides some educational works, he edited *Webster's Unabridged Dictionary* and *Select British Eloquence*.

GOOD ROADS MOVEMENT. See LEAGUE OF AMERICAN WHEELMEN, in these Supplements.

GOODS AND CHATTELS, a term used in legal documents to designate all personal property, whether in possession or merely existing through right of action. Choses in action, leaseholds and implements are included within the general term *goods and chattels*. If used without limitation in a will, these words will pass all personal property, of every kind or nature. In criminal law, however, the term has not this broad application, and such articles as mortgages, notes, money and other choses in action do not

usually come within the meaning of this general term. If such property is described in an indictment as goods and chattels, it will not be sufficient.

GOOD TEMPLARS, INDEPENDENT ORDER OF, a total abstinence society founded in New York City in 1851, and extended to Great Britain in 1868, where the grand lodge was organized by Joseph Nalin in 1870. Since then the order has spread over the whole of the United States, Canada, England, Scotland, Ireland, Wales, Germany, Denmark, Sweden and Norway, the West Indies, East, West and South Africa, Australia, New Zealand, British India, Iceland, etc. All persons who become members have to subscribe to the pledge that they will never make, buy, sell, use, furnish, nor cause to be furnished, to others, as a beverage, any spirituous or malt liquors, wine or cider, and will discountenance the manufacture and sale thereof in all proper ways. The order seeks to protect the abstinent and to reclaim the inebriate. Both sexes are admitted to equal privileges and office. The order consists of local or subordinate lodges, which meet weekly; county or district lodges, which meet quarterly; grand or national lodges, which meet annually; and an international supreme lodge, which meets biennially, in different countries. In 1876, when the international lodge met in Kentucky, a disruption occurred over the negro question, there then arising two branches, one mainly British, the other mainly American. The two branches were reunited at the double meeting held at Saratoga, May, 1887, no one being excluded on account of color or race. The order publishes about forty newspapers and magazines, in different languages. The international lodge has met in the United States, Canada, in the four divisions of the United Kingdom, in Sweden, and in 1897 in Zurich, Switzerland. The united international supreme lodge had, in 1896, a membership of 403,849, distributed throughout its one hundred local lodges. There is a juvenile order, enjoining abstinence from strong drink, tobacco, profanity and gambling.

GOOD WILL, in the legal application of the term, the benefit or advantage which attaches to a particular trade, profession or occupation, in addition to the mere value of the property used to carry on such business, by reason of the public patronage which is given to such business from regular customers or patrons who have been accustomed to deal there because of the convenience of the location or skill and reputation of the proprietor. Many other elements may exist, through accident, necessity or ancient partiality, to increase the value of the good will of a business, especially if it be a business of long standing. It may be described as the probability that the old customers will trade at their accustomed place. The good will of a business may be sold, the same as other personal property, and if a trade or business be sold together with the good will, the old proprietor may generally start a similar business in the same locality, but not an identical business,

and he must not solicit the old customers to leave the business thus sold. He may, however, stipulate that he will not engage in a similar business in the same locality for a certain period of time, and such agreement will be enforceable.

GOODWIN, DANIEL RAYNES, an American educator; born at North Berwick, Maine, April 12, 1811; graduated at Bowdoin in 1832; studied at Andover Theological Seminary one year, leaving to accept a tutorship at Bowdoin, where, after two years' travel in Europe, he was professor of languages from 1835 to 1853. In 1853 he became president of Trinity College, Hartford, where he was also professor of Christian ethics; in 1860 he became provost of the University of Pennsylvania, where he also taught intellectual and moral philosophy. In 1862 he filled the chair of apologetics, exchanging this in 1865 for that of systematic divinity. In 1868 he resigned his office with the university to become dean of the divinity school; and in 1884 again became professor. He was regularly a delegate to the general conventions of the church and one of its directing spirits. He was the author of *The New Realistic Divinity, neither the Religion of the Bible and Prayer-book, nor of the Holy Catholic Church* (1879); *Notes on the Revision of the New Testament Version* (1883); and *Christian Eschatology* (1885). He died at Philadelphia, March 15, 1890.

GOODWIN, NAT. C., an American comedy actor; born in Boston, Massachusetts, in 1857; studied under Wyzeman Marshall, a Boston actor and manager. Edward E. Rice, to get rid of his importunities, gave him a chance, in 1874, to make his first appearance on any stage, as the fore legs of the heifer in his burlesque of *Evangeline*, in which he made a hit—such as it was. In 1876 he appeared in *Law in New York*, wherein he succeeded, probably more by his imitations of well-known actors than by a higher histrionic talent. At Haverly's Theater he subsequently appeared for 150 nights as Captain Crosstree, in the burlesque of *Black-eyed Susan*. By this time he had become pretty well known, and he had a play named *Hobbies* written for him by a Boston playwright, Benjamin E. Woolf, in which he made quite a success, in conjunction with Eliza and Jennie Weathersby. After playing in that for two seasons, he appeared in *The Member for Slocum*, *The Black Flag*, and other plays. His success in recent years in *Lend Me Five Shillings* and some modern light comedies has been pronounced. One of the most artistic triumphs of his later career was in Augustus Thomas's play of *In Miz-zoura*, wherein his rôle was that of a typical Missouri sheriff, making a study and presentation of character, which shows that he possesses much of the creative art necessary to make a permanent comedy success. He acquired even greater prestige in *David Garrick*, in which impersonation he demonstrated his ability to accomplish the highest achievements of his art.

GOODWIN, WILLIAM WATSON, an American scholar; born at Concord, Massachusetts, May 9, 1831; graduated at Harvard in 1851; and studied

in German universities, taking his doctor's degree at Göttingen in 1855. He was a tutor at Harvard from 1856 to 1860, when he became professor of Greek literature. He was a member of several scientific and historical societies, and has contributed to various literary and philological journals. He published *A Greek Grammar*, and *Syntax of the Moods and Tenses of the Greek Verb*, which has gone through many editions, etc.

GOODYEAR, CHARLES, an American inventor; born at New Haven, Connecticut, Dec. 29, 1800; died in New York City, July 1, 1860. At the age of 21 he became a member of the firm of A. Goodyear and Sons, manufacturers of steel hay-forks, but in 1830, through the failure of Southern houses, the firm was compelled to suspend. From that time until his death Mr. Goodyear was engaged in experimenting with India rubber. In 1836 he discovered that the action of nitric acid on rubber produced a curing effect; but this was superseded by the use of sulphur, and in 1844 he obtained his patent for vulcanized rubber, and lived to see his material applied to nearly 500 uses, and to give employment to more than 60,000 persons. He received medals from the exhibition at London in 1851, and from the Paris exposition of 1855, and the cross of the Legion of Honor from Napoleon III.

GOOKIN, DANIEL, an American colonial soldier; born in Kent, England, about 1612. He removed to Virginia in 1621, and in 1644 went to Cambridge, Massachusetts. He was appointed a captain of the militia and a member of the house of deputies, was speaker of the house in 1651, was chosen magistrat in 1652, and in 1656 was appointed superintendent of all the Indians acknowledging the government of Massachusetts, retaining the office until his death. In 1681 he became major-general of the colony. He wrote *Historical Collections of the Indians of Massachusetts* (published posthumously), and a *History of New England*, which was lost and never published. He died at Cambridge, Massachusetts, March 19, 1687.

GOORKHAS, GORKHAS OR GURKHAS, the principal race of NEPAL; q.v., Vol. XVII, pp. 341 et seq.

GOOSANDER. See MERGANSER, Vol. XVI, pp. 35, 36.

GOOSE LAKE lies partly in Jackson County, Oregon, and partly in Siskiyou County, California. It is thirty miles long and ten miles wide, and at the southern end has an outlet called Pitt River.

GOPHER. See *Geomys*, under MAMMALIA, Vol. XV, p. 419. The name is also applied to *Spermophilus*. See also MARMOT, Vol. XV, p. 560.

GOPHER-WOOD. The probable identity of the gopher-wood of Scripture with the cypress is maintained partly on account of the qualities of the wood and partly on account of the agreement of the radical consonants of the names.

GORAL, a kind of goat antelope (*Nemorhedus goral*), inhabiting the rocky heights and lofty table-lands of India. It is of a grayish-brown color, dotted with black, the cheeks and throat

white; the horns are short, inclined, recurved and pointed. It is a wild and fleet animal, hunted for its excellent flesh. An allied species is found in Japan.

GORDIAN KNOT. See ALEXANDER THE GREAT, Vol. I, p. 481.

GORDIUS. See NEMATOIDEA, Vol. XVII, p. 325.

GORDIUS, KING. See GORDIAN, Vol. X, p. 781.

GORDON, SIR ARTHUR HAMILTON, a British colonial governor; born at Aberdeen in 1829. After graduating at Cambridge University, he served as private secretary to his father, the fourth Earl of Aberdeen, who was Prime Minister from 1852 to 1855. In 1854 Sir Arthur became a member of Parliament for Beverley. In 1858 he was attached to Mr. Gladstone's mission to the Ionian Islands. In 1861 Sir Arthur was appointed governor of New Brunswick, Trinidad, Mauritius and of the Fiji Islands in 1875, then just made a British colony. In 1880 he was made governor of New Zealand, and governor of Ceylon in 1883. He was raised to the peerage as Baron Stanmore in 1893.

GORDON, CHARLES GEORGE, a British military hero; "strange compound of Oliver Cromwell and Thomas à Kempis," as he has well been termed, and best known as "Chinese Gordon" or "Gordon Pasha," was born at Woolwich, England, Jan. 28, 1833. He came of a race of soldiers. His great-grandfather, an officer in Lascelles' Regiment, was taken prisoner by a Highland kinsman at Prestonpans. His grandfather, a British officer, fought under Pepperell and beside the American colonists at the capture of Louisburg, and saw the gallant Wolfe die on the Heights of Abraham. His father was an artillery officer, his mother, a daughter of that



GORDON STATUE, LONDON.

Samuel Enderby whose two tea-ships furnished the Boston Tea Party, and another of whose ships discovered Enderby Land. With two brothers, Charles Gordon entered the army of his native land, winning a commission in the Royal Engineers in July, 1852, when for two years this paladin, who was to set the East and the West aflame, helped in the prosaic duties of planning fortifications for Milford Haven. In December, 1854, he sailed for the Crimea, and soon commenced to exhibit in the advanced trenches that fearless fatalism which marked his entire life. His intense religious convictions controlled every action. Milton's lines,

"Necessity or chance  
Approach me not, and what I will is fate,"

were indeed applicable to Gordon's belief in himself. His will he held to be identical with that

of his Maker, whose instrument he felt and knew he was.

He took part, unscathed, in the costly attack on the Redan, was stunned in the trenches by a ricochet round shot, but recovered to help carry "The Quarries" and watch the French storm the Mamelon. One of his fellow-officers here was Lord Wolseley, the future commander-in-chief of the British army, and Gordon's life-long admirer and friend. His magnetic influence was early noticed. The officers were all his friends, the men followed him in the face of murderous fusillades, and his superiors marked him as a man to whom great deeds could be intrusted to be done well. His corps commander reported him for promotion, and he was permitted to accept the French decoration of the Legion of Honor. The terms of the Treaty of Paris kept him for nearly a year delimiting the new boundary line amid Muscovite squalor and Danubian mosquitos. He did similar work in Armenia, and was promoted captain April 1, 1859, after seven years' service. In July, 1860, he was ordered to China, arriving too late for the attack on the Taku forts, but in time to see the Summer Palace at Peking destroyed, and to get over \$250 prize-money. The Taiping rebellion, which had worried China for 12 years, then reached its flood-tide. Hung, its leader, a mission-taught Chinaman, had brought his hordes to the gates of Shanghai itself. The Chinese army, trained to a high state of excellence by the American General Ward, fell, after his death, under the command of an American adventurer named Burgevine. He came to loggerheads with Li Hung Chang, the governor-General of the Kiang provinces, and was dismissed in January, 1863. Then Gordon was placed in command of the European-clad Chinese army. He was but 30, and a brevet major. His officers were of every nationality and character. In two years he fought 33 actions in two campaigns, took numerous walled towns, and crushed the formidable rebellion which had so long wasted the fairest provinces of China. (See also CHINA, Vol. V, p. 652.)

Returning from China in 1865, "as poor as when he had entered it," he performed engineer duties at Gravesend till 1872, establishing ragged schools and spending his scanty pay for his wards, when he went to Bulgaria as commissioner. In 1873, Khedive Ismail of Egypt employed him to open up the regions of the equatorial Nile and the lakes which recent explorations had discovered, a work formerly begun by Sir Samuel Baker. Gordon was appointed governor of the equatorial provinces, and in February, 1874, he marched, with two thousand Egyptian and negro troops, to Gondokoro, on the White Nile. Here he established a chain of fortified posts as far as the great equatorial lakes. He aimed at the suppression of the slave trade, which had formerly been the one great object of Soudanese commerce. The Khedive supported his efforts, raised him to the rank of pasha, and made him governor of all Soudan in 1877.

In 1879, when the new khedive, Tewfik, failed to support him, Gordon resigned his position and returned to England, where he was greeted with enthusiasm. After a brief holiday in Switzerland, he was sent to Mauritius as commanding royal engineer. He became interested in the Seychelles Islands, made curious researches as to the site of the Garden of Eden, and drew up a plan of defense for the Indian Ocean. Afterward he was appointed major-general, and had command of the British troops in Cape Colony till 1882. Then the British government asked him to proceed once more to the Soudan, where the Moslem populations had risen in revolt, defeated the Egyptian armies, and isolated the Egyptian garrisons. On Jan. 18, 1884, he left London for Khartoum to conduct the evacuation of the country. It was a cut-and-run policy at the best. The scene at the depot was curious. The commander-in-chief held open the car door, the Secretary of State for Foreign Affairs purchased his ticket, while Lord Wolseley carried his portmanteau. They had looked their last on a soldier friend. Cairo was reached January 27th, and on February 18th he entered Khartoum. The inhabitants hailed him as "Sultan" and "Father." He made a bonfire of the tax-books and instruments of torture, and sat down to judge in righteousness and equity. The timorous Egyptian soldiery were sent to safety, and with his trusty Soudanese, whom he refused to desert, the lion-hearted, simple soldier waited for the end. The Mahdi and his fanatics soon closely invested the city, in which Gordon did miracles in the way of defense. His companion in arms, Colonel Stewart, was killed on the Nile, and on Jan. 28, 1885, two days before a relieving advance guard of English soldiery reached the city, Gordon perished, a victim to treachery, and Khartoum was in the hands of the Mahdi.

Neglected and deserted by his country, thus fell one of the noblest soldiers of the Anglo-Saxon race. A serpent in military wisdom, in the ways of the world he was as simple as a little child. Religious enthusiast and fatalist to the core, he believed his end foreordained from all time. The ragged waifs of Woolwich were his kings, and their well-doing his great reward. Curious mixture of mediæval Crusader and modern Christian, Quixotic in impulse at times, the idol of the soldiery and the beau-ideal of his superiors, he won with his simple faith the reverence of the English-speaking world.

If posthumous homage can atone for those long, weary days in the heart of torrid Egypt, when straining eyes watched the mirage of the desert, and at times wondered if its fanciful forms were the dust raised by a tardy column of rescuers, the shame of England's desertion of her soldier-martyr may be yet obliterated. But three statues in the metropolis are decorated on the anniversaries of England's three great losses—Nelson, who would have looked with his sightless eye on an order to retreat, and Beaconsfield, who would have rescued Gordon if it bankrupted an empire share in the honors paid to one of "the bravest

of the brave.' But the paladin, who, while he lived as "one of Plutarch's men, talked with us face to face," outranks the peers. The last and most fitting homage came in August, 1896, when Li Hung Chang, Viceroy of China, visiting Trafalgar Square, London, bent in ceremonious reverence before the bronze presentment of him whose herculean efforts had done so much for the Flowery Land.

Among his published writings were *Reflections in Palestine* (1884); *Letters from the Crimea, the Danube and Armenia* (1884); *Letters to his Sister* (1888); *The Journals of Major-General C. G. Gordon, C.B., at Khartoum*, printed from the original MSS. (1885); *General Gordon's Last Journal*, a lithographed fac-simile (1885); *Private Diary of Exploits in China* (1885); *Diary of the Taiping Rebellion* (1890). Many biographies of Gordon have also appeared; among them, Archibald Forbes's *Chinese Gordon*, and Egmont Hake's *Life of General Gordon*, from each of which many facts have been drawn for this article.

GORDON, GEORGE HENRY, an American soldier; born in Charlestown, Massachusetts, July 19, 1825; graduated at West Point in 1846, and was wounded at Cerro Gordo, in the Mexican War. He resigned to practice law, but in 1861 re-entered the service, fought at the second battle of Bull Run, commanded a brigade at Antietam, took part in the operations against Mobile, and was brevetted major-general of volunteers. He wrote a *History of the Second Massachusetts Regiment of Infantry* (1875); *History of the Campaign of the Army of Virginia under John Pope from Cedar Mountain to Alexandria* (1879); *A War Diary of Events in the War of the Great Rebellion* (1882); and *Brook Farm to Cedar Mountain* (1883). He died in 1886.

GORDON, JOHN BROWN, an American soldier and public man; born in Upson County, Georgia, Feb. 6, 1832. He was educated at the University of Georgia, and served in the Confederate army, being rapidly promoted from captain to major-general, and was eight times wounded in battle. In politics a Democrat, he was a Presidential elector in 1868 and 1872, and a delegate to the national Democratic conventions of those years.



GEN. J. B. GORDON.

In 1872 he was sent by the state legislature to the United States Senate to succeed Joshua Hill. He resigned in 1880, took an active part in state politics, and was governor of Georgia from 1886 to 1890. In 1890 he was elected to the United States Senate to succeed Joseph E. Brown, and was re-elected in 1891.

GORDON-CUMMING, CONSTANCE FREDERICA. See CUMMING, GORDON C. F., in these Supplements.

GORDONIA, a genus of plants of the family *Ternstroemiaceae*. *G. Lasianthus*, the loblolly-bay, which covers considerable tracts of swampy coast along the Atlantic from Virginia southward, and

along the Gulf of Mexico, is a handsome shrub or small tree, with evergreen leaves, and large, white, fragrant flowers. The bark is used in tanning. *G. pubescens*, also called *Franklinia*, grows in Georgia and Florida. The genus is closely related to the camellias and teas.

GORDONSVILLE, a village of Orange County, northern central Virginia, on the North Anna River, and on the Chesapeake and Ohio railroad, at its junction with the Southern railroad, 87 miles S.W. of Washington, District of Columbia. It has several factories and a trade in grain and agricultural produce. Population, 1900, 603.

GORE, CHRISTOPHER, an American lawyer and public man; born in Boston, Massachusetts, Sept. 21, 1758; graduated at Harvard in 1776; studied law and practiced in Boston, and was United States district attorney for Massachusetts from 1789 to 1796, being the first to hold that office. He was appointed in 1796, with William Pinckney, commissioner to England to settle the French spoliation claims (q.v.), and succeeded in securing the restitution of much property. He remained in England for seven years and was then appointed *chargé d'affaires* in London; after holding this position one year, he returned to the United States in 1804, and was elected governor of Massachusetts in 1809, and United States Senator in 1814. In 1817 he was a Presidential elector, and then retired from active political life. Among his chief bequests was one to Harvard College of \$100,000, and Gore Hall, the library building, was named in his honor. He died at Waltham, Massachusetts, March 1, 1827.

GORE, GEORGE, a British physicist; born in Bristol, in January, 1826; attended private schools, but was otherwise entirely self-taught. He studied so successfully that he made an international reputation in electrical research and discovery. He was elected a fellow of the Royal Society in 1865; the degree of LL.D. was conferred upon him by the University of Edinburgh in 1877. Among his many important achievements may be mentioned that of the discovery of "explosive antimony"; his invention of the "voltaic balance," by means of which he was able to prove the existence of new chemical substances known as "solution compounds," etc. He was the first to apply commercially the process of electroplating. Among his publications are *Theory and Practice of Electrodeposition* (1856); *The Art of Electrometallurgy* (1877); *The Art of Scientific Discovery* (1878); *The Scientific Basis of National Progress and Morality* (1882); *Electrochemistry* (1885); and *The Art of Electrolytic Separation and Refining of Metals* (1890). In 1891 he received a civil-list pension of \$750 a year in recognition of his valuable services to British science.

GÖRGEI, ARTHUR, the commander-in-chief of the Hungarian forces during the revolt of 1848-49. He was born at Toporecz, Hungary, Feb. 5, 1818; received a military education and entered the Hungarian Body Guard, resigned in 1845 to study chemistry at Prague, and rejoined

the army at the time of the uprising against Austria. In 1848 he distinguished himself by compelling Jellachich's Croatian reserve of 10,000 men to capitulate to him. In March, 1849, he was made commander-in-chief. For an account of his military operations, see HUNGARY, Vol. XII, pp. 372, 373. After his surrender in August, 1849, Görgei was imprisoned for some time at Klagenfurt, in Carinthia, but eventually set at liberty. In *My Life and Acts in Hungary* (2 vols.; London, 1852) he wrote a comprehensive account of the revolutionary period. In 1868 he returned to Hungary.

GORGES, SIR FERDINANDO, a British "lord-proprietary" of Maine; born at Ashton, England, about 1565. During the war with Spain he served in the English army, and in 1604 became governor of Plymouth. He then became interested in the colonization of the New World, and formed a company for that purpose. After several unsuccessful attempts at settlement, the council resigned its charter, and in 1639 Gorges obtained a new charter, which constituted him lord-proprietary of the province of Maine. He divided it into two counties, and these were further divided into hundreds and parishes. In 1640 he sent his nephew, Thomas Gorges, to Maine as deputy governor. In 1642 he chartered the city of Gorgiana, Maine, afterward renamed York. Sir Ferdinando died in England in 1647. A grandson, Ferdinando, disposed of his rights in Maine to Massachusetts in 1677 for £1,250.

GORGONIDÆ. See CORALS, Vol. VI, p. 385.

GORHAM, a village of southern Coos County, northern New Hampshire, situated on the Androscoggin River, and on the Grand Trunk and the Boston and Maine railroads, 91 miles N.W. of Portland, and about ten miles N.E. of Mount Washington, in the White Mountains. It has fine scenery, and is a favorite place of summer resort. Population 1890, 1,710; 1900, 1,797.

GORHAM CONTROVERSY, a controversy that raged in the Church of England in regard to baptismal regeneration. It arose out of the refusal of Dr. Henry Phillpotts, bishop of Exeter, to institute the Rev. George Cornelius Gorham (1787-1857), then holding a curacy in the diocese, to the vicarage of Brampford Speke, in the same diocese, which had been presented to the latter by the Lord Chancellor on behalf of the Queen. The grounds of refusal were, that Mr. Gorham held unsound doctrine as to the efficacy of the baptismal sacrament, in so far that infants are not made therein members of Christ and the children of God, as the catechism and formularies of the church declare them to be. Mr. Gorham brought the case before the Court of Arches of Canterbury, which decided, in 1849, that baptismal regeneration is the doctrine of the church, thus upholding the bishop; the case was therefore dismissed, with costs. Mr. Gorham then appealed to the judicial committee of the Privy Council, which found that opinions in no important particular to be distinguished from those held by Mr. Gorham had been maintained

without censure by many eminent prelates and divines of the church, and that therefore such points of difference had been left open, and were not thought to be inconsistent with subscription to the Articles of Faith. The judgment of the Court of Arches was thus reversed. After some further litigation, Mr. Gorham was reinstated in his vicarage. The question was a burning one among the controversialists of the church during the two years it was in the courts. See PUSEY, Vol. XX, p. 117; and STANLEY, Vol. XXII, p. 451.

GORILLA. See APE, Vol. II, p. 149.

GORITZ, an Austrian town. See GÖRZ, Vol. X, p. 788.

GORMAN, ARTHUR P., an American public man, conspicuous in connection with the tariff legislation of 1894; born in Howard County, Maryland, March 11, 1839; and educated in the public schools of his native county. In 1852 he was appointed page in the Senate of the United States, and continued in the service of the Senate until 1866, when he was postmaster. He was subsequently



ARTHUR P. GORMAN.

collector of internal revenue for the fifth district of Maryland (1866-69), member of the house of delegates of the Maryland legislature, as a Democrat (1869), speaker of that house (1871), and Maryland state senator (1879). He was elected to the United States Senate in January, 1880, as a Democrat, to succeed William Pinkney Whyte. He took his seat in this last capacity, March 4, 1881, and was re-elected in 1886, and 1892 for the term expiring March 3, 1899. He became president of the Chesapeake and Ohio Canal Company in 1872, of which corporation he had been a director since the year 1869.

GORRINGE, HENRY HONEYCHURCH, an American naval officer; born in Barbadoes, West Indies, Aug. 11, 1811; died in New York City, July 7, 1885. He went to the United States as a lad, and entered the United States navy as a sailor; in July, 1862, rose to the rank of commander, and when, in 1879, the Khedive of Egypt offered to the United States one of the noted Alexandrian obelisks, he was commissioned to bring it to this country. He arrived at Alexandria, Oct. 16, 1879, and with the assistance of one hundred natives entered on his labors. On Dec. 6, 1879, the stone was moved from its pedestal and placed in a horizontal position, an iron steamer was purchased at a cost of twenty-five thousand dollars, and the obelisk introduced through an opening made in the side of the vessel. It was safely transported to New York City, arriving July 20, 1880, and was conveyed from the Hudson River to Central Park. The shaft is 69 feet high, was erected at Heliopolis about 1600 B.C., and removed to Alexandria in the year 22 B.C. The



total expense of its removal and erection in the park amounted to over one hundred thousand dollars. Gorrington published a *History of Egyptian Obelisks* (1885).

GORTON, SAMUEL, the founder of the sect of Gortonians or Nothingarians; born at Gorton, England, about 1600; died in Rhode Island, 1677. He was for a time employed by a linen-draper of London, but in 1636 sought religious freedom in Boston, Massachusetts. Becoming involved in disputes, he removed to Plymouth; was accused of heresy and expelled from the colony; went with a few followers to Aquidneck (now Newport), Rhode Island, and was there publicly whipped for treating magistrates with contempt. He then settled at Pawtuxet, Rhode Island, but again became involved in disputes with the colonists, and in 1642 removed to Shawomet (now Warwick), Rhode Island, where he purchased land of the Indians. His claim to the property was contested; he and his ten followers were taken to Boston, tried as heretics, and sentenced to imprisonment and hard labor; but the sentence was afterward commuted to banishment. Gorton then went to England, procured an order giving him possession of the lands at Shawomet, returned there, and subsequently became a preacher and magistrate of much consideration. His sect survived him for nearly one hundred years. They were known as "Gortonians," and termed "Nothingarians" because they refused all set forms in religious worship and had no ministry.

GORTSCHAKOFF, PRINCE ALEXANDER MICHAËLOVITCH, a Russian statesman; born July 16, 1798. He entered the diplomatic service in 1824, and in 1841 was ambassador extraordinary to Stuttgart to arrange a marriage between the Crown Prince of Würtemberg and the Princess Olga, sister of the Emperor Nicholas. During the Crimean War (1854-56) he was ambassador at Vienna, and then became Minister of Foreign Affairs. In 1863 he was appointed Chancellor of the Empire, and from this time until the ascendancy of Bismarck, he was the most powerful minister in Europe. In 1870, on the occasion of the Franco-Prussian war, he announced that Russia would no longer be restricted in her rights in the Black Sea as defined by the treaty of 1856, his demands being conceded at the London conference of 1871. He participated in the famous Berlin conference of 1878, yet it was evident that his prestige as a diplomat was then waning; in 1882 he retired from public life and went to Baden-Baden, where he died, March 11, 1883.

GOschen, GEORGE JOACHIM, an English statesman; born in London, Aug. 10, 1831, of German parents; educated at Oxford; engaged in mercantile pursuits from 1853. In 1863 he was elected to Parliament for London as a Liberal; in November, 1865, became vice-president of the Board of Trade, and in 1866 was made chancellor of the Duchy of Lancaster. In the Gladstone ministry of 1868 he was president of the Poor Law Board, and from March, 1871, until February, 1874, was First Lord of the Admiralty. Becoming dissatis-

fied with the course of the Liberal party on the question of extension of the franchise, he withdrew from Parliament in 1878. He was many years connected with a leading banking firm in London, and in 1876 he concluded an arrangement with the Khedive for a reorganization of the bonded debt of Egypt. In 1883 he was sent to Constantinople as a special representative to arrange disputed questions with the Sultan. He succeeded Lord Randolph Churchill as Chancellor of the Exchequer in the Salisbury ministry in 1887, as a Liberal-Unionist, resigning with his colleagues in 1892. At the general elections in 1892 and 1895, he was again returned for St. George's, Hanover Square, Middlesex, and in the latter year became a member of Lord Salisbury's Cabinet, as First Lord of the Admiralty. He was lord rector of Aberdeen University (1888), and published *The Theory of Foreign Exchanges* (1863-90).

GOSHEN, a city and the capital of Elkhart County, central northern Indiana, midway between Chicago and Toledo, on the Cleveland, Cincinnati, Chicago and St. Louis and the Lake Shore and Michigan Southern railroads. Elkhart River furnishes abundant water-power, and great quantities of lumber are manufactured here. There are flour-mills, a woolen-mill, oil-mill and plow factories. Its lumber trade averages 20,000,000 feet annually. Population 1890, 6,033; 1900, 7,810.

GOSHEN, a railroad junction and one of the capitals of Orange County, southeastern New York, on the New York, Lake Erie and Western and the Lehigh and New England railroads, 52 miles N.W. of New York. Dairying is the chief business; tiles and bricks are also made. It has very good water-works. Population 1900, 2,826.

GOSNOLD, BARTHOLOMEW, an English navigator; born in England about the middle of the sixteenth century; died in Virginia, Aug. 22, 1607. He was associated with Sir Walter Raleigh in his attempt to found a colony in Virginia, and later headed an expedition fitted out by the Earl of Southampton to found a colony in New England. On March 26, 1602, he left Falmouth for this purpose, with a ship and twenty colonists, attempting to cross the ocean in a direct line. Contrary winds took his vessel to the Azores, whence, after a tedious voyage of seven weeks, he reached the coast of Maine. Following the coast south, he anchored near York Harbor on May 14th, and discovered and named Cape Cod, May 15th. The navigators landed on an island near the mouth of Buzzard's Bay, which they named Elizabeth, in honor of the Queen, and left after a hard winter. Gosnold then united with the company of which Captain John Smith was a leader, to locate in Virginia. They received their charter April 10, 1606, the first granted for a British settlement in North America. On December 19th Gosnold left England with three small ships and about one hundred colonists, and in 1607 they reached James River and settled Jamestown. The place was unhealthful and within a year Gosnold and half the colonists died.

GOSSAMER. See ARACHNIDÆ, Vol. II, p. 296.

GOSSE, EDMUND WILLIAM, an English poet and litterateur, only son of Philip Henry Gosse,



EDMUND W. GOSSE.

the naturalist; born in London, Sept. 21, 1849, and educated in Devonshire. In 1867 he was appointed assistant librarian in the British Museum, and in 1875 became translator to the English Board of Trade. In the seventies he paid repeated visits to the countries of Northern Europe, for the purpose of studying Scandinavian literature, the fruit of which appeared in his *Studies in Northern Literature* (1879), and in his translations and editings of the novels of such writers as Björnson, Jonas Lie and other Norwegian authors, and in reviews of works by Scandinavian and Dutch writers in the London critical journals. His poetical work is represented by *Madrigals, Songs and Sonnets* (1870); *On Viol and Flute*, a collection of lyrics of much beauty (1873); *King Erik*, a tragedy (1876); *The Unknown Lover*, a drama (1878); *New Poems* (1879); *Firdausi in Exile, and Other Poems* (1886); and *Russet and Silver* (1894). In English poetical biography and criticism he wrote a *Life of Gray* (1882); a *Life of Congreve* (1888); *From Shakespeare to Pope* (1885); *Seventeenth-Century Studies* (1883); *History of Eighteenth-Century Literature* (1889); *Gossip in a Library* (1891); and *The Jacobean Poets* (1894). In 1880-81 he contributed numerous critical essays for Humphry Ward's *English Poets*, and in 1886 for the English Worthies Series, a monograph on *Sir Walter Raleigh*. In 1892 appeared a mediæval romance, *The Secret of Narcisse*, in 1893 a collection of essays entitled *Questions at Issue* and in 1896 *Critical Kit-Kats*.

GOSSE, PHILIP HENRY, a British zoölogist; born at Worcester, April 10, 1810; died in Torquay, Devonshire, Aug. 23, 1888. In 1827 he went to Newfoundland as a clerk, and was afterward, in turn, a farmer in Canada, schoolmaster in Alabama, and professional naturalist in Jamaica. Returning to England, he published, in 1840, the *Canadian Naturalist*, and, after another stay in the West Indies, settled in England, devoting himself to literary work. He was elected a fellow of the Royal Society in 1856. Among his works, besides the one named, are *Birds of Jamaica* (1847); *Natural History of Birds, Reptiles and Fishes* (1848-51); *British Ornithology* (1853); *History of the Jews* (1851); *Assyria* (1852); *The Aquarium* (1854); *History of British Sea-Anemones* (1858); *The Romance of Natural History* (1860); *Land and Sea* (1865); *The Great Atlas Moth of Asia* (1879). Many of the illustrations of these were original, and his works are still valued in the market on account of their colored plates.

GOSSELIN, PASCAL FRANÇOIS JOSEPH, a French geographer; born at Lille, Dec. 6, 1751. From

1772 to 1780 he traveled in the East for the purpose of working out its ancient geography. In 1789 he was elected a deputy to the National Assembly; became a member of the Central Administration of Commerce in 1791, and a member of the Ministry of War (1794). In 1790 he was elected to the Institute, and in 1799 succeeded Barthélemy as keeper of the medals in the National Library. Among his important geographical works are *Géographie des Grecs Analytée* (1790); *Recherches sur la Géographie des Anciens* (4 vols., 1798). He died in Paris, Feb. 7, 1830.

GOSSYPIMUM, the genus whose species yield cotton, belonging to the family *Malvaceæ*, or malvols. They are herbs or shrubs, with lobed leaves, purple, yellow or white flowers, subtended at base by an involucre of three large, heart-shaped, leaf-like bracts, and numerous seeds, upon whose surface is developed the abundant cotton fibers. *G. herbaceum*, whose leaves have five short and roundish lobes, is the common cotton-plant of the South; *G. Barbadosense*, whose leaves have five taper-pointed lobes, yields the Barbados or Sea Island cotton, while *G. arborcum*, the tree-cotton of the South, is cultivated only for ornament.

GOT, FRANÇOIS JULES EDMOND, a French comedian; born at Lignerolles (Orme), Oct. 1, 1822; received his education at the Collège Charlemagne; entered M. Provost's class at the Conservatoire, where, in 1842, he carried off the second, and in 1843, the first, prize for comedy. After a year's compulsory service in the army, he made his first bow to a Parisian audience in 1844, at the Comédie Française, of which society he became a member in 1850. M. Got's reputation steadily increased, until he became recognized as one of the greatest actors on the French stage. He excelled in the representation of the leading comic parts in the old classical dramas, and created scores of characters in modern pieces. On Aug. 4, 1881, M. Turquet, the Under-Secretary of State for Fine Arts, publicly conferred the cross of the Legion of Honor on M. Got, he being the first French actor to receive this distinction.

GÖTA ELF, a river of southern Sweden, about 55 miles in length, discharging the waters of Lake Wener into the Cattegat; noted for the romantic grandeur of its scenery and its cataracts, of which Trollhätta is the most beautiful. It is made navigable and is connected with the Baltic by means of canals and Lakes Wener and Wetter.

GOTHA. See SAXE-COBURG AND GOTHA, *post*, p. 2641.

GOTHA ALMANAC (*Almanach de Gotha*), a universal political register, published annually at Gotha, in Germany. It was issued in the German language from 1764 to 1804, and from the latter date till the present has been published both in French and German.

GOTHAM, a parish of Nottinghamshire, England, whose people were long famed for their stupidity, being termed, in derision, "the wise men of Gotham." The name was, by Irving, humorously applied to the city of New York, and the appellation is still a familiar one in the United States.

**GOTHENBURG PLAN OR SYSTEM.** See LIQUOR LAWS, in these Supplements.

**GOTHIC ARCHITECTURE.** See ARCHITECTURE, Vol. II, p. 425.

**GOTHIC LANGUAGE.** See GOTHS, Vol. X, pp. 852-854.

**GOTHLAND**, the southernmost province of Sweden, bounded by the Skager-Rak, Cattegat, Baltic Sea and the province of Svealand. It is well watered, rich in lakes, and fertile. Its scenery is beautiful. The southern part is devoted to agriculture. The northern part produces iron, copper, alum, nickel and other ores. Area, 35,803 square miles; population 1891, 2,595,236.

**GOTLAND**, an island in the Baltic Sea, belonging to Sweden, 60 miles W. of the province of Gothland. Communication with the mainland is had by means of a submarine telegraph. It is about 65 miles long by 30 wide. Area, 1,219 square miles. Population 1894, 51,495, mostly engaged in agriculture, shipping and fishing.

**GOTTSCHALK, LOUIS MOREAU**, an American pianist and composer; born in New Orleans, Louisiana, May 8, 1829; died at Tijuca, Brazil, Dec. 18, 1869. He early showed marked musical ability, and at the age of 12 was sent to Paris, where he studied the piano with Hallé and Camille Stamatz, and harmony with Maleden. He appeared in 1845, in Paris, at a concert, and gave promise of coming distinction as a performer on the pianoforte. Later he gave concerts in Spain and Switzerland, and in 1853 returned to the United States. His first concert was given in Boston; thereafter he made the rounds of other cities, and visited Mexico and the West Indies. He was engaged to perform in Rio Janiero during a musical festival in November, 1869, and on the second evening's performance was taken seriously ill, and died December 18th. He composed many piano solos which became popular, a cantata, and a symphony entitled *La Nuit des Tropiques*.

**GÖTZ VON BERLICHINGEN.** See BERLICHINGEN, GÖTZ VON, in these Supplements.

**GOUGH, JOHN BARTHOLOMEW**, an American temperance lecturer; born at Sandgate, Kent, England, Aug. 22, 1817; died in Philadelphia, Pennsylvania, Feb. 18, 1886. At the death of his father in 1829, he went to the United States, and was for a time employed on a farm in Oneida County, New York; in 1831 he went to New York City, where he became a bookbinder. After some years of poverty, caused by dissipated habits, which finally reduced him to the utmost

misery, he reformed and devoted himself to the temperance cause, laboring with great zeal and success. He visited England in 1853 by invita-

tion of the London Temperance League, and lectured for two years in the United Kingdom. His publications include *Autobiography* (1870); *Temperance Lectures* (1879); *Sunlight and Shadow; or, Gleanings from My Life-Work* (1880).

**GOULBURN, EDWARD MEYRICK**, English clergyman, and author; born in London, Feb. 11, 1818; educated at Eton and Oxford, from which he graduated with first-class honors; elected fellow of Merton College (1841); head master of Rugby (1850-58); prebendary of St. Paul and chaplain to the Queen (1859); dean of Norwich (1866). He published a number of devout books worked out of his sermons, which were much read, and owed their popularity as much to their charm of style as to their high intellectuality and practical piety. Other works, such as his *Devotional Studies of the Holy Scriptures; Thoughts on Personal Religion; The Idle Word; and Pursuit of Holiness*, reached a number of editions. He wrote, also, several controversial works; held to a strict allegiance to the Athanasian creed; discussed liturgical and ecclesiastical themes; and wrote on the antiquities of Norwich Cathedral. Died in Tunbridge Wells, May 3, 1897.

**GOULD, BENJAMIN APTHORP**, an American educator, born at Lancaster, Mass., June 15, 1787; graduated at Harvard (1814); principal of Boston Latin School up to 1828, contributing greatly to the fame of that institution. His *Adams's Latin Grammar* (1825), and his annotated editions of *Ovid, Horace, and Virgil*, were among the earliest efforts of the kind in America. On account of ill health he abandoned teaching and engaged in the China and East India importing business. Died in Boston, Oct. 24, 1859.

**GOULD, BENJAMIN APTHORP**, an American astronomer and statistician, son of the preceding; born in Boston, Massachusetts, Sept. 27, 1824; Harvard graduate (1844); master of the Roxbury Latin School; studied for several years in the Paris, Berlin, Greenwich, Göttingen and Altoona observatories; was a pupil of François Arago. He returned to the United States in 1848, and in 1851 took charge of the longitude determinations of the United States Coast Survey, using the telegraphic method adopted later in Europe. After the first transatlantic cable was laid in 1866, he joined the meridian systems of the two continents by precise observations. By his efforts a connected series of longitude measurements was established from New Orleans to the Ural Mountains. He successively organized and managed the Dudley Observatory, in Albany, New York, from 1856 to 1859, and the Argentine Republic's observatory at Cordoba, from 1868 to 1885, where he made a number of photographs of precision for all important southern clusters of stars, from 1872 to 1884. Returning to Cambridge in 1885, he resumed publication of his *Astronomical Journal*, previously published, at his own expense, from 1849 to 1861, and open only to original observations. In 1862 the United States Sanitary Commission placed him in charge of their statistics, when he elaborated an entirely new system of anthropological measurements, deducing formulæ which have been verified by subsequent research, and exhibiting the typical proportions of the human body. These



JOHN B. GOUGH.

observations were published in tabulated form, under the title of *Military and Anthropological Statistics of American Soldiers* (1869). Among his astronomical writings, the most noted are *On the Transatlantic Longitude* (1869), and *Zone Catalogue*, containing more than 105,000 observations of 73,160 stars. He died at Cambridge, Massachusetts, as the result of an accidental fall, Nov. 27, 1896.

GOULD, HANNAH FLAGG, an American poetess, a sister of Benjamin Apthorp, the elder; born in Lancaster, Massachusetts, Sept. 3, 1789. She was the constant companion of her father (a soldier and patriot, wounded at the battle of Lexington), and her first verses were imbued with true Revolutionary fire. Her poems, published from 1832 to 1854, in magazines and book-form, were much admired, both in England and America. She died in Newburyport, Massachusetts, Sept. 5, 1865.

GOULD, JAY, an American financier; born at Roxbury, New York, May 27, 1836. His only education, outside of a village school near his father's farm, consisted in a few months' stay at the academy at Hobart, New York, where he paid his expenses by keeping a blacksmith's accounts. He early developed a taste for mathematics and surveying, and on leaving school was employed in making surveys for county maps, in which he displayed great skill and accuracy. His work covered Ulster and Dela-



JAY GOULD.

ware counties, a history of the latter being published by Mr. Gould in 1856. Accumulating five thousand dollars out of his earnings, he invested it, in 1856, in a tanning and lumber business. Meanwhile, in the school of hard experience, he gradually acquired the shrewdness of insight, talent for direction, and rare capacity for labor, which were destined to culminate in the acquirement of a colossal fortune. The lumber venture prospered; but just previous to the panic of 1857 he sold his plant and put his small capital into stock of the bank of Stroudsburg, Pennsylvania. After the financial crisis, he bought the bonds of the Rutland and Washington railroad at ten cents on the dollar, and managed this railroad practically alone, and in 1859 he established himself as a broker in New York City. He and his business associate, James Fisk, Jr., were connected with the panic in the New York gold-room known as "Black Friday" (1873). He succeeded Fisk as president of the Erie Railway Company till 1872, and afterward invested largely in the stocks of other railways (Union Pacific, Wabash, Missouri Pacific, etc.) and telegraph companies (Atlantic Pacific and Western Union), and in 1881 became interested in the elevated-railroad system of New York City. In 1882, a question of his financial stability having arisen, Mr. Gould produced for examination stock-certificates in his own name having a face value of \$53,000,000, and offered to produce \$20,000,000

more if desired. In 1887 it was estimated that he controlled over 13,000 miles of railway, or nearly a tenth of the entire mileage of the country. He died Dec. 2, 1892, leaving an estate generally valued at \$70,000,000.

GOULD, JOHN, an English ornithologist; born at Lyme, Dorsetshire, in 1804. From an early age he interested himself in the study of natural history, and in 1824 became employed in preparing specimens for the museum of the London Zoölogical Society, of which he became curator in 1827. He gave much attention to humming-birds, and collected more than two thousand specimens, illustrating three hundred and twenty species. He died Feb. 3, 1881. For an account of his works, see ORNITHOLOGY, Vol. XVIII, p. 12.

GOULD, THOMAS R., an American sculptor; born in Boston, Massachusetts, in 1818. He early engaged in mercantile business, and did not devote himself to art until later in life, his first work being done in 1851, when in the studio of Seth Cheney, the crayon artist and engraver, his sole instructor. His colossal heads of *Christ* and *Satan* (1863) were among the most important of his earlier efforts. He followed his profession in Boston until 1868, when he went to Italy and settled in Florence. In 1878 Mr. Gould visited Boston. Among his most celebrated works are *The West Wind* (Centennial Exhibition, 1876); *Cleopatra*; *Timon of Athens*; the *Ghost*, in *Hamlet*; and *Ariel*. He also executed several portrait statues; among them, one of *John Hancock*, now in Lexington Town Hall, and a number of busts. Died in Florence, Italy, Nov. 26, 1881.

GOUNOD, CHARLES FRANÇOIS, a French composer; born in Paris, June 17, 1818. He received his musical education at the Paris Conservatory, where he enjoyed the instruction of the celebrated composers, Halévy and Lesueur. In 1839 he won the annual *grand prix*, offered by the National School of Fine Arts, by his cantata *Fernand*, and was thereby enabled to go to Rome for further study. At Rome



CHARLES F. GOUNOD.

he entered a priests' seminary for the purpose of devoting himself to old Italian church music. In 1843 he returned to Paris, and became musical director of the Catholic Church of Foreign Missions, which position he held for six years. In 1851 he produced a *Messe Solennelle*, his first great success. After that, inspired by the famous cantatrice Pauline Viardot-Garcia, he gave his attention more to secular music, producing first the lyric drama *Sappho* and several pastorals, which were not much appreciated. But his *Faust*, which appeared in 1859, captivated the French and even the most difficult to please among the Germans, and placed him in the front rank of modern composers. Afterward he composed other less popular operas, including *Philémon et Baucis*; *La Reine de Saba*; *Mireille*; *La Colombe* ("The Pet Dove"); and *Romeo and Juliet*—all from 1860 to 1867. The war of 1870

drove him to London, but he returned to Paris in 1875, and there produced the opera *Polycucte* (1878); a cantata, *Gallia*; the opera *Le Tribut de Zamora* (1881); the oratorios *Redemption* (1882) and *Mors et Vita* (1885); also *Messe à Jeanne d'Arc* (1887); *The Funeral March of a Marionette*; and an *Ave Maria* for soprano, violin, and organ. He was a member of the French Institute from 1866, and grand officer of the Legion of Honor from 1880. Died at St. Cloud, near Paris, Oct. 18, 1893. His style was eclectic, with high ideals. He chose his librettos with great care, obtaining much of his inspiration from the merit of the poems.

GOUPIL, JULES BAPTISTE MICHEL ADOLPHE, a French publisher of line-engravings and etchings; born in Paris, March 7, 1806, a grandson of the famous painter, G. Drouais, and the founder of the art-publishing house that bears his name and has branches in Berlin and New York. As early as 1848 he attempted to introduce high-class works of art into America, but found the tariff regulations unfavorable. Later he triumphed over all obstacles, and met with growing success. He devoted much time and money to the preservation and improvement of line-engraving, which threatened to be deserted for lithography. When photographic processes of reproduction were in their infancy he foresaw the immense future before them, and made constant experiments in that direction, in his extensive works at Asnières. He finally succeeded in obtaining color-effects by blending etching and water-colors by methods which are still secret. He obtained the highest distinctions in all leading world's fairs, from that at London (1851) to that at Chicago (1893). Died May 9, 1893.

GOUR. See GAUR, Vol. X, pp. 112-116.

GOURA, the largest and finest genus of the pigeon family. The *G. coronatus*, found in New Guinea, and domesticated in Java on account of its excellent flesh, reaches the size of a turkey. It is characterized by a large fan-like crest on the head and the slaty blue of its wings marked lengthwise with whitish and chestnut stripes. See PIGEON, Vol. XIX, p. 85.

GOURAND, GEORGE EDWARD, an American soldier and promoter; born at Niagara Falls, New York, in 1841; enlisted before his twentieth year, and distinguished himself by unusual bravery; at Honey Hill he rallied, single-handed, a stampeded regiment; at Pocotaligo, with two comrades, he stormed a heavily manned redoubt and captured two cannons. Having left the army as a brevet colonel in 1865, he busied himself with securing capital for meritorious inventions. He managed the European rights of Edison's telephone, electric light and phonograph, and made them financial successes abroad. In 1889 he presented the perfected phonograph to the French Academy of Sciences.

GOURKO, JOSEPH VLADIMIROVITCH, COUNT, a Russian general; born Nov. 15, 1828, of a Polish family. He served as captain in the infantry during the Crimean War. In 1861 he became colonel, when he helped in the suppression of the Polish insurrection; major-general in 1867; and lieutenant-general in 1876. At the outbreak of the war with Turkey in 1877, he commanded the Russian van-

guard. At the Shipka Pass he attacked Suleyman Pasha, and suffered great losses during the heroic struggle of August 16th, 21st and 25th; later, at the head of a corps of cavalry, he invested Plevna, where Osman Pasha resisted him gallantly. Gourko compelled him to surrender, Dec. 10, 1877. After this, Gourko crossed the Balkans in midwinter with 75,000 men—a feat of extraordinary difficulty—and captured Sophia, Philippopolis, etc. At the end of the Turkish war he was made a general of cavalry and a count, and in 1883 military governor of Warsaw, but was superseded by one of the Russian grand dukes, as he treated the Poles with unnecessary severity.

GOVERNEUR, a town of St. Lawrence County, northern New York, situated on the Oswegatchie River, and on the Rome, Watertown and Ogdensburg railroad, 36 miles N.E. of Watertown; settled in 1806; named after Gouverneur Morris, the first proprietor. It contains a seminary and several large mills; better known for its marble-quarries and talc-mines, the latter unique of their kind in the United States. Population 1900, 3,689.

GOVAN, a police burgh of Lanark and Renfrew shires, on the south bank of the Clyde, outside the municipal boundaries of Glasgow, but connected with the city by continuous rows of buildings. Was considered, until the middle of the seventeenth century, one of the largest boroughs in Scotland. Now its leading industries are ship-building and silk-spinning. Population 1891, 61,364.

GOVE, a city and the capital of Gove County, Kansas, 11 miles from Grainfield, the nearest railroad station, on the Union Pacific railroad. It is in a fertile, stock-raising region, several salt-mines and quarries. Population of town and township, 1900, 421.

GOVE, AARON, an American educator; born at Hampton Falls, New Hampshire, Sept. 26, 1839; a graduate of Illinois State Normal University; served during the Civil War as major in the Thirty-third Illinois Infantry (1861-65); appointed city superintendent of schools of Denver, Colorado, in 1874; an organizer of uncommon ability; in 1888 was elected president of the National Educational Association.

GOVERNMENT BY INJUNCTION. See INJUNCTION and DEBS, EUGENE V., in these Supplements.

GOVERNMENT'S ISLAND See ROCK ISLAND, in these Supplements.

GOVERNORS. The pendulum or ball-governor for motors is being displaced in high-class motors by the inertia governor, which gives a much more regular rate of speed than is possible with the older type. In order that the ball-governor may act to reduce the speed of a steam-engine, it is first necessary that the speed of the engine shall increase, and it is also necessary that this increase shall continue a sufficient length of time to overcome the inertia of the balls or weights, and cause them to act on the valves so as to shut off the steam and reduce the speed. In the case of the inertia governor, which is now commonly set in the fly-wheel of an engine or motor, the weights, assisted by springs, are made to operate by their inertia, so that when there is a tendency to increased speed the inertia of the weights,

acting in opposition to this tendency, shall operate the eccentrics, and through them the valves. As a result, a tendency to increased speed can be checked within less than one revolution of a fly-wheel. Inertia is made use of where centrifugal force fails, and both principles exist in the one governor. The centrifugal action sets the pace, and the inertia maintains the rate.

Other forms of governor are known as the fan or fly-wheel governor, because making use of a rotating fan that beats against the air; the gyroscope, or screw-propeller governor, in which a small form of propeller rotates in a liquid; and the hydraulic governor, for any one of various forms in which the resistance of water is utilized to control the speed. See also STEAM-ENGINE, Vol. XXII, pp. 505-508; and MECHANICS, Vol. XV, pp. 768, 769.

GOVERNOR'S ISLAND, a small island about three quarters of a mile in length, in Boston harbor, just two miles E. of the city. At its northern end stands Fort Winthrop, a part of the defense system of the harbor.

GOVERNOR'S ISLAND, an island in New York Bay, a half-mile S. of the Battery, with which it is connected by a regular ferry line. It has an area of about 65 acres, and is, and has been since before the War of 1812, owned and occupied by the War Department. It is now the headquarters of the Department of the East, and has a number of interesting buildings and forts. The last are Fort Columbus and Castle William. There is also a military museum, containing many interesting relics, among them the war-horse, admirably mounted, which Sheridan rode from Winchester to the battle of Cedar Creek.

GOWAN, JOHN E., an American engineer; born in Lynn, Massachusetts, March 6, 1825. Spent most of his life abroad, in the employ of foreign governments; was prominently connected with the successful raising of the Russian fleet sunk by order of the Czar in the harbor of Sebastopol at the beginning of the Crimean War. He died in Paris, France, May 7, 1895.

GOWAN, OGLE ROBERT, a Canadian author and public man; born in County Wexford, Ireland, in 1796. He received a good education, and early became editor of the *Antidote*, a newspaper of Dublin. Removing to Canada in 1829, he resided for a time in Escott, and afterward in Toronto. He served with distinction against the insurrectionists of 1837-39; was a member of the Canadian Parliament from 1834 to 1841, and was for a time post-office inspector and subsequently a license-officer in Toronto. He was the founder of the Orange lodges of North America, and was for twenty years their grand master. He died in Toronto, Canada, Aug. 21, 1876. He wrote *Annals of Orangism*; and *Orangism: Its Origin and History*.

GOWANDA, a village of western New York, on Cattaraugus Creek, the boundary line dividing Cattaraugus and Erie counties, on the Buffalo and Jamestown railroad, 32 miles S. of Buffalo. It has manufactories of flour, agricultural implements, carriages and cheese-boxes. Population 1890, 1,657; 1900, 2,143.

GOWER, MRS. LILLIAN NORDICA. See DOME, MRS. ZOLTAIN F., in these Supplements.

GOWERS, WILLIAM RICHARD, an English physician and specialist in nervous diseases; born in London in 1845; educated at Oxford; graduated as M.D. from London University in 1870; became successively physician to the National Hospital for Paralytics and Epileptics, and professor of clinical medicine at University College; chiefly known on account of his work on the structure and diseases of the nervous system. In his *Manual and Atlas of Ophthalmoscopy* (1890) he indicated the changes occurring within the eye in diseases of the brain, kidneys, etc. The following of his works are considered authoritative, abroad and in America: *Epilepsy and Convulsive Diseases* (1880) and his excellent *Manual of Diseases of the Nervous System* (2 vols., 2d ed. 1890). He was a distinguished amateur etcher, and was elected F.R.S. in 1887.

GOWRIE CONSPIRACY, a plot against the person of King James VI of Scotland by John Ruthven, Earl of Gowrie, and others, in the attempted execution of which Gowrie and his brother were slain. See SCOTLAND, Vol. XXI, p. 509.

GOYAZ, a large province in the central part of Brazil, occupying 288,546 square miles of generally mountainous territory. The climate, in general, is healthy, but in the northern part fever and goitre are common. At one time it was famous for gold and diamonds; but these products are about exhausted. Now the industries are stock and tobacco raising and quartz-crystal mining, of which quantities are exported, known as Brazilian pebbles, and used for the manufacture of lenses. The population, 227,572 in 1890, are mostly half-breeds, though there are a great many wild Indians. The capital, Goyaz, on the river Vermelho, has a population of 8,000.

GRAAFIAN VESICLES OR EGG-SACS, named after Regner de Graaf, who first discovered and described them. See REPRODUCTION, Vol. XX, pp. 407-413.

GRACE, WILLIAM GILBERT, a British cricketer; born near Bristol, England, July 18, 1848. He early evinced a great aptitude for cricket, and in 1864 played with the South Wales team, at Brighton, against the Gentlemen of Sussex. The next year he was eagerly sought for, and his reputation established. Between 1864 and 1879 Mr. Grace completed 415 innings in first-class matches, and obtained, in all, 20,842 runs, the most wonderful record of batting performances, till then, chronicled. He was recognized as the best bat in England, a good bowler, an excellent fielder and a first-rate captain. In 1884 he played three innings of over one hundred against the Australians, and in 1886 his record was equally high. Mr. Grace's skill seems to lose nothing with his advancing years, his score of over two hundred runs occurring twice in the season of 1895. He is a member of the medical profession. He published a valuable book on cricket (1891), and in 1895 received a large sum of money as a testimonial from his thousands of admirers throughout the British Empire.

GRACE NOTES OR GRACES, the English

name for those ornaments (appoggiaturas, etc.) in vocal and instrumental music more correctly known as *agrémens*; said to be the invention of Chambonnières, the celebrated organist of Louis XIV (1670). Their use was regulated for the first time in a work by Emmanuel Bach (1752), who warns musicians against their too frequent use, while admitting that they are of great value in "connecting the notes, enlivening them, and giving them especial emphasis."

GRACIAS, a department and city of Honduras. Gracias, founded in 1536 under the name of Gracias á Dios, is the capital, and a thriving place of some 7,000 inhabitants. See HONDURAS, Vol. XII, p. 130.

GRADIENTIA, same as URODELA. See AMPHIBIA, Vol. I, pp. 751, 770.

GRADUAL. See MISSAL, Vol. XVI, pp. 508, 510.

GRADY, HENRY WOODON, an American journalist; born at Athens, Georgia, in 1851. He was



HENRY W. GRADY.

educated at the State University at Athens, and took a post-graduate course at the University of Virginia. For some time he acted as Southern correspondent of the *New York Herald*. Later, became editor of the *Rome (Georgia) Daily Commercial*, and afterward of the *Atlanta Herald*, and finally, in 1882, he became part owner and managing editor of the *Atlanta Constitution*, which he conducted until his

death. In December, 1886, he accepted an invitation to address the New England Society at their annual dinner. His address was received with the greatest enthusiasm, and the whole country was stirred by his eloquent and impassioned plea for "the New South." He became the idol of his native state, and contributed, in a marked way, to the healing of the feuds between North and South. Just prior to his death he delivered an address on *The Future of the Negro* before the Merchants' Association in Boston. He succumbed to an attack of pneumonia, contracted in New York, and died on his way home, Dec. 23, 1889. A handsome monument and a public hospital were erected in Atlanta, Georgia, to his memory. A biography of Henry Grady has been written by Joel Chandler Harris.

GRÆÆ, in Greek mythology, sisters of the Gorgons, and guardians of the only weapons with which the Gorgons could be overcome. See PERSEUS, Vol. XVIII, p. 560.

GRAF, ARTURO, an Italian litterateur; born in Athens in 1848; studied law in Naples; settled in Roumania for several years; went to Rome as private tutor at the university, 1874; was called to the Turin University in 1876, as professor of the Romance languages, and was appointed, in 1882, to the chair of Italian literature. Best known as a poet and student of middle-age lore, he published several valuable volumes; among them, *Verse* (1874); *Poesie*

*e Novelle* (1876); and, in prose, *Miti, Legende e Superstizioni del Medio Evo* (2 vols., 1891-93). He contributed to the *Nuova Antologia* and other high-class Italian magazines.

GRAFFITI. See PALEOGRAPHY, Vol. XVIII, p. 143.

GRAFTING. See HORTICULTURE, Vol. XII, pp. 213, 214, 236, 237.

GRAFTON, a city and the capital of Walsh County, northeastern North Dakota, on the Park River, 11 miles W. of the Red River of the North, and on the Great Northern and the Northern Pacific railroads. It is the trading-center for a large wheat-growing district, and ships much grain. Population 1890, 1,594; 1900, 2,378.

GRAFTON, a town and the capital of Taylor County, northern West Virginia, on Valley River, and on the Baltimore and Ohio and the Monongahela River railroads. The chief industries are lumber, coal-mining and manufacturing. It has the car-shops of the Baltimore and Ohio railroad, a pump factory, a foundry, and saw and flour mills. Population 1890, 3,159.

GRAFTON, AUGUSTUS FITZROY, DUKE OF, an English statesman; born Oct. 1, 1735. He entered political life by opposing Bute in 1763, and later was Secretary of State in the ministry of the Marquis of Rockingham. In 1766 he became First Lord of the Treasury in Pitt's administration, and on account of the sickness of Pitt was leader after September, 1767. His rule was marked by violence and bribery, and against it were directed many of the letters of Junius. In 1768 he was chosen chancellor of the University of Cambridge, which appointment he held until his death, which occurred March 14, 1811.

GRAHAM, a village and the capital of Alamance County, northwestern central North Carolina, on the Haw River and on the Southern railroad, 50 miles W.N.W. of Raleigh. It has several cotton and tobacco factories, and ships the produce of the vicinity. Population 1890, 991; 1900, 2,052.

GRAHAM, CHARLES KINNAIRD, an American civil engineer; born in New York City, June 3, 1824. He entered the United States navy as midshipman, and after serving in the Mexican War, returned to New York and studied civil-engineering. When the Civil War broke out, he became major of a volunteer corps, and served throughout the war, attaining the rank of brigadier-general, after which he returned to his profession in New York. In 1873 he was appointed chief engineer in the department of docks, and in 1878 surveyor of the port of New York. He died at Lakewood, New Jersey, April 15, 1889.

GRAHAM, SIR GERALD, a British soldier; born in Cumberland in 1831. He entered the Military Academy at Woolwich in 1847, and received his commission as second lieutenant in the Royal Engineers in 1850. He served through the Crimean War, and fought at Alma and Inkermann, and was wounded twice. He received numerous medals, and for conspicuous gallantry was made a knight of the Legion of Honor. He took part in the China war of 1860, and was wounded severely at the assault of the Taku forts.

He was present at the capture of Pekin. In 1882 he commanded a brigade of the division in the Egyptian campaign, receiving the thanks of both Houses of Parliament. He defeated a large force of Arabs at Tamai with great slaughter. In 1885, after the fall of Khartoum, he commanded an expedition to Berber, and commenced the Suakin and Berber railroad. On the 20th of March, 1885, he fought the battle of Illasheen. He was decorated with the grand cross of St. Michael and St. George by Queen Victoria. He contributed to current literature some valuable articles upon military matters, and translated Von Goetze's *Account of the German Engineers' Operations During the Campaign 1870-71*. His *Last Words with General Gordon*, contributed to the *Fortnightly*, was a paper of much public interest.

GRAHAM, JAMES DUNCAN, an American engineer and topographer; born in Virginia, April 4, 1799, and educated at the United States Military Academy. He entered the army as third lieutenant of artillery in 1817, and became adjutant at West Point two years later. During the years 1819-21 he accompanied Major Long on his explorations of the West, and from that time until 1838 he was employed as assistant on military and railway surveys. In 1838 he was made major of topographical engineers, and employed in determining the boundary line between the United States and Texas, and later upon the survey of the northeastern boundary line of the United States, the "Mason and Dixon" line, and the boundary between the United States and the British provinces. He was promoted colonel of engineers in 1863, and engaged on the Coast Survey until his death, Dec. 28, 1865.

GRAHAM, SYLVESTER, an American vegetarian; born in Suffield, Connecticut, in 1794. In 1823 he entered Amherst College, intending to prepare for the ministry, but did not complete the course. He began to preach in 1826, and in 1830 engaged in temperance work. Becoming convinced that intemperance could be cured by the adoption of a purely vegetable diet, he afterward applied the theory to other forms of disease. He published *Essay on Cholera* in 1832, and in 1839 delivered a course of lectures entitled *Graham Lectures on the Science of Human Life*. He also published *Bread and Bread-making; A Lecture to Young Men*; and one volume of *The Philosophy of Sacred History*. His dietetic system occasioned the terms *Grahamism* and *Grahamite*. He died in Northampton, Massachusetts, Sept. 11, 1851.

GRAHAM, WILLIAM ALEXANDER, an American statesman; born in Lincoln County, North Carolina, Sept. 5, 1804. He became a lawyer, and in 1833 was elected to the legislature of North Carolina. Several times he was chosen speaker of the assembly of that state, and in 1841 he was elected United States Senator. From 1845 to 1849 he was governor of North Carolina. When Fillmore became President, he appointed Graham Secretary of the Navy. In June, 1852, the Whig party nominated him for Vice-President, but he was defeated. After this he remained in private life until 1864, when he became a Senator in the Confederate Con-

gress. He died in Saratoga, New York, Aug. 11, 1875.

GRAHAME, JAMES, a Scotch historian; born in Glasgow, Dec. 21, 1790. He graduated at St. John's College, Cambridge, and in 1812 was admitted to the Scottish bar. He subsequently removed to the south of England. In 1827 he published the first two volumes of a history of the United States, and in 1836 a new edition in four volumes, bringing the history down to the year 1776. The work was highly praised by Prescott and other historians, but was not popular in England, because of its thoroughly American spirit. A Philadelphia edition was published in 1845. He died in London, England, July 3, 1842.

GRAHAM OF CLAVERHOUSE, JOHN, VISCOUNT DUNDEE. See DUNDEE, Vol. VII, pp. 536-559.

GRAIN COAST OR MALAGHETTA. See AFRICA, Vol. I, p. 269.

GRAIN-ELEVATOR, a building specially constructed for elevating, storing and loading grain into cars or vessels. The grain-elevator is a building of comparatively recent times, having been constructed to meet the requirements of the immense amount of grain which accumulates in the principal shipping ports of the country. In 1838 but 78 bushels of wheat were received in Chicago; in 1895 more than 200,000,000 bushels of wheat, corn, oats and rye were handled, mainly through the elevators of the city.

There is a similarity in the form of construction of all grain warehouses or elevators, and to describe a typical one is to virtually disclose the plan of all. The foundation, must of necessity, be such as will sustain an immense weight, and where the ground is not firm, solid piles are driven, on which the stone foundations are laid. The structure is built up to a height of from fifty to seventy-five feet without framing, spruce planks being laid flatwise upon each other and spiked together to form the outer walls and bin-divisions. Surmounting this structure is a narrower building, called the cupola, in which the stories are defined by windows. The outside measurement of one such building in Chicago is 550 feet long, 115 feet wide, and the extreme height 156 feet. The building is divided by a fire-wall, in order to decrease the cost of insurance. This is of brick, twenty inches wide at the base, and with openings protected by fire-doors and rolling iron screens. The first floor is twenty feet high, giving head-room for cars, which enter through five tunnels built into the structure. Above this first story extend the bins for 65 feet. These bins run from the covering of the ground floor to the top of the main building, and are from sixteen to twenty feet wide. They open above into the cupola and terminate in hoppers. They are simply rectangular wells formed of plank sides, and having no interior equipment except an iron ladder in one corner. The elevator under description had 8,000,000 feet of lumber used in its construction, and the annex, standing close by, and connected by pipes, required 11,000,000 feet. The cupola of five floors is divided as follows: The one immediately over the bins is known as the "bin" floor; the next, the "spout" floor; the third, the



"scale" floor, and the two top ones are called the "machinery" floors.

The margin in the sale of grain is so small that the most serious problem that the grain merchant now has to meet is to handle a maximum amount of grain with a minimum amount of labor. Cars of grain are received and switched directly into the elevator, standing in one of the tunnels, and the grain removed by machines resembling road-scrappers, which are operated by winch, cable and two men, who drag the grain from the cars into immense iron hoppers, set below the level of the elevator floor. From these hoppers, or tanks, the grain is taken to the top floor through legs, which are large pipes running up through the building, in which run belts, with cups twenty inches long and six inches wide attached. In the elevator under description there are 28 of these legs, any one of which can handle 7,000 bushels of grain per hour. The marine legs are larger, and are able to take 12,000 bushels of grain out of the hold of a canal-boat or lake-barge in an hour. The grain which is taken up through the legs goes directly to the top floor of the cupola. On the second machinery floor is a "garner," a bin which accommodates grain to the extent of 1,000 or more bushels, resting on a scale-hopper on the next floor below. The weighing is all done on the same floor, and is managed the same, whether the grain is for store or for immediate shipment, 16 shipping-bins, garners, shipping-scales and as many spouts leading out to the river front. Four hundred cars can be unloaded in a day, and the equivalent of grain reloaded into vessels. On the spout floor is an ingenious arrangement that receives the grain from the scale-hoppers, and from which the grain can be diverted into any one of 35 bins. When grain out of store is to be loaded, the process is the same as when it has been received by rail. The grain is let from the bins into iron receiving-tanks, then conveyed to the top of the building, discharged into the shipping-bin, and spouted out into the vessel. All grain is weighed as it comes in, and again as it goes out. In loading cars the same method as in loading vessels is used, except that the outlet is a bifurcated spout, which directs the grain to the ends of the cars, thus doing away with shoveling. A 700-bushel car is thus loaded in one and one half minutes. When it is desired to move grain horizontally from one building to another, two methods are used. One consists of an endless screw inclosed in a box; the other is simply an endless belt, along which the grain is made to travel. The belt runs over pulleys at either end of the route to be traveled, and the grain is deposited on it by a contrivance called a concentrator. This concentrator turns up the edge of the belt slightly when depositing the grain, and, as it flattens out again and travels along at a rapid rate of speed, the grain is held to the center by centripetal force. On a 40-inch belt the grain may stand a foot high in the center, while the edges of the belt for four or five inches will be bare of grain. It is possible, by this last-named method, to move 30,000 bushels of grain per hour to a contiguous house.

While grain remains in the elevator it is constantly handled, the principal reason for so doing being to prevent weevil from developing. On the advent of cold weather, all grain in store is at once handled, to allow the heat to escape, and that it may assume the temperature of the outside air.

The first small elevators were operated by hand-power. Then horse-power was introduced. The first to be operated by steam was built in 1848.

The capacity of the elevators of the principal cities from which grain is shipped is: Chicago, 50,000,000 bushels; Duluth, 27,000,000 bushels; Minneapolis, 26,000,000 bushels; New York, 29,000,000 bushels; Buffalo, 15,000,000 bushels; St. Louis, 13,000,000 bushels; Toledo, 7,000,000 bushels.

Many frauds arose in connection with the storage of grain in elevators soon after they came into use, and it became necessary to place them under the control of inspectors, whose duty it is to inspect elevators and certify as to warehouse-receipts and shipments of grain.

So disastrous are fires in elevators that it became a necessity to take extraordinary precautions to guard against them. Insurance companies refuse risks unless the building is divided into small areas by means of fire-walls, and generally require that they shall be covered with corrugated sheet-iron. In addition, they require patent sprinklers, which flood the building in the event of fire reaching the soft metal with which their valves are soldered. Fire-buckets hang at all convenient points, with which incipient blazes may be extinguished, and nearly all of the better class of buildings are provided with Niagara pumps, with which a four-inch stream of water may be thrown entirely over the top of the structure. See also ELEVATORS or LIFTS, in these Supplements.

GRALLATORES, a group of wading-birds. The term is almost equivalent to *Gallæ*, which generally is used. The group has rather indefinite boundaries, and the members usually are distributed in a number of orders. See ORNITHOLOGY, Vol. XVIII, p. 31.

GRAMINEÆ. See GRASSES, Vol. XI, p. 53.

GRAMME. See WEIGHTS AND MEASURES, Vol. XXIV, p. 490.

GRAMMONT, ORDER OF. See GRANDIMONTANES, Vol. XI, p. 47.

GRAMOPHONE, a device invented by Émile Berliner, for recording and reproducing sound. It consists of two essential parts, a recording and a reproducing mechanism. The former comprises a circular disk of zinc that is made to rotate horizontally under a needle-point, or stylus, by any electrical or mechanical motor. The stylus is connected with a diaphragm sensitive to sound-vibrations, and so adjusted as to trace, when in operation, a spiral line on the disk from circumference to center. On the zinc disk a very thin film of fatty substance having suitable viscosity is spread, and when placed in position, this coating receives from the stylus impressions corresponding to the vibrations communicated by the diaphragm. The record thus made is subsequently etched in with chromic acid upon the zinc disk. From this etching a duplicate in relief is made by an electrotyping process, which

is used to press the record into hard rubber plates, and will serve for one thousand reproductions.

The reproducing mechanism consists of a stylus that falls into the grooved lines on the rubber plate, and is governed by a sensitive spring that enables it to receive the vibrations recorded thereon, and transmit them in turn to a diaphragm placed in a sounding-box with a trumpet-shaped opening that augments the sound. The revolution of the plate under the stylus, which may be effected by a hand or pedal crank, or other suitable contrivance, causes the sounds first recorded on the zinc disk to be reproduced audibly.

Thus far the invention is but little more than a source of entertainment. Its manufacturers sell the reproducing mechanism and copies of various recorded songs, words or other sounds as sufficient for the purpose of those who ask only to be amused. The process of record-making is too technical and protracted for popular execution. The device is a sort of mechanical phonograph, and the above statements describe its usual commercial form, which is capable of variation.

D. O. KELLOGG.

GRAMPIANS, a mountain range. See SCOTLAND, Vol. XXI, pp. 523-526. Also the name of a short range of mountains in Australia. See VICTORIA, Vol. XXIV, p. 215, and map.

GRANBERY, JOHN COWPER, an American clergyman; born at Norfolk, Virginia, Dec. 5, 1829. He was educated at Randolph-Macon College, and began his career as a Methodist Episcopal preacher in 1848. During the Civil War he was chaplain in the Confederate army; from 1875 to 1882, professor of moral philosophy and practical theology in Vanderbilt University, Nashville, Tennessee; and in 1882 was made bishop in the Methodist Church. He published a *Bible Dictionary* (1882).

GRANBURY, a town and the capital of Hood County, central Texas, on the Brazos River, and on the Fort Worth and Rio Grande railroad, 30 miles S.W. of Fort Worth. It is the shipping and trading point of the agricultural and stock-raising district surrounding. Population 1900, 1,410.

GRAND, SARAH. See MCFALL, MRS. FRANCIS ELIZABETH, in these Supplements.

GRAND ARMY OF THE REPUBLIC, a patriotic and fraternal association of the survivors of the Union army who served in the Civil War of 1861 to 1865 and were honorably discharged. The national organization is known as the National Encampment of the Grand Army of the Republic, and in it is vested the supreme power, with the right of making rules and regulations to govern the order. Below this are the state organizations, called departments; and in the third place, local organizations known as posts, which are numbered and named after some locality, battle or deceased loyal person, such as a Union soldier or sailor. In 1895 the Grand Army numbered 357,640 members and 7,500 posts. B. F. Stephenson, a surgeon of the Fourteenth Illinois Infantry, was the founder of the organization. The first post was chartered April 6, 1866, at Decatur, Illinois, and the first national convention of veterans was held at Indianapolis, Nov. 20,

1866, and the national encampment of supreme body formed in Philadelphia on Jan. 15, 1868. The rules of the order forbid the discussion of partisan questions at its meetings, or any attempt to make the association a force in partisan politics. Each post is required to establish a relief fund for the assistance of needy comrades, and the wives and families of those deceased who may need aid. The motto of the order is "Fraternity, charity and loyalty," and it is a custom for the members of the different posts to visit the neighboring cemeteries yearly, on Memorial day, and decorate the graves of their fallen comrades. The original purpose of the organization was to emphasize by mutual assent the principles of union and national honor to which its members had given devoted adherence in the field. It followed, as a matter of course, that no person who had at any time borne arms against the United States could be eligible to membership. At the same time, a spirit of national fraternity is inculcated by the motives and practice of the order. In the occasional gatherings where Union and Confederate veterans have associated, there has been always manifest the soldierly magnanimity due to a worthy foe.

Appended is a list of encampments, together with the commanders-in-chief of the order: 1866, Indianapolis, Stephen A. Hurlbut, Illinois; 1868, Philadelphia, John A. Logan, Illinois; 1869, Cincinnati, John A. Logan, Illinois; 1870, Washington, John A. Logan, Illinois; 1871, Boston, A. E. Burnside, Rhode Island; 1872, Cleveland, A. E. Burnside, Rhode Island; 1873, New Haven, Charles Devens, Jr., Massachusetts; 1874, Harrisburg, Charles Devens, Jr., Massachusetts; 1875, Chicago, John F. Hartranft, Pennsylvania; 1876, Philadelphia, John F. Hartranft, Pennsylvania; 1877, Providence, J. C. Robinson, New York; 1878, Springfield, J. C. Robinson, New York; 1879, Albany, William Earnshaw, Ohio; 1880, Dayton, Louis Wagner, Pennsylvania; 1881, Indianapolis, George S. Merrill, Massachusetts; 1882, Baltimore, Paul van der Voort, Nebraska; 1883, Denver, Robert B. Beath, Pennsylvania; 1884, Minneapolis, John S. Kuntz, Ohio; 1885, Portland, Maine, S. S. Burdette, Washington; 1886, San Francisco, Lucius Fairchild, Wisconsin; 1887, St. Louis, John P. Rea, Minnesota; 1888, Columbus, Ohio, William Warner, Missouri; 1889, Milwaukee, Russell A. Alger, Michigan; 1890, Boston, Wheelock G. Veazey, Vermont; 1891, Detroit, John Palmer, New York; 1892, Washington, A. G. Weissert, Wisconsin; 1893, Indianapolis, John G. B. Adams, Massachusetts; 1894, Pittsburg, Thomas G. Lawler, Illinois; 1895, Louisville, Ivan N. Walker, Indiana; 1896, St. Paul, Thaddeus S. Clarkson, Nebraska; 1897, Buffalo, John P. S. Gobin, Pennsylvania; 1898, Cincinnati, James A. Sexton, Illinois; 1899, Philadelphia, W. C. Johnson, Ohio.

GRAND BANKS. See NEWFOUNDLAND, Vol. XVII, p. 382, note 384.

GRAND BAY OR HA-HA BAY, an inlet from the Saguenay river, Quebec, Canada, which receives the waters of the Ha-Ha river; a beautiful sheet of water, about a mile wide and 100 fath-

oms in depth, and is a source of attraction to summer tourists. See QUEBEC, Vol. XX, p. 165.

GRAND CANAL OF CHINA. See CHINA, Vol. V, pp. 631, 632.

GRANDEES (Span., *Grandes*), since the thirteenth century, the most highly privileged class of nobility in Castile, the members of the royal family being included. Their honors were hereditary. They held lands from the crown on the tenure of military service, were exempted from taxation, could not be summoned before any civil or criminal judge without a special warrant from the king, and could leave the kingdom and even enter the service of a foreign prince at war with Castile without incurring the penalties of treason. They had also the right of being covered in the presence of the king. In the national assemblies they sat immediately behind the prelates and before the titled nobility (*titulados*). Cardinal Ximenes did much toward lessening the power of the grandees, and later Charles V succeeded in reducing them, with the rest of the feudal nobility of Spain, to a dependent court nobility. Under Joseph Bonaparte, their privileges were entirely abolished, but they were partially regranted at the subsequent restoration. Grandees are still members of the Senate in their own right.

GRAND FALLS, a village and port of entry in Victoria County, New Brunswick, on the St. John River, and on the Canadian Pacific railroad, 93 miles N.N.W. of Fredericton. It is near the great falls of the river, which are 180 feet high, and very imposing. Steamers ply between here and St. John during high water. There is a fine suspension bridge over the river. Population 1891, 1,597.

GRAND FORKS, a city and the capital of Grand Forks County, northeastern North Dakota, on the Red River of the North (navigable from Fargo), and on the Great Northern and the Northern Pacific railroads. It contains the University of North Dakota, St. Bernard's Ursuline Academy and a Lutheran college. The region is an agricultural one, except where timbered. Lumbering and the manufacture of wooden articles form its chief industries. It is also the shipping and trading point for a large section. Population 1890, 4,979; 1900, 7,652.

GRAND HAVEN, a city, port and the capital of Ottawa County, western south Michigan, on Lake Michigan, and on the south bank of Grand River, and on the Chicago and West Michigan railroad, 31 miles W. by N. of Grand Rapids. It has a good harbor, with two lighthouses, and ships large quantities of lumber and grain. It contains several lumber-mills and manufactories of woodenwares, etc., and a magnetic spring renders the place a summer resort. Population 1900, 4,743.

GRAND ISLAND, a city, railroad junction and capital of Hall County, southeastern central Nebraska. It is on the north bank of the Platte River, opposite Grand Island, whence its name, and on the Burlington and Missouri River, the St. Joseph and Grand Island and the Union Pacific railroads. Shipping grain is the chief industry. Population 1890, 7,536; 1900, 7,554.

GRAND JUNCTION, a city and the capital of Mesa County, central western Colorado, on the

Denver and Rio Grande, the Colorado Midland, the Colorado, Wyoming and Great Northern and the Rio Grande Western railroads, at the confluence of the Grand and Gunnison rivers. The industries of the neighborhood are agriculture, horticulture, stock-raising and mining. Coal, limestone, sandstone, silver, gold, copper and asphalt are found. Population 1880, 859; 1890, 2,030; 1900 (12th census), 3,503.

GRAND JUNCTION, a town of Greene County, west-central Iowa, on the Chicago and Northwestern railroad, where it crosses the Des Moines and Fort Dodge railroad, 38 miles S. of Fort Dodge. The principal business in the vicinity is farming and stock-raising. Population 1900, 1,113.

GRAND JURY, a number of citizens of a judicial district summoned by the sheriff or other proper officer, to whom indictments are submitted against those charged with violations of the laws within their jurisdiction. The number of jurymen who are to be summoned on county grand juries is regulated by state statutes. Under the United States statutes, the grand juries which are called to attend the United States circuit and district courts consist of not fewer than sixteen nor more than twenty-three. The judge of the court selects a foreman from among their number. Grand juries selected under the state laws, and to attend the various state courts, are usually required to select their own foreman. The jurymen are sworn to perform their duties faithfully. Their proceedings are kept secret in every particular, so that those against whom indictments are found may not have opportunity to escape before arrest. They may call and examine witnesses, and are the sole judges of the testimony. Generally, twelve must concur before an indictment can be found, and upon indictment against any one, such person must be arrested and held for trial for the offense charged. See also JURY, Vol. XIII, pp. 785, 786.

GRAND OR CHETIMACHES LAKE, in Iberia, St. Martin's and St. Mary's parishes, Louisiana. It is about 35 miles long and 10 wide, and is too shallow for navigation. It is surrounded on all sides but the west by marshes and swamps, receives the waters of a number of rivers, and connects with the Gulf of Mexico by the Atchafalaya Bayou, 15 miles long. Two other lakes of this name in the same state are found in Pointe Coupee and Cameron counties.

GRAND LEDGE, a village of Eaton County, southern Michigan, on the Grand River, and on the Detroit, Lansing and Northern railroad, 12 miles W. of Lansing. It has a mineral spring, is a health-resort, and has good water-power, which is used for saw, cider, flour and other mills. Chairs, tables, terracotta and tiles are manufactured. In the vicinity are coal and fire-clay beds, and sandstone. Population 1890, 1,606; 1900, 2,161.

GRAND MAL, a form of epilepsy. See EPILEPSY, Vol. VIII, p. 479.

GRAND MANAN, an island in the Bay of Fundy, 22 miles long and from 3 to 6 wide, belonging to Charlotte County, New Brunswick. It is fertile, and has many good harbors. The chief settlement is Grand Harbor. The cod, herring and haddock

fisheries are important. The island is a summer resort. Population, 2,397.

GRAND PRÉ, a village lying in the basin of Minas, Kings County, western central Nova Scotia, 15 miles N.W. of Windsor. It is the opening scene of Longfellow's *Evangeline*. The village contains a seminary. The nearest post-office is Lower Horton. Population 1891, 700.

GRAND RAPIDS, a flourishing city, the capital of Kent County, west central Michigan. It is situated very favorably for commerce, being on ten railroad branches, and on the Grand River, at the head of navigation, and has an especially large distributing trade. Its streets are paved with asphalt and lighted with electricity, it has an electric street-railway system, reservoir water-works, 3 parks, 85 churches, 55 schools, a public library with 27,000 volumes, the City Home for the Treatment of Contagious Diseases, the Michigan Soldiers' Home, the State Masonic Home, St. John's Orphan Asylum and numerous hospitals. It is active in manufactures, the 1890 census reporting 869 industries, having a capital of \$16,000,000, employing 13,300 hands on an average, and paying \$6,500,000 in wages annually. The value of their products amounted to \$20,000,000. Of these industries, the most important are the chamber-furnishing, embracing 60 factories employing 16,000 men, and the carpet-sweeper and flour industries. The river, which falls 17 feet here in two miles, affords abundant water-power, which is much used. The gypsum-quarries near the city yield annually 100,000 barrels of stucco, and 100,000 tons of land-plaster. In 1891 the city limits were extended. Population 1880, 32,016; 1890, 60,278; 1900, 87,565. See also GRAND RAPIDS, Vol. XI, p. 47.

GRAND RAPIDS, a city and the capital of Wood County, central Wisconsin, on the Wisconsin River, and on the Green Bay, Winona and St. Paul railroad. Lumbering and agriculture are the chief occupations. There are lumber-mills, machine-shops and foundries in the city, and pure kaolin is found in the vicinity. Population 1900, 4,493.

GRAND RIVER, a river of Colorado and Utah, which rises, in several branches, in Grand County, central northern Colorado, on the west slope of the Front Range. Its direction is generally southwest, and it has two cañons of great beauty, one in Middle Park, in Colorado, where it has cut its way for three miles through granite rocks one thousand to fifteen hundred feet high; the other in Wayne and San Juan counties, where it is joined by the Green River to form the Colorado. Length, over 350 miles.

GRAND RIVER, a river of southwestern Michigan, rising in Jackson County. It flows north past Lansing, then takes a west-northwesterly course, and flows past Grand Rapids, after which it is navigable, from Grand Haven into Lake Michigan. Length, 250 miles.

GRAND RIVER, a river of northwestern Missouri, rising, in two branches, in Union County, southern Iowa, and flowing generally south-southwest, till it joins the Missouri, 20 miles above Glasgow. Length, about 220 miles.

GRANGE. See FARMERS' ORGANIZATIONS, in these Supplements.

GRANGER, GIDEON, an American lawyer; born in Suffield, Connecticut, July 19, 1767. He graduated at Yale in 1787, was admitted to the bar, and soon became prominent in his profession. He was a member of the legislature of Connecticut, and was instrumental in the establishment of the school fund; became Postmaster-General of the United States in 1801, and in 1819 was elected to the state senate. He died in Canandaigua, New York, Dec. 31, 1822.

GRANGER, GORDON, an American soldier; born in New York in 1821; graduated at the United States Military Academy in 1845; engaged in the Mexican War, and served at the beginning of the Civil War on the staffs of Generals McClellan and Sturgis; in September, 1861, appointed colonel of the Second Michigan Cavalry; in March, 1862, brigadier-general of volunteers, and put in command of the cavalry in the operations that led to the fall of Corinth; in command of the Fourth Army Corps at the battle of Missionary Ridge; of a division at Fort Gaines, Alabama, in 1864; and of the Thirteenth Army Corps in the Southwest, engaging in the siege of Fort Morgan, and in the operations that resulted in the fall of Mobile. He was brevetted first lieutenant and captain for services in the Mexican War, and for gallant conduct in the Civil War the brevets from major to that of major-general were conferred upon him. In January, 1866, he was mustered out of the volunteer service; in the following July was promoted to colonel, and was in command of the district of New Mexico at the time of his death, which occurred at Santa Fé, New Mexico, Jan. 10, 1876.

GRANGERS. See FARMERS' ORGANIZATIONS, in these Supplements.

GRANICUS, an historic river. See ASIA MINOR, Vol. II, p. 707.

GRANIER DE CASSAGNAC, BERNARD ADOLPHE DE, a French publicist and journalist; born at Bergelle, department of Gers, Aug. 12, 1808; educated at Toulouse; became a Parisian journalist under Berten and Girardin; defended romanticism in literature, and slavery in the West Indies, where he married; founded in Paris, in the interests of the Orleans dynasty, *Le Globe* newspaper, which assumed a turbulent character; supported the *coup d'état* of Louis Napoleon and his imperial system; began editing *Le Pays* in 1858, his son Paul joining him in 1866 in its direction; fled to Belgium after the capitulation at Sedan, but returned in 1871 to resume direction of *Le Pays*. He was a truculent adversary and duelist, wrote many books colored with bellicose prejudices, among them an account of a *Voyage to the Antilles*; histories of industrial and social agitations, of the Girondists, of the Directory, of the downfall of Louis Philippe, of phases of the second empire and of French democracy. He died in Paris, Jan. 31, 1880.

GRANIER DE CASSAGNAC, PAUL ADOLPHE DE, a French journalist and Deputy, son of Bernard; born in Paris, Dec. 2, 1843. He began journalism before he was of age, and adopted the

manners of a bravado, in insulting political opponents and then meeting them in duellistic combats, some of them notable for their ferocity and others for sensationalism. In 1866 he joined the staff of *Le Pays*, and later became editor-in-chief of the paper. He was an uncompromising Bonapartist, and in 1868 was decorated with the cross of the Legion of Honor by Napoleon III. When the Franco-Prussian war broke out, he enlisted as a volunteer and was taken prisoner at Sedan. Returning from a military prison in Silesia to Paris in 1872, he continued editing *Le Pays* until 1884, when he founded *L'Autorité*, and several times was prosecuted for fierce or seditious attacks upon the republican government. At the election of 1876 he was returned to the Chamber of Deputies from an arrondissement in the department of Gers, and in each subsequent election was rechosen to the same body. He was a supporter of the short-lived but fiery Boulangist movement, and the author of a few polemic books.

GRANITE FALLS, a village and the capital of Yellow Medicine County, southwestern Minnesota, on the Minnesota River, and on the Great Northern and the Chicago, Milwaukee and St. Paul railroads, 110 miles W. of Minneapolis. It is a shipping-point for agricultural produce, has flouring-mills and a foundry. Population 1900, 1,214.

GRANT, a city and the capital of Worth County, northwestern Missouri, 58 miles N.N.E. of St. Joseph, the terminus of a branch of the Chicago, Burlington and Quincy railroad. It ships the grain, live-stock and lumber produced in the vicinity. Population 1890, 1,186; 1900, 1,406.

GRANT, FORT, a United States army post in the Department of Colorado, situated in the town of Fort Grant, Graham County, southeastern Arizona. It has no railroad, but is connected by stage with Willcox, about 25 miles to the north, on the Southern Pacific railroad. Owing to its situation in a region which has long been exposed to attacks by hostile Apaches, Fort Grant is an important military post.

GRANT, SIR ALEXANDER, a Scotch educator; born in New York, Sept. 13, 1826; educated at Harrow, and Balliol College, Oxford; succeeded as baronet in 1856; appointed inspector of schools at Madras, India, in 1859; and became professor of history in Elphinstone College there, later its principal, and afterward vice-chancellor of Elgin College, Bombay; in 1868 principal of the University of Edinburgh, Scotland, continuing in that office till his death, Nov. 30, 1884. He published *The Story of the University of Edinburgh* (1883); *Xenophon*, in the Ancient Classics for English Readers; *Aristotle* (in the same series); and others.

GRANT, FREDERICK DENT, eldest son of General Grant, was born in St. Louis, Missouri, May 30, 1850. He graduated at West Point at the age of 21, and was assigned to the Fourth Cavalry. In 1871 he accompanied General Sherman to Europe. A year later he was detailed to command the military escort of the parties making the survey for the Southern Pacific railway. In 1873 he was assigned, with the rank of lieutenant-colonel, to the staff of General

Sherman, holding the position for eight years, when he resigned. In 1889 he was appointed by President Harrison United States minister to Austria, remaining till 1893. In 1895 he was selected as one of the police commissioners of New York City by the reform administration of Mayor Strong. Resigned July 30, 1897.

GRANT, GEORGE MUNRO, a Nova Scotian clergyman and author; born of Scotch parents at Stellarton, Dec. 22, 1835; educated at Pictou Academy and the West River Seminary of the Presbyterian Church; in 1853 won a scholarship, giving him a university course at Glasgow, Scotland, where he graduated with the highest honors in philosophy, and returned to Canada; in 1863 became pastor of St. Matthew's Church, Halifax; in 1877 principal of Queen's University, Kingston. He published works descriptive of Canada; among them *Ocean to Ocean through Canada* (1872); and *Picturesque Canada* (1881).

GRANT, JAMES, a British novelist; born in Edinburgh, Aug. 1, 1822. From the time he was 10 years old he lived with his father, an army officer, in various barracks in British America; in 1839 returned to England, and in the following year, retiring from the army, turned his attention to literature. His first work was *The Romance of War*, published in 1846, after which he brought out many novels of a similar character. His death occurred in London, May 5, 1887.

GRANT, JAMES AUGUSTUS, a Scotch soldier and explorer; born at Nairn in 1827; educated at Marischal College, Aberdeen; entered the Indian army in 1846 and served in several campaigns, participating in the relief of Lucknow. In 1863 he accompanied Captain Speke on his exploration of the source of the Nile, in the following year publishing, jointly with Captain Speke, an account of the trip, and in 1868 followed Lord Napier in his expedition into Abyssinia. He contributed to the journals of the Royal Geographical and Linnæan societies, and published *A Walk Across Africa* (1864) and *Khartoum as I Saw It* (1863). Died in Nairn, Feb. 11, 1892.

GRANT, SIR PATRICK, a Scotch soldier; born at Auchterblair, Strathspey, in Inverness, in 1804; at 16 entered the military service of the East India Company; fought in the Gwalior, Sutlej, and Punjab campaigns; in 1856 was made major-general and commander-in-chief of the army of Madras, and in the first days of the Mutiny, in 1857, acting commander-in-chief of Bengal; was made governor of Malta in 1867, and in 1874 governor of Chelsea hospital. In 1883 he was made field-marshal, and in 1885 colonel-in-chief of the Royal Horse Guards (the Blues). Died at Chelsea, March 28, 1895.

GRANT, ROBERT, an American lawyer and author; born in Boston, Jan. 24, 1852; graduated from Harvard University in 1873, and, six years later, finished a course at the Harvard Law School, and began the practice of law in Boston, and became judge of the probate court of Suffolk County, Massachusetts, in 1893. He contributed frequently to the magazines. His chief published works are *An Average Man* (1883); *Uncleared Bread* (1900); *The Little Tin God on Wheels* (1879); *The Knave of Hearts*

(1885); *The Reflections of a Married Man* (1892); and *The Opinions of a Philosopher* (1893).

GRANT, ULYSSES SIMPSON, an American soldier, and eighteenth President of the United States, was



GENERAL GRANT.

born at Point Pleasant, Clermont County, Ohio, April 27, 1822, being the eldest of the six children of Jesse R. Grant, an American of Scotch descent, and Hannah Simpson Grant, who were married in Clermont County, Ohio, in June, 1821. During his boyhood he worked on the farm and in the tannery of his father, attending regularly the schools of the neighborhood, and when 17 years old received an appointment to the United States Military Academy at West Point. In 1843 he graduated twenty-first in a class of 39, not being accounted especially proficient in any study except mathematics, and was given a brevet lieutenantship in the Fourth Infantry, stationed at Jefferson Barracks, Missouri. In 1845 he was commissioned second lieutenant, and joined the army of occupation in Mexico, under General Taylor. Later, his regiment was transferred to General Scott's army, where Grant served throughout the campaign, which terminated in the capture of the City of Mexico, winning two brevets by his gallantry. Returning to the United States with the army in 1848, he obtained a furlough and married Miss Julia Dent, the daughter of a St. Louis merchant. For the six years following he served at various posts, being raised in 1853 to the rank of captain. In the following year he retired from the army and followed farming near St. Louis, Missouri. Not finding this occupation very profitable, in 1860 he took a clerkship, at a small salary, in his father's leather business, at Galena, Illinois, where he remained till the outbreak of the Civil War. It is noteworthy that up to this time Grant had done nothing to merit or win particular distinction.

On April 15, 1861, President Lincoln called for volunteers, and four days later Grant began drilling a body of volunteers at Galena. He offered his services to the adjutant-general at Washington, and receiving no reply, accompanied his troops to Springfield, where he was employed by Governor Yates in the organization of volunteers. Five weeks later he was appointed colonel of the Twenty-first Illinois Infantry, and in August was commissioned brigadier-general of volunteers. On September 1st he was given command of the southeastern part of Missouri, with headquarters at Cairo, Illinois. Grant's policy was strategic, aggressive, and evidently clearly conceived from the first. It was to obtain possession of important points on the various confluent of the Mississippi and Ohio, traversing the central border states. On Sept. 5, 1861, he learned that a Confederate force was planning to take possession of Paducah, a little town at the junction of the Ohio and the Tennessee. On the

following day, without waiting for orders, Grant occupied the place. The move secured Kentucky to the Union. The legislature of the state, heretofore undecided, after this voted to remain loyal. November 1st, Grant was ordered to attack Belmont, which lay 18 miles down the Mississippi from Cairo, with the idea of frightening away General Price, who was advancing toward Missouri with a Confederate force. Grant's troops were raw, but he routed the garrison of the place, and, although almost surrounded at one time by a Confederate reinforcement, succeeded in cutting his way to his transports, and reached Cairo in safety. The engagement was not a victory, but it had its desired effect on General Price.

Grant's next move was up the Tennessee. For a long time he had importuned his superior, General Halleck, to allow him to capture Forts Henry and Donelson, and at last, on the 1st of February, 1862, permission to attempt the former capture was given. On the following day the expedition started. On the 4th, after a short bombardment by gunboats, the fort surrendered. Immediately, and without orders, Grant moved upon Fort Donelson, which was 12 miles to the northeast, on the Cumberland River. On the 12th he began the investment of the fortress with 15,000 men, a force later increased to 21,000, and eight batteries of artillery. The Confederate garrison numbered 21,000 and their position was strongly fortified. The fighting continued for three days, and on the 15th, after Grant had gained by assault a commanding position, the place was unconditionally surrendered. It was the first important military position won from the Confederates, and its possession gave the Unionists control of western Kentucky and Tennessee, besides opening navigation for hundreds of miles on the Mississippi, Tennessee and Cumberland. Moreover, it brought General Grant into notice and won for him a reputation as a strategist, although some of his superiors were slow in admitting his ability. He was soon made major-general of volunteers and given command of western Tennessee. Thinking to follow up his serious blow to the Confederate cause, General Grant started for Nashville on the 28th of February, again without orders. This time he was recalled by a dispatch from General Halleck, who had never been in sympathy with Grant's undertakings, relieving him of his command and ordering him to remain at Fort Henry. The matter, however, was reconsidered, and Grant replaced in his former position.

He now concentrated his forces, which numbered 38,000 men, near Shiloh, at Pittsburg Landing, on the west bank of the Tennessee River, and awaited, as he was ordered, a reinforcement of 40,000 men under General Buell. But on the 6th of April, Gen. A. S. Johnston, with a Confederate force of 50,000 men, attacked Grant in front, and with superior numbers succeeded in pushing the Union troops steadily backward toward the river. At night Grant was joined by Buell. On the following day a vigorous attack was made on the Confederate army, which was forced to retreat to Corinth, 19 miles away. Halleck now took command of the army and advanced on Corinth, which he found evacuated

when he was ready to deliver an assault. By the appointment of Halleck as general-in-chief, and his consequent removal to Washington, Grant was again in command of the army of Tennessee. He fought an indecisive battle at Iuka, fortified Corinth, and, when the Confederates attacked the place on the 3d and 4th of October, 1862, repulsed them with great loss. Immediately after this, Grant determined upon the capture of Vicksburg, and on November 2d began moving into Mississippi from the north, Sherman being sent down the Mississippi River with 40,000 men to attack the city from the Yazoo River. The campaign, however, failed, on account of the cowardice of one of Grant's subordinate officers, who surrendered the general's contemplated base of supplies, and on account of Sherman's repulse. In January, 1863, Grant brought his troops together on the west bank of the Mississippi, opposite the mouth of the Yazoo, taking command of them in person. The only favorable point of attack upon Vicksburg seemed to be the high land east of the city, and, after wasting several months in fruitless attempts to collect his forces there, Grant put into execution a bold and brilliant plan, contemplated for some time. The army was marched through the swamps on the western side of the river, while the transports and Commodore Porter's auxiliary fleet of gunboats ran past the Confederate batteries. With the fleet he ferried his army across the Mississippi, thirty miles below Vicksburg, uncovering Grand Gulf. He was now threatened by two Confederate armies, one under Pemberton and the other under Joseph E. Johnston, and these he met and defeated separately. On the 23d of May, 1863, the siege of Vicksburg began, which lasted until July 4th, when the place surrendered and the garrison of 32,000 men was paroled.

Grant was now made major-general in the regular army and placed in command of the military division of the Mississippi. His next great campaign was for the relief of Chattanooga, where the beaten and baffled army of the Cumberland was beleaguered and reduced to deplorable destitution and impotence, being cut off from supplies and almost surrounded by the enemy. On Oct. 23, 1863, Grant reached the place, and at Wauhatchie, on the 29th, was victorious in an engagement which opened Chattanooga to reinforcements and supplies. On November 23d to 25th the battle of Chattanooga was fought, and the Confederates were swept from Look-out Mountain, out of the valley, and from the crest of Missionary Ridge, in full retreat, into Georgia. On the 9th of March, 1864, the rank of lieutenant-general was conferred upon Grant, and three days later was put in command of all the Union forces.

His operations were now on a larger scale. There remained General Lee, with the Confederate army of northern Virginia, to be disposed of. Against him, General Grant took command of the main division of the Union forces in person; Sigel, who was sent into the valley of Virginia, was defeated, and succeeded by Hunter, and he in turn was succeeded by Sheridan, whose campaign thereafter was a series of victories; Sherman was directed to pene-

trate Georgia, and after reaching Atlanta was sent on his famous march to the sea; a third army was sent against Richmond, under Butler. In the mean time, Grant was pushing Lee back toward the James River, and slowly but surely reducing his military strength. The battles of the Wilderness, Spottsylvania, North Anna and Cold Harbor each resulted in an advance of the army of the Potomac. Grant's losses were enormous, but he claimed that the field of battle was more merciful than the typhus of camps, and that the losses of Lee's army were irreparable. To destroy his power of resistance brought the end of slaughter nearer. Owing to the outgeneraling of Butler, who was "bottled up" at Bermuda Hundred, Grant had to cross the James below Richmond to relieve and join him, and this made it necessary to include Petersburg in the sieges that ended the war. This campaign from the Rapidan to Appomattox lasted from the 4th of May, 1864, to the 9th of April, 1865. On the night of the 2d of April, Richmond was evacuated, and Lee began a retreat toward Lynchburg, but finally, on April 9th, at Appomattox Courthouse, surrendered to Grant. This event was decisive, and resistance to the authority of the Union rapidly ceased, and all Confederate forces capitulated. The strictly military but magnanimous terms offered by Grant to Lee went far to reconcile the South to her defeat. For further details of Grant's military history, see UNITED STATES, Vol. XXIII, pp. 778-783.

On April 10, 1865, Grant returned to Washington, and on the 14th Lincoln was assassinated, making Andrew Johnson President. At first, Johnson professed to be implacable toward the leaders of secession; later, he became quite as ardent in a scheme to reinvest them with their *ante-bellum* rights in the government. In both cases he came into conflict with Grant. An indictment of General Lee for treason was procured in the Virginia circuit court of the United States. The President was resolute to proceed with the prosecution. Lee appealed to Grant, who thereupon insisted that the men whose paroles had been given at Appomattox, and after that time under the same terms, could not be tried for treason while they kept them, and he threatened to resign if full faith with the paroled was not observed. The prosecutions were given up, but when Johnson, in the matter of reconstruction, completely changed his policy, it was due to Grant that the peace of the country was preserved. Contemplating the exercise of powers which Grant believed to be a usurpation of the rights of Congress, and in which he might need the control of the army, the President ordered Grant on an errand to Mexico. The General claimed that the order was beyond the authority of the President, nor would he leave Washington on any pretext the President invented, a position in which Congress sustained him by appropriate legislation. It even went so far as make all orders issued by district commanders, although done by direction of the President, subject to the approval of the general of the army, thus practically wresting from the executive the control of the military forces. In August, 1867, Johnson suspended Stanton as Secretary of War, and placed

Grant in charge, pending the determination of the President's right to remove from office without the consent of the Senate. The Senate did not approve of Stanton's removal, and Grant retired from the War Department and sided with Congress. When directly asked if he would obey orders in case the President should recognize the Senators and Representatives chosen in the Southern states, and should need the army to seat them in Congress, Grant told him that such a use of force would not be lawful, and he would maintain his honor and duty. The position was one of delicacy and great peril to the country, for in the contest between Congress and the executive, Grant had to judge how far the orders of his superior were lawful. Owing to his sagacity, love of order and patriotism, the crisis was passed safely, notwithstanding the bitterness of the contention, and it was Grant's conduct that designated him for the candidacy of the Republican party for the Presidential chair, although he had never voted the ticket of that party.

The national Republican convention of 1868, held in Chicago, nominated him for the Presidency on the first ballot, and he was elected by a large majority. Grant's career as President cannot be said to have been brilliant. He was a soldier, and had a soldier's directness and honesty, while to political arts and chicanery he was a stranger. He strove to put the civil service on a meritorious basis, but the politicians would not sustain him, and he abandoned the effort. During his first administration the *Alabama* claims were settled with Great Britain. He also sent commissioners to Santo Domingo in 1871-72, who reported that annexation to the United States was desired there, and he urged the acquisition of that state, but his policy was resisted in the Senate. His popularity secured him a re-election in 1872, against Horace Greeley, who was nominated by the Democrats and the Liberal Republicans, the issues being the stringency of the Reconstruction Acts, the military occupation of the Southern states, and corruption in administration. During his second term there were many frauds perpetrated on the government, such as the whisky and star-route rings. His Secretary of War resigned to escape impeachment for peculation. But no one believed the President in any way implicated in these dishonest schemes. It was felt that his own trustfulness and loyalty to men in whom he confided made him an easier victim of artful and unscrupulous schemers. Meanwhile, reconstruction had been steadily carried on in the South, amicable relations established with England, and several reforms started which bore fruit in later years. For his administrative career, see UNITED STATES, Vol. XXIII, pp. 785, 786.

After retiring from the Presidency, General Grant made a tour around the world, and was received at foreign courts with honors reserved for sovereigns. In 1880 his name was presented at the national Republican convention for the Presidency, but his nomination was defeated, partly on account of the feeling against a third term and partly because of dislike for the arrogance of the men who urged it in order to defeat the aspirations of Blaine.

In 1881 Grant removed to New York, and later

became a partner in a banking establishment in that city. The firm failed soon after, on account of the frauds of the junior partner, leaving Grant a bankrupt. He surrendered to his principal creditor his medals, swords, trophies and presents from foreign governments, who gave them to the United States; they are preserved at Washington. In 1885 he was restored to the rank and pay of general, and placed on the retired list. He commenced, in the *Century*, a series of articles on the battles of the war, which, later, he amplified into his *Personal Memoirs*. These memoirs were completed during the months of pain while Grant was dying of cancer in the mouth, and the royalties from the sale greatly enriched his family. He died at Mount McGregor, near Saratoga, New York, whither he had gone as to a sanatorium, July 23, 1885, and was buried in Riverside Park, in New York City, with a pageantry and honors unexampled in America. By special act of Congress, after his death, a yearly pension of \$5,000 was granted to his widow.\*

On April 27, 1897, amid impressive ceremonies which included a military parade and naval demonstration, General Horace Porter, President of the Grant Monument Association, transferred to Mayor Strong, acting in behalf of New York City, the custody of the mausoleum in Riverside Park.

The beautiful memorial pile of white granite, 150 ft. in height, stands 100 ft. above mean high water of the Hudson (see cut p. 2203). The first 72 ft. of the structure is a cube of the Doric order surmounted by a parapet bearing the sculptured figures of Peace and War. Above this is a cupola 70 ft. in diameter encircled by relieving Ionic columns. Side stairways lead to the crypt where rests the sarcophagus of brilliant red porphyry.

GRANT'S PASS, a town and the capital of Josephine County, southwestern Oregon, on the Rogue River, and on the Southern Pacific railroad. It is the trading and shipping point of a large agricultural, mining and lumber region. Population 1890, 1,432.

GRANULAR LIDS OR GRANULAR CONJUNCTIVITIS. See OPHTHALMOLOGY, Vol. XVII, p. 780.

GRANVILLE, a village of Washington County, central eastern New York, on the Delaware and Hudson railroad, 22 miles E. of the head of Lake George. Gun-sights, axes and farming implements are manufactured. It is in a township of the same name, which includes five other villages. Slate is quarried in abundance, and roofing-slate and marbled slate articles are made. Population of village, 2,149; 1900, 2,700.

GRANVILLE, a village of Licking County, central Ohio, on the Toledo and Ohio Central railroad, seven miles W. of Newark. It is the seat of Denison (Baptist) University, the Shepardson College for Women and the Granville Female College, and has several manufacturing establishments. Population 1890, 1,366; 1900, 1,425.

\* For a more extended biography, the reader is referred to the following: *Personal Memoirs of U. S. Grant*, written by himself (2 vols., 1885-86); *Military History of Ulysses S. Grant*, by Adam Badeau (3 vols., New York, 1867-81); *Life and Public Services of General U. S. Grant*, by James Grant Wilson (1868); *The Ancestry of General Grant, and Their Contemporaries*, by Edward C. Marshall (1869); and *Around the World with General Grant*, by John Russell Young (1880).



**GRANVILLE, GRANVILLE GEORGE LEVESON-GOWER, EARL OF, an English Liberal;** born May 11,



EARL GRANVILLE.

1815, in London; educated at Eton and Christ Church, Oxford, and in 1835 went as attaché to his father's embassy to Paris; in 1836, entered Parliament for Morpeth; four years later sat for Lichfield; in 1846, succeeded his father in the title; in 1851 became Secretary of Foreign Affairs, and after that time held office in every Liberal government until his death, leading his party in the House of Lords; president of the Privy Council (1855-58, 1859-66); Colonial Secretary (1868-70); Secretary of Foreign Affairs in (1870-74, 1880-85); in Gladstone's Cabinet of 1886 was Secretary of State for the Colonies. He died in London, March 31, 1891.

**GRAPE.** See **HORTICULTURE**, Vol. XII, pp. 277, 278; **VINE**, Vol. XXIV, 237, 238; **WINE**, Vol. XXIV, pp. 601, 611; and **VITICULTURE**, in these Supplements.

**GRAPE SUGAR.** See **GLUCOSE**, Vol. X, p. 695, **SUGAR**, Vol. XXII, p. 623, and **GLUCOSE** in these Supplements.

**GRAPHIC STATICS.** See **MECHANICS**, Vol. XV, pp. 725, 726.

**GRAPPLE-PLANT** (*Uncaria procumbens*), a procumbent plant of the same genus with the Gambir, a native of South Africa. The seed-vessel has many hooked thorns, and clings most tenaciously to any animal—a provision for the distribution of the seed. When it lays hold of the mouth of an ox, Livingstone says the animal stands and roars with pain and a sense of helplessness.

**GRAPTOLITES**, a genus of cœlenterates of the hydroid class, found as fossils in the slates of the Lower Silurian. The name, signifying written-stone, refers to the appearance of the slates with the fossils. They are allied to the existing sertularians, but, unlike them, were not attached to foreign objects.

**GRASS-CLOTH**, a popular and erroneous name for several textiles made from fibers of various plants, none of which are grasses. See **RHEA FIBRE**, Vol. XX, pp. 506, 507.

**GRASSE, JOHANN GEORG THEODOR**, a German bibliographer; born at Grimma, Jan. 31, 1814; studied philology and the history of literature at Leipsic and Halle; taught in the Kreuz schule in Dresden; in 1843 made librarian of King Friedrich-August II of Saxony; later inspector of the Cabinet of Coins and Medals and director of the "Green Vaults," with their celebrated collections of jewels, gold, silver and curios; from 1837 to 1860, published a work entitled *Lehrbuch einer Allgemeinen Literaturgeschichte aller Bekannten Völker der Welt*, a great mass of bibliographical material, of which his work, *Handbuch*, is a compendium. He also studied the myths and legends of the middle ages, and wrote several books on these subjects, besides treatises on

hunting, beer, porcelain, ancient coins, surnames and Christian names, Latin names, etc., and in 1876 a popular history of Saxony. He died in Dresden, Aug. 27, 1885.

**GRASSE, FRANÇOIS JOSEPH PAUL, COMTE DE**, a French admiral; born at Valette, Provence, in 1723; first served in the navy of the Knights of Malta in 1734, against the Turks; in 1749 passed into the service of France; while in charge of a convoy to the East Indies, was captured by a British admiral and imprisoned in England for two years; in 1762 became a captain; in 1778 was made a rear-admiral; in March, 1781, De Grasse set out from Brest with a large fleet conveying a land force to the United States; in June he assisted at the taking of Tobago, and then sailed to the mouth of the Chesapeake, in order to assist in the operations against Lord Cornwallis, who, shut up in Yorktown, was obliged to surrender, Oct. 19, 1781. De Grasse received the thanks of Congress for his share in this decisive victory. In January, 1782, he captured from the British the island of St. Christopher, in the West Indies, but on April 12th of the same year, after a gallant fight with Rodney, De Grasse was taken prisoner and conveyed to London, where he assisted in the negotiations relating to the peace of 1783, by which the independence of the United States was acknowledged. He was suspected of treachery by the French, but upon his return to France an official investigation of his conduct resulted in an honorable acquittal. Before his death the title of lieutenant-general of naval forces was conferred upon him. He died in Paris, Jan. 11, 1788.

**GRASSES.** See **FORAGE PLANTS IN THE UNITED STATES**, in these Supplements.

**GRASSHOPPER CREEK OR DELAWARE RIVER.** See **DELAWARE RIVER**, in these Supplements.

**GRASSMANN, HERMANN GÜNTHER**, a German mathematician and philologist; born at Stettin, Prussia, April 15, 1809; instructor in Stettin from 1834 to 1852, then professor of mathematics in the gymnasium at Stettin. He published a translation and dictionary of the Rigveda and other philological works, also treatises on mathematics, the chief of which, on the *Science of Extension*, comprised a system of geometry similar to Sir W. R. Hamilton's system of quaternions. In 1862 he published, in *Kuhn's Zeitschrift*, a phonetic law, since called Grassmann's law, by which, in Sanskrit and Greek, an aspirate loses, by dissimilation, its after-breath when an aspirate stands at the beginning of the next syllable. He died in Stettin, Sept. 26, 1877. See **QUATERNIONS**, Vol. XX, p. 163.

**GRASSMANN, ROBERT**, a German writer, brother of Hermann G.; born at Stettin, Prussia, March 8, 1815; took a university course and began teaching; in 1848 commenced writing for the press and produced many works in the field of science and philosophy. Among them are *Die Wissenschaft oder Physik; Die Formenlehre oder Mathematik*; and others on biology, metaphysics and philosophy.

**GRASS-MOTH**, a name usually given to moths of the genus *Crambus*, but sometimes to its allies.

This genus is common in all countries. Certain species are abundant in meadows and pastures in the United States. The caterpillars feed on the grasses, and when numerous sometimes do much damage.

GRASS OF PARNASSUS, the common name of *Parnassia*, a genus of plants belonging to the family *Saxifragaceæ*. It is a native of bogs and moist heaths in the northern parts of both hemispheres, becoming a mountain plant farther south. It is characterized by its scape-like stem, bearing a solitary white flower, and its cluster of gland-tipped sterile filaments standing before each veiny petal. *P. Caroliniana* is the common North American species.

GRASS-OIL, a fragrant volatile oil obtained largely from different grasses of the genus *Andropogon*, indigenous in India. It is used in medicine, the perfuming of soap and as an adulterant for more expensive perfumeries. The precious spikenard-oil of the Scriptures is supposed to have been obtained from one species. The kind known as the grass-oil of Naur is produced at the foot of the Vindhya Hills and exported from Bombay. The term is used rather loosely to cover a number of distillations from this genus, called, according to the species of the grass or the locality where the oil is produced or used, oil of lemon-grass, oil of ginger-grass, oil of geranium, and similar names, frequently erroneous. Ceylon exports ten tons of this oil annually.

GRASS TREE, the common name of *Xanthorrhæa*, a genus of plants of the family *Liliaceæ*, natives of Australia. They have shrubby stems, with tufts of long, wiry foliage at the summit, and a long cylindrical spike of densely aggregated flowers shooting up from the center of the tuft of leaves. The base of the inner leaves of some species is edible. All the species abound in a resinous juice, which, on exposure to the air, hardens into a reddish-yellow inodorous substance, soluble in alcohol, and useful as a tonic in dysentery, diarrhœa, etc. The common grass tree (*X. hastilis*), which yields gum for varnish, has a stem about four feet high, but sometimes a foot in diameter. It is of extremely slow growth. Several species are found in Eastern Australia and also in New Zealand. The genus also is called "black-boy."

GRASS VALLEY, a post town of Nevada County, northwestern California, on the Nevada County Narrow Gauge railroad, which connects with the Southern Pacific. It contains two orphan asylums, several schools, foundries and quartz-mills. This place is the center of the chief gold quartz-mining district of California. Pop. 1890, 4,032; 1900, 4,719.

GRASS-WRACK, the common name of *Zostera*, a genus of plants of the family *Naiadaceæ*. The leaves are narrow and grass-like, and the flowers are hidden in their upper sheaths. The common grass-wrack (*Z. marina*), or eel-grass, is a perennial plant which forms green meadows on the bottom of shallow bays. It becomes white by exposure to air. The rush-like coverings of Italian liquor-flasks are made of it, and it is used for packing glass bottles. The plant is now an article of commerce under the name of *Alga marina*.

GRATIOLA, a genus of plants of the family *Scrophulariaceæ*. *G. officinalis*, sometimes called hedge-hyssop, is found in pastures in most parts of Europe. It is extremely bitter, acts violently as a purgative, diuretic and emetic, and in overdoses is an acrid poison. Formerly it was esteemed so highly as a medicine that the name of *gratia Dei* ("grace of God") was given to it, and for the same reason it is known as *herbe au pauvre homme* ("poor man's herb"). *G. Peruviana*, a South American species, has somewhat similar properties. These properties are supposed to depend upon a resinous principle called *Gratiolin*. Several species are natives of the United States, all of them being inconspicuous plants in low or wet places.

GRATIOT, CHARLES, an American soldier; born in Missouri in 1788. In 1806 he graduated from West Point, and entered the army as second lieutenant of engineers; made captain in 1808, and served in the War of 1812 as chief engineer of Harrison's army; in 1815 promoted to major; in 1819 to lieutenant-colonel, and in 1828 to colonel, and put in charge of the engineering bureau at Washington, with the brevet of brigadier-general; later in the same year, appointed inspector of West Point, which position he held until dismissed by the President, Dec. 6, 1838, on the charge of misappropriation of public funds. He appealed to the United States Senate to investigate his case, but the matter was never settled. From 1840 to 1855 he held a clerkship in the land-office at Washington, then went to St. Louis, where he died in poverty, May 18, 1855.

GRATRY, AUGUSTE JOSEPH ALPHONSE, a French theologian and author; born at Lille, March 30, 1805. After being educated at the École Polytechnique he became an ecclesiastic, and in 1841 was appointed director of the Collège Sainte-Barbe, Paris; in 1846 chaplain of the Normal School, Paris; in 1852 joined the Abbé Petetot in reorganizing the order of the Oratorians of the Immaculate Conception, having previously resigned his position in the Normal School. In 1861 Bishop Dupanloup appointed him vicar-general of Orleans, and in 1863 he was made professor of moral theology at the Sorbonne, Paris; in 1867 chosen to the Academy; in 1869 left the Oratorians on account of being censured for his connection with Père Hyacinthe and the League of Peace. He published, among other works, *La Connaissance de Dieu* (1855); *Logique* (1856); *La Morale et la Loi de l'Histoire* (1868). Several of his writings were directed against Renan and his school. He died in Montreux, Switzerland, Feb. 6, 1872.

GRATTAN, THOMAS COLLEY, a British author; born in Dublin, Ireland, in 1796; studied law in Dublin, but afterward devoted himself to literature. In 1828 he went to Belgium and settled in Brussels, where he actively supported the pretensions of King Leopold to the throne of Belgium; British consul at Boston in 1830-53; and subsequently held an office in the Queen's household. He published a pamphlet on the boundary question between Great Britain and the United States, and an attack on American society and institutions, entitled *Civilized America* (2 vols., 1859). He also published *England*

and the *Disrupted States of America* (1861). He died in London, England, July 4, 1864.

GRAVEL, a disease of the kidneys. See *Calculi*, under VESICAL DISEASES, Vol. XXIV, p. 189.

GRAVEL, sedimentary material. See GEOLOGY, Vol. X, p. 236.

GRAVELOTTE, BATTLE OF, called also REZONVILLE, and by the French ST. PRIVAT, the bloodiest and the greatest conflict of the Franco-Prussian war. The Emperor had yielded the position of commander-in-chief of the French forces to Marshal Bazaine. On August 16th, Bazaine, who had concentrated the army around Metz, in Lorraine, gave orders for a retreat toward Verdun; but, in the mean time, the German armies, by a circuitous march, had crossed the Moselle south of Metz, and were marching northwest to cut off the French retreat. The First Corps of German met the French at Vionville on the 16th, the result of the action being indecisive except that it prevented Bazaine's purposed retreat. On the following day he returned to the heights which extended west of Metz from St. Privat to Rozerieulles and faced his army to the west. The King of Prussia arrived on the same day at Gorze, and prepared for battle on the following day. The Germans were now east of the French. For a time King William was in doubt whether the French would try to march to the north or hold their position. On the 18th it was learned that they had not moved. Thereupon the order was given for the Germans to make a circuitous march to the right. The right wing of the German army attacked the French first in front, next the center, while the left wing closed in from the north. It was here that the severest fight took place, resulting in the capture of St. Privat by the Germans at seven p.m. The battle was decided some time later by the failure of the French left to break through the German line at Gravelotte. The German army numbered 211,000 men, and lost 28,000; the French numbered 140,000, and sustained a loss of 12,000. The result of the battle was that Bazaine was forced to retreat into the fortress of Metz, which he finally surrendered, with his whole army, to Prince Frederick Charles.

GRAVESANDE OR 'S GRAVESANDE, WILLEM JAKOB VAN, a Dutch philosopher and mathematician; born at 'S Hertogenbosch, Netherlands, Sept. 27, 1688; he studied law and philosophy at Leyden and Leipsic, and was professor of mathematics and astronomy at Leyden, and between the years 1717 and 1734, and after that time until his death, professor of philosophy at the same university. In association with MUSSCHENBROEK (see Vol. XVII, p. 109), he introduced the Newtonian philosophy into Holland, and contributed powerfully to shake the hold of Descartes upon the schools. Among other works he wrote a treatise on physics and an *Introduction to Philosophy*. He died at Leyden, Feb. 28, 1742.

GRAVES'S DISEASE OR EXOPHTHALMIC GOITER. See GOITRE, Vol. X, p. 740.

GRAVING—DOCKS. See HARBOURS, Vol. XI, p. 469.

GRAVITIES, SPECIFIC, the relative densities of bodies. See HYDROMETER, Vol. XII, pp. 536-542.

GRAY, ALBERT ZABRISKIE, an American clergyman; born in New York City, March 2, 1840; graduated at the University of New York in 1860, and at the General Theological Seminary of the Protestant Episcopal Church, in New York, in 1864. He served as chaplain of the Fourth Massachusetts Cavalry during the Civil War, and in 1882 was elected warden of Racine College, Wisconsin. He was engaged in the work of church reform in Europe, and was a delegate to the general convention in 1886. Among his writings are *The Law and the Life* (1876); *Mexico As It Is* (1878); *Words of the Cross* (1880); and *Jesus Only, and Other Sacred Songs* (1882). He died Feb. 16, 1889.

GRAY, ASA, an American botanist; born in Paris, Oneida County, New York, Nov. 18, 1810. In 1831 he graduated at Fairfield College of Physicians and Surgeons, in Herkimer County, New York, and engaged in teaching chemistry and natural history in a school at Utica, New York, until 1833, when Dr. John Torrey gave him an appointment as his assistant at the College of Physicians and Surgeons, in New York City. He began at once to assist Dr. John Torrey on a serial



ASA GRAY.

work, the *Flora of North America*, the first installment of which appeared in 1838. The first volume was issued in 1840, the work remaining uncompleted. This early work turned Gray's attention to the subject of botany as a permanent study. In 1834 he was appointed to the Wilkes expedition to South America and the islands of the South Pacific, but finally declined the appointment, although he prepared the *Botany of the Wilkes Expedition* from the notes and specimens brought to him. In 1837 he accepted a chair in the University of Michigan, but first went to Europe for a year's study. The Fisher professorship of natural history being founded at Harvard in 1842, Gray became its first incumbent. Here he remained in active service until 1873, during which time he superintended the formation of the most important herbarium in the country. In 1874 he succeeded Agassiz as regent of the Smithsonian Institution; in 1878 was elected a member of the Academy of Sciences in the Institute of France. The last fifteen years of his life were passed in study and investigation at Cambridge. Gray claimed to be a theistic evolutionist. While accepting the modern theory of evolution as enunciated in Darwin's *Origin of Species*, he did not reject the essential tenets of the Christian faith. He was an active supporter, correspondent and friend of Darwin, furnished him some data from his own researches, and wrote critical essays upon his works, later collected under the name of *Darwiniana*. Among others of his works are *Genera of Plants of the United States* (1848-49); *Manual of the Botany of the Northern United States*, which has become the standard textbook; *How Plants Grow*; *Relations of the Japanese*

*Flora to Those of North America*, which made his reputation abroad; and his most important work, the unfinished *Synoptical Flora*, the completion of which was undertaken by Harvard College. He was on the editorial staff of the *American Journal of Science and Arts* for 35 years. His *Life and Letters* have been recently published by his wife, the correspondence with Darwin, covering the period of the Civil War, being of rare interest. Dr. Gray made a specialty of the vast and difficult order *Compositæ*, his analysis and classification of which display a knowledge unrivaled among botanists. He died in Cambridge, Massachusetts, Jan. 30, 1888. In memory of him, Gray's Peak, in the Rocky Mountains, received its name.

GRAY, ELISHA, an American inventor; born at Barnesville, Ohio, Aug. 2, 1835. He served apprenticeships at blacksmithing, carpentry and boat-building; then studied physical science at Oberlin College, supporting himself by working as a carpenter. His patents number about fifty, a large number of which relate to the telephone, and the remainder to telegraphic apparatus, among them a speaking-telephone, and a multiplex telegraph by which eight messages can be sent at one time over one wire. In 1893 he announced his invention of the telautograph, by which autograph messages may be transmitted by electricity. See TELEGRAPH, Vol. XXIII, p. 124.

GRAY, HENRY PETERS, an American artist; born in New York City, June 23, 1819; studied art with Daniel Huntington; in 1839 went to Europe for four years; from 1869 to 1871 president of the National Academy, and then spent three years in Florence. His subjects were largely historical and classical, but he painted over three hundred portraits. He died in New York City, Nov. 12, 1877.

GRAY, HORACE, an American jurist; born in Boston, Massachusetts, in 1829; graduated at Harvard in 1845, and later at the Harvard Law School; became a lawyer in 1851; and, in succession, reporter, in 1864 associate justice, and in 1873 chief justice of the supreme court of the state. In 1881 he was made associate justice of the United States supreme court.

GRAY, ISAAC PUSEY, an American politician; born in Chester County, Pennsylvania, Oct. 18, 1828; studied law; and entered mercantile business; in 1855 moved to Union City, Indiana; during the Civil War was colonel of the Fourth Indiana Cavalry. In politics he was first a Whig, then a Republican, and from 1871 a Democrat. In 1868 he was elected state senator; in 1876 made lieutenant-governor; in 1884 governor; and in 1892 appointed minister to Mexico. He died in Mexico, Feb. 14, 1895.

GRAY, ROBERT, an American navigator; born at Tiverton, Rhode Island, in 1755. In September, 1787, he sailed from Boston in command of the sloop *Washington*, for the purpose of trading with the natives of the northwest coast of America, and returned in 1790 by way of Canton, China, thus being the first to carry the American flag around the globe. Upon a second voyage, in 1792, to the same region, he discovered the Columbia River,

naming it after his vessel. He died in Charleston, South Carolina, in 1806.

GRAYBACK OR KNOT. See SANDPIPER, Vol. XXI, p. 260; and KNOT, Vol. XIV, p. 129.

GRAYDON, ALEXANDER, an American soldier and author; born in Bristol, Pennsylvania, April 10, 1752; was educated in Philadelphia and studied law; in 1775 received the appointment of captain, and engaged in raising recruits; was in the battle of Long Island, and was taken prisoner in a subsequent action; exchanged in 1778, but did not rejoin the army; was prothonotary of Dauphin County, Pennsylvania, from 1785 to 1799. He resided for some years near Harrisburg, and removed to Philadelphia in 1816. He was a contributor to literary and political journals, and published *Memoirs of a Life Chiefly Passed in Pennsylvania Within the Last Sixty Years* (1811), reprinted in London and Edinburgh. He died in Philadelphia, May 2, 1818.

GRAY DUCK. See GADWALL, in these Supplements.

GRAY FRIARS. See FRANCISCANS; Vol. IX, pp. 698-700.

GRAYLING, a town and the capital of Crawford County, central northern South Michigan, 45 miles E. of Traverse City, situated on the Au Sable River, and on the Mackinaw division of the Michigan Central railroad. It is surrounded by pine forests, and its principal business is lumbering and sawing, for which it has several mills and good water-power. Grayling fish is found in abundance near here. Population township 1900, 1,716.

GRAY'S PEAK, in Summit and Clear Creek counties, northern central Colorado, 12 miles W. of Georgetown. It is the twin of Torrey's Peak and of the same height, 14,466 feet. It was named in honor of Dr. Asa Gray.

GRAYVILLE, a town of White County, southeastern Illinois, situated on the Wabash River, at the mouth of the Bonpas River, and on the Cleveland, Cincinnati, Chicago and St. Louis and the Peoria, Decatur and Evansville railroads. The surrounding country is fertile, and considerable grain is shipped. It has stave and heading factories, and flour, saw and planing mills. Population 1890, 1,999; 1900, 1,948.

GRAYWACKE OR GREYWACKE, in geology, a sort of conglomerate rock, found chiefly in the Palæozoic series. See GEOLOGY, Vol. X, p. 237.

GREASE. See VACCINATION, Vol. XXIV, pp. 23, 24.

GREASE-WOOD, a name applied to various chenopodiaceous shrubs growing abundantly in saline localities in the western United States. The one most commonly referred to as grease-wood is *Sarcobatus vermiculatus*, a rigid, wide-branching, leafy shrub, with smooth white bark, and terminal staminate spikes with persistent spirally arranged scales.

GREAT BARRINGTON, a village of Berkshire County, western Massachusetts, beautifully situated on the Housatonic River, and on the New York, New Haven and Hartford railroad, 15 miles S. of Lenox, and noted as a summer resort. It was the county seat until 1787, and the scene of great excitement during the suppression of Shay's Rebel-

lion. It has manufactories of woollens, cotton goods, paper and brick, and in the vicinity are noted quarries of variegated marble. It is the seat of the Sedgwick Institute (a Princeton preparatory school) and Housatonic Hall, a school for girls. Population 1890, 4,612; 1900, 5,854.

GREAT BASIN. See UNITED STATES, Vol. XXIII, pp. 794, 795.

GREAT BEAR LAKE. See BEAR LAKE, GREAT, Vol. III, p. 462.

GREAT BEND, a city and the capital of Barton County, central Kansas, on the Arkansas River, at its most northern point in the state, on the Santa Fé and the Missouri Pacific railroads; seat of Central Normal College. It has salt-mines, and stone-quarries and large agricultural interests. Population 1900, 2,470.

GREAT BRITAIN AND IRELAND, UNITED KINGDOM OF. For elaborate articles on the geography, history, government, literature and earlier statistics of Great Britain and the British Empire, see in this ENCYCLOPÆDIA and its Supplements, the titles of the countries, severally, which together constitute the present British Empire.

The article on ENGLAND, Vol. VIII, p. 368, ends with the accession to power of Disraeli in 1874. Many, varied and important have been the events of English history since that date. It is equally noticeable that very important matters in relation to the government and constitution of England have been sacrificed in that article for lack of space. Especially is this remarkable in regard to one of the most debated of English political questions—that of grants to members of the royal family. There is hardly an incident of English affairs as to which less accurate information is possessed by the people at large. The Civil List is the *bête noire* of the demagogue or socialist orator. Reigning in her own right, holding the crown by inheritance and election, the Queen's civil list consists of a fixed Parliamentary grant, annually voted, of £385,000, of which £60,000 is paid into her privy purse, £231,260 is set aside for the salaries of the royal household, £44,240 is paid for retiring allowances and pensions to servants, and £13,200 for royal bounty, alms and special services. This leaves an unappropriated surplus of £36,300, which may be applied in aid of the general expenditure of the court. In addition to this, the Queen has paid to her the annual revenues of the Duchy of Lancaster. The sums allowed to members of the royal family are charged on the consolidated fund, and are annually voted by Parliament. These sums are: £10,000 a year to the Duke of Edinburgh (reduced from £25,000 on the Duke's accession to the dukedom of Saxe-Coburg-Gotha in 1893); £25,000 to the Duke of Connaught; £8,000 to the Empress Victoria of Germany; £6,000 to Princess Christian of Schleswig-Holstein; £6,000 to Princess Louise, Marchioness of Lorne; £6,000 to Princess Henry (Beatrice) of Battenberg; £3,000 to the Grand Duchess of Mecklenburg-Strelitz; £5,000 to the Princess of Teck, formerly Princess Mary of Cambridge; £12,000 to George, Duke of Cambridge; and £6,000 to Princess Helena of Waldeck, Duchess of Albany.

The Prince of Wales, as heir apparent to the crown, is the recipient of £40,000 annually, and in addition receives £37,000 per year for the support and maintenance of his children. He also receives the revenues of the Duchy of Cornwall. The Princess of Wales receives £10,000 annually, to be increased to £30,000 in case of widowhood.

ELECTORS AND ELECTIONS. The Representation Act of 1884 extended to householders in counties the suffrages which previously had been conferred upon householders and lodgers in boroughs, while the Redistribution of Seats Act of 1885 made a new division of the United Kingdom into county and borough constituencies. All elections to Parliament must be by secret ballot. The new Reform Bill has added nearly three million electors to the roll, and there is now one elector to about every six of the population. The present total number of members is 670, against 652 who sat before the passing of the Redistribution Act. The classified lists showing the relative representation of England, Scotland and Ireland in the Lower House of Parliament from the counties, boroughs and universities in 1895 are as follows:

TERRITORIAL	Co.	BOR.	UNIV.	TOTAL.
England and Wales.....	253	237	5	495
Scotland .....	39	31	2	72
Ireland.....	85	16	2	103
Total .....	377	284	9	670

Under the Corrupt Practices Prevention Act of 1883 (amended 1895), election offenses are classified under Corrupt Practices and Illegal Practices. The first include: (1) Treating; (2) undue influence; (3) bribery; (4) personation; (5) knowingly making a false declaration respecting election expenses. The penalties are very heavy. Illegal practices include payment for the conveyance of voters; expenses in excess of amount allowed by statute; voting when disqualified, or inducing disqualified person to vote; publishing a false statement of a candidate's withdrawal, etc. Penalties in these cases are comparatively light.

PREMIERS. The following is a list of the Premiers of the British government from 1880 to 1895. For previous Cabinets, see ENGLAND, Vol. VIII, p. 369.

PRIME MINISTERS.	DATES OF APPOINTMENT.
William Ewart Gladstone.....	April 28, 1880
Marquis of Salisbury.....	June 24, 1885
William Ewart Gladstone.....	Feb. 2, 1886
Marquis of Salisbury.....	July 26, 1886
William Ewart Gladstone.....	Aug. 18, 1892
Earl of Rosebery.....	March 3, 1894
Marquis of Salisbury.....	June 25, 1895

POPULATION OF THE PRINCIPAL CITIES. The census of 1891 shows the population of the principal cities of Great Britain to be as follows:

London, 4,231,431; Glasgow, 618,052; Liverpool, 517,980; Manchester, 505,368; Birmingham, 478,113; Leeds, 367,505; Sheffield, 324,243; Edinburgh, 264,796; Dublin, 245,001; Bristol, 221,578; Bradford, 216,361; Nottingham, 213,877; Hull, 200,044; Salford, 198,139; Newcastle, 186,300; Portsmouth, 159,251; Dundee, 155,675; Leicester, 174,624; Old-

ham, 131,463; Sunderland, 131,015; Cardiff, 128,915; Aberdeen, 123,327; Blackburn, 120,064; Brighton, 115,873; Bolton, 115,002; Preston, 107,573.

AREA AND POPULATION OF THE BRITISH EMPIRE BY COUNTRIES. The following figures are from the returns of 1898:

NAME OF COUNTRY.	AREA IN SQUARE MILES.	POPULATION.
Great Britain and Ireland.....	121,115	40,188,927
Indian possessions, etc.....	1,560,160	287,223,431
Asian possessions.....	90,420	5,801,553
Australasia, etc.....	3,173,442	4,954,039
British America.....	3,780,340	7,150,000
Africa.....	2,878,869	3,4780,241
European possessions.....	110	202,261
South Atlantic.....	7,600	6,529
Totals.....	11,624,080	379,312,078

There is a considerable extent of very recently acquired territory, the exact boundaries of which are as yet undetermined, and of whose population no accurate census has so far been taken.

Of the total population of the United Kingdom in 1891, 18,437,027 were males, and 19,421,126 were females.

In England the density of population per square mile was 484; in Wales, 184; in Scotland, 122; in Ireland, 159.

The approximate annual emigration from the United Kingdom to British North America is 23,760; to the United States, 153,030; to Australasia, 11,200; total, 231,980.

EDUCATION AND RELIGION. Elementary education is now compulsory in the United Kingdom, and in 1889 it was made free in Scotland. On Jan. 1, 1898, there were, in England and Wales, 2,502 school boards, representing a population of 19,918,110. England and Wales have a total of 5 universities (58 colleges); Scotland, 4; Ireland, 2; total, 11; with 1,596 teachers and 24,534 students. The total grants to primary schools in Great Britain (for examination and attendance of scholars) in 1898 was £10,514,504.

In England and Wales the Episcopal continues to be the established church, but all other churches are fully tolerated, and civil disabilities do not attach to any class of British subjects on account of religion. There are 2 archbishops and 33 bishops. At the last census the population claiming membership in the state church was estimated at about 13,500,000, leaving about 12,500,000 to other creeds.

There are many Protestant dissenting religious bodies, the most numerous being the Methodists, reporting about 15,200 chapels, with 801,000 members; the Independents, 360,000 members; the Baptists, 3,842 chapels, with 365,000 members. There are recorded in Great Britain 180 different religious denominations.

The number of Roman Catholics in England and Wales is estimated to be about 1,500,000, with 1 archbishop and 15 bishops.

The number of Jews in Great Britain and Ireland is estimated to be nearly 100,000, of whom 70,000 reside in London.

The number of parishes of the established (Presbyterian) church in Scotland in 1898 was 1,371

with 1,767 churches, chapels, and stations, and 641,803 members. The Free Church (Scotch Presbyterian) has 402,135 members and adherents. The Episcopal Church in Scotland reported 7 bishops, 331 churches, 337 clergy, with a membership of 111,958.

The Roman Catholic Church in Ireland in 1894 was under the supervision of 4 archbishops and 23 bishops, with a total membership of 3,549,856.

The Irish Protestant Episcopal Church had, in 1898, 1,450 churches, with 600,000 members.

There were also, in Ireland, at the census of 1891, 444,974 Presbyterians, 55,235 Methodists, 17,017 Independents, 5,111 Baptists, 3,032 Quakers or Friends, and 1,798 Jews.

REVENUES AND EXPENDITURES. The accounts for the year ending March 31, 1898, reported the government income at £106,614,004, and the expenditure at £102,935,994; surplus £3,678,010.

The income tax is regarded as the most important of the direct taxes. This tax since 1881 has varied from 5d to 8d per pound. In 1883 and 1884 the rate was 5d; in 1885, 8d; in 1886 and 1887, 7d; in 1888 till 1892, 6d; in 1893, 7d; and in 1894-98, 8d. Only incomes over £160 are levied upon, while there is an abatement of £160 on those under £400, and of £100 on those below £500.

THE NATIONAL DEBT. The national debt was greatest at the peace of Paris, 1815. The increase during the war with France, 1792-1815, had been £621,375,628. At the commencement of the Crimean War in 1854, it was £804,226,354; during that war, about three years, it grew to £837,144,597, an increase of £32,918,243. On March 31, 1898, the debt was £634,435,704, or about \$3,090,000,000.

THE BRITISH ARMY. For the year ending March 31, 1899, the army of the United Kingdom consisted of 8,109 commissioned officers, 1,087 warrant officers, 17,100 sergeants, 3,941 drummers, trumpeters, etc., and 150,276 rank and file; a total of 180,513 men of all ranks—an increase of 16,944 over the previous year.

The above figures include only those of the standing army. In addition, there were four classes of reserves and auxiliary forces, viz., reserves, 83,050; militia, 138,961; yeomanry, 11,891; volunteers, 263,963. These, with the standing army at home, and a force of 73,162 in India, make a grand total of over 750,000 officers and men.

THE BRITISH NAVY. The number of seamen and marines provided for the naval service in the estimates for 1898-99, and also for those in the previous year, was as follows:

BRANCHES OF SERVICE.	1897-98	1898-99
For the fleet (including Indian troopships):		
Officers and seamen .....	67,072	72,009
Boys (including 1,950 under training) .....	3,400	3,700
Marines afloat and on shore.....	16,841	17,807
For the coast guard.....	4,200	4,200
Training and various services .....	8,537	8,674
Total, all ranks.....	100,050	106,390

Provision was also made for 24,010 men of the royal navy reserves, 3,010 seamen and marine pensioner reserves, including 94 officers on salary.

The condition of the English navy at the beginning of 1899 is shown by the following table:

	LAUNCHED JAN., 1899.	BUILDING.
Battleships, first class.....	35	10
Battleships, second class.....	7	
Battleships, third class.....	18	
Coast-defense ships.....	14	
Cruisers, Armored.....	9	12
Cruisers, first class.....	30	
Cruisers, second class.....	53	
Cruisers, third class.....	42	2
Torpedo gunboats.....	34	
Torpedo-craft, first class, including 108 "destroyers".....	153	23
Torpedo-craft, second and third class.....	24	
Total.....	419	47

According to estimates, the approximate aggregate cost of the effective and non-effective ships now in commission amounted to £60,000,000, while the incidental expenses amounted to £8,000,000.

In January, 1899, there were 164 ships in commission, exclusive of gunboats, small craft, the coast-guard ships, and training, harbor, and depot ships. The vessels were thus distributed: Mediterranean and Red Sea, 38; Channel squadron, 14; North America and West Indies, 12; East Indies, 9; China, 28; Cape of Good Hope and West Africa, 16; Pacific, 7; Australia, 12; southeast coast of America, 4; particular service, 11; surveying service, 9; training squadron, 4—making a total of 164.

COMMERCE AND INTERNAL COMMUNICATION. The United Kingdom is classed as a free-trade country, the only duties levied being on chicory, cocoa, coffee, dried fruits, plate, spirits, tea, tobacco, and wine, the bulk of all the levies being on spirits, tobacco, tea, and wine. The total imports in 1898 amounted to £470,604,198; and the exports to £294,009,991. The duties are levied on goods valued at £30,000,000, or about 7 per cent of the total imports.

The standard of value is gold. Silver is legal tender up to forty shillings, bronze up to twelve pence. Bank of England notes are legal tender for sums over five pounds sterling.

On Jan. 1, 1898, the railway mileage aggregated 21,433 miles, distributed as follows: In England and Wales, 14,818 miles; in Scotland, 3,447 miles; and in Ireland, 3,168 miles.

On March 31, 1898, the telegraph mileage aggregated 41,516 miles of government lines, with 280,578 miles of wire.

HISTORY SINCE 1874. Taking up the political history of England at the date of the formation of Disraeli's second Cabinet in February, 1874, and at the period at which the article on England, Vol. VIII, p. 368, concludes, the political complexion of the new Parliament is the first matter of interest to note. The Prime Minister was supported by 350 Conservatives in the House of Commons. His political opponents, the Liberals, numbered 244, and a compact and cohesive force of 58 Irish members,

all pledged to Home Rule, was a power, of itself, to help or hinder legislation.

Disraeli's Cabinet was a strong one. He himself was First Lord of the Treasury; Lord Cairns held the great seal as Lord Chancellor; the Duke of Richmond and Gordon was Lord President of the Council; Lord Malmesbury, Lord Privy Seal; Lord Derby, Foreign Secretary; Lord Salisbury, Secretary for India; Lord Carnarvon, Colonial Secretary; Gathorne Hardy (created Viscount Cranbrook in 1878) was Secretary of War; Sir Richard Assheton Cross, Home Secretary; Ward Hunt, First Lord of the Admiralty; Sir Stafford Northcote, Chancellor of the Exchequer; Lord John Manners, Postmaster-General; Lord Sandon, Vice-President of the Council; the Duke of Abercorn, Lord-Lieutenant of Ireland; and Sir Michael Hicks-Beach, Chief Secretary for Ireland. It was almost a second Ministry of All the Talents. Its members, both individually and collectively, left a deep impression on the pages of their country's history. The old Low Church element secured the passage of the Public Worship Regulation Act, and used its defective provisions vigorously against all High Church clergymen whose ritual savored of Romanism. The statute seems a strange one to be passed by a Parliament in which Conservatives were in a considerable majority.

Butt's Home Rule motion was negatived in July, 1874, by a vote of 458 to 61, and the year saw the conclusion of a war with Ashanti. It had been commenced to protect the Gold Coast settlements, had cost the lives of many a brave fellow in the swamps of the pestilential Prah river, and concluded with the downfall of Koffee Kalcalli, the Nero of Ashanti. In October Fiji was definitively annexed to the empire.

In January, 1875, Gladstone took a premature farewell of politics, and resigned the leadership of the Liberal party. His successor was the Marquis of Hartington, a Whig of the old school. An Artisans' Dwelling Act for England, and coercion for Ireland in the shape of a Peace Preservation Act, were early items of the year's legislation.

An Agricultural Holdings Act, passed on August 13, 1875, gave tenant farmers compensation for unexhausted improvements; while a similarly permissive Land Transfer Act enabled the owner of land with a perfect title to obtain expensive registration of the same, but provided no method for clearing a defective title or registering it. Tentative as was the Act, it was also, from the first, a dead letter. The Prince of Wales made an extensive tour of the East Indian empire, 1875-76, cementing the ties which bound many a native ruler.

The year was marked by the extinction of special pleading and pettifogging in the courts of law. The new High Court of Justice, constituted by the Judicature Acts of 1873 and 1875, held its first sitting on Nov. 1st, and by the code of rules then promulgated showed that the old school of lawyers, satirized by Warren and Dickens, and indeed by every author since Chaucer, had passed away. The year was also memorable for Disraeli's purchase in Nov., 1875, of

the Khedive's Suez canal shares. Thenceforth England had a pecuniary interest in the nearest road to India. It was a step toward knitting together the empire, criticised severely at the time, but since fully justified as a sound commercial undertaking.

The year 1876 saw the shameless Bulgarian atrocities of the unspeakable Turk, evoked a ringing protest from Gladstone, and caused two changes in the tottering empire of Islam. The Queen assumed the title of Empress of India, and the nation watched with anxiety the Russian advance toward the Sweet Waters of the Golden Horn. It was the birthday of jingoism, and a powerful fleet was sent to Besika Bay.

Disraeli, created Earl of Beaconsfield in Aug., 1876, sent Lord Salisbury to the conference at Constantinople; and Russia, with the little armies of Roumania, Servia, and Montenegro, began, in April, 1877, the advance into the domains of "The Sick Man of the East." Home Rule (q.v., in these Supplements) began obstruction in this year, and produced closure rules in the House of Commons.

In January, 1878, the Russians had arrived in sight of the minarets along the Bosphorus. The Bear was within striking distance of the city he long had coveted, and in February Europe watched with bated breath the dispatch of the English fleet to Constantinople. The step cost the ministry the support of Lords Carnarvon and Derby, but a vote of credit for \$30,000,000 preceded the calling out of the army reserves and the moving of Indian troops to Malta. Beaconsfield and Salisbury attended the Berlin Congress, and brought home the high-sounding, if dissatisfying, "Peace with Honor." Cyprus fell to England on a division of the spoil, and an Afghan war nerved England to prepare for Russia's advance on her Indian empire.

Wars abroad and agricultural distress at home characterized the commencement of 1879. The soldier savages of Zululand overwhelmed the ill-guarded camp of the Twenty-Fourth Regiment at Isandula, and but for the heroism of Bromhead and Chard at Rorke's Drift, would have raided and ravaged the colony of Natal. The victory of Ulundi (July 4, 1879) followed peace in Afghanistan (June 8, 1879), but the massacre of Cavagnari and his escort in Cabul, Sept. 2-3, led to a renewal of the war. Cabul was occupied (Oct. 12, 1879), while the Irish Land League was formed at home. The office of Public Prosecutor was created, and Gladstone, chafing in retirement, commenced a campaign of vehement denunciation against the policy of Beaconsfield.

The year 1880 brought forth more closure rules in Parliament to meet the increase of obstructive tactics among the Home Rulers. Feb. 23 witnessed a dissolution of Parliament, and Gladstone was, after some delay, called upon to form a ministry. In April the new Parliament met. The campaign had given Gladstone 349 Liberal supporters. His opponents, the Conservatives, were 243 all told, and 60 Home Rulers rendered party divisions problematical on many occasions.

Gladstone's Cabinet included many of the Birmingham school of advanced Liberal ideas. John

Bright was Chancellor of the Duchy of Lancaster; the Marquis of Hartington was at the head of the India office; Joseph Chamberlain was President of the Board of Trade; Sir William Harcourt was Home Secretary; and, outside the Cabinet, W. E. Forster was Chief Secretary for Ireland.

The undignified Bradlaugh episode first attracted the attention of the Lower House. Avowing his atheistic views, the junior member for Northampton first desired to affirm, and then swore himself in. Much litigation followed, but, in the end, the sturdy "Iconoclast" obtained his seat.

Concession to Ireland was the order of the day, and the Peace Preservation Act was allowed to expire, while a Relief of Distress Act, with a Compensation for Disturbance clause, was offered to appease the sixty Irish malcontents, who were so potent to obstruct legislation. Then Gladstone tried to please the farmers with the hand that taxed the brewers in abolishing the malt tax and placing a tax on beer. Local option triumphed by a vote of 229 to 203 in the House of Commons, pleased Sir Wilfred Lawson and the apostles of cold water, but produced no actual legislation. The Burials Bill opened the graveyards of the English state church to Nonconformist funerals, and antagonized the warring creeds and sects. A Ground-Game Act was passed to protect farmers' crops from the depredations of hares and rabbits. An Employers' Liability Act, very fruitful in litigation when not contracted against, preceded a widespread anti-rent agitation in Ireland, an abortive state trial of Parnell and his supporters, and a Boer revolt in the Transvaal.

January, 1881, witnessed the defeat of the impetuous General Sir George Colley at Laing's Nek, in the Transvaal, and Feb. 27 his death at the greater disaster of Majuba Hill. Concession to rebellion was the policy of the Gladstonian Cabinet, and the foundation of future troubles was laid in a hasty peace, while the defeat of Majuba and the treachery of Potchefstroom were unatoned for and unavenged. Significant of a coming storm, the loyal and indignant Cape Colonists held a mock funeral of the British flag.

The policy of withdrawal was also shown in the retreat from Cabul and Candahar. In the eyes of the peace-at-any-price party Roberts's heroic march and Cavagnari's death counted as little to the Indian empire as a scientific frontier. But, goaded to desperation by the Irish agitation and obstruction, the government nerved itself to pass another coercion act for that "Niobe of Nations." More closure became necessary, and thirty-six Irish members, insisting on free speech, were forcibly removed from the House of Commons. An Irish Land Bill caused the sturdy Duke of Argyll to sever his connection with the Gladstonian Cabinet; and April, 1881, saw the nation mourning at the grave of the Earl of Beaconsfield.

In October, Parnell and his fellow Land Leaguers were incarcerated under the obnoxious "suspect" clause of the Coercion Act. The No-Rent Manifesto was issued in retaliation, and the Land League was proclaimed as illegal by a government at its wit's end for a policy that would pacify Ireland and satisfy



the landlord party. Crime held high carnival from Antrim to Kerry, and the suspects in Kilmainham jail ruled the land more potently than did the tenant of Dublin Castle.

The year 1882 opened with another Bradlaugh incident in Parliament, but his expulsion only increased his majority at the hands of the Northampton shoemakers. He was their choice, and in the interest of free thought they returned him again. Gladstone next boldly censured the House of Lords for their committee's emasculation of the Irish Land Act, and inaugurated a futile crusade for the mending or ending of hereditary legislators. The noise was greater than the result, which was nil, but it served to please and employ the new advanced Radical element.

Despairing over its Irish policy, the government made its "Kilmainham Treaty" with the imprisoned Land League suspects. The Lord-Lieutenant of Ireland, Lord Cowper, and Mr. Forster, the Chief Secretary, resigned their offices in disgust, and the ink on this "pact with treason" was barely dry before Lord Frederick Cavendish, who had gone to Ireland as Gladstone's bearer of the olive branch, and Chief Secretary, was murdered, with Mr. Burke, in Phoenix Park. G. O. Trevelyan became Chief Secretary, and another Coercion Act was passed, in spite of strenuous and sustained obstruction.

The revolt of Arabi Pasha in Egypt took the fleet to Alexandria Bay, and in July produced the bombardment of the fortifications. It was not war, said Mr. Gladstone, but John Bright fled from the ministerial fold before the army landed in Egypt and the navy seized the Suez canal. Kassassin and Tel-el-Kebir soon disposed of the insurgent Egyptians, who saw American sailors and marines assisting the British troops in policing Alexandria and protecting Europeans. Blood was once more thicker than water, and the bonds of friendship between the two great English-speaking nations were cemented afresh. Death claimed Charles Darwin one of the brightest stars in the scientific firmament.

More stringent closure rules were adopted in the autumn session of Parliament, and 1883 opened with a series of dynamite outrages, perpetrated by Irish-American irreconcilables, in the fatuous hope of emancipating Ireland. The only result was a drastic Explosives Act, and long sentences of penal servitude for the dupes who did the damage.

The punishment of the Phoenix Park assassins, following that of the Maamtrasna, Lough Mask and Castleisland murderers, served to break up the centers of terrorism in Ireland. The National League took the place of the Irish Land League, and propagated the same inflammatory doctrines as before. Parnell was the recipient of "a national tribute" of one hundred and ninety thousand dollars, designed primarily as a protest against ex-Chief Secretary Forster's exposure of the Land League and its methods, but promoted also as a counter-blast to the Pope's condemnatory letter to the Irish bishops.

Egypt, that bone of contention among the powers, again attracted attention before the reiterated demands for the withdrawal of the English army of

occupation could be complied with. The Egyptian army, under Hicks Pasha, was annihilated by the fanatics under the banner of the Mahdi, and the heroic Chinese Gordon (q.v., in these Supplements) was hurried to the Soudan to arrange for the withdrawal of the garrisons, and to meet his death in beleaguered Khartoum.

A stringent Corrupt Practices Act insured the future purity of Parliamentary elections, and lessened the cost to candidates. A compulsory Agricultural Holdings Act replaced an older and merely permissive statute, while the loose practices and fraudulent trustees of the Bankruptcy Act of 1869 were swept away by a return to official receiverships and the thorough supervision of the Board of Trade. In India, the ill-advised Ilbert Bill, conferring on the native judges jurisdiction over Europeans, aroused a storm of protest, and stimulated the native press to virulent attacks, before the agitation produced the withdrawal of the measure.

The obituary of the year 1883 included Sir George Jessel, the Master of the Rolls, and a leading jurist; Bishop Colenso, famous for his criticisms of the Pentateuch, and his Championship of the Zulu race; General Williams, once famous for his heroic defense of Kars; J. R. Green, the historian; Dr. Moffat, the Nestor of African missionaries and Livingstone's father-in-law; Captain Mayne Reid, the novelist; John Brown, the Queen's body-servant; and Captain Webb, the daring swimmer, who perished in a mad attempt to descend the rapids of Niagara.

The year 1884 witnessed military operations in the eastern Soudan, and an expedition to Bechuanaland under Sir Charles Warren, and, most important of all, Lord Wolseley's campaign for the relief of Gordon in Khartoum. A Franchise Bill was opposed by the Conservative party, and keenly contested until the provisions of the Redistribution of Seats Act was outlined. Votes of censure on the ministry were carried in the House of Lords, and narrowly averted in the Commons. The country was in a turmoil from end to end; Ireland, the agitation against the House of Lords and the operations in Egypt, with a series of dynamite explosions at home, taxed the energies of the Cabinets, and tried the patience of the nation. The year was also marked by the beginning of that "scramble for Africa" which resulted, before a decade had passed, in the colonization or annexation of the major portion of the Dark Continent by European powers. South African colonists bore with thinly veiled hostility the establishment of the robber republics in Bechuanaland. Forced by the action of the Queensland government, Mr. Gladstone at last resolved to establish a protectorate over New Guinea. The impending certainty of Germany seizing the island was the main reason for raising the British flag. Imperial federation, as a political gospel, was born in London, and on the Afghan frontier Sir Peter Lumsden found tracks of the Russian Bear, the Cossack soldiery masquerading as surveying parties.

The year was memorable for the Mignonette cannibalism case (see COLERIDGE, JOHN DUKE, BARON, in these Supplements), and the Lord Chief Justice's own troubles. The poet Tennyson was given

a well-deserved peerage, while the son of Lord Cairns, Viscount Garmoyle, figured as defendant in the Fortescue breach-of-promise suit, and became famous only for the fact that he paid the highest damages on record for blighted affections. In royal circles the death of the Duke of Albany, the Queen's youngest son, and the betrothal of the Princess Beatrice to Prince Henry of Battenberg, were events of note. The deaths of Fawcett, the blind Postmaster-General; Judah P. Benjamin, "The Brains of the Confederacy"; Charles Reade, the novelist; Sir Michael Costa, the composer; and H. J. Byron, the dramatist-author of *Our Boys*, marked the year.

January, 1885, brought the news of the heroic Gordon's death at Khartoum, and produced another partially successful vote of censure. But all interest was transferred to Afghanistan by the Penjdeh incident, and a vote of credit of \$55,000,000 showed the world that England was prepared to battle over broken treaties, even if her ministers deserted one of her noblest sons. The Redistribution of Seats Act passed, Gladstone essayed to re-enact some provisions of the Crimes Act, but the Home Rulers helped the Conservatives, and on the minor question of revenue a hostile majority forced his resignation.

Lord Salisbury took the reigns of office with a Cabinet remarkable for the presence of Lord Randolph Churchill as Secretary for India. A half-breed rebellion in the northwest territories of Canada, under Louis Riel, was speedily and summarily ended, by colonial forces. The death of the Mahdi in Egypt destroyed the cohesive power of harm his forces had, and British troops invaded Burmah and deposed the blood-stained ruler, Theebaw.

At home, Lord Ashbourne's Land Purchase Act was passed for Ireland. Coercion was for a while dropped, and a beneficial Criminal Law Amendment Act passed, for the protection of women and young children from masculine assault.

November and December saw a general election, wherein the Liberals seated 335 members, against 249 Conservatives and 86 Home Rulers.

Ireland held the balance of power at last in 1886, and, significantly, rumors of Gladstone's conversion to the principle of Home Rule began to be current.

The government gave the needed opportunity by promising the suppression of the Irish National League, and at once the Home Rulers voted with the Liberals on Jesse Collings's "three acres and a cow" amendment to the Address. Lord Salisbury resigned, but not before Burmah was formally annexed to the empire, and Gladstone came to power while the socialists and unemployed were rioting in Trafalgar Square.

Home Rule was to be the watchword of the ministry, and defections depleted its ranks of the brightest and best of its men. Chamberlain, Trevelyan, Collings, Bright and all the leading Whigs resolved to take no part in disrupting the Union. The Liberal-Unionist party was formed and became a power in the land. The "classes" were arrayed against the "masses," and all waited for the promised Home Rule Bill. The second reading was lost, and with the echoes of faction riots in Belfast in the air, an appeal to the voters was taken.

The Conservatives came to power with 316 members, supported by 78 Liberal-Unionists. As against these, there were 191 Home Rule Liberals and 85 Irish Home Rulers. Limited local government was announced as Lord Salisbury's panacea for Ireland's ills, and Parnell's Tenant's Relief Bill was voted down. The Plan of Campaign (q.v., under HOME RULE, in these Supplements) was inaugurated, while the Round Table Conference in 1887 failed to win the Liberal-Unionists back to the deserted Gladstonian fold. More closure rules in the House of Commons were passed, and coercion was drastically applied to Irish agitation and lawlessness.

But all politics paled in June before the celebration of the Queen's jubilee. The nation vented itself in bunting and beacon-fires, while a procession of Europe's rulers, or their representatives, marched in all stateliness around Victoria on her road to Westminster Abbey to return thanks for her long and beneficent fifty years' reign.

The Mitchelstown riot and Mr. O'Brien's undergarments kept Ireland indignant and amused by turns, and November saw more rioting in Trafalgar Square.

The year 1888 was one pervaded by the Irish question. A Local Government Bill for England did much to abate the rule of Dogberry, the justice of the peace, and his corrupt or fossil henchman, Bumble, the beadle. The special commission on "Parnellism and Crime" met, and fifty million dollars was voted in Parliament for the purposes of the Irish Land Purchase Bill. The tercentenary of the Armada lit the beacons again throughout the land as it did when the Spaniards menaced the realm of the Virgin Queen. From the Wrekin to Skiddaw the land glowed in memory of a great deliverance.

The beginning of 1889 was marked by Pigott's confession of the "Parnell letter" forgery and by the increased expenditure for naval defenses. The subject of royal grants enabled the Radical element to grow sarcastic at the expense of the Prince of Wales, but in spite of opposition £36,000 annually was voted him, wherewith to provide for his children. The dock-laborers' strike paralyzed London's shipping interest for a time, and gave John Burns the opportunity to pose as "a docker" and to win some fame for the men's victory. A charter was granted to the British South African Company, fated to become a powerful factor in the affairs of Africa in the hands of CECIL J. RHODES; q.v., in these Supplements.

With the advent of 1890, Parliament was mainly concerned with Irish and domestic affairs. In August the island of Heligoland was ceded to Germany in return for African concessions, and the close of the year marked Parnell's fall from power, owing to the disclosures of the O'Shea divorce case.

The year 1891 was remarkable for the cessation of Irish crime and for the acute dissensions in the ranks of the Home Rule party. The renewal of the Triple Alliance for a further term of six years assured the peace of Europe, and England concentrated her energies on Rhodes's African projects. The Bering Sea controversy (q.v., in these Supplements) engaged attention, and Australian federation received a fresh

impetus at the Sydney convention. In the later words of "the laureate of the barrack-room," the "Wards of the Outer March, Lords of the Lower Seas," nerved by the motherland's acceptance of their soldier-citizens in the Egyptian campaign, were commencing to

"talk together, brother to brother's face—  
Thus for the good of your peoples—thus for the Pride of  
the Race."

On January, 1892, occurred the death of the Duke of Clarence and Avondale, direct heir to the throne, and on the eve of his marriage to his cousin, Princess Victoria Mary of Teck. Peace pervaded Ireland, and the government essayed a mild Irish local government measure. Its appointive officers were objectionable to the Nationalists, and though carried by a majority of 92, it died with its second reading. Dissolution of Parliament drew near, and the Ulstermen held monster mass-meetings to protest against the tender mercies of Home Rule in the hands of their opponents. The elections passed, and Gladstone came to power with 355 supporters (270 Gladstonians, 4 Labor members, 72 anti-Parnellites and 9 Parnellites), as against 268 Conservatives and 47 Liberal-Unionists. Not until an actual division did the Conservative ministry formally resign. The numbers showed a majority of 40 for the venerable statesman. In Africa the marvelous development of the Transvaal gold-fields and the Kimberley diamond-mines were as marked as the energy of Cecil Rhodes. Literature this year had to mourn the deaths of Lord Tennyson and Professor Freeman.

The session of the Bering Sea Arbitration Commission occupied the early months of 1893. The question had been a constant source of irritation for seven years, and arbitration was as opportune as was the raising of the rank of the American minister to that of ambassador at the Court of St. James's. In Egypt the arrogance of the young Khedive received a salutary check in an ultimatum dispatched by Lord Rosebery, warning him of deposition if he resisted British policy and dismissed his Cabinet without consulting his English financial adviser. The Afghan boundary witnessed the Chitral campaign, which resulted in a further strengthening of India's scientific frontier.

February was memorable for Gladstone's introduction of his second Home Rule Bill. Welsh disestablishment and local option movements were placated by measures embodying the theories held by advanced Radicals. Abroad, the Bering Sea arbitration concluded its sessions, after eloquent addresses from the counsel employed, and a powerful British fleet participated in the Columbian naval review in New York harbor. The Earl of Aberdeen succeeded the Earl of Derby as Governor-General of Canada, and the Venezuelan boundary question arose on a protest by Ecuador against further British encroachments.

At home, Parliament wrestled with the Home Rule measure, which antagonized the Unionists and failed to satisfy the Irish party. The loss of the battleship *Victoria*, with 22 officers and 336 men, was one of the most appalling disasters of recent times in the history of the British navy.

In August the Bering Sea award was made public. While a technical victory for England on each of the five points submitted, the award established liberal regulations for the future preservation of the seal-herd. Debate on the Home Rule Bill occupied 82 days in the House of Commons. It ended with a disorderly *mêlée* and the measure passed its second reading by a majority of 34 in a house of 572. The bill went to the Upper House and met its fate in a rejection by a vote of 419 to 41.

Rejoicings in England marked the marriage of Prince George of Wales and his cousin. A strike of 500,000 colliers resulted in frequent collisions with the authorities. Negotiations were begun for a settlement of the Canadian damages in the Bering Sea arbitration. A successful mission to Cabul still further strengthened India's scientific frontier. The opening of the Manchester ship-canal served as the occasion for great local rejoicings on the completion of a colossal engineering feat. Noteworthy additions to the navy were made in the *Powerful*, *Terrible*, and *Revenge*. The coal strike was settled by Lord Rosebery's judicious arbitration, and in Matabeleland, the South African Company's troopers overran Mashonaland and Matabeleland, and captured Buluwayo, Lobenguela's chief kraal. The death of Tyndall by misadventure was a severe loss to the world of science.

The year 1894 was rendered memorable by the final retirement of Gladstone from the leadership of his party. Vexed by the rejection of his Home Rule measure by the Lords, disgusted with the quarrels and dissensions among his Irish allies, the veteran statesman laid the mantle of leadership on Lord Rosebery, and turned to his books with an ardor which belied his years. The Bluefields incident caused the landing of British sailors and marines to protect English residents. The headstrong Khedive of Egypt querulously belittled his frontier force, and again received an English ultimatum. An intercolonial conference was productive of good results. Home Rule for Scotland was essayed in April, and a vigorous campaign against the Lords inaugurated. The banquet to the American naval officers in London was memorable, and productive of much international good feeling. The formal opening of the Manchester ship-canal by the Queen, and the opening of the vast Tower Bridge by the Prince of Wales were events of national and local significance. A comprehensive Royal Commission on Labor concluded their labors of three years and issued a voluminous but instructive report. Troubles in the Transvaal between the Boers and the English began to grow serious, while the Venezuelan boundary question took an acute phase owing to Venezuela's invasion of the disputed strip. The death, at Windsor Castle, of Sir John Thompson, the Canadian Premier, cast a gloom over Canada.

Rumors of impending dissolution of Parliament, mixed with angry outbursts against the House of Lords, kept England on the watch for the opening of legislation. Mr. Schnadhorst, the active Liberal "boss" in politics, who had done much to Americanize Liberal politics, retired from the secretaryship of the National Liberal Federation, assigning

overwork as the reason. The launching of the *Magnificent* at Chatham was noteworthy as the first step toward adding seven monster war-ships, each of 15,000 tons displacement, to the British navy. A brief campaign in Waziristan ended in favor of the Indian troops, and the discovery of the new chemical element argon made the year noteworthy among scientists. Literature sustained the loss of James A. Froude and R. L. Stevenson (q.v., in these Supplements).

The year 1895 produced a serious Manitoba schools question, an agitation for a reform in the Canadian copyright laws, and a crisis in Newfoundland. Welsh disestablishment was again essayed, an Irish Land Bill introduced, and Home Secretary Asquith introduced a stringent Factories and Workshop Bill into Parliament. Speaker Peel, son of the great Sir Robert Peel, resigned his office, and it was for a while uncertain whether Lord Rosebery's indisposition would permit him to remain in political life.

The escape of Slatin Bey from a twelve years' captivity in Khartoum was a matter for congratulation. The remarkable productiveness of the Witwatersrand gold-field raised South Africa to the position of second among the gold-producing countries of the world. Death was busy this year, and laid low Professors Blackie and Cayley, Sir George Chesney (of *Battle of Dorking* fame), Lord Randolph Churchill, Sir Patrick Grant, Admiral Hornby, Sir Henry Rawlinson, and Professor Seeley.

The fall of the Rosebery ministry was precipitated by a catch-vote on the army estimates. Lord Salisbury came to power June 25, 1895, at the head of a Unionist ministry, with a general election impending, and a well defined sentiment against Home Rule prevalent. The visit of the Ameer of Afghanistan's second son, a great temperance convention, and the Wilde-Queensberry scandal were events of note. Wilde's conviction was the much-needed excision of a putrid cancer which had developed in a certain small section of London society.

The launch of the *Terrible*, the retirement of the Duke of Cambridge from the command of the Army, the visit of Ashanti envoys, and the conviction of the pious swindler, Jabez Spencer Balfour, for the Liberator frauds, were events of note.

The confession of Arthur Orton (see TICHBORNE, in these Supplements) undeceived the last of his dupes. A knighthood bestowed on Henry Irving met the approval of the entire Anglo-Saxon race. A powerful squadron participated in the opening of the Kaiser Wilhelm canal in Germany. A campaign in Chitral was remarkable for severe fighting. Death claimed Emily Faithfull, Huxley, the noted scientist, and the aged jurist, Sir James Bacon.

The British attempt on Jan. 5, 1895, to annex the island of Trinidad, off the coast of Brazil, evoked a protest from Brazil, and the question of its ownership was submitted to the arbitrament of the King of Portugal, who decided in favor of Brazil, Aug., 1896. The conclusion of delimitation work upon the frontier of the Pamirs was announced.

Parliament convened Feb. 11, 1896, after the general election, with 411 Conservatives and Liberal-Unionists, against 259 Gladstonian Liberals, Labor

members, and Home Rulers. The leaders in Lord Salisbury's cabinet were Joseph Chamberlain, the Duke of Devonshire, and A. J. Balfour. The ministry had hardly settled to work when President Cleveland's fulminating Venezuelan message was in its hands. Jurists by the score were satisfied that the frequently invoked Monroe Doctrine was in no way involved. Much diplomatic correspondence ensued, but the whole matter resolved itself into a case for arbitration, and preparations of evidence at once began. Alfred Austin was appointed poet laureate, and Lord Sackville, the victim of the "Murchison letter," covered himself with ridicule by publishing an attempt at self-exculpation in pamphlet-form. The year's death-roll includes Sir Henry Ponsonby, for many years the Queen's private secretary, George A. Sala, and Sergius Stepniak.

Coming to the year 1896, memorable as marking the Queen's reign as the longest of any ruler of the British Isles, and remarkable for the disturbances in South Africa which ended with the Jameson raid, the early months were occupied with the Venezuelan question, Armenian affairs, and naval defenses. John Dillon was chosen as leader of the anti-Parnellite faction of Home Rulers, and a military expedition to Ashantee cost the nation the life of Prince Henry of Battenberg and plunged the royal household into grief. The death-roll of the year included, also, Sir Joseph Barnby, the composer; Du Maurier, the author of matchless *Trilby*; Archbishop Benson; Thomas Hughes, the author of *Tom Brown's School-days*; Sir Frederick Leighton, and Sir John Everett Millais.

The German Emperor's telegram to President Kruger aroused a storm of protest and jingoism, and sent a splendid particular-service squadron to sea as a sample of what the country was prepared to do. In October Lord Rosebery astonished many by his resignation of the Liberal leadership. At home and abroad all was peace, with the exception of the Anglo-Egyptian successful operations in Egypt, and the nation rejoiced with the Queen on the attainment of the sixtieth year of her reign.

RECENT HISTORY. Since the withdrawal of Lord Rosebery from the Liberal leadership and the weakening of the party on the subject of Irish Home Rule, the British Liberals began to fall into a state of disintegration. This was further helped by the withdrawal from the party leadership in the House of Commons of Sir W. Vernon Harcourt, though his post was taken by Sir Henry Campbell-Bannerman, so far as that rather mild politician could be expected to fill Sir William V. Harcourt's rôle. For a time, however, there was little in the party contests to call for either ability or vigor in a leader of the Opposition, if we except such events as the British acquisition in China of the port of Wei-Hai-Wei, as an offset to Russia's acquisition of Port Arthur and Talienwan and Germany's seizure of Kia-Chau; and the national grant of £30,000 to Lord Kitchener, as a reward for his services in planning and conducting the expedition into the Egyptian Sudan, which culminated in the battle of Omdur-

man, the capture of Khartum, and the overthrow of the power of the Khalifa. The subject of legislative independence for Ireland increased national expenditure, especially on the navy, and the invitation of the Emperor of Russia to the nation to take part in a Peace Conference at The Hague, were topics that called for little discussion at the hands of the Opposition, though the party was soon to find, in the events happening in South Africa, material for active antagonism and biting criticism. This arose in consequence of the failure of England's diplomatic efforts to secure civil rights for her subjects in the Transvaal, and to satisfy its President, Mr. Krüger, that in insisting on England's right of paramountcy in the South African Republic, she had at the same time no desire to aggress on the territorial possessions of the Dutch State or unduly to interfere in its internal affairs. Negotiations with the Transvaal were conducted by the English Foreign Office (Rt. Hon. Joseph Chamberlain, Secretary), through Governor Sir Alfred Milner, High Commissioner at the Cape. Both of these officials, being high imperialists, were distrusted by the Liberal party (at least, by what is known as the "Little Englander" element of it), and so the policy of the Government and the Foreign Office in its relations with the South African Republic was sharply arraigned.

**THE BOER WAR.** Party opposition became more pronounced with the failure of the Bloemfontein Convention in June, 1899, and the subsequent provision that had to be made for increasing the military strength in South African garrisons. Then came (Oct. 9) the ultimatum of the Pretoria government, which fell like a bombshell in England, and threw a sinister light on Mr. Krüger's alleged designs of getting rid for ever of British suzerainty and of driving the English from South Africa. The view taken by the Liberals was that the Boers were being unreasonably coerced; though the Government claimed that its overtures had been fair as well as conciliatory, but that Mr. Krüger was obdurate, and, having craftily prepared his Republic for the eventualities of war, he insolently launched his ultimatum, which England was of course bound to treat as a *casus belli*. The army reserves were at once called out, Parliament was summoned, and the imperial troops were hurried forward to the Cape, together with contingents from India, and, later on, from all the chief colonies of the Crown.

Whether the conflict could have been avoided, it was now too late to discuss. Many of the enemies of the English nation saw in her attitude towards the Boers only her traditional policy of aggression, urged on by her lust of dominion and greed of gold. The Opposition in Parliament deemed the war unjust, since Mr. Krüger's oppression of the Uitlanders in the Transvaal was held to be exaggerated, and that England under the Convention of 1884 had practically abandoned her rights of suzerainty. On the other hand, the Government affirmed that the Uitlanders had undoubted grievances, in being denied the rights of

freemen, in spite of the specific promises of Mr. Krüger that they would be treated with the same equity as the Dutch burghers, and that it had sought throughout the negotiations to bring Mr. Krüger to reason, and thus avert an undesirable and calamitous collision. Mr. Krüger, however, remained obdurate, shuffled in the matter of the franchise, and practically refused all redress. In this attitude, he was no doubt confirmed by the alliance, for offensive purposes, with him of the neighboring Orange Free State, by promises of active support in a rising among his race and kin in Cape Colony, and in the event of war, by hope of intervention on the part of foreign nations. His expectations, with regard to the two latter, were, we know, disappointed, though the Orange State joined him and his people in arms, and in the middle of Oct. (1899) the armed forces of both republics invaded Natal and Cape Colony, and laid siege to the British garrisons in Mafeking and Kimberley.

As we narrate the story of the Boer war elsewhere in these Supplements, the incidents of the year's campaign need not here detain us. Active and serious fighting began, it will be remembered, on the banks of Tugela, when Sir Redvers Buller and the first English army corps arrived in Natal about the third week of November. As the year grew to its close, the seriousness of affairs in the field, with its high list of casualties, necessitated increased British mobilization and the despatch to the Cape of Lord Roberts, with Lord Kitchener as his chief of staff. The new year (1900) saw a total of close upon 200,000 English and Colonial troops in South Africa, opposed to an estimated force of 70,000 Boers (including foreign mercenaries), who had especial advantages in knowing the country, and in a training which, as a body, had given them great mobility as well as made them expert marksmen. With the advent of Lord Roberts and his increased army, a turn came in the tide of battle, and British fortunes improved with the invasion of the Orange Free State and the subsequent crossing of the Vaal and the capture of Johannesburg and Pretoria. After a time, the sieges of Ladysmith, Kimberley, and Mafeking were raised, Cronje's army was surrounded and compelled to surrender, and the Boers were driven eastward to the borders of the Transvaal, the Presidents of both republics taking to flight. Practically, the end of the war came with the British re-annexation of the Boer republics and the decamping of Mr. Krüger and his government-on-wheels to Lorenzo Marques, the Portuguese port on Delagoa Bay. From the latter ex-President Krüger set out (Oct. 20, 1900), for Europe on the *Gelderland*, a warship of the Netherlands.

To the British the cost of the war was exceedingly heavy, the financial expenditure being estimated at \$400,000,000, and the casualties, including killed, wounded, and died from disease, being in the neighborhood of 40,000. The struggle, owing to the sternness of resistance and the bravery of the burghers, cost the Boers heavily, besides the loss of the two Dutch republics, now converted

once more into colonies of the British Crown. Nor can the cost to Britain for a time be small until the country emerges from military into civil rule, and time is allowed for the necessarily slow processes of pacification. As we write, however (Nov. 1900), the Colonial contingents, which admittedly were of invaluable service to the Empire, are being sent to their homes; while the commander-in-chief, Lord Roberts, and his predecessor in the chief command, Sir Redvers Buller, are about to leave the Cape. Already many of the volunteer levies have returned in triumph, including the City of London Imperial Volunteers and the first Canadian contingent. For the services of the Indian troops of the Empire, as well as those of Cape Colony and Natal, of Australia and New Zealand, and of Canada and the Canadian Northwest, Britain has warmly and gratefully made her acknowledgments.

**AUSTRALIAN FEDERATION.** Early in 1899, a gratifying end came to the conferences held in the Australian colonies to bring about Federation. The voting for the amended Commonwealth Bill was passed by large majorities in Victoria, New South Wales, South Australia, Queensland, and Tasmania, the legislatures of which then adopted an address to the Queen praying for the passing of an imperial act constituting the Commonwealth. In the new Federation, the capital of which is to be in New South Wales, at least 100 miles from Sydney, there will be a Senate, consisting of six representatives from each colony, chosen for six years. The House of Representatives will contain about double the number of members returned to the Senate, allotted to the colonies on a population basis, but so that no colony shall have less than five members. The qualification for electors, for both houses, will be the present Parliamentary franchise of their respective colonies. The imperial Parliament duly passed the enabling act, and the Government nominated the Earl of Hopetoun, formerly (1889-95) Governor of Victoria, as first Governor-General of the Australian Commonwealth.

**SAMOA, ASHANTI, AND THE INDIAN FAMINE.** In Nov. 1899, Great Britain made an agreement with Germany, subject to the approval of the United States, whereby she (Great Britain) withdrew all claim to possession of any of the islands, situate in the Pacific, of the Samoan group. The islands, it will be remembered, owing to the rivalry of native monarchs, had been under the control of a commission composed of representatives of England, Germany, and the United States. The administration by these three Powers had however not worked amicably, and the Anglo-German agreement was formulated, whereby Germany became the possessor of Upolu and Savaii, and Tutuila and the other Samoan islands fell to the United States. In England's withdrawal, she received some compensating advantages from Germany, among which were the possession of the Tonga Islands, including the Vavau group and Savage Island, and a readjustment, favorable to Britain, of her claims to the hinterland of the

Gold Coast. During the year 1900, England's colony on the Gold Coast gave her trouble, the native King of Kumassi, the capital of Ashanti, having become restive after his submission to the Crown. Accra, on the coast, is the administrative centre of the colony, but a garrison is maintained inland at Kumassi, which in the summer of 1900, when the Governor of the Gold Coast was visiting the British Resident at the post, was attacked by large bodies of armed natives and for a time was in a critical situation. Relief at length came to the garrison through the gallantry of Colonel Willcocks and a body of native soldiery under English officers; but the entire region is, as we write, in a still unsettled and far from passive condition. The conflicting matter of the hinterland of the colony, which was long a disturbing factor in Anglo-German diplomacy, has been happily settled by the respective governments dividing between them the neutral zone that abuts on the French sphere of influence in West Africa. During the year 1900, large drains were made on the purses of the charitable in England on behalf of the stricken millions in India who suffered, first from the visitation of the Bubonic plague, and then from an appalling famine, caused from the want of rains and the consequent failure of the harvests.

**THE "BOXER" RISING IN CHINA.** From mid-summer 1900 Great Britain was greatly exercised over the anti-foreign rising in China and the attack upon the Pekin Legations. Elsewhere, in these Supplements, the matter is treated of, and hence all that may be noted here is the attention the imbroglia demanded at the hands of Lord Salisbury as Foreign Minister. The anarchic condition of Pekin, and the difficulty for a time in obtaining assurance from the Chinese capital of the safety of the Legations, greatly harrowed the public mind in England, which was further exercised by reports of the massacre of missionaries and their converts in the interior, and, later on, by news of extensive rebel risings in the southern portions of the Chinese Empire. The fact that these lawless outbreaks were condoned, if not actually inspired, by the Palace officials, acting under the authority of Prince Tuan and the Empress-Regent, brought into play the activities of the English Foreign Office and concerted action by the Administration of the United States and the Governments of the chief European Powers. The tragedy at Pekin was not as appalling as was first reported, though the Embassies were for weeks shelled by the "Boxers" and the soldier hordes of the vile Manchu Court, while the German minister was murdered, and the ambassadors were saved from extermination by the gallantry of their own defence. The relief of the Legations was due to the efforts of a combined force composed of American, British, German, Russian, French, British Indian, and Japanese soldiers and sailors who marched from Tien-tsin to the capital, pushed their way into the city, and brought timely succor to the beleaguered diplomats and their families and those who had fled for refuge to the Legations. The approach of the allies was the signal to the

Court to take flight, leaving the city to chaos and to looting by the Legation deliverers. Then followed a lengthened period of diplomatic chaffering, during which Russia made hostile demonstrations in the region of the Amur river and threatened to annex Manchuria. Germany was also loud in her denunciations of the international outrage that had been committed and urgent in her demand for indemnity. Britain and the United States were chiefly concerned as to the guarantees for future good conduct on the part of China, while anxious to preserve the "open door" policy and if possible prevent partition of the Empire. So far as military matters were concerned, all the Powers agreed to act under the German field marshal, Count von Waldersee; but there was no inclination to come to a common understanding as to the course to be pursued in bringing to punishment those who were responsible for the outbreak and the mode of extorting from China, with an adequate indemnity, guarantees for her future good behavior. In October 1900, Lord Salisbury announced that Great Britain and Germany had made a compact providing for uniform and concerted action in China, under both present conditions and future contingencies. The agreement was designed to secure the "open door," for the benefit of all nations, and to oppose partition of the Empire, each Power pledging itself not to violate or permit the violation in others of the integrity of Chinese territory. The compact is a good omen for the early and satisfactory settlement of affairs in the Middle Kingdom, and is also in line with the expressed policy of the United States. As we write, an offer has been made by the Chinese plenipotentiaries proposing that China shall pay to the aggrieved foreign Powers an indemnity of forty million pounds sterling, in sixty instalments, agreeing that the Likin and the customs service shall be under foreign control until the obligation is discharged. Whether this proposal will be acceptable to the Powers, and how far China will go in punishing the instigators and perpetrators of the crime in Peking, and what guarantees she will give that similar outrage shall not again be done to foreigners in the Empire, are matters that at present writing (Nov. 1900), are still in doubt.

**GENERAL ELECTIONS (Oct. 1900).** The attitude of the country towards the Government in view of the South African war, its management, the annexation of the Boer republics, and the policy to be pursued for their pacification and future settlement, was determined in the autumn of 1900 by a general election. The verdict at the polls emphatically endorsed the Administration's war policy, the Salisbury Government being returned to power with even a larger majority than it had previously enjoyed, and this despite Radical opposition to the war, Liberal denunciation of the diplomatic negotiations that had preceded it, and pro-Boer protest against the wiping out of the two Dutch republics in South Africa. The significance of the elections is notable in indicating that the Government had the unabated confidence of the constituencies. We append a summary of the returns,

classifying the votes under Unionists (or Conservatives), Radicals (or Liberals), and Irish Nationalists:

	Un.	Rad	Nat.	Total
England and Wales	345	150		495
Scotland.	30	30		72
Ireland	21		82	103
Government majority, 134	402	186	82	670

When the results of the elections were known, there was a persistent demand throughout the country for cabinet reconstruction. Lord Salisbury, every one admitted, had too heavy a burden on his shoulders in performing the onerous duties of Foreign Minister, in addition to the cares and responsibilities of the Premiership. The war office demanded also a new chief, one best fitted, and having a free hand, to undertake the urgent task of giving the nation a reformed modern army. A new presiding functionary was also needed at the head of the admiralty, to take the post vacated by the Rt. Hon Mr. Goschen. Extra efficiency in other administrative departments was also the demand of the hour, with an infusion of more youthful and vigorous blood in the cabinet. With the large government lead in the House of Commons, Lord Salisbury may be trusted to give heed to the earnest wishes of the people. As we go to press the announcement is made that Lord Salisbury retains the Premiership, but resigns the Foreign Secretaryship, which is assumed by Lord Lansdowne.

**DEATH OF QUEEN VICTORIA.** The opening of the twentieth century spread a pall over the United Kingdom and its dependencies such as the British people had not felt since the demise, in 1861, of the lamented Prince Consort. The sad cause of this was the death of England's beloved and august Queen. The lamented event occurred at Osborne on the Isle of Wight, on the 22nd of January, 1901, the immediate cause of death being a stroke of apoplexy. Her majesty's advancing years had, however, begun to tell upon her, added to the mental strain which in the previous fifteen months she had borne on account of the serious loss of life suffered by her armies in the War in South Africa. At the last, the break down in her health, nevertheless, came unexpectedly, and occasioned widespread sorrow throughout Great Britain and the Empire, and indeed throughout the world. At the bedside of the revered and beloved monarch were the members of the royal family, including Her Majesty's dutiful grandson, Emperor William of Germany. The new occupant of the throne is, of course, her late Majesty's eldest son, Albert Edward, Prince of Wales, who succeeded to the crown as Edward the Seventh. The passing away of Her Majesty, after a long and matchless reign, evoked poignant sorrow throughout the Kingdom, where she was universally honored for her beautiful life and illustrious reign, and was paid the affectionate reverence due to her exalted rank, besides winning the spontaneous loyalty of all who admired a noble woman, mother, and queen.

**GREAT-CIRCLE SAILING**, the course of navigation along the line of shortest distance between two given points on the spherical surface of the globe. See **NAVIGATION**, Vol. XVII, pp. 266-268.

**GREATER WEEVER**. See **WEEVER**, Vol. XXIV, p. 477.

**GREAT FALLS**, a city and the capital of Cascade County, western central Montana, on the Missouri River, near its falls, at the mouth of the Sun River, and on the Great Northern and the Great Falls and Canada railroads. It is 75 miles N.N.E. of Helena. Near by are rich mines of gold, copper, silver, lead, iron and coal and building-stone. It has three reducing-works, which together cost five million dollars. Motive power for factories is furnished by an immense dam at Black Eagle Falls. It has a public library, street-railways, electric lights, city water and a sewer system. Pop. 1900. 14,930.

**GREAT FISH OR BLACK RIVER**, a river of the Northwest Territory of British America, rising in Sussex Lake, about lat. 64° 30' N., long. 108° 45' W., and after an east-northeasterly course of five hundred miles, enters Elliot Bay.

**GREAT FISH RIVER**, a river of western Cape Colony, which rises on the east slope of the Roode Berg, in Middleburg district, flows southeast through a very tortuous course for 230 miles, and empties into the Indian Ocean, 10 miles E. of Port Alfred, in Bathurst.

**GREAT KAI**, a river of southeastern Cape Colony. It is formed by the union of the Black and White Kai, and flows southeast, emptying into the Indian Ocean at lat. 32° 40' S. It was for a long time the eastern boundary of Cape Colony. Length, 150 miles; its bed is very irregular and rocky, rendering the river unfit for navigation.

**GREAT KANAWHA RIVER**. See **KANAWHA RIVER**, in these Supplements.

**GREAT NORTHERN DIVER**. Same as **LOOM** or **LOON**; q.v., Vol. XV, p. 2.

**GREAT PEDEE RIVER**. See **PEDEE RIVER**, in these Supplements.

**GREAT SALT LAKE**. See **UTAH**, Vol. XXIV, pp. 19, 20; and **UNITED STATES**, Vol. XXIII, pp. 794, 795.

**GREAT SLAVE LAKE**, a large irregular body of water in the Northwest Territories of British America, extending from long. 108° to 118° W. Its greatest width is about eighty miles. It is full of islands, and has a few government posts on its shores. It is frozen over for half the year. It is fed by numerous large tributaries, chiefly the Peace River, and is drained by the Mackenzie.

**GREAT WALL OF CHINA**, THE, a renowned national work of China, extending over twenty degrees of longitude, along the northern boundary of the country, traversing mountains and valleys and crossing streams, its total length being fourteen hundred miles. It was designed to protect China against the incursions of Tartar tribes, its construction dating two centuries before the Christian era. The material is chiefly earth and rubbish, flanked by walls of brick and fortified by strong battlemented towers. The height of the structure is from 15 to 30 feet, while the towers are 40 feet square at the

base and about 40 feet high. Having long since become practically useless as a means of defense, it is now only a shapeless ruin. See also **CHINA**, Vol. V, p. 644.

**GRECIAN ARCHITECTURE**. See **ARCHITECTURE**, Vol. II, pp. 401-413.

**GRECIAN GAMES**. See **GAMES**, Vol. X, pp. 63-65.

**GRECIAN MYTHOLOGY**. See **MYTHOLOGY**, Vol. XVII, pp. 153-155.

**GREECE**, the kingdom of the Hellenes. Area, 25,041 square miles. Population 1890, 2,187,208. Capital, Athens, with a population of 114,335. For the geography, history and productions of Greece, see Vol. XI, pp. 80-153. The territory detached from Turkey, consisting of most of Thessaly and a strip of Epirus, was added to Greece by a treaty with Turkey, executed—under pressure of the Great Powers—June 14, 1881. The kingdom, excluding these, is divided into 17 nomarchies. According to the census of 1896 the area and population were as follows:

NOMARCHIES.	AREA, ENGLISH SQUARE MILES.	POPULATION, 1896.	POP. PER SQ. M. 1896.
<b>NORTHERN GREECE—</b>			
Attica and Boeotia.....	2,472	313,069	125.1
Phocis and Phthiotis.....	2,044	147,297	71.9
Acaërania and Ætolia.....	3,013	170,565	56.6
<b>PELOPONNESUS—</b>			
Argolis and Corinth.....	1,442	157,578	104.4
Achaia and Elis.....	1,901	230,251	124.3
Arcadia.....	2,020	167,092	82.7
Messenia.....	1,221	205,798	168.5
Laconia.....	1,679	135,462	86.7
<b>ISLANDS—</b>			
Eubœa and Sporades.....	2,216	115,515	52.1
Cyclades.....	923	134,747	145.9
Corfu.....	431	124,578	289.0
Zante (Zakynthos).....	277	45,032	162.6
Cephalonia (Kephallonia).....	302	83,363	276.0
<b>THESSALY—</b>			
Arta.....	395	30,144	99.1
Trikala.....	2,200	176,773	80.3
Larissa.....	2,478	181,542	73.1
Totals.....	25,014	2,433,806	97.3

**MOVEMENT OF POPULATION**. The chief occupations of the people are the following, in percentages of the population, in Greece and Ionian Islands (census 1889): Agriculture, 40 per cent; shepherds, 9; industries, 6.37; servants, 7.75; laborers, 8.11; commerce, 6.37; landed proprietors, 6.10; seafaring, 3.05; army and navy, 4.80; priests, 1.50. In the ceded provinces (1889): Agriculture, 41.95; laborers, 12.32; industries, 10.21; shepherds, 8.18; servants, 7.24; commerce, 6.47; priests, 1.61.

The nationality of Greece is Hellenic. Most of the Albanians who at various dates during the last 400 years have migrated into Greece have become Hellenized. At present there are not more than 90,000 or 100,000 of distinct Albanian nationality in the whole of Greece. These are scattered in small communities, chiefly over Attica, northward as far as Thebes, then across the Isthmus of Corinth, throughout the ancient Argolis, in the southern districts of Eubœa, and a few of the neighboring isles.



On the other hand, there are large numbers of Greeks in the Ottoman Empire, raising the whole Greek nationality to over 8,000,000, as follows: Greece, about 2,200,000; Asia Minor, 2,000,000; Crete, Cyprus, and other Ottoman islands, 400,000; European Turkey, 3,500,000; total, 8,100,000.

About one-half of the population is agricultural, living dispersed in villages. The principal towns, with their populations in 1896, are the following:

Athens .....	111,846	Calamata .....	14,298
Piræus .....	42,169	Pyrgos .....	12,705
Patras .....	37,958	Tripolitza .....	10,465
Trikala .....	21,149	Chalcis (Euripos) (1889) ..	9,919
Corfu .....	17,918	Argos .....	9,814
Hermopolis .....	17,894	Missolonghi .....	9,476
Volo .....	16,232	Argostoli .....	9,085
Larissa .....	15,373	Hydra .....	6,413
Zante .....	14,650	Spetœæ .....	5,172

EDUCATION. All children between the ages of 5 and 12 years must attend school, but the law is not well enforced in country districts. According to the census of 1889, 86.06 per cent of males and 23.08 of females could read and write. The following are the recent educational statistics of Greece: Universities, 1; gymnasia, 33; Hellenic schools, 297; communal schools, 1,741; elementary, 540; private, 81; ecclesiastical, 5; polytechnic, 1; pupils, 144,098.

The budget under date of Jan. 1, 1894, shows the interest in instruction by the liberal appropriation of \$600,000 by the government for higher and middle education.

REVENUE AND EXPENDITURE. The budget for 1897 estimated the total revenue at \$19,068,787, and the expenditure at \$18,750,518. The total amount of Greek indebtedness in 1898 was about \$144,846,762. Of this sum, rather less than \$1,800,000 is for small outstanding internal indebtedness. In all accounts since 1882, the drachma, the national monetary unit, is reckoned as equal to one franc, in accordance with the agreement of the Latin Monetary Union, of which Greece is a member.

ARMY AND NAVY. All able-bodied males 21 years old are liable to military service, the total period of service being 19 years, of which 2 years must be passed with the colors, 8 and 7 years in the reserve, and the remainder in the militia, or landwehr.

The nominal strength of the army in 1896 was 1,880 officers, and 23,453 non-commissioned officers and men; total, 25,333,—not far short of that of the army of the United States of America at that date.

The navy, at the opening of 1896, consisted of 5 small armor-clads (1,710 tons), carrying two 10-ton Krupp guns in a battery on the upper deck, and four 20-pounders, with a speed of 12 knots; and a wood-built vessel, the *Basalissa Olga* (2,060 tons), carrying four 6-ton and two 5-ton guns, with a speed of 10 knots. One steel armor-clad, the *Hydra*, was launched in 1889; it is 6,000 tons, and is now in commission; another similar vessel has been constructed in France. There are 49 small torpedo boats and launches, and two Nordenfeldt submarine torpedo boats. Of unprotected vessels there are two corvettes (1,300 and 1,800 tons), two cruisers (1,000 tons each, launched 1884-85); 12 gun-vessels (six built 1881-84, the rest old); four gunboats (1880); three revenue vessels (1884); an old steel yacht, an

iron transport, and 17 miscellaneous craft. Including officers and cadets, engineers, paymasters, medical officers, sailors, the navy is equipped with about 3,165 men, all told. The navy is manned partly by conscription from the people of the sea-coast, and partly by enlistment. In 1887 the period of service was made two years instead of one.

INTERNAL COMMUNICATION. Recently the internal communication by roads has improved greatly. There are now more than two thousand miles of roads. In 1893 the canal across the Isthmus of Corinth (about four miles long) was opened for traffic; its total cost was over \$5,000,000, and the time taken to build it 11 years. Railways were open for traffic in 1898 for a length of 591 miles, of which 92 miles belonged to the state.

The telegraphic lines, land and submarine, were of a total length of 5,087 English miles at the end of 1898; length of wire, 6,023 miles. The number of officers was 209. They sent over 980,000 inland telegrams and 413,000 international in the year 1896. Receipts over \$502,900.

Of post offices there existed 356 at the end of 1896, and there passed through the post office 9,444,000 letters and postal cards, and 8,533,000 samples, journals, and printed matter. The receipts average \$422,000 per annum, and the expenses about \$396,770. The total number of letters, postal cards, samples, newspapers, etc., which annually pass through the post office exceeds 17,700,000, of which nearly two-thirds is internal, and the remainder is described as international matter.

COMMERCE. Imports, 1897, \$22,952,395, principally cereals, stones, drugs, yarns and textiles, fish, skins, wood, hardware, sugar, and coffee. The largest importers are Great Britain, Russia, Turkey, and Austria-Hungary, the United States figuring on the list for about \$900,000. Exports, 1897, \$16,146,815, principally currants and other fruits, fresh and dried, ores, olive-oil, wine, tobacco, sponges, raw silk. These goods are mostly exported to Great Britain (almost half the total), France, and Austria-Hungary, the United States figuring on the list for a little over \$538,000.

GREEK LANGUAGE AND LITERATURE. See GREECE, Vol. XI, pp. 126-53.

GREELEY, a city and the capital of Weld County, northern Colorado. It is a considerable trade center, and is situated advantageously at the junction of the Platte and Cache la Poudre rivers, about midway between Cheyenne and Denver, on the Union Pacific railroad. Its educational institutions are of a high order of merit, and have gained for it some reputation. The state normal school, built in 1889 at a cost of three hundred thousand dollars, is located here. Abundance of coal is found near the town, and it has manufactories of vacuum-pumps, elevators, brick, and tiles. It has electric lights and city water. Population 1890, 2,395; 1900, 3,023.

GREELEY, ADOLPHUS WASHINGTON, an American government officer and Arctic explorer; born in Newburyport, Massachusetts, March 27, 1844; graduated at Brown High School in 1860; served as a

volunteer through the Civil War, reaching a captaincy in a colored regiment; after its conclusion entered



GENERAL GREELY.

1881. He and the six survivors of his party were rescued at Cape Sabine, June 22, 1884, by a relief party under Commander Schley, when eighteen of his men had perished from starvation. Two of his party, Lieutenant Lockwood and Sergeant Brainerd, traveled to within 396 miles of the geographical pole, the most northern point then reached. In 1887 Greely was appointed chief of the Signal Service, with the rank of brigadier-general. In 1892 his work as head of the meteorological work in the United States was much reduced by the transfer of most of his duties to the civilian Weather Bureau, a branch of the Department of Agriculture. In 1886 he published *Three Years of Arctic Service*, in which he gave a full account of the expedition to the Arctic regions, and which has been translated into French and German. He received the formal thanks of his native state and of the British government, and gold medals from the geographical societies of London and Paris. He published *American Weather* (1888); *American Explorers and Travelers* (1893); *Handbook of Arctic Discoveries* (1896); and wrote the article on Polar Explorations, in these Supplements.

GREELY EXPEDITION. See POLAR REGIONS, Vol. XIX, pp. 326, 327; and POLAR EXPLO- RATIONS, in these Supplements.

GREEN, ALEXANDER HENRY, an English geologist; born at Maidstone, Kent, England, in 1832; received his early education at Ashby-de-la-Zouche Grammar School, where, as a boy, he acquired a strong taste for geology. He proceeded thence to Cambridge, and obtained the position of sixth wrangler in the mathematical tripos of 1855. Six years later he joined the staff of the Geological Survey, and soon acquired reputation as a sound field-geologist. His most important contribution to the publications of the survey was his masterly volume on *The Geology of the Yorkshire Coal-field*. Being well known in Yorkshire, he obtained the professorship of geology at the College of Science, at Leeds, when first instituted in 1875. In 1888 he was appointed professor of geology in the University of Oxford, in succession to Sir Joseph Prestwich. Professor Green was not only an accomplished geologist, but a vigorous writer, an acute critic and an admirable lecturer. His treatise on *Physical Geology*—intended to form part of a comprehensive work, never completed—remains unsurpassed. He died in Oxford, Aug. 19, 1896.

GREEN, ANNA KATHARINE. See ROHLFS, MRS. ANNA K., in these Supplements.

GREEN, ASHBEL, an American clergyman and educator; born in Hanover, New Jersey, July 6, 1762; the son of Jacob Green, a patriot, a divine and an educator of merit, president of Princeton College in 1757. Ashbel Green served in the Revolutionary War in 1778–82; graduated at Princeton in 1784, where he rose to be professor of mathematics and natural philosophy; pastor of the Second Presbyterian Church of Philadelphia, 1786; chaplain to Congress, 1792; president of Princeton College, 1812–22; editor of the *Christian Advocate*, 1822–34; published a number of sermons and a *History of Presbyterian Missions*, edited the *Autobiography of Jacob Green*, and attempted to bring about a renewal of communication between the Presbyterian and Congregational churches. He died in Philadelphia, May 19, 1848.

GREEN, GEORGE FLEMING, an American inventor; born in Montreal, Canada, March 26, 1832. His parents took him, when seven weeks old, to the present site of Chicago. In his twelfth year he was apprenticed to his father as a cabinet-maker; he took a strong liking to the study of electricity, and managed, by floating minor inventions of his, to secure a better education; he invented the first wire and cord harvester-binder; also a dentist's outfit operated by electricity, and a cash-conveyancer for stores. He soon gave his whole attention to perfecting an electric motor for running street-cars; his resources were supplied him by a factory for making photographic shutters, which he owned and worked in Kalamazoo. His motor was refused a patent by the Patent-Office, but, a few months before his death, his claims were allowed by the circuit court of the District of Columbia. But, before reaping the reward of his life-long struggles, he died in Kalamazoo, Michigan, June 7, 1892.

GREEN, HENRIETTA (ROBINSON,) an American capitalist; born, in 1823, in Massachusetts. Her father was Edward Mott Robinson, who traces his descent to John Howland, one of the signers of the compact drawn up on board the *Mayflower*. A nearer ancestor was Isaac Howland, who acquired a fortune in the whaling industry, his heirs being his granddaughters, one of whom, Abbie, was Hetty Robinson's mother, and the other her aunt. The family residence has been for three centuries at Round Hill, Massachusetts. Miss Robinson was known in New York society as the "New Bedford belle," and on the visit of the Prince of Wales to the United States in 1860 she was one of the few girls specially presented to the heir apparent to the British throne, who took quite a fancy to the ingenuous New York girl. In 1864 she married Edward H. Green, of Bellows Falls, Vermont. He made his fortune in the East Indies as agent of the Russells of London. His income at that time was \$50,000, and he was subsequently president of the Louisville and Nashville line, but retired from business afterward, residing at his native place. To this union two children were born, Edward H. R. (in 1868) and Sylvia (in 1870). The former is president of the Texas Midland railway, a road of 130 miles, pur-

chased and equipped by Mrs. Green; he has taken a prominent part in Texas politics. Mrs. Green is best known in connection with her judicious investment of the \$10,000,000 inherited from her father, which she personally supervises. She is one of the shrewdest financiers of her time, and her money is well invested in the largest cities in the East and West. She is accounted the richest woman in America, and it is not impossible that her fortune may exceed \$100,000,000 in the aggregate.

GREEN, HORACE, an American physician and author; born at Crittenden, Vermont, Dec. 24, 1802. He graduated at the University of Pennsylvania, and at Middlebury College; began practice in Rutland, and afterward spent several years abroad, studying in the hospitals of Edinburgh, London and Paris. On his return he became professor in the Medical College of Castleton, Vermont, and remained there until his removal to New York City in 1850. He was soon afterward chosen professor of the theory and practice of medicine in the New York Medical College, which position he held until obliged by failing health to resign in 1860. Author of *A Treatise on Diseases of the Air-Passages* (1846); *Pathology and Treatment of Croup* (1849); *Report of A Hundred Cases of Pulmonary Diseases* (1858); and other works. He was one of the founders and early editors, in 1854, of the *American Medical Monthly*. He died in Sing Sing, New York, Nov. 29, 1866.

GREEN, JACOB, an American professor and author, son of Ashbel Green; born in Philadelphia, July 26, 1790. Before graduating at the University of Pennsylvania in 1806, he distinguished himself by writing a *Treatise on Electricity*, which attracted wide attention. In 1818 he became professor of chemistry, experimental philosophy and natural history at Princeton, and in 1822 professor of chemistry at Jefferson Medical College, which position he held until his death, which occurred Feb. 1, 1841, in Philadelphia. Author of *Chemical Diagrams*; *Chemical Philosophy* (1829); *Astronomical Recreations* (1829); *A Syllabus of a Course of Chemistry* (1835); *Trilobites* (2 vols., 1832); *The Botany of the United States* (1833); *Notes of a Traveler* (1831); and *Diseases of the Skin* (1841).

GREEN, JOHN RICHARD, an English historian; born at Oxford, in December, 1837. After being educated at Magdalen College School and Jesus College, Oxford, in 1860, he became curate of St. Barnabas Church, a poor parish in the east of London. In 1862 he had charge of Hoxton, and in 1865 was made vicar of St. Philip's, Stepney, adding to his parochial duties constant historical researches in the British



JOHN R. GREEN.

Museum Library. Overwork during the cholera epidemic in 1868 obliged him to retire, and Archbishop Tait made him librarian at Lambeth Palace. His health remained delicate, and his winters were

spent usually on the Continent. He had been a frequent contributor to the *Saturday Review* before, and now he began to work on his *Short History of the English People*, which book he had ready for publication in 1874. As many as 150,000 copies were sold in England alone. This was followed by his larger work, *History of the English People*, in four volumes, to the end of the Napoleonic wars (1877-80). In 1877 Mr. Green gathered a number of his essays into a book under the title *Stray Studies*, and in 1882 published a masterly work on *The Making of England*, wherein he fearlessly and efficiently demonstrated that the foundation of England's greatness lay in its rank and file. In continuation of this he was preparing another work, which was called *The Conquest of England*, when his labors were cut short by death, at Mentone, France, March 9, 1883. In all his writings he showed a lively, but ever trustworthy, imaginative faculty. His characters breathe, move and act on each other as in real life. Distant places and times are made to appear distinct and perfectly natural. He was undoubtedly the first among English historians to give full attention to the study of the "common people" and their social institutions, in contradistinction to writers who follow the destinies of nations solely through the doings of their leaders and the members of the upper classes. In this respect, Green followed such men as Michelet and Louis Blanc in France, and did much to shape the studies of the younger generation of historians, both in Great Britain and in America. His wife assisted him in the completion of his last two books. She also published a remarkable memoir of his life as a preface to the 1888 edition of the *Short History*. Herself a historian of merit, she published a monograph on Henry II (1888), and *Town Life in the Fifteenth Century* (1894).

GREEN, MARY ANNE EVERETT WOOD, a British authoress; born in 1818, at Sheffield, England. Her literary talents were manifest at an early age; in 1841 she removed to London and began her *Lives of the Princesses of England* (6 vols., 1849-55), from documents in the British Museum and private libraries. She edited *Letters of Royal and Illustrious Ladies* (1846); *The Diary of John Rous* (1856); *Letters of Queen Henrietta Maria* (1857). By appointment of the Master of the Rolls, she calendared the papers of the reigns of James I and Charles II (11 vols., 1857-68). She completed the same task for the state papers of Queen Elizabeth (6 vols., 1869-74), and did a great deal more work of a similar nature, thus furnishing invaluable sources of information for the historian and student. G. P. Green, her husband, was a noted painter.

GREEN, ROBERT STOCKTON, an American statesman and jurist; born at Princeton, New Jersey, March 25, 1831; the grandson of Ashbel Green; graduated from Princeton in 1850; studied for the bar and began practice in Elizabeth in 1856; was successively prosecutor of the borough and city attorney; surrogate of Union County (1862); presiding judge of the county courts (1868); he resigned in 1873 to enter the famous New York firm of Vanderpoel, Green and Cuming. Elected, in

1890, vice-chancellor of New Jersey; was called, in 1893, to the court of errors and appeals, the highest judicial resort in New Jersey. In his political career he was successively elected by the Democrats member of Congress (1884), and governor of the state (1886). He was a man of great force of character, learning and integrity. He died in Elizabeth, New Jersey, May 7, 1894.

GREEN, SAMUEL ABBOTT, an American physician; born at Groton, Massachusetts, March 16, 1830; graduated from Harvard College in 1851; took his medical degree in 1854. After spending several years in Europe, he returned and settled in Boston. At the commencement of the Civil War he was commissioned assistant surgeon of the First Massachusetts Regiment of volunteers; was surgeon of the Twenty-fourth Massachusetts Regiment from 1861 to 1864; had charge of several hospital-ships; organized the Roanoke Cemetery, the first national burial-ground for Union soldiers; for his services in the field he was brevetted lieutenant-colonel of volunteers. He was city physician of Boston from 1871 to 1880, and was elected mayor in 1882; gave much of his attention to American historical researches, and was made librarian of the Massachusetts Historical Society. Author of *A History of Medicine in Massachusetts; Groton During the Indian Wars* (1883); *Epitaphs from the Old Burying-Ground in Groton, Massachusetts* (1879); *Groton Historical Series* (20 numbers, 1883-87); and other works, pamphlets and articles.

GREEN, SETH, an American pisciculturist; born in Rochester, New York, March 19, 1817. He received a common-school education, and for some years was proprietor of the only fish and game market near his home. Having a passion for hunting and fishing, he became interested in the habits of fish, and conceived the idea of artificial propagation. Observing that the male salmon consumed the greater part of the spawn discharged by the female, he suggested the plan of securing the spawn in shallow pans with the least possible depth of water that would allow hatching, and thus succeeded in hatching 95 per cent of salmon-eggs. Invited to New England to superintend the stocking of the Connecticut River with shad, he invented an apparatus that was successful. As a result of his transporting the first shad ever seen in California, in 1871, over one million marketable shad were fished and sold in 1885 on the Pacific Coast. He wrote *Trout-Culture* (1870) and *Fish Hatching and Catching* (1879). Much of the advancement made in pisciculture was due to his efforts, and he received recognition from foreign societies as well as from his native country. In 1868 he was appointed one of the fish commissioners of New York, and was soon afterward made superintendent of fisheries in that state. He died in Rochester, New York, Aug. 20, 1888.

GREEN, THOMAS HILL, an English philosopher and educator; born at Birkin, Yorkshire, England, April 7, 1836; was educated at Rugby and Balliol College, Oxford, and in 1860 was elected fellow of Balliol; in 1862 he won the chancellor's prize for the best essay on morals; became successively tutor (1866) and master (1870) of Balliol. He was re-

lected fellow in 1872; was elected in 1878 Whyte professor of moral philosophy. His example and influence both in and out of the university were potent for good, and his Neo-Hegelian tendencies still dominate the philosophical teachings of his successors. Among his leading works are his joint translation of Lotze's *Metaphysics* (1884); his *Prolegomena to Ethics* (1883); and his *Introduction to Hume's Treatise on Human Nature* (2d ed., 1886). Most of his works were published after his death, which occurred at Oxford, March 15, 1882.

GREEN, WILLIAM HENRY, an American scholar and clergyman; born at Groveville, Burlington County, New Jersey, Jan. 27, 1825; graduated at Lafayette College in 1840, and studied theology at Princeton. Ordained to the Presbyterian ministry in 1848, he became pastor of the Central Presbyterian Church of Philadelphia in 1849; in 1851 was appointed to the professorship of Hebrew and Old Testament literature in Princeton Seminary. He was chairman of the Old Testament Company of the American Committee of Revision. He declined the presidency of Princeton in 1868. Author of *Hebrew Grammar* (1861); *Hebrew Chrestomathy* (1863); *The Pentateuch Vindicated from the Aspersions of Bishop Colenso* (1863); *The Argument of the Book of Job Unfolded* (1874); and numerous other books and papers on the ancient Scriptures and on theological subjects.

GREENAWAY, KATE, an English artist, widely known as a book illustrator; born in London in 1855; the daughter of a wood-engraver of merit; she studied at Heatherley's Art School and at South Kensington, and in 1872 exhibited a series of black and white designs at the Dudley Gallery. These displayed marked and original talent, and procured her many commissions for illustrating juvenile works. Her *Under the Window* was the child's book of the year 1879. *Mother Goose* (1881) was, if possible, more popular. Ruskin turned a pretty phrase in her honor and described her work as "essentially and perfectly that of true picture color. . . . The children are there, but no railway trains or charitable institutions, for, like a graceful Gallo, she cares for none of these things." Miss Greenaway's range of work is narrow, but it is copious and charming.

GREENBACK-LABOR PARTY. See LABOR PARTY, in these Supplements.

GREENBACK PARTY, called by its members the Independent National, was organized in 1876, and was the outgrowth of the Granger and Labor Reform movements. Its convention at Indianapolis in May, 1876, "demanded the unconditional repeal of the Specie Resumption Act of Jan. 14, 1875"; urged the issue of United States notes as a circulating medium, and the suppression of bank paper; and protested against the further issuing of gold bonds, and the purchase of silver to replace the fractional currency. Peter Cooper was nominated for President, and received 81,740 votes. In 1880 its candidate was James B. Weaver, who received 307,306. After this year it ceased to exist as a political party, its members joining the different popular organizations.

GREEN BAY, a city and the capital of Brown

County, central eastern Wisconsin. (See GREEN BAY, Vol. XI, pp. 162, 163.) It is situated on Fox River, and on the Chicago, Milwaukee and St. Paul, the Chicago and North-Western, and the Green Bay, Winona and St. Paul railroads. The lumber shipped annually averages 80,000,000 feet, and 200,000,000 shingles and 6,000,000 staves, on the average, are shipped yearly, and it has a large trade in white-fish and trout. Calcic magnesian springs are found in the vicinity, and have made Green Bay a summer and health resort. Population 1890, 9,069; 1895, 18,290,—part of this great increase being due to its consolidation with Fort Howard, with 4,754 inhabitants.

GREENBRIER, a river of eastern West Virginia, which rises in the Rich Mountains, northern Pocahontas County, flows southwest for 150 miles, when it meets the New River, at Hinton, Summers County. This river constitutes part of a proposed water route, with the Great Kanawha and the James rivers, between the Atlantic and the Mississippi valley.

GREENBRIER MOUNTAINS, a ridge extending through Pocahontas County, West Virginia, parallel with the Greenbrier River, and about five miles to the west. They are about 2,000 feet in height, and the scenery of the region is remarkably fine.

GREENBUSH, a village of Rensselaer County, central eastern New York, on the Hudson River, opposite Albany, on the Boston and Albany and the New York Central and Hudson River railroads. It has car and machine shops, large freight-yards, a tannery, saw-mills, cigar factory and pork-packing establishment. It also has an R. C. convent. Pop. East and North Greenbush (1900), 4,551.

GREENCASTLE, a city and the capital of Putnam County, central western Indiana, on the Cleveland, Cincinnati, Chicago and St. Louis and the Louisville, New Albany and Chicago railroads. Block coal, timber, sandstone, limestone and some iron ore are found in the vicinity. There are excellent schools, and De Pauw University is located here (q.v., in these Supplements). Among the manufactures are iron and nails. Population 1890, 4,390; 1900, 3,661.

GREENCASTLE, a post borough of Franklin County, central southern Pennsylvania, 63 miles S. of Harrisburg, on Cumberland Valley railroad, and four miles from the Maryland line. It has agricultural machine and church-organ works, a woolen-mill and a high school. Population 1900, 1,463.

GREEN COVE SPRINGS, a town and the capital of Clay County, northeastern Florida, on St. John River, 30 miles S. of Jacksonville, on the South-western and the Jacksonville, Tampa and Key West railroads. It contains a large sulphur spring highly efficient in the treatment of rheumatic troubles. The city has a large business in shipping early fruit and vegetables and lumber; it manufactures woodwork and bricks, and builds and repairs cars. Population 1890, 1,106; 1900, 929.

GREENE, a village of Butler County, northeastern central Iowa, on the Shell Rock River and the Burlington, Cedar Rapids and Northern railroad, 35 miles N.W. of Cedar Falls. It has a good graded school, several churches and grain-warehouses, butter

and egg packing establishments, and is surrounded by a great cattle-raising region. Population 1890, 845; 1900, 1,102.

GREENE, CHARLES EZRA, an American engineer; born in Cambridge, Massachusetts, Feb. 12, 1842; graduated at Harvard in 1862; served as volunteer in the Civil War; graduated as C.E. from Boston School of Technology in 1868; appointed professor of civil-engineering at the University of Michigan in 1872; as a practical engineer, directed several public works; among others, the construction of the Huron trestle-bridge at Ann Arbor; author of *Graphics for Engineers, Architects and Builders* (3 vols., 1876-80); and other works.

GREENE, FRANCIS VINTON, an American soldier and writer; son of Gen. G. S. Greene; born in Providence, R. I., June 27, 1850; graduated from West Point in the engineer corps, January, 1874; joined the American legation in St. Petersburg as attaché in 1877, and followed the Russian army in the field for one year. For a time he was instructor in practical engineering at West Point. He has written an account of the *Russian Army and Its Campaigns in Turkey in 1877-78* (2 Vols., 1879). In the Spanish-American War he served under Major-General Merritt in the Philippines, and took part in the assault and capture of Manila, Aug. 13, 1898.

GREENE, GEORGE SEARS, an American soldier; born in Apponaug, Warwick, Rhode Island, May 6, 1801; lineal descendant of the John Greene who came from England and settled in Warwick, Rhode Island, in 1645; graduated second in his class at West Point, and entered the artillery in 1823. After occupying various positions, among them that of professor of mathematics at West Point, he resigned from the army in 1836 to follow civil-engineering. He took charge of various public works until he was appointed engineer of the Croton water-works, supplying New York city, in 1857. On the outbreak of the Civil War he was appointed colonel of the Sixtieth New York Volunteers, and in 1862 brigadier-general; participated in the battles of Cedar Mountain, Antietam, Chancellorsville, and Gettysburg; severely wounded and disabled at Wauhatchie (1863), later joined General Sherman's army, and was mustered out in 1866, being brevetted major-general of volunteers. After leaving the service he resumed work on the Croton aqueduct and other public works. Died in Norristown, N. J., Jan. 28, 1899.

GREENE, GEORGE WASHINGTON, an American author, grandson of General Nathaniel Greene; born in East Greenwich, Rhode Island, April 8, 1811; United States consul at Rome from 1837 to 1845; professor of modern languages at Brown University (1848); removed to New York City (1852), where he edited *Addison's Works, with Notes* (6 vols., 1853); appointed professor of American history at Cornell University (1872); wrote a number of works, from a *French Grammar to a Life of Nathaniel Greene*, his grandfather; also a number of *Historical Studies* (3 vols., 1867-71). He died at East Greenwich, Feb. 2, 1883.

GREENE, NATHANIEL, an American journalist and author; born at Boscawen, New Hampshire,

May 20, 1797; died in Boston, Nov. 20, 1877; started life as an apprentice in the New Hampshire



NATHANIEL GREENE.

office (1809); editor of the Concord *Gazette* (1812); had charge of various New Hampshire papers, until he founded the *Essex Patriot* (1817); in 1821 he established the *Boston Statesman*, which soon became the leading Democratic daily of Massachusetts; postmaster of Boston in 1829-40, and again in 1845-49. From 1849 to 1871 he resided in Paris, and from that time

gave all his attention to high-class literature. His many poems, under the *nom de plume* of "Boscawen" were quite successful; he published, also, a number of *Tales from the German, Italian and French* (1843) and *Improvisations and Translations* (1852). He died in Boston, Nov. 20, 1877.

GREENE, SAMUEL D., an American naval officer; born in Cumberland, Maryland, in 1839; graduated at Annapolis, and in 1861 volunteered on the ironclad *Monitor*. He had charge of the guns during her fight with the *Merrimac*, and commanded her after Lieutenant Worden had been disabled. In 1862 he served on blockade duty, in 1872 became commander, and held various appointments in the naval academy. He died Dec. 11, 1884.

GREEN EARTH, a mineral of a green color and earthy character, often found in the vesicular cavities of crystalline igneous rocks, sometimes also disseminated through highly decomposed basic eruptive rocks. It consists principally of silica, alumina, magnesia, and protoxide of iron. *Glaucosite* is the name given to the green earth which is not infrequently met with in sedimentary rocks. In such rocks, glauconite occurs in the form of grains, which in many cases are the casts of minute shells. There is also a green earth used as a pigment by painters in water-colors, who know it by the name of *mountain-green*. For their use it is mostly brought from Monte Bolso, and from Cyprus. See also HOLLAND, Vol. XII, p. 62.

GREENEBONY (*Jacaranda mimosifolia*), a member of the family *Bignoniaceae*, a tall and graceful tree of Brazil, which furnishes a beautifully tinted and fragrant timber of great value. It is one of the sources of the "rosewood" of commerce. This plant produces a substance used by dyers in giving yellow, brown and green tints to fabrics.

GREENEVILLE, a village and the capital of Greene County, eastern Tennessee, 75 miles N.E. of Knoxville, on the Southern railroad, and near the Tennessee River. It was the home of President Andrew Johnson. Greenville and Tusculum College (founded 1794) is near the village. Manufacturing products, axles, tobacco and wool; agricultural products, stock and poultry; mining products, coal and iron. Population 1890, 1779; 1900, 1,817.

GREENEVILLE, a town and railroad center, and the capital of Hunt County, northeastern Texas, on

the Sabine River, and on five railroad branches, which connect directly with all the large cities of the state. It is 45 miles N.E. of Dallas. It is surrounded by farming-lands, and ships large quantities of produce; has flour and planing mills and furniture factories. Population 1890, 4,330; 1900, 6,860.

GREENFIELD, a city of Green County, western Illinois, 50 miles N. of St. Louis, on the Chicago, Burlington and Quincy and the Litchfield, Carrollton and Western railroads. It has flour and furniture factories, and exports cattle, swine, horses, grain and agricultural produce. Population 1900, 1,085.

GREENFIELD, a city and the capital of Hancock County, central Indiana, situated on the Columbus, Chicago and Indiana Central railroad, 21 miles E. of Indianapolis. It has large flouring-mills, planing and rolling mills, a furniture factory, a machine-shop and factories of stoves, nails, ice, glass, butter and cheese. It has good schools and is lighted with electricity and natural gas. Population 1890, 3,100; 1900, 4,489.

GREENFIELD, a town and the capital of Adair County, southwestern Iowa, situated on the Chicago, Burlington and Quincy railroad, 50 miles S.W. of Des Moines. Population 1900, 1,300.

GREENFIELD, a town and the capital of Franklin County, northwestern Massachusetts, located in the valley of the Connecticut and the Green rivers. It is on the Boston and Maine, the Fitchburg and the New York, New Haven and Hartford railroads. It is an important market for cattle, sheep and butter, and has manufactories of children's carriages, bolt-cutting machines, planes, boots and shoes, cutlery and silverware. A soldiers' monument is erected here, and the town contains a young ladies' seminary and a public library. Population 1890, 5,252; 1900, 7,927.

GREENFIELD, a village and the capital of Dade County, southwestern Missouri, 35 miles W.N.W. of Springfield, on the Kansas City, Fort Scott and Memphis railroad. Agricultural products and livestock, and coal, lead and zinc are shipped. Population 1890, 908; 1900, 1,406.

GREENFIELD, a village of Highland County, southwestern Ohio, on Paint Creek, on the Baltimore and Ohio Southern and the Ohio Southern railroads. It is an agricultural district, and is a shipping and trading center. Population 1900, 3,979.

GREENHALGE, FREDERIC THOMAS, American statesman; born in Clitheroe, Lancashire, Eng., July 19, 1842; arrived with his parents in the United States in 1855 and settled in Lowell, Massachusetts; entered Harvard College in 1859, but was compelled to leave at the end of two years. He was admitted to the Middlesex bar in 1865; appointed special justice of police court in Lowell, Massachusetts, in 1874; mayor of Lowell in 1880-81; in Massachusetts legislature in 1885; Representative in Congress, 1889-90; governor of Massachusetts, 1894, 1895, 1896; and died in Lowell, March 5, 1896.

GREENHOUSE. See HORTICULTURE, Vol. XII, pp. 221-225.

GREEN ISLAND, a village of Albany County, central eastern New York, on an island lying in the Hudson River, between Troy and West Troy, with

which places it is connected by bridges. It is on the Delaware and Hudson and the New York Central and Hudson River railroads. Machinery, castings, iron and many railroad cars are manufactured here. Population 1890, 4,463; 1900, 4,770.

**GREENLAND, EXPLORATIONS IN.** See **POLAR EXPLORATIONS**, in these Supplements.

**GREEN MOUNTAINS**, a range of the Appalachian system of mountains. See **VERMONT**, Vol. XXIV, p. 166.

**GREENOUGH, RICHARD SALTONSTALL**, an American sculptor, brother of Horatio (see Vol. XI, p. 173); born in Jamaica Plain, Massachusetts, April 27, 1819, and educated at the Boston Latin School. He began his career as a sculptor in Paris; returned to the United States and resided for several years in Newport, Rhode Island; but after 1874 spent most of his time in Europe. He was particularly successful as a sculptor of portrait busts. Among his works are a bronze statue of *Franklin*, executed in 1853, and placed in the City Hall Square of Boston; a marble statue of *Governor Winthrop*, finished in Florence, 1855-56, for the Mt. Auburn Cemetery; and another colossal statue of the same subject, ordered for the national capitol; the *Boy and the Eagle*, owned by the Boston Athenæum; a *Carthaginian Woman*; *Elaine*; *Circe*; and a bust of *Shakespeare*, from the Chandos portrait.

**GREEN PIGMENTS.** See **PIGMENTS**, Vol. XIX, p. 88.

**GREENPORT**, a village of Suffolk County, Long Island, southeastern New York, the eastern terminus of the Long Island railroad, 95 miles from Brooklyn. It has shipyards, and the people are chiefly employed in fishing, shipbuilding and the coasting trade. On account of its bathing and fishing facilities, it is a popular resort. Population 1900, 2,366.

**GREEN RIVER**, a river of Kentucky, which rises in Lincoln County, near the center of the state, flows west as far as Ohio County, where it turns northwest, and enters the Ohio River about six miles above Evansville, Indiana. It passes near the mouth of the Mammoth Cave, and traverses the western coal-field of Kentucky. Its length is estimated at 350 miles, and it is navigable, at high water, 200 miles, by means of locks and dams.

**GREEN RIVER**, the name of three small rivers of western Massachusetts. One rises in the Berlin Mountains, northwestern Berkshire, and flows 15 miles northeast into Hoosac River. A second rises in Lockbridge township, central western Berkshire County, and flows south into the Housatonic, after a course of about 18 miles. A third rises in Windham County, Vermont, flows southeast, entering the Deerfield at Greenfield, Franklin County, Massachusetts. Its length is about 30 miles. The famous Green River Works (cutlery) are located on this stream.

**GREEN RIVER**, a branch of the Colorado. It rises in the Wind River range, Fremont County, western Wyoming, and pursues a generally southward course into Utah, uniting with Grand River near lat. 38° 5' N., long. 109° 54' W. Its entire length is estimated at 750 miles, but it is not of much importance for navigation. In northern Utah

it is bordered by cliffs two or three hundred feet in height, and as it approaches its confluence with Grand River the depth of its cañons gradually increases, and for scores of miles it runs more than 3,500 feet below the surface of the surrounding mesas.

**GREENSAND.** See **GEOLOGY**, Vol. X, pp. 357-359.

**GREENSBORO**, a town and the capital of Hale County, central western Alabama, on the Southern railroad, 73 miles S.W. of Birmingham; located near the cane-brake region, which before the Civil War was noted for its productiveness. Southern University, under Southern Methodist Episcopal Church control, is located here, also Tullibody Academy and a non-sectarian college for women. It has a carriage factory, and is the trade center for a cotton-raising district. Pop. 1890, 1,759; 1900, 2,416.

**GREENSBORO**, a city and the capital of Greene County, north central Georgia, situated on the Georgia railroad, 87 miles from Augusta. It contains a court-house, several churches, the Thomas Stocks Institute and the Fuller Academy. It is in a corn, cotton and hay raising region. Population 1890, 1,313; 1900, 1,511.

**GREENSBORO**, a city and the capital of Guilford County, northeastern central North Carolina, located 82 miles N.W. of Raleigh, on the Cape Fear and Yadkin Valley and the Southern railroads. It contains spoke and handle manufactories, saw and planing mills and agricultural-machine works, and also hosiery, cotton, brick, tiles, terra-cotta and casting manufactures. Much tobacco, wheat, corn, oats and fruit are raised in the vicinity, and considerable fruit is dried and shipped farther south; gold, copper and iron are found in the vicinity. It contains Bessemer steel-works. It is the seat of the Greensboro College for girls, Bennett College for colored youth, the latter being co-educational, and the State Agricultural and Mechanical College for colored students. Population 1900, 10,035.

**GREENSBURG**, a city and the capital of Decatur County, southeastern Indiana, situated 47 miles S.E. of Indianapolis on the Cleveland, Cincinnati, Chicago and St. Louis railroad. There are quarries here, where fine Bedford stone, an oolitic limestone, is obtained and shipped. Among the manufactures are flour, woolen goods, furniture and carriages. The city has a pork-packing establishment and a foundry. Population 1890, 3,596; 1900, 5,034.

**GREENSBURG**, a borough and the capital of Westmoreland County, southwestern Pennsylvania, 31 miles E. of Pittsburgh on the Pennsylvania railroad. Coal and natural gas are abundant; grain, wool, coke and farming products are shipped from this point. Manufacturing products include flour, glass, engines, lumber, bolts and nuts. Population 1890, 4,202; 1900, 6,508.

**GREEN SICKNESS OR ANÆMIA.** See **DIE-TETICS**, Vol. VII, p. 206.

**GREEN SNAKE**, a common name generally applied to two different kinds of harmless grass snakes of the United States, *Cyclophis vernalis*, common in the Middle and Northern states, and *Cyclophis æstivus*, a climbing species, which inhabits the Mid-

dle and Southern states. They are slender in form and of a bright green color.

GREENSTONE OR DIORITE. See GEOLOGY, Vol. X, p. 235.

GREEN TURTLE. See TORTOISE, Vol. XXIII, p. 459.

GREENUP, a village and the capital of Greenup County, northeastern Kentucky, situated on the Eastern Kentucky railroad and on the Ohio River, about 20 miles from Portsmouth, Ohio. There are several iron furnaces near the village, and coal is mined in the vicinity. Population 1900, 711.

GREENVILLE, a city and the capital of Butler County, southern central Alabama, 45 miles S. of Montgomery on the Louisville and Nashville railroad. It has a college and the South Alabama Female Institute, a shingle factory, a boot and shoe factory and saw-mills. Cotton and timber furnish the chief industries. It has a street-railway and water-works. Population 1890, 2,806; 1900, 3,162.

GREENVILLE, a city and the capital of Bond County, southern central Illinois, 50 miles E.N.E. of St. Louis, Missouri, on the Jacksonville, Louisville and St. Louis and the Terre Haute and Indianapolis railroads. Almira Female College is located here. It is in a corn and wheat-growing and milk-producing region, and has coal-mines. It manufactures wagons, plows, flour and lumber. Population 1890, 1,868; 1900, 2,504.

GREENVILLE, a village and the capital of Muhlenburg County, central western Kentucky, situated on the Ohio and Southwestern railroad, 37 miles S. of Owensburg. It has a college for women and several tobacco factories, and there are coal-fields in the vicinity. Population 1900, 1,051.

GREENVILLE, a city of Montcalm County, southeastern central Michigan, on Flat River, which has two dams at this point, and thus furnishes the abundant water-power utilized in the flour, saw, planing and shingle mills, and the machine-shops and woolen-mill. It is on the Detroit, Lansing and Northern and the Toledo, Saginaw and Muskegon railroads, 25 miles E.N.E. of Grand Rapids. It is surrounded by good farm land, and is a trading center for Flat River lumbering district. Population 1900, 3,381.

GREENVILLE, a town and the capital of Washington County, eastern Mississippi, situated on the Mississippi River, 100 miles N.N.W. of Jackson. It is the western terminus of the Greenville, Columbus and Birmingham railroad. It has cotton-compresses and oil-mills, saw and planing-mills, and good public schools. Considerable cotton is shipped here. Population in 1890, 6,658; 1900, 7,042.

GREENVILLE, a town and the capital of Pitt County, eastern central North Carolina, on Tar River (navigable), 15 miles above Washington, and on the Atlantic Coast Line railroad; the surrounding region is rich, producing cotton, tobacco, peanuts, grains, vegetables and fruits. It contains numerous schools, and manufactures carriages, lumber, and paints. Population 1900, 2,565.

GREENVILLE, a city and the capital of Darke County, central western Ohio, on Greenville Creek and on the Dayton and Union and the Pittsburg,

Cincinnati, Chicago and St. Louis railroads, 35 miles N.W. of Dayton. It has planing-mills and a furniture factory. In 1793 a fort was built here by General Wayne, and two years later he signed a treaty here with the Indians. It is supplied with natural gas. Population 1890, 5,473; 1900, 5,051.

GREENVILLE, a post-borough of Mercer County, northwestern Pennsylvania, on the Shenango River, at the head of the Shenango Valley, and on the Erie and Pittsburg and the Pittsburg, Shenango and Lake Erie railroads. It has abundant water-power, a rolling-mill and coal-works, iron foundries and woolen-mills. Thiel College, under Evangelical Lutheran control, is located here. Population 1890, 3,674; 1900, 4,814.

GREENVILLE, a city and the capital of Greenville County, northwestern South Carolina, on the Reedy River and on the Carolina, Knoxville and Western, the Port Royal and Western Carolina and the Southern railroads. Its high elevation and the beautiful scenery of the Blue Ridge, near by, make it a pleasant summer resort. It is also a great manufacturing city; carriages, wagons and cotton are among its chief productions. The city is the seat of Furman University and Greenville Female College, and a theological school, all under Baptist control. Population 1890, 8,607; 1900, 11,860.

GREENWEED, a name given to certain half-shrubby species of *Genista*. Hairy greenweed (*G. pilosa*) is sometimes grown in France on light soils as fodder for sheep.

GREENWICH, a borough of Fairfield County, southwestern Connecticut, 6 miles E. of White Plains, New York, on Long Island Sound and the New York, New Haven and Hartford railroad. It has popularity as a summer resort. The famous escape of General Putnam from General Tryon's troops by riding down the stone steps at Horseneck in 1779 took place in this township. Population, 1900, borough, 2,420; town and borough, 12,172.

GREENWICH, a village of Washington County, central eastern New York, situated on the Greenwich and Johnsonville railroad and on the Battenkill River, about 16 miles E. of Saratoga Springs and 30 miles N.E. of Troy. It contains five paper-mills, thread and twine-mills, scale-works, knitting-mill, pulp-mills, foundry, machine-shop and shirt factories. Population 1890, 1,663; 1900, 1,869.

GREENWOOD, a village of Jackson County, central eastern Missouri, on the Missouri Pacific railroad, 25 miles S.W. of Kansas City. Lincoln College (United Presbyterian) is located here. Population, 1900, 230.

GREENWOOD, a village and the capital of Le Flore County, northeastern Mississippi, on the Yazoo River and on the Illinois Central and the Southern railroads, 85 miles N. of Jackson. It is the trade and shipping center for a cotton region, and ships by the river large quantities of this product. Population 1890, 1,055; 1900, 3,026.

GREENWOOD, FRANCIS WILLIAM PITT, an American Unitarian minister; born in Boston, Massachusetts, Feb. 5, 1797; in religious matters, he was a pupil of Dr. James Freeman; graduated at Harvard in 1814; studied theology at Cambridge; began



his ministry in 1818, at the New South Church, Boston; had to leave and travel on account of ill-health; in 1824 he accepted the pastorate of King's Chapel, Boston, first with Dr. Freeman; in 1827, alone. In 1837 his health broke down altogether. He had a strong love for natural science, and devoted much of his time to study and research in that line, contributing frequently to the *Journal of Natural History*. His sermons were extensively read. He published *Sermons of Consolation* (1842); *Sermons to Children* (1841); and other less-known volumes. He died in Dorchester, Massachusetts, Aug. 2, 1843.

GREER, JAMES AUGUSTIN, an American naval officer; born in Cincinnati, Ohio, Feb. 28, 1833; entered the United States navy Jan. 10, 1848; commanded the *Benton* at the passage of the Vicksburg batteries, April 16, 1863, and until the fall of Vicksburg, July 4, 1863, and later, was with the Red River expedition. In 1873 he participated in the *Polaris* search expedition, having command of the *Tigress*. He became captain in 1876; commodore, 1886; rear-admiral, 1893; retired Feb. 28, 1895.

GREG, WILLIAM RATHBONE, an English author; born at Manchester, Eng., 1809; educated at Edinburgh University; entered the public service, became Commissioner of Customs in 1856, and was Comptroller of the Stationery Office in 1864-77; devoted much time to literary criticism and articles on economic and social questions, reviewing severely Mrs. Gaskell's famous labor novel, *Mary Barton*. He wrote *The Creed of Christendom* (1851); *Literary and Social Judgments* (1869); *Enigmas of Life* (1872); *Rocks Ahead* (1874); *Mistaken Aims* (1876); and *Miscellaneous Essays* (1884). Died Nov. 15, 1881.

GREGARINIDEA. See PROTOZOA, Vol. XX, pp. 853-54.

GREGG, ALEXANDER P., an American Episcopal clergyman; born in Society Hills, South Carolina, Oct. 8, 1819; entered the Protestant Episcopal ministry in 1846, and became rector of St. David's Church, Cheraw, South Carolina, in 1847; a trustee and, later, proctor of the University of the South in 1857-59. In 1859 he was elected first bishop of Texas. Died in Galveston, Texas, July 11, 1893.

GREGG, ANDREW, an American statesman; born in Carlisle, Pennsylvania, June 10, 1755, of Irish parents; served in the militia during the Revolution; was tutor in the College of Philadelphia in 1779-83; then, successively, merchant and farmer; became a member of Congress in 1791, and served as such until 1807, from which year until 1813 he was United States Senator from Pennsylvania. In 1816 he was appointed secretary of state of his native state. Died in Bellefonte, Pa., May 20, 1835.

GREGG, DAVID MCMURTRIE, an American general, and a grandson of Andrew Gregg; born at Huntingdon, Pennsylvania, April 10, 1833; graduated at West Point in 1855; served against the Indians in Oregon from 1858 to 1860 as lieutenant; at the outbreak of the Civil War was made captain in the Sixth Cavalry and in January, 1862, was appointed colonel of the Eighth Pennsylvania Cavalry; served with distinction in the Virginia peninsular campaign, and was made brigadier-general of volunteers in 1862. Then he commanded a division

of cavalry, and was engaged at Gettysburg and in the pursuit of Lee's army. After the Richmond campaign, in which he was engaged in command of the Second Cavalry Division, he resigned, Feb. 3, 1865, and was brevetted major-general of volunteers in recognition of his gallant conduct. In 1874 he was appointed United States consul at Prague, Bohemia.

GREGG, JOHN IRVIN, an American soldier; born in Bellefonte, Pennsylvania, July 19, 1826; served through the Mexican War, becoming first lieutenant of the Eleventh Infantry in February, 1847, and captain in the following September. At the commencement of the Civil War he was chosen colonel of the Fifth Pennsylvania Volunteers; in May, 1861, was made captain of the Sixth United States Cavalry; appointed colonel of the Sixteenth Pennsylvania Cavalry in October, 1862, he commanded a cavalry brigade in the army of the Potomac from 1863 till 1865. He was brevetted major-general of volunteers, and brigadier-general of the United States army for distinguished services during the war, and retired in 1879. He died in Washington, D. C., Jan. 6, 1892.

GREGG, MAXCY, a Confederate soldier; born in Columbia, South Carolina, in 1814; graduated at the College of South Carolina in 1836; admitted to the bar in 1839; served as major in the Mexican War in 1847 and 1848; elected to the South Carolina Convention of 1860; member of the committee that recommended secession; colonel of the First South Carolina Volunteers; later, brigadier-general; killed at the battle of Fredericksburg, Virginia, Dec. 13, 1862.

GREGORAS, NICEPHORUS. See BYZANTINE HISTORIANS, Vol. IV, p. 613.

GREGORI, LUIGI, an Italian painter; born in Bologna, Italy, July 8, 1819; studied in Rome and at the academy of his native city, and for several years was engaged in the restoration of old paintings in the Vatican galleries. In 1874 he removed to the United States and was engaged on the capitol at Washington, D. C., and in the decoration of a church at St. Louis, after which he became director of the Art Museum of the University of Notre Dame, Indiana. He remained there for 15 years, during which he produced many fine works, including the series of Columbian paintings that adorn the main hall of the university. In 1891 he returned to Italy.

GREGORIAN CALENDAR. See CALENDAR, Vol. IV, p. 667.

GREGORIAN MUSIC. See MUSIC, Vol. XVII, p. 80.

GREGOROVIVS, FERDINAND ADOLF, a German historian; born at Neidenburg, East Prussia, Jan. 19, 1821; studied theology at Königsberg University in 1838, but soon devoted himself to literature. In 1852 he went to Rome, where he subsequently spent most of his life. His great work is the *History of the City of Rome in the Middle Ages* (8 vols.; 4th ed., 1898). He has written also an Italian geography and a *History of Corsica, Capri and Corfu* (1854), *The Graves of the Popes* (1857; 2d ed., 1881), *Lucrezia Borgia* (1874); *Urban VIII* (1879); *History of Athens During the Middle Ages* (1881); *The Byzantine Empress Athenias* (1882);

*The Death of Tiberius*, a tragedy (1851); and an epic, *Euphorion* (4th ed., 1880). He died in Munich, May 1, 1891.

GREGORY, CAPE, a former name of ARAGO, CAPE, q.v. in these Supplements.

GREGORY, CASPAR RENÉ, an American divine and biblical critic; born in Philadelphia, Nov. 6, 1846; graduated at the University of Pennsylvania in 1864, and at Princeton Theological Seminary in 1870; completed his Ph.D. studies in Leipsic, where he was pastor of the American Chapel from 1878 to 1879, and finally was appointed honorary professor in 1890, after being private tutor there from 1884; assisted in the preparation of Hodge's *Systematic Theology* (1870-73); translated Luthardt's *St. John the Author of the Fourth Gospel* (1875), and *Commentary on St. John's Gospel* (1876-78); and also wrote important pamphlets on Tischendorf's manuscripts. In one of these entitled *Prolegomena*, he gives a description, from his own examination, of all the crucial manuscripts of the New Testament.

GREGORY, DANIEL SEELEY, an American educator; born in Carmel, Putnam County, New York, Aug. 21, 1832; graduated at Princeton in 1857; studied theology, and after holding various pastorates became, in 1871, professor of metaphysics and logic in Wooster University, Ohio, being transferred four years later to the chair of mental science and English literature. In 1879 he became president of Lake Forest University, Illinois. Author of *Christian Ethics* (1875); *Why Four Gospels* (1876); and *Practical Logic* (1881). He was one of the editors of the *Standard Dictionary* (1895).

GREGORY, ROBERT, an English clergyman; born in 1819; graduated at Oxford, 1843; was awarded the Denyer theological prize, Oxford, 1850; curate of Panton, 1847; of Lambeth, 1851; perpetual curate of St. Mary-the-Less, Lambeth, 1853-73; canon of St. Paul's, London, 1868, and treasurer of the cathedral, 1882. He took an active part in philanthropic and educational movements, being elected, in 1873, a member of the London School Board. In 1878 he was appointed a Royal Commissioner to inquire into the Parochial Charities of the city of London, and, in 1886, a Commissioner to inquire into the working of the Education Acts. In 1890 he succeeded Dean Church as dean of St. Paul, and did a great deal toward rendering the cathedral service popular; wrote *Plea for Small Parishes* (1849); *Difficulties and Organization of a Small Metropolitan Parish* (1866); *The Cost of Voluntary Schools and Board Schools* (1875); *Is the Canadian System of Education Rates Possible in England?* (1875); and a number of volumes of sermons, lectures, etc.

GRELL, AUGUST EDUARD, a German composer and organist; born in Berlin, Nov. 6, 1800; a pupil of Zelter; connected with the Berlin Sing-Akademie for over sixty years. His oratorio, *The Israelites in the Desert*, proved a durable success, and was given in New York in 1889. Died Aug. 10, 1886.

GRELLET, STEPHEN, a French divine, known in France as *Étienne de Grellet de Mabillier*; born of noble and wealthy parents, in Limoges, France, Nov. 2, 1773. He was educated at the Military Col-

lege of Lyons, and at the age of 17 entered the body-guard of Louis XVI. During the Revolution he was taken prisoner and sentenced to be shot, but made his escape to Demerara, and in 1795 went to New York. Formerly a Roman Catholic, he now joined the Society of Friends, and, removing to Philadelphia, ministered to the sick during the prevalence of yellow fever in 1798. He returned to New York in the following year, and was for a short time engaged in mercantile pursuits, but soon after devoted himself entirely to missionary work. He made a preaching tour through the Southern and New England states and Canada, and in 1807 went to Europe, where he traveled extensively. Pope Pius VII and Czar Alexander I of Russia listened courteously to his exhortations. Later, he visited Haiti. His biography has been written by Benjamin Seebohm (1868). He died in Burlington, New Jersey, Nov. 16, 1855.

GRENADA, a city and the capital of Grenada County, northern central Mississippi, on the Yallahusha River and on the Illinois Central railroad, 95 miles S. of Memphis, Tennessee. It is the business center of a cotton district, and has flour, lumber, planing and rolling mills. It is the seat of the Grenada Collegiate Institute (Methodist Episcopal South). Population 1890, 2,416; 1900, 2,568.

GRENADE, HAND, a small hollow ball or shell of metal or glass, filled with some explosive material, having a fuse attached, to be thrown by hand into trenches, or upon besiegers scaling a breach. Also, a glass bottle or bulb, filled with a fire-quenching liquid, to be thrown upon incipient fires for the purpose of extinguishing them.

GRENADINES, ISLANDS. See GRENADA, Vol. XI, p. 184.

GRENET'S CELL. See ELECTRICITY, § 103, in these Supplements.

GRESHAM, WALTER QUINTON, American soldier, jurist, and statesman; born near Lanesville, Harrison Co., Ind., March 17,

1832; received a common-school education and but one year at the Indiana State University before he was admitted to the bar in 1853, having studied law, as clerk in a small office, in Corydon, Indiana; was elected to the state legislature in 1860, as a Fremont Republican; resigned to accept a commission in the Thirty-eighth Indiana Volunteers; promoted colonel of the Fifty-third Indiana Regiment, he was severely wounded at Atlanta, and received the brevet of brigadier-general of volunteers for his gallantry before Corinth and Vicksburg in 1863; severely wounded and disabled at Leggett's Hill, he was brevetted major-general of volunteers in 1865; from 1867 to 1868 he was financial agent of the state of Indiana in New York; in 1869 he was appointed United States judge for the district of Indiana by President Grant; in April, 1882, he resigned from the bench to become Postmaster



WALTER Q. GRESHAM.

General under President Arthur, when he so successfully fought the Louisiana Lottery corporation. On the death of Secretary Folger, in July, 1884, he became Secretary of the Treasury, resigning the office in October, 1884, to become United States judge for the seventh circuit, which office he filled with dignity until 1893; in 1892 he declined the nomination as Presidential candidate for the People's party, and gave his full indorsement to the Democratic doctrines as represented by President Cleveland; on the accession of President Cleveland, March, 1893, Judge Gresham became Secretary of State. He proved himself a strong, patriotic head of his high office, notably in the dispute between Nicaragua and Great Britain, in the case of the *Allianza*, and in other grave matters. He died in Washington, District of Columbia, May 28, 1895.

**GRESHAM COLLEGE**, a London institution, of a unique character, wherein lectures are given on the subjects of divinity, law, physics, geometry, astronomy, music and law, but which confers no degrees and has no regular roll of students. It was founded by the generosity of Sir Thomas Gresham, the "Royal Merchant" of Queen Elizabeth, as he is styled in his will. The lectures began in 1597 under the auspices of the Mercers' Company as trustees, and are continued to this day. Parliament removed the clause in the testator's will that the lecturers were not to be married men when appointed and were to lose their position if they married while in office; the lectures are now delivered in English instead of Latin, as formerly. The committee in charge of the Gresham College fund has declared its willingness to co-operate with the management of the University of London, to the best advantage of students.

**GRESHAM'S LAW.** See MONEY, Vol. XVI, p. 731.

**GRETNA**, a town and the capital of Jefferson Parish, southeastern Louisiana, on the Mississippi, opposite New Orleans. It has several railroads, and is connected by ferry with New Orleans. It has a good public-school system. Its principal industry is the making of cotton-seed oil, for which it has three of the largest mills in the United States. In 1868, 1880, 1884 and 1891 the town suffered considerably from crevasses. A wall has been raised in the rear to insure it against the results of breaks above it. Population 1890, 3,332.

**GRETNA GREEN**, a village of Dumfriesshire, Scotland, near the head of the Solway Firth, at one time noted for its clandestine marriages. The Scotch law of marriage simply requiring a mutual declaration of present intention of marriage, it happened that young couples in England, where licenses or bans were required, used to run away to Gretna Green and declare their marriage in the presence of any convenient witness, as a blacksmith, ferryman, toll-keeper or landlord. In 1771 Gretna Green had become "the resort of all amorous couples whose union the prudence of parents or guardians prohibits," and 200 couples were sometimes united in a twelvemonth. Statute 19 and 20, Vict. c. 96, destroyed the business by requiring one of the parties to an irregular marriage in Scotland to be a res-

ident of that kingdom for 21 days previous to the ceremony.

**GREVILLE**, HENRY, the pen-name of DURAND, ALICE MARY CÉLESTE, q.v., in these Supplements.

**GRÉVY**, FRANÇOIS PAUL JULES, a French statesman and ex-President of the French Republic; born at Mont-sous-Vaudrey, Jura, Aug. 15, 1807. He studied at the Collège Poligny, and afterward took a law course in Paris, being admitted as a lawyer in 1837. In 1830, while a student, he took part in the "Revolution of the three days of July." In 1848 he was appointed commissary to the Department of Jura, and shortly after returned as its deputy to the National Assembly, where, although not an



FRANÇOIS P. J. GRÉVY.

ultra-radical, he took his seat on the Left. After Louis Napoleon's *coup d'état*, Grévy retired from public life and devoted himself to his law practice until 1868, when he was again elected to the Chamber from Jura. Here he proved a strong enemy to the empire. In 1871 he was again returned and was elected president of the Assembly, which office he held until 1873. In 1876 he was again elected president of the Assembly, and upon the resignation of MacMahon in 1879, was chosen President of the Republic for seven years, and when his term expired in 1886 was re-elected. Up to this time he had enjoyed great personal popularity, his firmness, impartiality and honesty having kept him in office amid many changes of parties and fluctuations of public opinion; but finally he allowed his son-in-law, Wilson, to gain too great an influence over him; the latter abused his confidence, and in 1887 was adjudged guilty of the sale of public offices. Although Grévy was in no way implicated in these frauds, public indignation forced his retirement. He resigned Dec. 3, 1887, and died Sept. 9, 1891, at Mont-sous-Vaudrey.

**GREWIA**, a genus of East Indian tiliaceous trees, yielding good bast for rope-making, etc. Some yield timber, and the leaves of others are used as fodder.

**GREY**, ALBERT HENRY GEORGE, FOURTH EARL, a British nobleman; born in 1851; succeeded his uncle in 1894. He was Member of Parliament from Northumberland from 1880 to 1885. He traveled much in Africa, became connected with Cecil Rhodes's British South Africa Chartered Company, and on Feb. 21, 1896, after the recall of Dr. Jameson on account of his raid into the territory of the South African Republic, was appointed co-administrator of the company with Cecil Rhodes, and representative of the Colonial Office in South Africa.

**GREY**, SIR GEORGE, a British colonial governor; born at Lisburn, Ireland, in 1812. He was educated at the Royal Military College at Sandhurst, entered the army and became captain in 1835; four years

later retired and accompanied an exploring expedition to the interior of Australia. In 1841-45 he was governor of South Australia, and in 1845-54 of New Zealand, his conciliatory rule doing much toward reconciling the natives to British control. In 1854-61 he was governor of the Cape of Good Hope, and allayed the irritation left by the Kaffir war; and in 1861 he was reappointed governor of New Zealand to quell the insurrection then in progress. In 1872 he retired; in 1875, became superintendent of the province of West Auckland; in 1877-84 Premier of New Zealand. He published *Journals of Discovery in Australia* (1841) and *Polynesian Mythology and Traditions of New Zealand* (1855). Died in London, Sept. 19, 1898.

GREYHOUND. See DOG, Vol. VII, pp. 327-28.

GREYLOCK, MOUNT, 3,600 feet high, is the chief eminence of the Greylock Range, in Berkshire Co., Mass., and the highest point of land in the state. Its sides are covered with forests.

GRIDLEY, CHARLES VERNON, American naval officer, was born at Logansport, Ind., in 1845. He was made commander March 10, 1882; and captain March 14, 1897. When the war with Spain broke out in April, 1898, he was captain of the *Olympia*, Commodore Dewey's flagship, and though he was in bad health, he bravely took part in the battle in Manila Bay, May 1, 1898, and shared in the honors of that brilliant victory over the Spanish fleet. He died on board the steamship *Coptic*, near Kobe, Japan, June 4, 1898, of injury received through over-exertion in the battle.

GRIEG, EDVARD HAGERUP, a Norwegian composer; born at Bergen, Norway, June 15, 1843. In 1858 he went to the Conservatorium, at Leipsic, and studied under Hauptmann, Richter, and other masters; then went to Copenhagen and afterward to Christiania, where he taught music for eight years. The Norwegian Parliament gave him a pension to enable him to devote himself to composition. His works, with a few exceptions, are for the pianoforte, and possess marked originality and the characteristics peculiar to Norwegian music. Among them are *Humoresken*, *Sigurd Jorsalafar*, and *Peer Gynt*.

GRIER, WILLIAM MOFFATT, an American educator; born in York Co., S. C., Feb. 11, 1843; graduated at Erskine College in 1860, and in 1871, after four years in the ministry, became president of his *alma mater* and professor of Greek exegesis and homiletics at Erskine Theological Seminary. He edited *The Associate Reformed Presbyterian*.

GRIERSON, BENJAMIN HENRY, an American soldier and explorer; born in Pittsburg, Pa., July 8, 1826; at an early age removed to Ohio, and was afterward engaged in business at Jacksonville, Ill. At the beginning of the Civil War he served on the staff of General Prentiss; in August, 1861, was made major of the Sixth Illinois Cavalry; became colonel in the following spring; brigadier-general of volunteers in June, 1863; major-general in May, 1865; colonel of the Tenth United States Cavalry in July, 1866, and in March, 1867, was brevetted brigadier and major-general United States army. He commanded the district of the Indian Territory, 1868-73; was engaged in exploring parts of New

Mexico and Texas, 1875-84; and in 1886 was placed in command of the district of New Mexico.

GRIFFIN, a city and summer resort, the capital of Spalding Co., Ga., 40 miles S. of Atlanta. Cotton furnishes the chief industry, and there are furniture and carriage factories. The surrounding country is devoted to the raising of cotton and fruit, especially grapes and peaches, and wine-making. There is a mineral spring here. The State Agricultural Experiment Station and the State Military Encampment are located here. Pop. 1890, 4,503.

GRIFFIN, CHARLES, an American soldier; born in Licking County, Ohio, in 1826; graduated at the United States Military Academy in 1847; entered the army as brevet second lieutenant of artillery and served during the Mexican War; in June, 1849, made first lieutenant; was instructor of artillery at West Point in 1850-61; commanded the West Point Battery at Bull Run, and was brevetted major for gallant conduct; in June, 1862, was commissioned brigadier-general of volunteers; commanded a brigade in the Virginia peninsula campaign, winning distinction at Yorktown, Gaines's Mill and Malvern Hill, was promoted to the command of a division and engaged in the battles of Antietam and Fredericksburg; as commander of the Fifth Corps, under General Grant, was one of the commissioners to carry out the terms of the surrender of General Lee at Appomattox Courthouse. In May, 1865, General Griffin was brevetted brigadier and major-general in the regular army; was assigned to the command of the district of Maine in the August following; in July, 1866, was made colonel of the Thirty-fifth Infantry, and commanded military districts in Texas and Louisiana. He died in Galveston, Texas, Sept. 15, 1867.

GRIFFIN, EDWARD DORR, an American educator; born in East Haddam, Connecticut, Jan. 6, 1770. He graduated at Yale in 1790; studied theology; and in 1795 became pastor of the Congregational Church at New Hartford, afterward holding pastorates at Newark, New Jersey, and Boston, Massachusetts. He was professor of rhetoric in Andover Theological Seminary from 1809 to 1811, and president of Williams College from 1821 to 1836. He published *Course of Lectures in Park Street Church* (1813). He died in Newark, New Jersey, Nov. 8, 1837.

GRIFFIS, WILLIAM ELLIOT, an American author; born in Philadelphia, Pennsylvania, Sept. 17, 1843; served during a part of the Civil War in the Forty-fourth Pennsylvania Volunteers; entered Rutgers College, graduating in 1869; studied theology at the New Brunswick Theological Seminary for two years; in 1870 went to Japan, under an appointment from the Japanese government, to organize schools on the American plan; made superintendent of schools in the province of Echizen, Japan, in 1871; professor of physics and chemistry at the Imperial University of Tokio from 1872 to 1874. Upon his return to the United States he continued his theological studies at the Union Theological Seminary in New York City; graduated in 1877, and, until 1886, was pastor of the First Reformed Dutch Church at Schenectady, New York; afterward, until 1892, of the Shaw-

mut Church in Boston; in 1893, of a Congregational Church at Ithaca, New York. Dr. Griffiths published *The Mikado's Empire* (1876); *Japanese Fairy World* (1880); *Corea: The Hermit Nation* (1882); *Corea Without and Within* (1885); *Matthew Calbraith Perry* (1887); *Japan in History, Folk-Lore and Art* (1892); *Life of Townsend Harris* (1895). He was an authority on Japan and Korea.

GRIFFITHS, JOHN WILLIS, an American naval architect; born in New York City, Oct. 6, 1809. Early apprenticed to a shipwright, at nineteen years of age he laid the lines of the frigate *Macedonia*. He suggested the clipper model of the fast ships built for the China trade; and in 1853, began the construction of a steamer which, when completed, made the fastest time on record between Havana and New Orleans. In 1858 he was appointed by the government special naval constructor to build the gunboat *Pawnee*, and in 1872 built the United States ship *Enterprise*. Mr. Griffiths was the originator of the idea of lifeboat steamers, the inventor of a timber-bending machine, iron keelsons for wooden ships, bilge-keels to prevent rolling, triple screws for great speed, and improved rivets. He died in Brooklyn, New York, April 29, 1892.

GRIFFITH'S VALUATION. See HOME RULE, in these Supplements.

GRIGGSVILLE, a city of Pike County, central western Illinois, 4 miles W. of the Illinois River, and 48 miles S.E. of Quincy, on the Wabash railroad. It has manufactories of farming implements, carriages and flour, and a public library. Population 1890, 1,400; 1900, 1,404.

GRIGORIOPOL, a town of Kherson, south Russia, on the left bank of the Dniester, 82 miles N.W. of Odessa. Its 7,918 inhabitants, mostly Armenians, cultivate tobacco, wine and fruit.

GRIGSBY, HUGH BLAIR, an American writer; born in Norfolk, Virginia, Nov. 22, 1806; represented his native county in the legislature and state convention of 1829-30, and devoted himself to literature. In 1871 he became chancellor of William and Mary College. He wrote a *Discourse on the Virginia Convention of 1776*. He died April 28, 1881.

GRIJALVA RIVER. See TABASCO RIVER, in these Supplements.

GRILLO, MARQUISE DEL (ADELAIDE RISTORI), an Italian actress; born at Cividale, Friuli, in 1821. Her parents were comedians and poor, and at four she was put upon the stage. She attained local distinction at Parma and Leghorn, and in 1847 married the Marquis del Grillo, retiring from the stage. During the siege of Rome she nursed in the hospitals. She returned to the stage in 1850, and in 1855 made her Parisian *début* with great success, although Rachel was at that time the idol of Paris. Later, she went to England, Spain, Russia, and in 1866 to the United States and South America. She made a second tour to America in 1874, and a third in 1884. Among her favorite rôles were those of Medea, Phædra, Deborah, Camilla, Francesca da Rimini and Lady Macbeth. She published *Études et Souvenirs* (1887).

GRILSE. See SALMONIDÆ, Vol. XXI, p. 224.

GRIMALDI, JOSEPH, an English pantomimist;

born in London, of a family of clowns, Dec. 18, 1779; began to act in pantomime when a child; won his reputation at Covent Garden, in 1806, in *Mother Goose*; made his last appearance June 27, 1828, as Harlequin. His health failed and he died in poverty in London, May 31, 1837. The pantomime is said to have died with him. In 1838 Charles Dickens edited his memoirs, the authority for the facts of Grimaldi's life.

GRIMES, JAMES WILSON, an American statesman; born in Deering, Hillsboro County, New Hampshire, Oct. 20, 1816; graduated at Dartmouth College in 1836; settled in the practice of law at Burlington, in the "Black Hawk Purchase," now Iowa; was a delegate to the territorial legislature of Iowa in 1838 and 1843; in 1852 a member of the state legislature; governor of the state in 1854; elected to the United States Senate, as a Republican, in 1859; was a delegate to the peace convention in 1861, and in 1865 was re-elected to the Senate; resigned in 1869, on account of failing health. As governor, Grimes promoted the extension of railroads in his state and espoused the Free-Soil movement, being one of the founders of the Republican party. In the Senate he was noted for his independence, and in 1861 came into conflict with his party in opposing Lincoln's increase of the regular army, and by voting to acquit President Johnson. As a member of the Committee on Naval Affairs, he was among the first to propose the use of ironclad vessels. He died in Burlington, Iowa, Feb. 7, 1872.

GRIMKÉ, SARAH MOORE, an American abolitionist; born in Charleston, South Carolina, Nov. 6, 1792. Becoming convinced of the evils of slavery, she freed her slaves in 1836, and went to Philadelphia and began writing and lecturing against that institution. Later she became a teacher in the schools of her sister, Angelina Weld. She published *An Epistle to the Clergy of the Southern States* (1827); *Letters on the Condition of Woman and the Equality of the Sexes* (1838); and a translation of Lamartine's *Joan of Arc* (1867). She died in Hyde Park, Massachusetts, Dec. 23, 1873.

GRIMKÉ, THOMAS SMITH, an American lawyer and politician; born at Charleston, South Carolina, Sept. 26, 1786; graduated at Yale College in 1807 and studied law in Charleston; member of the state senate from 1826 to 1830. In 1828 he made a speech in favor of the general government on the tariff question. He was one of the first advocates of the temperance cause and a member of the Peace Society. He published, in 1831, *Addresses on Science, Education and Literature*. He died near Columbus, Ohio, Oct. 11, 1834.

GRIMM, CONSTANTIN V., BARON DE, a German caricaturist; born Dec. 30, 1845, at St. Petersburg. He attended school in St. Petersburg until 1860 and completed his education in Dresden and Berlin. He entered the German army in 1867 as lieutenant in the Emperor's regiment, and retained his commission until 1873, when he resigned to accept the position of assistant editor of the Berlin *Kladderadatsch*. In the following year he became editor of *Puck*, a humorous paper of Leipsic. In 1884 he went to America and did work on several of the

New York papers. He died in New York, April 16, 1896.

GRIMM'S LAW. See GRIMM, Vol. XI, p. 200.

GRIMSHAW, ROBERT, an American physicist and writer; born in Philadelphia, Pennsylvania, Jan. 25, 1850; educated in Andalusia, Pennsylvania, and abroad; professor in Andalusia College; lecturer on physics in the Franklin Institute of Philadelphia. Published *The Steam-Engine Catechism* (1885-87); *The Pump Catechism* (1887); *Steam-Boiler Catechism* (1888); and was one of the editors of the *Iconographic Encyclopedia* and of the *Standard Dictionary*.

GRIMSTON, MARGARET (ROBERTSON), better known as MADGE KENDAL, an English actress; born at Great Grimsby, England, March 15, 1849. When four years old she appeared at the Marylebone Theatre, London, and in July, 1865, made her *début* as Ophelia at the Haymarket, as "Madge Robertson." On Aug. 7, 1869, she married William Hunter Grimston, who was acting under the name of "Kendal," and became known as Mrs. Kendal. With Mr. Kendal she made profitable tours to America in 1889, 1891, 1893 and 1895. Among others, she played rôles in *Diplomacy*; *The Iron-Master*; and *A Scrap of Paper*. During the last few years she appeared mostly in *The Second Mrs. Tanqueray*, which was criticised severely from a moral standpoint.

GRIMSTON, WILLIAM HUNTER, an English actor; born in London, Dec. 16, 1843. As an actor he is known as W. H. Kendal. He was intended for a mercantile career, but turned to the dramatic profession. His first appearance in London was at the Haymarket, in *A Dangerous Friend* (1866), after which time he appeared at the same place in numerous old comedies. In 1869 he married Margaret Robertson (q.v., above), after which the couple played in the same companies. One of his best rôles is that of Captain Beauclerc in Sardou's *Diplomacy*; he is also well known in the parts of Captain Absolute and Charles Surface.

GRIMTHORPE, EDMUND BECKETT DENISON, BARON, an English author; born at Carlton Hall, Nottinghamshire, May 12, 1816; educated at Trinity College, Cambridge; called to the bar in 1841; in 1887, appointed chancellor and vicar-general of York; in 1886, created peer. Author of *Lectures on Gothic Architecture* (1855); *Lectures on Church-Building* (1856); *Life of John Lonsdale* (1868); and *A Review of Hume and Huxley on Miracles* (1883).

GRINDELWALD, a town of southwestern Bern Canton, Switzerland, on the Black Lüttschine; beautifully situated in the valley of that name, 7 miles S.S.E. of the Lake of Thun. The valley is 15 miles long, 2 broad, and 3,852 feet above sea level. It is surrounded by the giants of the Bernese Alps, the Eiger (13,041 feet), the Schreckhorn, the Faulhorn and the Wengern Alp. Kirschwasser is manufactured here, and the place is a favorite tourist resort. Population, 3,089.

GRINDING AND CRUSHING MACHINERY. See GOLD, Vol. X, pp. 747, 748; and MINING, Vol. XVI, pp. 463, 464.

GRINDSTONE ISLAND, an island of Albert County, southeastern New Brunswick, at the head of the Bay of Fundy. Sandstone of very fine grain is

quarried, and is shipped, mostly to the United States, for the manufacture of grindstones. The island has a lighthouse.

GRINDSTONE ISLAND, one of the most important of the Magdalen Islands, situated in the Gulf of St. Lawrence, northeast of Prince Edward Island. Area, 13,700.

GRINNELL, a city of Poweshiek County, eastern central Iowa, 47 miles E. of Des Moines. It has a foundry, flour-mills, carriages and wagons, and wood-work factories, and a machine-shop and a glove factory. It is surrounded by an agricultural and wool-growing region. Grinnell University, founded here by Josiah Bushnell Grinnell in 1854, was consolidated later with Iowa College, the site of which is in this town. Population 1900, 3,860.

GRINNELL, HENRY, an American merchant; born in New Bedford, Massachusetts, Feb. 13, 1799; graduated at the academy in his native place in 1818, and became a clerk in a commission house in New York; in 1825, partner in the firm of Grinnell, Minturn and Company; retired from business in 1852. In 1850 he fitted out two vessels and dispatched them, under the command of Lieutenant De Haven, to search for Sir John Franklin. No trace of Franklin was found, but land in lat. 80° N. was discovered, and named Grinnell Land (q.v., in these Supplements). A second expedition for the same purpose, under Dr. Kane, was fitted out in 1853, by Grinnell and George Peabody. Mr. Grinnell contributed also to the expedition of Dr. Hayes and to Hall's *Polaris* expedition in 1871. He was the first president of the American Geographical Society (1852-53). He died in New York City, June 30, 1874.—His brother, MOSES HICKS GRINNELL, was born in New Bedford, Massachusetts, March 3, 1803; in 1818, entered a New York counting-house; became a member of the firm of Fish and Grinnell in 1825; member of Congress from 1839 to 1841; collector of the port of New York in 1869-70; president of the New York Chamber of Commerce in 1843. He contributed toward Dr. Kane's Arctic expedition of 1853. He died in New York City, Nov. 24, 1877.

GRINNELL LAND, a barren, mountainous tract, between lat. 80° and 83° N., on the west side of Kennedy Channel, the northern continuation of Smith's Sound. It was discovered by the expedition under Lieutenant De Haven in 1850, and named after Henry Grinnell of New York, who had fitted out the expedition. It was explored and mapped by Dr. Hayes in 1854, and more thoroughly explored by Greely in 1882. North and south it is covered with ice-caps; between them lie valleys, free of snow in summer, which support herds of musk-oxen and the usual Arctic fauna. In the interior is Lake Hazen, 65 miles long, and two ranges of mountains, one containing a peak, Mount Arthur, 5,000 feet high.

GRIPPE, LA. See INFLUENZA, Vol. XIII, p. 73.

GRIQUALAND, WEST. See GRIQUALAND, WEST, Vol. XI, pp. 204, 205; and AFRICA, in these Supplements.

GRIQUAS, a South African race of half-castes, the offspring of Hottentot and Bushwomen by colonists of Dutch descent. They form a distinct

community in the region known as Griqualand, annexed to Cape Colony in 1871. Many of the Griquas are civilized, have adopted the Christian religion, and are successful agriculturists and cattle-breeders. See also CAPE COLONY, Vol. V, p. 47.

GRISCOM, JOHN, an American educator; born at Hancock's Bridge, Salem County, New Jersey, Sept. 27, 1774; principal of the Friends' monthly meeting school in Philadelphia for 13 years; teacher in New York for 25 years; in 1812, appointed professor of chemistry and natural history at Rutgers College; founder of the New York High School, which was under his supervision from 1825 to 1831; principal of the Friends' school at Providence, Rhode Island, from 1832 to 1834. Griscom was one of the first to teach chemistry. He published *A Year in Europe* and *Monitorial Instruction*. A *Memoir of John Griscom* was published by his son (1859). He died in Burlington, New Jersey, Feb. 26, 1852.

GRISCOM, JOHN HASKINS, an American physician and author; born in New York City, Aug. 14, 1809. He graduated in the medical department of the University of Pennsylvania in 1832; was professor of chemistry in the New York College of Pharmacy from 1836 to 1840, and in 1843 became visiting physician of the New York Hospital. Author of *Animal Mechanism and Physiology* (1839); *Uses and Abuses of Air for the Ventilation of Buildings* (1850); *Prison Hygiene* (1868); and other works. He died in New York City, April 28, 1874.

GRISEBACH, AUGUST HEINRICH RUDOLPH, a German botanist; born in Hanover in 1814. He studied botany and medicine at Göttingen and Berlin; was employed by the government of Hanover, in 1839, to study the flora of Turkey; in 1841 was appointed professor of botany at Göttingen and director of the botanical garden. He published *Reise nach Rumelien und Brussa* (2 vols., 1841); *Spicilegium Floræ Rumeliceæ* (2 vols., 1843-45); and *Die Vegetationslinien des Nordwestlichen Deutschlands* (1846); etc. He died May 9, 1879.

GRISI, GIULIA, an Italian prima donna; born in Milan, in May 22, 1812; studied at Milan and Bologna; made her first appearance at Bologna, as Emma, in Rossini's *Zelmira*, in 1828; made her Parisian *début* in 1832; two years later appeared in London; in 1836 married Gérard de Melcy, and afterward Signor Mario, the tenor. In 1854 she visited America with her husband, and afterward made her home in England. From the first, Grisi won distinction and admiration by the rare melody and sweetness of her voice, a pure, brilliant, powerful soprano, and by her personal grace and beauty, her admirers lavishing upon her extravagant praise, such as "The Singing Flower of Beauty," an expression of Heine, and the enthusiastic declaration that "She possessed the lost arms of the Venus of Milo." Though at first she had to struggle against defects of voice, she finally overcame them. Her favorite rôles were *Norma*, *I Puritani* (written for her), and *Don Pasquale*. She died in Berlin, Nov. 29, 1869.

GRIS-NEZ CAPE, a headland in the French department of Pas-de-Calais, opposite Dover, and the point of land nearest to the English shore, the

distance being barely twenty miles. About equally distant from Calais, on the northeast, and Boulogne, on the south, the cape marks the dividing line between the North Sea and the English Channel. It is surmounted by a lighthouse.

GRISWOLD, FORT, a Revolutionary fortification on the heights of Groton, across the Thames from New London, Connecticut, and the scene of a ruthless massacre of American troops by Benedict Arnold, during the attempt of Clinton to divert Washington from the siege of Yorktown. The place was garrisoned with 157 men. Arnold attacked it, Sept. 6, 1781, with a force of 600, and, after losing 192 of his men, forced it to surrender. He thereupon slaughtered the entire garrison, with the exception of 26, who escaped. The site of the old fort is occupied now by an earthwork with a small battery, and not far away stands a shaft, 127 feet high, commemorating the victims of the massacre.

GRISWOLD, ALEXANDER VIETS, an American clergyman and author; born in Simsbury, Connecticut, April 22, 1766. He studied law, but, disliking the profession, prepared for the ministry, and was ordained in 1795. He had charge successively of parishes in Plymouth, Harwinton and Litchfield, Connecticut, and in 1804 accepted a call to the rectorship of St. Michael's Church, Bristol, Rhode Island. In 1811 he was consecrated as the first bishop of the eastern diocese of the Protestant Episcopal Church. He published *Discourses on the Most Important Doctrines and Duties of the Christian Religion* (1830) and *The Reformation and the Apostolic Office* (1843). The *Life of Bishop Griswold* has been written by J. S. Stone (1844). He died in Boston, Feb. 15, 1843.

GRISWOLD, JOHN A., an American manufacturer; born in Rensselaer County, New York, Nov. 11, 1818; went to Troy and became interested in the Rensselaer Iron Company, of which he was later a partner; mayor of Troy in 1850; elected to Congress in 1862, and twice re-elected; trustee of the Rensselaer Polytechnic Institute from 1860 to 1872. During the Civil War he aided in raising three regiments of infantry and the "Griswold Light Cavalry" of the Twenty-first New York. He was one of the contractors to build Ericsson's *Monitor*. As a member of the House Committee on Naval Affairs, he urged building other monitors by the government. He died in Troy, New York, Oct. 31, 1872.

GRISWOLD, RUFUS WILMOT, an American author; born at Benson, Vermont, Feb. 15, 1815. In early life he traveled in the United States and central and southern Europe; was apprenticed to a publisher, but, tiring of the business, studied theology and became a Baptist minister. Leaving the ministry for journalism, he edited *Graham's Magazine*, in Philadelphia, from 1841 to 1843; in 1852 became editor of the *International Magazine*. His works include *Poets and Poetry of America* (1842); *Poets and Poetry of England in the Nineteenth Century* (1845); *Washington and the Generals of the Revolution*, in connection with other writers (1847); *Female Poets of America* (1848); *Sacred Poets of England and America* (1849); and a number of other works. He also compiled *Curiosities of American Literature*; ed-

ited the first American edition of Milton's prose works, and was one of the editors of the works of Edgar A. Poe, writing the introductory sketch which was criticised so severely. He died in New York City, Aug. 27, 1857.

GRÖBER, GUSTAV, a German philologist; born in Leipsic, May 4, 1844; private instructor at Zurich in 1869; professor of Romance philology at Breslau in 1874; in 1882 professor at Strasburg University. In 1876 he founded and edited the *Magazine of Romance Philology*, and was editor of the *Outline of Romance Philology* (1888).

GROLIER CLUB, a New York club for bibliophiles, organized in 1884, and consisting of 250 members. It possesses a handsome clubhouse at 29 East Twenty-second Street, and a fine library of rare books in valuable bindings.

GROLIER DE SERVIÈRES, JEAN, a French bibliophile; born at Lyons in 1479; died in Paris, 1565. He was attached to the court of Francis I; went to Italy as intendant-general of the army, and French ambassador to Rome. He returned to Paris, became the treasurer of Francis I and turned his attention to collecting books and medals. At the time of his death his collection of the former numbered three thousand, many of which were printed or bound especially for him. The library was broken up and sold in 1675, and only about three hundred and fifty are now extant; these sell for from one hundred and twenty dollars to two hundred and forty dollars apiece, and are much sought by book-collectors. His entire collection of medals was purchased by Louis XIV. See BOOKBINDING, Vol. IV, p. 41.

GROOTE EYLANDT (Dutch, "Great Island"), an uninhabited island on the west side of the Gulf of Carpentaria, in North Australia. It is surrounded by reefs, and its interior is hilly. In extreme length and breadth it measures about 40 miles each way.

GROSS, SAMUEL DAVID, an American professor of surgery; born near Easton, Pennsylvania, July 8, 1805. He graduated at Jefferson Medical College in 1828; in 1835 became professor of pathological anatomy in the Cincinnati Medical College, Ohio; in 1840 professor of surgery in the University of Louisville, Kentucky; and in 1850 was chosen Dr. Mott's successor in the University of New York. Six years later he became professor of surgery in Jefferson Medical College, Philadelphia, which position he held until within two years of his death. He was president of the American Medical Association in 1867, and of the International Medical Congress in Philadelphia in 1876. He published *A System of Surgery* and *Pathological Anatomy*. He died in Philadelphia, May 6, 1884.



SAMUEL D. GROSS.

GROSSE-ISLE. See QUEBEC, Vol. XX, p. 167.

GROSSULARITE. See GARNET, Vol. X, p. 82.  
GROSVENTRE INDIANS. See INDIANS, AMERICAN, Vol. XII, p. 832.

GROTON, a village of New London County, southeastern Connecticut, on the Thames River, opposite New London, on Long Island Sound, and on the New York, New Haven and Hartford railroad. Fort Griswold is located here, on the same spot as old Fort Griswold. It is a fishing resort, and is the residence of numerous New London merchants. It has cotton-mills, manufactories of Britannia-ware and carriages, and two granite quarries. Population 1890, 5,539; 1900, 5,962.

GROTON, a village of Tompkins County, southwestern central New York, on the Lehigh Valley railroad, 25 miles S. of Auburn. It is in a farming and dairying district, has manufactories of iron bridges, carriages, farming implements and type-writing machines, and a large cooorage. Population 1890, 1,280. 1900, 1,344.

GROTTA DEL CANE. See AGNANO, LAGO D', Vol. I, p. 283.

GROUCHY, EMMANUEL, a French general; born in Paris, Oct. 23, 1766. He entered the army when fourteen; at the outbreak of the Revolution was colonel of cavalry; fought in the suppression of the revolt in La Vendée, and in 1798, under Moreau, in Italy; taken prisoner and exchanged in 1799; fought at Hohenlinden, Eylau, Friedland and Wagram, and commanded the body-guard of Napoleon in the retreat from Moscow. He was banished in 1814, but returned in 1815 and joined Napoleon upon his return from Elba. Grouchy has been severely criticised for his action at the time of the battle of Waterloo, and charged with deserting Napoleon. The usual explanation of his conduct is that he adhered too literally to Napoleon's orders. On June 16, 1815, Napoleon attacked the Prussians at Ligny, defeated them and forced them to retreat. Grouchy was now sent with 33,000 men to follow them, moving, according to his orders, toward Namur. Blücher advanced his main force toward Wavre, and finally was able to join Wellington, leaving Grouchy to fight a Prussian corps under Thielemann. When the cannon at Waterloo was heard, Grouchy's subordinates begged him to move in that direction, but he refused to disobey his orders. When other commands came, it was too late. After the battle he was banished, came to America, and lived in Philadelphia for six years, until, in 1821, he was allowed to return by royal ordinance. In 1832 he was created peer and allowed the title of marshal. He lived in France until his death, which occurred at St. Étienne, May 29, 1847.

GROUND-DOVE, a popular name for those pigeons or doves which seldom fly, but spend most of the time upon the ground. They are usually rapid runners. Several birds of the genus *Chamaepelia*, found in the United States, are given the name. The Australian bronze-wing is a ground-dove.

GROUND-FINCH. See CHEWINK, in these Supplements.



**GROUND-HOG.** See **WOODCHUCK**, in these Supplements.

**GROUND-IVY** (*Nepeta Glechoma*), a plant of the family *Labiatae*, a native of Britain and other parts of Europe, and naturalized in America. It has a creeping stem, kidney-shaped crenate leaves and axillary blue flowers. A tea prepared from the leaves is in great repute among the poor in many places, and the plant is supposed to be stimulant, aromatic and of use in pectoral complaints. The leaves were used in England formerly for clarifying and flavoring ale. It is also known in the United States as gill-over-the-ground, and is one of the earliest bloomers in waste or cultivated shaded grounds. *V. Cataria*, of the same genus, is the well-known catnip.

**GROUNDLING** (*Cobitis taenia*), a small cyprinoid fish, allied to the loach, but differentiated by the presence of an erectile, divided spine situated under the eye, and by its more compressed form. It is rarely found, frequenting the muddy bottoms of rivers in Britain, and the genus is limited to a few species.

**GROUND-PARRAKEET**, a small Australian parrot of the genus *Pezoporus*, to which the popular name *parrakeet* is given because of the long, wedge-shape tail. The bird spends most of the time on the ground.

**GROUND-PINE** OR **CLUB-MOSS**. See **LYCOPodium**, Vol. XV, pp. 94, 95.

**GROUND-RENT**. See **RENT**, Vol. XX, p. 403.

**GROUND-SQUIRREL**, the popular name of a burrowing rodent of the genus *Tamias*. It is also known as "chipmunk." The American species are identical with those of the Old World. The fur is yellow, with dark, longitudinal stripes. In cultivated regions they are great pests. The North American species of *Spermophilus*, which resemble *Tamias* in appearance and habits, sometimes are called ground-squirrels.

**GROUPEr**, the common name of fishes belonging to the genus *Epinephelus*, found principally in the warmer American seas. The red-grouper (*E. morio*) of our Southern coasts is a valuable food-fish, and sometimes reaches a weight of forty pounds. The name *black-grouper* is sometimes applied to the related jew-fish (q.v., in these Supplements).

**GROVE, SIR GEORGE**, an English civil engineer and author; born in 1820. He was trained as an engineer, and erected, in the West Indies, the first two cast-iron lighthouses built; was employed on the Chester General Station and the Britannia Tubular Bridge; from 1850 to 1852 was secretary of the Society of Arts; secretary of the Crystal Palace Company from 1852 to 1873; knighted in 1883, on the opening of the Royal College of Music, Kensington Gore, of which he was made director by the Prince of Wales. He assisted Dean Stanley in some of his works on the Bible and the East; was one of the founders of the Palestine Exploration Fund, an editor of *Macmillan's Magazine*, a contributor to *Smith's Dictionary of the Bible*, and the editor of the *Dictionary of Music and Musicians*. He died May 28, 1900.

**GROVE, SIR WILLIAM ROBERT**, an eminent English jurist and man of science, was born at Swansea, South Wales, July 11, 1811, and died in London in his eighty-sixth year. He graduated from Brasenose College, Oxford, in 1830, and five years later was called to the bar at Lincoln's Inn. Ill health for a time prevented him from actively pursuing his profession; meanwhile, he turned his attention to electrical researches, and in 1839 contrived the powerful voltaic battery which bears his name. From 1840 to 1847 he was professor of experimental philosophy at the London institution, during which period he laid the foundation of the European reputation in the world of physical investigation which he subsequently acquired. Resuming his profession, he became a successful lawyer, and in 1871 was created a judge of the Common Pleas, and four years later became a judge of the High Court of Justice. He retired from the bench in 1887 after 16 years' service, was knighted and sworn a member of the Privy Council. Sir William made several important discoveries in electricity and optics, and in 1842 he delivered a remarkable lecture on *The Progress of Physical Science*. In this paper he first advanced the doctrine of the mutual convertibility of the various natural forces—heat, electricity, etc.—and of their being all modes of motion or forms of persistent force. This doctrine he developed in his now well-known work *On the Correlation of Physical Forces* (1846) and in *Voltaic Ignition* (1847). He died in London, Aug. 2, 1896.

**GROVES, CHARLES EDWARD**, an English chemist; born at Highgate, March 4, 1841. He studied at the College, Brixton Hill, and at the Royal College of Chemists; in 1862 appointed lecturer on practical chemistry at Guy's Hospital; in 1885 consulting chemist to the Conservators of the River Thames; in 1878 joined the staff of the *Journal of the Chemical Society*; in 1884 became editor of that paper. He has edited volumes 2 and 3 of *Miller's Chemistry* (the former with Dr. Armstrong); *Grove's and Thorp's Chemical Technology* (vol. 1, 1889). He discovered the compounds tetra-bromide of carbon, Beta naphtha quinone, and the corresponding diquinone.

**GROVE'S CELL**. See **ELECTRICITY**, § 101, in these Supplements.

**GROW, GALUSHA A.**, an American lawyer and statesman; born at Ashford, Windham County, Connecticut, Aug. 31, 1824; graduated at Amherst College in 1844; studied law, and was admitted to the bar in 1847; member of Congress from Pennsylvania in 1851, and represented his district for twelve successive years. First elected as a Democrat, he severed his connection with that



GALUSHA A. GROW.

party on the repeal of the Missouri Compromise in 1854. In 1861-63 he was Speaker of the House. He was delegate to the National Republican conventions of 1864 and 1868, and elected Congressman-at-Large from Pennsylvania, in February, 1894.

GROWLER OR GRUNT, a popular name applied to several fishes, which make a peculiar noise when drawn out of the water. The name is usually given to species of *Hemulon*. These are excellent food-fishes, found in American waters. An allied genus, *Orthopristis*, found along the southern American coast, sometimes is called by above names.

GROWTH, ANIMAL. See NUTRITION, Vol. XVII, pp. 686, 687. For vegetable growth, see PHYSIOLOGY, Vol. XIX, pp. 57-60.

GRUB, the name properly applied to the worm-like larvæ of insects of the coleopterous or beetle order, loosely given to the larvæ of other insects. Thus the disease affecting sheep called "grubs in the head" is caused by the deposit of eggs of the gad-fly (a dipterous insect) in nostrils of sheep. The eggs are hatched, and the maggots or grubs attach themselves to the mucous membrane, remaining there till the following spring.

GRUB STREET, a street in the parish of St. Giles, Cripplegate, London, now called Milton Street, and during the seventeenth and eighteenth centuries inhabited by translators, copyists and hack-writers. From this fact, the term *Grub Street* came to be used as descriptive of any inferior literary production; it was particularly popular at the time of Pope and Swift, but seems to have first been used against the writings of Fox, the martyrologist. Henry Fielding produced a *Grub Street Opera* in 1731, and about the same time the *Grub Street Journal* was published, Dr. Richard Russell and Dr. John Martyn being the principal contributors. It was against the writers of this street that Pope directed his *Dunciad*. Johnson and Goldsmith lived there.

GRUNDY, FELIX, an American statesman; born in Berkeley County, Virginia, Sept. 11, 1777. He was educated by Dr. Joseph Priestly at Bardstow Academy, studied law, and achieved a great reputation as a criminal lawyer. He was chosen a member of the Kentucky constitutional convention in 1779; was a member of the legislature from 1799 to 1806; in the latter year was appointed a judge of the supreme court of errors and appeals, and in 1807 became chief justice. This position he soon after resigned, removing to Nashville, Tennessee. He was a member of Congress from 1811 to 1814, United States Senator from 1829 to 1838, and Attorney-General in Van Buren's Cabinet. In 1840 he resigned his position in the Cabinet and was re-elected to the Senate. He died in Nashville, Tennessee, Dec. 19, 1840.

GRUNDY CENTER, a town and the capital of Grundy County, northeastern central Iowa, situated on the Burlington, Cedar Rapids and Northern railroad, 42 miles W.N.W. of Cedar Falls. It is a farming center. Thoroughbred

horses, cattle and hogs are raised. Population 1890, 1,161; 1900, 1,322.

GRUNER, WILHELM HEINRICH LUDWIG, a German writer on decorative art; born in Dresden, Feb. 24, 1881; studied engraving under Krüger; traveled and studied in France and Italy, and finally settled in England. He published *Decorations of the Garden Pavilion at Buckingham Palace* (1846); *Specimens of Ornamental Art* (1850); and *Fresco Decorations and Stuccoes in Italy* (1854). He died Feb. 27, 1882.

GRUNT. See GROWLER in these Supplements.

GRYSBOK (*Calotragus melanotis*), a small, active antelope of South Africa. It is one of the African steinboks. The animal is reddish brown in color. It is hunted for its delicious flesh.

GUADALAVIAR, a river of Valencia, Spain. See VALENCIA, Vol. XXIV, p. 33.

GUADALQUIVIR, a river of Spain. See SPAIN, Vol. XXII, p. 295.

GUADALUPE, a river of southern Texas, rising in Edwards County, and flowing E.S.E. into the San Antonio River, about 10 miles above its mouth, in San Antonio Bay. Its length is about 200 miles.

GUADALUPE HIDALGO, a town of Mexico, 2½ miles N. of the capital, on the Mexican and the Hidalgo and Northeastern railroads. It is noted for its shrine of Our Lady of Guadalupe, the special patroness of the Indians. The spot is visited by thousands of pilgrims annually. Guadalupe is also noted for the treaty signed here on Feb. 2, 1848, between the United States and Mexico, by which were ceded to the former the present states of California, Arizona, Nevada and a part of Colorado, and the territories of Utah and New Mexico. Population, 4,000.

GUADALUPE MOUNTAINS, a spur of the Rocky Mountains, in western Texas and southern New Mexico, between the Rio Grande and the Pecos. Altitude, 9,800 feet.

GUADIANA, an important river of Spain and Portugal, rising in lat. 40° N., in the province of Cuenca, central Spain, and flowing westward to Portugal, where it turns south and becomes the boundary of the countries for 40 miles, then it flows into Portugal, keeping a generally southward course, and emptying into the Atlantic Ocean, after again separating the countries of Spain and Portugal for about 30 miles. It is not of much service for commerce, as only about 10 miles are navigable. Its mouth is divided into channels, one of which is but 15 feet deep at the ebb-tide. Its length is 515 miles. Chief affluents, the Giguela and Guadaranque, and the Javalon, Zuzar and Ardila.

GUAIRA OR GUAYRA FALLS, of the Parana; the greatest cataract of Brazil. The river, from a width of 2½ miles, is contracted to 65 yards, the water plunging down an incline of 50° with a roar heard for many miles. See BRAZIL, Vol. IV, p. 222.

GUAM, GUAHAN, OR GUAJAN, the largest and most southerly island of the southern group of the Ladrões or Mariana Islands, in the North Pacific

Ocean, situated in  $13^{\circ}$  N. lat. and  $144^{\circ}$  E. long. It was settled by the Spaniards in 1667 (the chain having been discovered by Magellan in 1521). Spanish rule well-nigh depopulated the islands of their native race, the total population of the chain in 1667 (50,000 to 60,000) being reduced in 75 years to 1,816. The population of the islands in 1899 is estimated at 26,000, composed of aboriginal Chamorros, Tagal settlers from the Philippines, and Spanish half-breeds, Guam having about 10,000 of this number. Guam is of volcanic origin, and its soil, aided by the climate, is very fertile, producing areca and coconut palms, rice, maize, sugar, cotton, tobacco, indigo, breadfruit, bananas, and castor-oil. Forest growths are abundant, and the island is well watered. Agriculture is neglected, owing to the laziness of the inhabitants. Cattle, swine, and deer run wild in the island, and turtles and fish are plentiful. The climate is humid, but salubrious, and the heat is tempered by the trade winds, the yearly mean being  $81^{\circ}$  F. August and September are the warmest months, but the variations of temperature are not great. The year is divided into the wet and the dry seasons. The aboriginal language is a Micronesian dialect akin to that of the Philippine Tagals, but the prevailing tongue is Spanish. The principal town is San Ignacio de Agaña, having a population of about 5,000. Other villages are Somayi, or Suma, and Piti. In 1898, during the war with Spain, the United States cruiser *Charleston* paused in her voyage to Manila, to take possession of Guam. The incident stands out as pure comedy from the tragic background of war's stern realities. On the morning of June 20, with the three transports of the first Philippine military expedition, the *Charleston* entered Umata harbor and reconnoitred the ancient stone forts that defend the town of San Luis de Apra. No signs of life being discernible, several shells were discharged at the stone walls without inflicting any damage save scars and waking up some of the inhabitants of the town. A small boat appeared, whose occupants—the Spanish captain of the port, the surgeon of the garrison, and an English-speaking merchant who had formerly lived in the United States—boarded the cruiser and apologized most courteously for not returning the American salute. Their excuse—that there were no cannon or powder in the town, and that they were not in the habit of receiving salutes—was accepted by Captain Glass, who, however, undecieved them by stating that the morning's cannonade had been a bombardment, not a salute; that they were prisoners of war; and that he took possession of the island in the name of the United States. The Spaniards were ignorant of the fact that war existed between the nations, and of course were also ignorant of the destruction of the Spanish fleet at Manila. The governor of the island, General Marina, was notified of his enforced retirement, and he, his officers, and 54 Spanish soldiers were disarmed and taken as prisoners to Cavité.

Guam, being 900 miles from Manila, and 2,000 miles from Honolulu, is a direct link in the chain between the United States and its newly acquired territory in the Philippine Islands. On the conclu-

sion of the treaty of peace with Spain, the island was ceded to the United States. Captain Richard P. Leary, of the United States navy, was appointed the first governor.

GUANABACOA, a town of western Cuba, and a suburb of Havana, three miles to the east, with which it has railroad connections. It is a summer resort and residence town, being nicely located on a group of hills overlooking the harbor. It is well built, has fine gardens and groves, and is cooled by sea-breezes. Its hot springs and baths are well known, and are much visited by invalids. Population 1887: of town, 11,144; of commune, 28,043.

GUANAJUATO, an interior state of Mexico, on the Mexican central plateau and its southwestern slope. The Sierra de Gorda traverses the northern part of the state, and in the center the lofty Sierra de Guanajuato rises to the height of 11,030 feet above the level of the sea. It is drained by the river Lerma and its tributaries, and the land is fertile, notably the portion lying within the plain of Bajío. In the highlands, corn, wheat, and other grains are the principal products, and in the warmer valleys sugar-cane is raised. Chili peppers form an important item in the export trade of the state. Stock-raising is an industry of no little importance, though agriculture is somewhat neglected. Cotton and woolen goods are manufactured in various places, but mining is by far the most important industry. Silver is the first mineral product in point of quantity, but gold is abundant, and copper, lead, and quicksilver are found. The average yearly coinage of silver of the Guanajuato mint is \$4,500,000. The area of the state is 11,370 square miles, and its population in 1895 was 1,062,554.

GUANAJUATO, the principal city and the capital of Guanajuato, Mexico, located about the center of the state, is curiously situated on both sides of a deep ravine, traversed by the Guanajuato river, a small tributary of the Lerma. The streets are steep and tortuous, and the houses frequently rise to a height of five stories. It is at an altitude of 6,660 feet, and nearby is the celebrated Veta Madre (Mother Vein), long reputed to be the richest silver vein in the world. There are about fifty crushing-mills and amalgamation works, manufactures of various textile fabrics, a large mint, cathedral, barracks, colleges, convents, a government palace, and an art school. The Mexican Central line runs a branch to the city, and the electric light and the telephone have been introduced. Population 1895, 59,494.

GUANCHES, aborigines. See CANARY ISLANDS, Vol. IV, p. 796.

GUANINE, a basic substance related to uric acid, having the formula  $C^4H^6N^2O$ . It is secreted by the pancreas of some animals, and is found in considerable quantity in guano.

GUANTANAMO BAY, a bay on the southern coast of Cuba, situated about 40 miles east of Santiago, and one of the few harbors along the desolate coast that stretches westward from Cape Maisi to Cape Cruz. From this bay, during the Spanish-American War, a telegraph cable ran to Mole St. Nicholas, Haiti; and a similar connection existed with Santiago.

As this line established communication between Santiago and the outside world, it was necessary that the cables should be cut. Accordingly, on the 6th of June, 1898, after the close of the morning's bombardment of the Santiago fortifications, the *St. Louis* and the *Adria* (the latter a vessel especially equipped for the work) grappled for the line off Santiago harbor. This was unsuccessful, as, though they succeeded in cutting a cable, it was not the one to Guantanamo. Later the *St. Louis* moved down to Guantanamo Bay, grappled the Haitian cable, and cut it. The fort at Caimanera and a Spanish gunboat exchanged some shots with the protecting ships *Marblehead* and *Yankee*.

On the 10th of June the transport *Panther* and the *Yosemite* entered the bay with 600 marines under Lieut.-Col. Robert W. Huntington. Preceded by a party of 40 marines from the *Oregon*, and the Spanish fortifications having been silenced by the fire of the gunboats and cruisers, the marines effected a landing, occupying a hastily abandoned Spanish camp on the crest of the ridge. This was the first landing in force by American troops on the shores of Cuba, and the Stars and Stripes were hoisted over the camp amid great enthusiasm. The 10th and the best part of the 11th were occupied in completing the camp (which was named Camp McCalla, after the commander of the *Marblehead*) and landing stores; but on the latter date, while many of the men were bathing in the afternoon, the Spaniards concealed in the forest opened fire. The Americans hastily took up the defensive, and the skirmishing with the unseen foe continued through the night, the Spaniards following bush-fighting tactics, learned in their long struggle with the Cubans, with which their antagonists were unfamiliar. On the 12th the warships opened on the woods with shell, and did great service; but the fighting continued irregularly till the 14th, when a determined and concerted movement drove the Spaniards off, their water-supply being cut off and their heliograph apparatus captured. Cuban soldiers from General Garcia's command greatly assisted in the repulse of the Spaniards, following the same tactics of woodcraft which the enemy had so successfully adopted.

When repulsed on the 14th the Spaniards retreated to the town of Caimanera, on the west side and at the upper end of the bay. On the 15th and 17th the warships *Texas*, *Marblehead*, *Swanee*, and *St. Paul* effectually shelled Caimanera and drove the enemy out.

GUAPAY OR GUAPEY, a river of Bolivia, a tributary or rather the head waters of the river Mamoré. Its waters unite with the Rio Grande, and, flowing north, become the Mamoré, which flows into the Madeira river, q. v., in these Supplements. See also BOLIVIA, Vol. IV, p. 11.

GUAPORE OR ITENEZ, a navigable river of South America, rising in Brazil, and for some distance forming the boundary between Bolivia and Brazil. It unites with the Mamoré to form the Madeira.

GUARANINE, a nervous stimulant similar to if not identical with Caffeine. See COFFEE, Vol. VI.

GUARANIS OR GUARAYOS, South American Indians. See AMERICA, Vol. I, p. 702; and INDIANS, Vol. XII, p. 829.

GUARANTY. See GUARANTEE, Vol. XI, p. 236.

GUARANTY COMPANIES. See CONVEYANCING, in these Supplements.

GUARDAFUI, CAPE, the most eastern point of the African continent, and the extremity of an immense promontory (the Somali country), stretching seaward in an east-northeast direction, and washed on the northwest by the Gulf of Aden, and on the southeast by the Indian Ocean. The cape is in lat.  $11^{\circ} 50'$  N., and long.  $51^{\circ} 14'$  E.

GUARDIAN, one empowered to exercise care over the person or property of a person unable to care for himself by reason of immature age or other disability. The natural guardian of a child is his father, and upon the father's death, the mother. In the case of young children, or any one under full legal age, who have property interests, it is frequently necessary to have a guardian appointed to care for them or their property. Under such circumstances, children of sufficiently mature age to exercise judgment may generally select their guardian; otherwise a guardian is usually selected by a court of competent jurisdiction, under provisions in the state statutes investing the court with such power. The rules under which guardians shall act in caring for their wards and their property are usually established by statute in the various states. The relation of a guardian to his ward is that of a trustee, and the greatest care must be used in the exercise of his duties. The guardian will not be permitted to reap any benefit at the ward's expense.

GUARDS, THE, a name applied to the three regiments of cavalry and three regiments of infantry, constituting the British Household Brigade. The force consists of the First and Second regiments of Life Guards, and the Royal Horse Guards (cavalry), and the Grenadier, Coldstream, and Scots Fusilier Guards (infantry). See also ARMY, Vol. II, pp. 578, 580.

GUARNIERI OR GUARNERI, one of the three celebrated families of violin-makers of Cremona, Italy, who flourished in the seventeenth and eighteenth centuries. Prominent members were: ANDREA (1650-1695), a pupil of Niccolò Amati; his sons, GIUSEPPE (1690-1730) and PIETRO (1690-1725), and his nephew GIUSEPPE, commonly called Giuseppe del Gesù (1725-1745). The violins of this gifted family hold equal rank with those of the Stradivari.

GUASIMAS, LAS, a locality in Cuba (so named from the *guasima* tree, which grows plentifully there) about three miles from Siboney, between that place and Sevilla. During the Ten Years' War Gomez fought a battle here with the Spanish troops, which resulted in the slaughter of 600 of the latter with the terrible machete of the insurgents. In the Spanish-American War, on June 24, 1898, it was the scene of a conflict between Gen. Young's brigade of dismounted cavalry and a large force of Spaniards. The former consisted of two squadrons each (500 men) of the Rough Riders, the First United States Cavalry (245),

and the Tenth United States (colored) Cavalry (220),—a total of 965 men; the latter was composed of regular troops and guerrillas estimated at 2,800 men. The landing-place at Daiquiri being very much congested by the number of troops on the beach and adjacent hills, Gen. Young was directed, on the morning of the 23d of June, to move out on the left of Gen. Lawton's division, to encamp, and to cover the landing-places. In the afternoon he marched out, and on reaching Siboney (at which point Gen. Wheeler had been consulting with Gen. Castillo, the Cuban leader, and had himself made a personal reconnaissance) he learned that a large body of Spaniards was posted at an advantageous spot near Sevilla.

From Siboney there were two ways to reach this place, the summit of the pass overlooking Santiago: the one the regular road from Siboney to Santiago; the other a mere trail through the brush, which joined the main road just beyond the Spanish position, which thus commanded both ways, while it also afforded an opportunity for attack by two columns at once. This method was decided on, the Rough Riders being sent over the by-path, while the regular cavalry took the main road, with a battery of Hotchkiss guns. This division of the forces in the face of the enemy was a violation of tactical rules, but the situation was considered justification for the manœuvre. (The tactics pursued and the responsibility for the whole movement have met with much criticism, and it has been claimed that the command fell into ambush. This would seem to be disproved by official reports.) At 950 yards the Hotchkiss guns opened fire on the Spanish position, which was immediately returned by volleys from Mauser rifles. The Americans had to advance through dense undergrowth, clipping barbed-wire fences as they progressed. One man in five was armed with wire-nippers for this purpose, but the ingenious irregularity with which the wire barriers were set proved a most formidable obstacle to the advance of the troops, particularly in the face of a galling fire from an unseen foe.

Colonel Wood's Rough Riders, advancing on the left by way of the trail, turned the Spaniards' right flank as the regulars in the road turned their left, and the Spaniards began to retreat. A troop of the First Cavalry, moving on the ridge between the two columns, kept pace with both, ultimately deploying and forming a thin line of connection between them.

The Rough Riders' path brought them out at the end of a spur or ridge which was flanked and confronted by the Spanish line extended in a semilunar form on high hills. From these hills the Spaniards, familiar by long experience with the region and with methods of tropical bush warfare, poured a constant and deadly fire upon the advancing Americans; their smokeless powder betraying no sign of the location of their marksmen, and their bullets mowing down the advancing ranks with precision. The clouds of smoke from the American Springfield rifles revealed plainly the positions of the troops and made them an easy target. Reaching

an open space before the blockhouse on the heights, the Rough Riders, with an Indian yell, charged up the hill in the face of a terrific fire, Lieut.-Col. Roosevelt leading the men in person. At a critical moment, when the possibility of further advance seemed in doubt, the First and Tenth Cavalry burst up the hill, and, joining forces, drove the Spaniards in full flight toward Santiago.

The loss on the American side was 16 killed and 49 wounded. While this number was small in proportion to the results achieved, the prominence of some of the victims brought the reality of war vividly home to the American people. The skirmish also developed the reliability of the American soldier in the face of danger, the methods of Spanish warfare, the superiority of smokeless powder, and the Spanish inability to withstand close-quarters fighting; it also gave to the victorious side a strong foothold in the district that, three weeks later, was to be surrendered to their arms. The Spanish loss was uncertain; Gen. Wheeler reported that 39 dead Spaniards were found on the field, and that six wagon-loads of wounded were carried into Santiago.

Although Cuban support had been promised in this movement, no assistance was received or offered until after the position had been captured.

GUATEMALA, a republic of Central America, about 63,400 square miles in extent, with a population in 1895 of 1,800,000, about 60 per cent of whom are pure Indians, the remainder being mostly half-breeds. For general description, see Vol. VIII, pp. 238-242. The executive is vested in a president, elected once in six years. The legislative body is called the National Assembly, and consists of representatives chosen by universal suffrage for four years. The standing army numbers 3,700, the militia 67,300. The revenue of the country comes mostly from customs and taxes on spirits, tobacco, etc. About one tenth of this goes to maintain the army. The finances of the country are in a precarious condition. In 1894 the expenditures were greater than the revenue by almost \$2,000,000. In the same year the government defaulted on its bonds. The holders, mostly English, protested, threatening armed interference by the British government; but a compromise was agreed upon finally. The national indebtedness in 1895 amounted to \$12,000,000. Education in Guatemala is free and compulsory. There were 1,304 primary schools in 1894, kept up at a cost of \$1,120,000. There were about 150 miles of railroads, and 200 miles more were being constructed.

The republic was established March 21, 1847, and after forming for 26 years a part of the Confederation of Central America, began to govern itself independently in 1879. In 1895, war with Mexico on account of a boundary dispute was imminent. Both sides sent armies into the disputed territory, but the United States intervened and brought about a settlement by arbitration. The territory in question was ceded to Guatemala.

GUATIMOZIN, the last Aztec emperor; born in the city of Mexico, about 1495. He was the nephew and son-in-law of Montezuma II, and

succeeded to the throne after the death of Montezuma's brother in September, 1520. The Spaniards under Cortes laid siege to the City of Mexico, April 28, 1521, and Guatimozin offered a heroic resistance until August, when a surrender was necessitated by famine and pestilence among the Mexicans. The emperor tried to escape in a boat, but was captured on Lake Tezcuco by the Spaniards. He was well treated at first, but was murdered judicially by Cortes in 1525, upon the false accusation of having plotted against the Spanish captain's life. See CORTES, Vol. VI, pp. 441, 442.

GUAVARI OR GUAYABERO, a river of southern Colombia, South America, rising in the Cordillera Oriental, near lat. 3° N., and flowing east for 750 miles to the Orinoco, which it joins near San Fernando de Otabapo. It is navigable for nearly five hundred miles, but as yet has very little travel. Its upper course is comparatively unknown, except that it runs through dense, unfrequented forests.

GUAYAQUIL, a city of southwestern Ecuador, the principal seaport and seat of trade in the country, and the most populous city. It lies 165 miles S.S.W. of Quito, in lat. 2° 12' S., long. 79° 52' W., on the Rio Guayas, at the head of navigation for large boats. The city is well laid out, but is generally built of wood, on low ground, with a poor water-supply, and is very unhealthy. Severe epidemics of yellow fever, and a bilious fever called Guayaquil fever, are common. It is also liable to earthquakes. Work on the drainage system and improvements on the water system have been carried on for several years, but their progress is slow. A railroad line has been started from Duran (on the river, directly opposite) to Quito, and a part of it is now completed. A national university and a theological seminary are located here. The exports of Guayaquil are essentially the same as those of the country; for which, see ECUADOR, Vol. VII, p. 648. Guayaquil is the capital of the province of Guayas. In October, 1896, the city was partially destroyed by a terrible incendiary fire. Fifteen blocks, including the most important buildings, were destroyed. The loss approximated \$30,000,000. Population 1890, 44,772.

GUAYAQUIL, GULF OF, an inlet of the Pacific into the coast of Ecuador, between lat. 2° and 4° S. and long. 80° and 81° W. At its mouth it is 140 miles wide, and it narrows down as it extends inland, toward the east and north. It is divided by the island of Puná, east of which is the best anchorage. The gulf contains many islands and sand-banks, especially along the northwestern coast, which is avoided by sailors. The islands are all low, and mangrove-covered, except Puná.

GUBERNATIS, ANGELO DE, an Italian author and Orientalist; born in Turin, April 7, 1840. He was educated at the universities of Turin and Berlin; became extraordinary professor of Sanskrit in Florence (1863), and ordinary professor (1869). He began his literary career by publishing the tragedy *Pere Delle Vigne*, and subsequently

wrote other dramas. He is the founder of five Italian reviews, and is the Italian correspondent of the *Contemporary Review* of London and the *International Review* of New York. He is the author of *Zoölogical Mythologic* (1872); *Mythology of Plants* (1878); *Alexander Manzoni: A Biographical Study* (1879); and has edited *An International Dictionary of the Writers of the Day* (1888-91).

GUDE, HANS FREDERIK, a Norwegian landscape-painter; born at Christiania, March 13, 1825. He studied at the Academy in Berlin; in 1854 became professor at the Academy of Fine Arts at Düsseldorf; ten years later went to Carlsruhe; in 1880 was made director of the School of Painting in the Berlin Academy. He belongs to the Norwegian school of art, both by his manner and by his choice of subjects. The wild scenery of his native land and the rude life of its people engage his brush continually. Among his pictures are *The Bay of Christiania*; *High Mountains of Bergen*; and *A Scotch Landscape*.

GUEBERS OR GHEBERS, Parsees or Persian fire-worshippers. See PARSIS, Vol. XVIII, p. 325.

GUEBWILLER. See GEBWEILER, Vol. X, p. 126.

GUELPH, a post town of Ontario, Canada, capital of the county of Wellington, on the Grand Trunk and the Canadian Pacific railroads. The town has also manufactories of iron castings, machinery, sewing-machines, musical instruments, leather, agricultural implements, soap and candles, boots and shoes, and woodenware. The Ontario Agricultural College is near here. Population 1891, 10,537. See also GUELPH, Vol. XI, p. 245.

GUERBEL, COUNTESS LUCIA GENOVEVA TERESA, better known by her stage-name of GENEVIEVE

WARD, an American singer and actress; born in New York City, March 27, 1833. Her early years were passed in France and Italy, where Rossini superintended her musical education. She first appeared at La Scala, Milan, and at Bergamo, and sang in principal rôles of Italian opera at the Théâtre des Italiens, Paris. Having married



GENEVIEVE WARD.

Count Constantine Guerbel, a Russian officer, before going on the operatic stage, she sang under the name of Madame Guerrabella. She gave Italian operas in London, and in 1862 appeared in New York City and Philadelphia, and afterward in Havana. Losing her voice, she prepared herself for the dramatic stage. Being unfavorably received in New York, she went to England and played in Manchester, and later in Dublin, and at the Crystal Palace, London. She went to Paris in 1877 and played at the Comédie Française. In 1878 she appeared at Booth's Theater, New York, in *Jane Shore*, *Henry VIII*, and other plays. In

April, 1879, she leased the Lyceum Theater in London, and in the following year played at the Prince of Wales Theatre. In 1881-82 she toured the chief cities of the United States and Canada, and in 1882-83 in the Australian colonies. Returning to England in 1885, after a tour around the world, she managed the Lyceum Theatre in London till 1888, when she retired from the stage. Her earlier career was recounted in a *Memoir of Ginevra Guerrabella* and her later triumphs in *Genevieve Ward*.

GUEREZA, a monkey of the genus *Colobus*, found in tropical Africa. The fur, which is mostly black, is used for ornamenting clothing. Long white hairs hang down along the sides of the animal, and form a mantel-like covering. See APES, Vol. II, p. 151.

GUERICKE, HEINRICH ERNST FERDINAND, a German theologian belonging to the Old Lutheran school; born at Wettin, Prussia, Feb. 25, 1803. He became professor at Halle in 1829, and is the author of *Handbook of Church History* (1833), translated by Professor Shedd at Andover; *Universal Christian Symbolism* (1839); *Historical and Critical Introduction to the New Testament* (1843); *Manual of the Antiquities of the Church* (1847). He died in Halle, Feb. 4, 1878.

GUÉRIN, ALPHONSE, a French surgeon and medical writer; born at Vannes, in the department of Morbihan, Aug. 9, 1817. He studied medicine in Paris, and obtained his doctor's diploma in 1847; was in charge of the surgical department of hospital of Lourcine in 1855, Cochin in 1862, Saint Louis in 1863, and of L'Hôtel-Dieu in 1872. He was decorated with the star of the Legion of Honor, and in 1880 was made commander. He has published *Elements de Chirurgie Opératoire* (1858); *Maladies des Organes Genitaux Externes de la Femme* (1863); and *Du Pansement Ouaté* (1884). He died Feb. 21, 1895.

GUEROULT, ADOLPHE, French journalist and political economist; born at Radepont, Jan. 29, 1810. He was educated in Paris, and joined the St. Simonians in 1830. After the dispersion of the society by the government, he traveled in Spain and Italy as correspondent of the *Journal des Débats*. He was made consul at Mazatlan in 1842; later consul at Jassy; was removed by the provisional government, and became editor of the *République* and *Le Crédit Foncier*, later of the *Presse* and *Opinion Nationale*; was elected to the Corps Législatif in 1863. He published *The Colonial Question* (1842); *Studies in Politics and Religious Philosophy* (1862); *The Policy of Prussia* (1866). He died in Paris, July 22, 1872.

GUERRERO, VICENTE, a Mexican soldier; born in Tixtla, Mexico, Aug. 10, 1783; died at Chilapa, Feb. 14, 1831. He took part in an insurrection in 1809; subsequently gained several victories over the Spaniards, and in 1818 became a leader of the patriotic troops. In 1829 he was declared President of Mexico. He was deposed soon afterwards, and fled to the south, but was captured and shot at Chilapa, Feb. 14, 1831.

GUERRILLA, properly an irregular, petty

warfare on occasions of invasion or civil war, but now commonly applied to the individuals or bands carrying on such warfare. The word first came into popular use in Spain, where it was applied to the bands of peasants and shepherds who opposed Napoleon's armies in 1808-14, and they were active partisans of the Carlist cause in the civil wars of Spain. The name was brought to Spanish America, and thence introduced into the United States. In the late Civil War there were numerous guerrilla bands in the border states. When captured in war, they usually are allowed the privileges of war, unless found guilty of violating the laws of regular warfare. In the Franco-Prussian war, however, the German army executed many *francs-tireurs*, or guerrillas, as waging war without distinctive uniforms, and, at times, after the military occupation of a district by the invading army.

GUESS, GEORGE OR SEQUOYAH, a Cherokee half-breed, inventor of the Cherokee alphabet; born about 1770. He knew no language but his own, and was only known as an ingenious silversmith previous to his invention of the alphabet. This alphabet is considered to be the most perfect one ever devised, and consists of 85 characters, each representing a single sound. It has been employed in printing. Guess went with his tribe beyond the Mississippi, and emigrated with other Indians to Mexico in 1842. His Indian name is perpetuated in the *Sequoia*, or mammoth trees of California. He died in San Fernando, northern Mexico, in August, 1843.

GUEST, EDWIN, an English author and antiquary; born at Row Heath, Worcestershire, in 1800. He entered Caius College, Cambridge, in 1820; was graduated and made fellow in 1824; master in 1852; vice-chancellor of the university in 1854. The author of *History of English Rhythms* (1838, 2d ed., rev. by Prof. Skeat, 1882), and frequent papers on *Roman and Saxon England*, contributed to the *Archæological Journal* and the *Transactions* of the Archæological Institute, after his death collected in the second volume of *Origines Celtica* (1883). He died Nov. 26, 1880.

GUEST, JOHN, an American naval officer; born in Missouri in 1821. He entered the United States navy in 1837, as midshipman; served during the Mexican War, on the *Congress*, in the Pacific; made lieutenant in 1850; second in command on the *Plymouth*, stationed at Shanghai during the Chinese rebellion in 1854; made commander in 1862; commanded the *Owasco*, in Admiral Porter's mortar fleet, in the bombardment of Forts Jackson and St. Philip, and in the siege of Vicksburg; and the *Lehigh* and *Itasca* in the two engagements at Fort Fisher. In 1873 he was made commodore, and later commandant at the Portsmouth navy-yard, a position which he held until his death, at Portsmouth, New Hampshire, Jan. 12, 1879.

GUEUX OR "THE BEGGARS," the name assumed by the confederated nobles led by Count Brederode, who opposed the introduction of the Inquisition into the Low Countries by Philip

II of Spain. See HOLLAND, Vol. XII, pp. 74, 75.

GUIANA OR GUAYANA, a region of South America, lying between the Orinoco and Amazon rivers. The name is now usually confined to the European provinces, British Guiana, Cayenne or French Guiana, and Surinam or Dutch Guiana. Guiana was the "El Dorado" of Sir Walter Raleigh, and was formerly supposed to be rich in gold. Gold is found in the interior, in the Sierra Parime, but the true wealth of Guiana lies in its fertile soil and its boundless capabilities in tropical produce. Much of the interior is still unexplored. See GUIANA, Vol. XI, pp. 249-255.

GUIANA, BRITISH, has an area of 109,000 square miles, including about 48,000 claimed by Venezuela. The population numbers about 280,800, of whom 38 per cent are mainly East Indian coolies, 35 per cent African, 2 per cent Chinese, 1 per cent European, the remainder miscellaneous. The total exports amount to \$10,000,000 annually, of which sugar comprises 63 per cent; rum, 5 per cent; molasses, 1 per cent; gold, 25 per cent. The imports amounted to \$7,906,400 in 1895, of which 9 per cent was flour; rice, 8 per cent; pork, 3 per cent; butter, 1½ per cent; lumber, 2½ per cent; oils, 2 per cent; dried fish, 3½ per cent. There are 23 miles of railroad, 450 miles of river navigation, 360 miles of telegraph lines and a telephone line in George Town and New Amsterdam of 28 miles, with 450 subscribers. The currency is principally British gold and silver coins, with some local coins. There are 79,000 acres under cultivation in British Guiana. Gold-mining commenced in 1886; the output for 1886-94 was about \$9,000,000; for the year 1894-95, nearly \$2,000,000. As to the boundary dispute see VENEZUELA and MONROE DOCTRINE, in these Supplements.

GUIANA, DUTCH, OR SURINAM, a colony of the Netherlands; area, 46,060 square miles; population, 62,469. The capital and chief city is Paramaribo, with 30,000 inhabitants. The superior administration and executive authority is in the hands of a governor, assisted by a council composed of the governor as president, the attorney-general as vice-president, and three members, all nominated by the crown. The colonial states form the representative body of the colony. Four members are chosen every year by the governor; the others by electors, in proportion of one in two hundred electors. Entire liberty is granted to the members of all religious faiths. The local revenue is derived from import, export and excise duties, taxes on houses and estates, personal imposts, and some indirect taxes. A subvention from the mother-country is necessary. For 1895 the estimated revenue was 1,726,000 guilders, and the expenditures 2,089,000 guilders. The imports in 1893 amounted to 5,730,365 guilders; the exports, 5,467,631 guilders. In 1893, 8,739,000 kilogrammes of sugar was produced; cacao, 3,398,000 kilogrammes; bananas, 591,128 bundles; rum, 521,494 liters; molasses, 1,606,528 liters. The export in gold in the same year was 1,159,675 grammes, amounting to 1,588,755 guilders.

GUIANA, FRENCH, OR CAYENNE has an area of 46,697 square miles, and a population of 26,502. The capital and chief city is Cayenne, with a population of 10,000, of which 4,000 are ticket-of-leave or confined convicts. The exports amount annually to about \$850,000; the imports, \$1,800,000. The colony is used as a penal settlement; but the climate was found to be very unhealthful, and since 1864 no convicts have been sent there. It is under a governor appointed at Paris, and sends one deputy to France to represent it. Cayenne was used as a station by the Royal Astronomical Society, as a point of observation of the total solar eclipse, Dec. 21-22, 1889.

GUIANA BARK, FRENCH, the bark of *Portulandia hexanara*, also called *Conteria speciosa*, a tree of the Cinchona group of the family *Rubiaceæ*; with opposite ovate leaves and corymbs of very large purple flowers; a native of Guiana. The bark is esteemed a very powerful febrifuge.

GUIGNET'S GREEN, a pigment used in calico-printing. See BORAX, Vol. IV, p. 51.

GUIJA, LAKE. See GUATEMALA, Vol. XI, p. 239.

GUILD, REUBEN ALDRICH, an American author; born at West Dedham, Massachusetts, May 4, 1822. He was educated at Brown University, and graduated in 1847. Became librarian for the university in 1848, and held the position until 1893. He published *History of Brown University* (1867); *Chaplain Smith and the Baptists* (1885); *Footprints of Roger Williams* (1886). He has also edited several works by Roger Williams.

GUILDHALL, London. See LONDON, Vol. XIV, p. 820.

GUILFORD, a town of New Haven County, Connecticut, on Long Island Sound, and on the New York, New Haven and Hartford railroad, 14 miles E. of New Haven. Farming, iron-working and the manufacture of woolen goods are the chief industries. Guilford was settled in 1639 by English colonists, and it has some very old buildings. Population town and borough, 1900, 2,785.

GUILFORD COLLEGE, a co-educational school, founded in 1888, at Guilford College, North Carolina. The president of the institution is Lewis L. Hobbs; the number of students, 200; instructors, 10. It has a library of 2,500 books. The total income of the college amounts to \$13,000, and it is controlled by the Friends.

GUILFORD COURTHOUSE, BATTLE OF. See UNITED STATES, Vol. XXIII, p. 743.

GUILLAUME, JEAN BAPTISTE CLAUDE EUGÈNE, a French sculptor; born at Montbard, Burgundy, Feb. 3, 1822. Educated at the College of Dijon, and studied art at the School of Fine Arts in Paris; became professor at the school in 1863, and in 1864 director; was sent to Rome as head of the French Art School in 1891. Among his works are *The Tomb of the Gracchi*; a *Statue of Napoleon*; *Anacron's Guests*, a bas-relief; the *Monument of Colbert* at Rheims.

GUILMANT, FÉLIX ALEXANDRE, a noted French organist and composer; born at Boulogne, March 12, 1837. He began to study music at an



early age, under his father, who was organist of St. Joseph's, at Boulogne, and when 16 years old took his father's place. In 1871 he became organist of the Church of the Trinity, in Paris. In 1893 Guilment made a professional tour through the United States. He has composed *The Practical Organist* (47 pieces, for the organ); *O Salutaris*, for bass, baritone and organ; *Quam Dilecta*, a psalm; *Balthazar*, a lyric cantata; the *Crusaders at Jerusalem*, a piece for four voices.

GUINEA, FRENCH. See AFRICA, in these Supplements.

GUINEA-PIG. See CAVY, Vol. V, p. 277.

GUINEA-WORM. See NEMATOIDEA, Vol. XVII, p. 325.

GÜINES, a town of Cuba, 30 miles S.E. of Havana, with which it is connected by railroad. It is an important farming and grazing center, and it has a large trade. It was founded during the eighteenth century, but its population until after 1887 was less than 4,000. The building of the railroad gave its growth a great impetus, and in 1896 it had a population of over 13,000.

GUINICELLI, GUIDO, an Italian lyric poet; born in the thirteenth century, of a noble family of Bologna. Little is known of his life, the chief fact of interest being that he greatly modified the style of the Provençal troubadours, which up to this time was artificial and conventional. Becoming interested in the speculations of St. Thomas Aquinas and St. Bonaventura, he began to introduce them in his poetry, working out a new theory of love, and explaining it in philosophical terms. The new style powerfully attracted Dante, who adopted it, in part, in the *Vita Nuova* and the *Divina Commedia*. He died in 1276. See ITALY, Vol. XIII, p. 503.

GUINNESS, H. GRATTAN, an Irish home missionary; born near Dublin, Ireland, August, 1835; educated at New College, London; in 1856 ordained as evangelist; founded the East London Institute for Home and Foreign Missions, Harley House, London. He was the author of *The Approaching End of the Age* (1878); *Romanism and the Reformation* (1887); *Hymns of the Cross* (with Mrs. Guinness, 1864); *The Divine Programme of the World's History* (with Mrs. Guinness, 1888); and other works.—GUINNESS, MRS. FANNIE E., wife of H. Grattan Guinness, born April, 1831; married 1860; secretary of the first Christian Mission on the Congo and of the Livingstone Inland Mission. She has written, besides works in collaboration with her husband, *She Spoke of Him* (1872); *The Story of Our Sixth Year at the East London Institute* (1880); *Sitwani's Story* (1882); *The Wide World and Our Work* (1886). Mrs. Guinness was one of the first women preachers of the Gospel.

GUIRAUD, ERNEST, a French-American composer; born at New Orleans, Louisiana, June 23, 1830. Studied music under his father, and at 15 composed his first opera, *Le Roi David*; attended the Conservatoire in Paris, supporting himself by playing the kettle-drum in an orchestra; served in the Franco-Prussian war in 1870-71; in 1876 was chosen to a professorship in the Con-

servatoire. He composed *Sylvie*, a one-act opera brought out in Paris in 1864; *En Prison* (1869); *Le Kobold* (1870); *Gretna Green*, a ballet (1873); and two *Suites for Orchestra*. He died in Paris, May 7, 1892.

GUISCARD, ROBERT. See ROBERT GUISCARD, Vol. XX, pp. 596, 597.

GUITEAU, CHARLES JULES, assassin of President Garfield; born in Freeport, Illinois, Sept. 8, 1841; admitted to the bar, but achieved no success; published some pamphlets, setting forth his views on various moral questions, which were of the most erratic character; married, but his wife obtained a divorce from him, and he obtained a precarious living by lecturing and writing. He had been a member of the Oneida Community, but was expelled from that body. Guiteau became an office-seeker, and persistently solicited an appointment as consul from President Garfield. Enraged at being refused, he lay in wait for the President, and shot him, July 2, 1881. He was tried in Washington, District of Columbia, found guilty of murder, and executed, June 30, 1882.

GUITONE, D'AREZZO, an Italian poet; born at Santa Firmina, Italy, in the first part of the thirteenth century. In early life he wrote chivalrous love-songs in imitation of the troubadours, but later joined the order called *Frati Gaudenti*, condemned all that he had hitherto praised, and began writing poems and letters, in the Latin style, on political and religious subjects. He left 35 sonnets, which were published in Florence in 1838, under the title of *Revire*. He died in 1294. See ITALY, Vol. XIII, pp. 501, 502.

GULF STREAM. See ATLANTIC OCEAN, Vol. III, pp. 18-20.

GULFWEEED, a common name for *Sargassum*, a genus of seaweeds of the family *Fucaceae*, of which immense quantities are found in all oceans, floating in huge, detached masses. The frond is long, sometimes hundreds of feet, and is furnished with distinct stalked, nerved leaves and simple axillary stalked air-bladders.

GULL, SIR WILLIAM WITHEY, an English physician; born Dec. 31, 1816, at Thorpe-le-Soken, Essex, England; graduated M.D. in 1846, at the London University; professor of physiology at the Royal Institution of Great Britain from 1847 to 1849; elected fellow of the Royal College of Physicians in 1848; for twenty years physician and lecturer at Guy's Hospital, retiring about 1867. In 1871 he was created a baronet for services rendered during the illness of the Prince of Wales, and appointed one of her Majesty's physicians extraordinary. He was the author of *Reports on Epidemic Cholera* (with Dr. W. Baly, 1854); *Gulstonian Lectures on Paralysis; Alcohol as a Medicine and as a Beverage* (1878). He died in London, Jan. 29, 1890, leaving the largest fortune ever amassed by a practicing physician.

GULLIVER, JOHN PUTNAM, an American divine and educator; born in Boston, Massachusetts, May 12, 1819. He graduated at Yale College (1840); at Andover (1845); pastor in Norwich, Connecticut (1846-65); in Chicago (1865-68)

president Knox College, Galesburg, Illinois (1868-72); pastor at Binghamton, New York (1872-78); professor at Andover Seminary (1878-94; emeritus after 1891). He was a member of the Yale College Corporation, and was influential in the establishment of the Free Academy at Norwich, Connecticut. He died at Andover, Massachusetts, Jan. 25, 1894.

**GUM BENJAMIN.** See **BENZOIN GUM**, Vol. III, p. 581.

**GUM DRAGON OR DRAGON'S BLOOD.** See **INCENSE**, Vol. XII, p. 718; and **GUM**, Vol. XI, p. 275.

**GUM LAC.** See **LAC**, Vol. XIV, p. 181.

**GUMMING**, a disease which attacks the plum, cherry, peach and other stone-fruit trees, whose presence is known by the amber-colored gum which exudes from wounds in various parts. It is claimed that the cause of the disease is a fungus named *Coryneum Beijerinckii*. The mycellum of the fungus develops a ferment which transforms the cell-walls, starch-granules and other contents of the cells into gum. The fungus cannot penetrate sound, healthy bark; there must be some wound or abrasion before it can enter the cellular tissues in which it can spread. Probably, insects are the chief agents in carrying the contagion from tree to tree. Wounds, as soon as they are observed, should be coated with a thick paste of quicklime or coal-tar. Gummed branches should be cut away without delay and burned, and the wounds dressed at once with coal-tar.

**GUM-PLANT**, a common name given to the species of *Grindelia*, a genus of the family *Compositae*, named in honor of Dr. Grindel, a German botanist. It inhabits the plains region of the American continent from the Mississippi River to the Pacific coast. The leaves are usually rigid, and often covered by a viscid exudation, or gum. In medicine it has gained popularity in the West as a remedy for poisoning by species of *Rhus*, and in asthma and bronchitis.

**GUM RESINS.** See **GUM**, Vol. XI, p. 276.

**GUMTI**, a river of the Northwest Provinces, British India, rising near long. 80° E. and flowing E. S. E., past Lucknow, into the Ganges. Length, 360 miles. It is navigable for small boats as far as Lucknow. Altitude of source, 520 feet.

**GUM TREE**, a name applied in the United States to various important trees. The sour-gum, black-gum, pepperidge, or tupelo (*Nyssa multiflora*), is a large tree, producing a firm timber, which is used for hat-blocks, windmill-shafts, hubs, etc. The *N. capitata* bears a sour, edible fruit. The *N. uniflora* and *aquatica* have soft, light wood, and their roots are used somewhat as substitutes for cork. The *Liquidambar Styraciflua*, the sweet-gum, is a large tree with star-like leaves. The firm and fine-grained wood is used in furniture-making. It yields a balsamic resin called American storax. *L. orientale* and *L. altingia* also yield storax, and the latter has a hard, heavy, fragrant red timber. The gum-trees of Australia are species of *Eucalyptus*, immense trees, and becoming extensively planted in swampy grounds

of the warmer parts of the United States and Europe. They grow very rapidly, and are prized for draining boggy places, in that capacity being known as fever-and-ague trees.

**GUN-CONSTRUCTION.** See **GUNMAKING**, in these Supplements.

**\*GUNMAKING.** A full account of gunmaking in Europe from its earliest inception, including a description of the characteristic American guns that have been adopted by European nations, will be found under **GUNMAKING** and **GUNNERY**, Vol. XI, pp. 278 et seq.

**IMPROVEMENTS IN MACHINE-GUNS.** The principal modifications, of late years, have been in the direction of automatic working, the force of recoil or escaping gas being utilized to perform the operations of loading and firing. These systems involve either a forward motion of the barrel or a withdrawal of the supporting breech, thus introducing more or less weakness and complexity of system. The Gatling gun still remains the standard for machine-guns in our military service, and in this the only important modifications relate to the "feed," or method of supplying ammunition. The old prominent and clumsy drums have been replaced by a short and simple vertical plate with two grooves for guides, and into these the flanged heads of the cartridges are rapidly introduced directly from the pasteboard packing-boxes. A shield is proposed for the complete protection of the detachment in the field against the fire of small projectiles.

**RAPID-FIRING GUNS.** Modern conditions of offense and defense have rendered necessary this new class of guns, designed for the following uses: 1. In the land-service, against torpedo-launches, for the protection of mine-fields or systems of torpedoes, to impede and if possible prevent, the removal or disabling of the defensive mines. 2. In the naval service, against rapidly moving and lightly protected torpedo-boats maneuvering to attack. 3. In both services, against the secondary lightly protected batteries of modern battle-ships.

To facilitate rapid firing, these guns are mounted so as to secure the least practicable recoil, and, as a rule, are loaded by hand, with fixed metallic ammunition similar to that employed for small arms, and are provided with shoulder-rests to insure rapid and easy pointing. Triggers are provided for firing, either electrically or by percussion. If recoil is permitted to any degree, as in the larger calibers, provision is made for automatically running the guns into position after firing. Besides the saving of time and labor in loading, the metallic cases serve to protect the charge from climatic deterioration.

The requisites of the breech-mechanism are: 1. Simplicity and rapidity of action; 2. Security in locking, and safety from premature explosion of charge before the block is closed.

The limit in caliber is determined by the difficulty in keeping the recoil within the required bounds, the obstacles experienced in making metallic cases of the required size, and the fact

that the weight of each round must be such as to permit rapid and easy handling.

The caliber of six inches is at present about the maximum limit, and rapid-firing guns up to that size will doubtless soon constitute wholly the main batteries of unarmored vessels and the auxiliary batteries in battle-ships.

To obtain highest possible muzzle-velocities, the rapid-firing guns are distinguished by comparative great length of bore, extending, in extreme cases, to fifty calibers.

To insure continued and accurate fire with these guns, smokeless powder is deemed a necessity, and with this, remarkable velocities have been obtained, accompanied with permissible pressures.

**IMPROVEMENTS IN REVOLVERS AND PISTOLS.** One defect of the ordinary revolver has been the considerable and variable escape of gas between the cylinder and rear of barrel. This, in recent inventions abroad, has been overcome by allowing the cartridge to project beyond the front face of the cylinder. For firing, the cylinder is thrown forward so that the cartridge-case is entered in the barrel sufficiently to act as a gas-check.

Another recent invention in this class of small arms is the automatic or semi-automatic repeating magazine-pistol, the general principles of which are exemplified in the Mannlicher (model 1894). In this, the reaction due to recoil (together with the *drag* of the projectile) causes the barrel to slide relatively forward against the force of a spiral spring, the latter then returning the barrel to its place, the operations for reloading being carried out during the two movements. The cartridges are contained, one above the other, in the magazine in the upper part of the handle. These are raised by a spring, one by one, into the receiver, and held for loading in prolongation of the barrel when in its forward position. The barrel remains in the forward position during the short interval that the pressure is maintained on the trigger. As the latter is loosed, the barrel is released and returns to its firing-position, receiving into its chamber a fresh cartridge.

The lock-action differs in no way from that of the ordinary double-action revolver, the alternative being offered either of both cocking the hammer and releasing it by one long pull on the trigger, or of cocking by hand, when a light pull suffices for firing. The magazine can be replenished singly or from a "clip" containing five. A projection on the barrel serves to push the barrel forward by hand to introduce the first cartridge of a series.

It will be understood that these proposed changes introduce added complexity into weapons already sufficiently intricate, and it may well be remarked here that simplicity is the secret of success in all arms and material for the military service. A complicated mechanism may be made to work beautifully at times, but, more or less frequently, functions very poorly, or not at all, when the need for it is most pressing.

**IMPROVEMENTS IN MILITARY RIFLES.** During the last fifteen years radical changes have taken

place in the standard military rifle. These involve *increased rapidity of fire, marked reduction in caliber, and the use of a new propelling agent—smokeless powder.*

As to the first, the new models are classed either as *magazine* or *repeating* arms. With the former, the ordinary use of the rifle is as a *single loader*, with a reserve-supply of ammunition in the magazine for extremely rapid fire at the critical periods of a battle, or to take advantage of passing opportunities suddenly presented when the greatest possible volume of fire is desired. The number in reserve varies from five to twelve. A simple movement serves to throw on the magazine. The *repeaters* have a receptacle for a number of cartridges; but these are expended from shot to shot, and when emptied, the reservoir is quickly refilled by the use of packages contrived for convenient carrying and rapid loading. There is, in this system, therefore, no retention of a reserve for use in the crises of battle, but it permits a general increase in the rapidity of fire. By the addition of a "cut-off" the repeater becomes a magazine arm.

The comparative merits of the two systems involve questions of the weight of ammunition to be carried by the soldier, the possibility of replenishing the supply during the heat of an engagement, the condition of the troops as to fire-discipline, and the influence on the morale of always having in one system a reserve. Troops under rigid fire-discipline are expected to remain cool, husband their ammunition, and, up to a certain period at least, remain, as to firing, under the complete control of the officers. If such discipline does not exist, it is believed that less demoralization will result, with less consequent waste of ammunition, if the loading is more deliberate—shot by shot—and the morale is strengthened by the consciousness of reserve-power. Occasion having arisen for the use of the magazine, it is presumed that in the ebb and flow of battle there will not be wanting opportunities for recharging it, this being easily and quickly accomplished.

Fire-discipline is also required here, that the magazine may be reserved for those occasions when a decisive blow is to be struck or an imminent peril to be warded off.

As regards the character and position of the cartridge-reservoir, it may be,—1. A tubular magazine along the barrel, usually beneath; 2. A tubular magazine in the stock; 3. A box, with cartridges side by side, in the vicinity of the receiver, and usually beneath. This may be either detachable or fixed.

In the first and second classes the cartridges are loaded singly, and, as a rule, against the power of a spiral spring, the process being comparatively slow and difficult. The limit of military cartridges impelled satisfactorily by the spring is seven or eight, and being in close contact—end to end—there is some danger of the explosion of sensitive primers due to the intense heating and concussion of rapid firing. These accidents are

believed to be rare, but have sufficed to shake general confidence in the system. Then, again, the position of the center of gravity is changed at each shot, when the magazine is on, and this affects the *balance* of the gun and the accuracy in rapid shooting.

Weight of opinion is at present overwhelmingly in favor of the third system, the cartridges being, in general location, not far from the center of gravity. The receptacles are, as a rule, extremely simple and easily replenished.

As regards the breech-mechanism, the *bolt* system seems to be the only one to which the magazine can be successfully adapted in military arms. The sliding and hinged block systems, though superior in strength, have made way for the developed and modified bolt.

**CALIBER.** In the introduction of the small-caliber rifles, it is determined to sacrifice power at the longer ranges and stopping-effect for the advantage of flat trajectories, and greatly increased "dangerous space" at the shorter ranges, within which the greater portion of the ammunition is to

The reduction in caliber is limited by the following: 1. Mechanical difficulties in the manufacture of the barrel and in cleaning the grooves; 2. Increased difficulties to be overcome in the manufacture of suitable ammunition; 3. Decrease in stopping-power.

**AMMUNITION.** The great difficulties in the change to small caliber lie in the ammunition.

**PROJECTILE.** The diameter of the projectile being reduced and the length remaining practically unchanged, to insure stable and accurate flight increased velocity of rotation about the longer axis becomes necessary. Otherwise it is likely to "tumble" or rotate about the shorter axis at some point of its flight, and the accuracy be destroyed. With the increased twist to the rifling, it is found that the lead projectiles, even when hardened by admixture of tin or antimony, are liable to strip and *lead* the grooves. This is especially objectionable and troublesome in a small-caliber rifle. Hardened beyond a certain point, the bullet becomes brittle, and is liable to break up on striking. Then the cost is increased

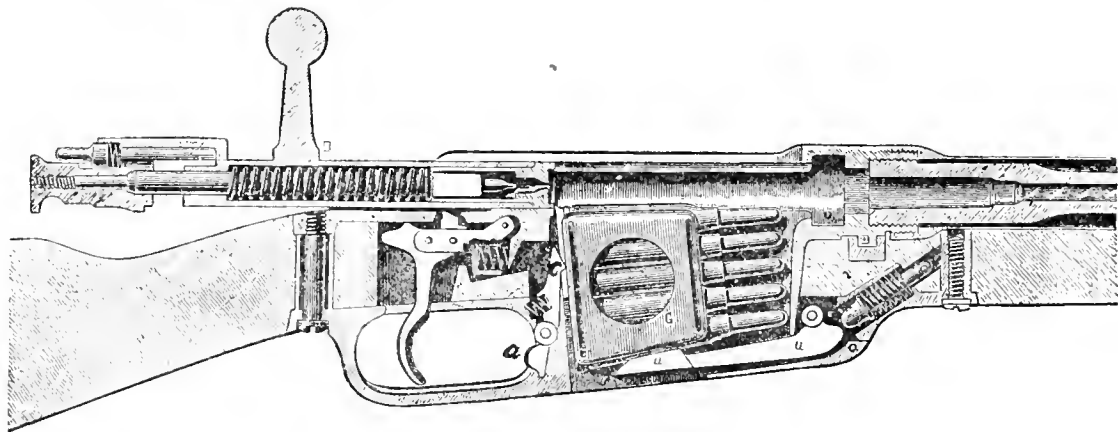

MANNLICHER MAGAZINE RIFLE—MODEL 1888.

be expended. As the trajectory more nearly approaches the right line, the less the bullet rises above the line of sight, and the more extended are the shot-swept spaces, or "dangerous zones," within which men standing or kneeling are likely to be struck. The small-caliber projectile, being in weight less than one half the old standard, leaves the muzzle with a velocity per second greater by 700 feet or more. The trajectories, in consequence, are extremely flat, and the penetrations very great.

The admitted advantages of the smaller calibers are: 1. Ammunition of less weight, allowing an increase of one third or more in the number of rounds carried; 2. Increase in flatness of trajectory and extent of dangerous spaces; 3. Increased accuracy; 4. Greater penetration; 5. Diminished recoil.

There is a controversy as to whether or not the wounds are more humane. Experiments to determine this satisfactorily are accompanied with much difficulty, and diverse conclusions result from diverse conditions as to bullet, velocities, etc.

considerably, and it is desired, so far as possible, to retain the weight due to the great specific gravity of the lead. These difficulties have been overcome in a compound projectile, having a core of compressed and hardened lead, with a thin jacket of steel, copper, nickel, etc., or a combination of these metals. On firing, the jacket is pressed by the *lands* into the easily yielding core, and the projectile takes the shape of the bore without permitting escape of gas.

**CARTRIDGE-CASE.** It is necessary not to have the cartridge increased to any extent in length, as this would require an increased length and movement of the bolt, and introduce other troublesome complications; moreover, a long cartridge of small diameter is weak, and liable to injury. To avoid this, the case is bottle-shaped, with body considerably larger than that of the projectile, and tapering noticeably from shoulder to base. As the caliber is more and more reduced, the differences in diameter between case and projectile become more pronounced, and the circumstances of the explosion of charge tend to higher pressures, with greatly increased strain on

the breech. Brass is employed for case metal, being more elastic and easier of extraction than copper, and also cheaper.

To illustrate the general principles involved in the construction of modern rifles, the German Mauser-Mannlicher is represented on page 1483 in its most salient features. It is a typical repeater.



CARTRIDGE.

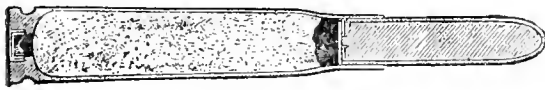

CARTRIDGE (SECTION).

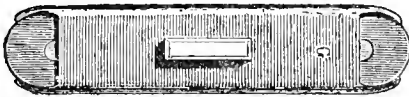

CASE (REAR VIEW).

The cartridges are issued in packages of five, contained in a simple loading-case, *G*, of tin or thin sheet-iron stiffened by ribs; the rear interior projecting rib of the case taking in the annular groove of the cartridge-head. The case is placed in the magazine through an opening in the receiver, and pushed down until a projection in its rear face engages the catch, *C*. The elevating spring, *u*, is simple in construction, and has attached to it a *carrier-plate* to support the cartridges. This carrier-plate, when the magazine is empty, closes the well in the receiver, and enables the use of the arm as a single-loader. It cannot be used as such, however, while any cartridges remain in the magazine. The top cartridge is always in position to be pushed into the chamber by the forward motion of the bolt. If desired at any time to insert a fresh case, the one in use having been partially emptied, a slight pressure on the catch-knob, *a*, releases the case from the catch, *c*, when the elevating spring ejects both case and cartridges. So long as any cartridges remain, the case is retained in position by the pressure from the spring acting through the uppermost cartridge on the curved upper edges of the case. As the last cartridge is pushed out by the bolt, the case drops through by its own weight.

The recoil is supported by two locking-lugs on opposite sides, and near the forward end of the bolt. These engage in two recesses just in rear of the chamber. The rest of the bolt thus becomes merely a means for operating the locking-device and carrying-extractor, mainspring and firing-pin.

The shell of this bolt, in consequence, is made lighter, and this permits the advantage of a larger and more powerful mainspring. On the introduction of smokeless powder, it was found that the

bolt had been reduced too much to withstand the higher pressure then developed, and modifications were found necessary.

**COCKING.** The body of the bolt carries an inclined plane, or *cam*, which abuts against a piece attached to the rear end of the firing-pin. When the bolt is rotated to open the gun, this cam sets back the firing-pin and retains the spring in compression until the bolt is returned to its place, when the act of locking releases the firing-pin, now held in place, however, by the sear. This arrangement relieves the soldier's hand from the jarring action caused by having to force the bolt home against a powerful spring with the palm of the hand or muscles about the base of the thumb, an action which in rapid and prolonged fire has been found to cause serious damage to the soldier's hand, from the mass of nerves which are involved, and which become bruised and injured.

The raising of the bolt-handle, after firing, forces back the bolt slightly, and loosens the shell, usually overcoming with ease any tendency to stick in the chamber.

The barrel in the model represented is enveloped nearly to the muzzle in a casing of thin steel, strong enough to withstand the rough usage of service, and carry the sights and bayonet. The air-space between is supposed, in rapid firing, to keep the casing from becoming so overheated as to burn the hand or melt off the sights. The muzzle passes freely through the casing, so as to permit free expansion and contraction of the barrel. This arrangement has not been found to work well, and the use of a wooden guard to protect the left hand in firing is preferred.

The United States magazine-rifle, caliber 30, is a representation of the *magazine* class. Fig. 2 shows a cross-section through *receiver* and *magazine*, the latter fully charged, but *cut off*, and the bolt closed. With the magazine not in use, the

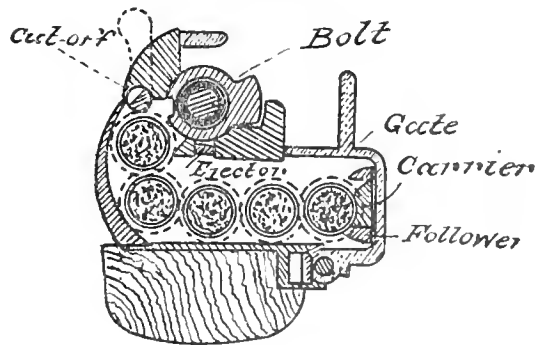

Fig. 2.

CROSS-SECTION KRAG-JØRGENSEN RIFLE.

cut-off spindle bears down upon the head of the upper cartridge, pressing it back into the magazine, and below the action of the bolt. The magazine mechanism, therefore, remains inert, and the arm operates as a single-loader. Turning down the cut-off thumb-piece rotates the spindle into its channel in the receiver, permitting the cartridges in the magazine to rise until the head of the upper one projects sufficiently into

the receiver to be struck by the head of the bolt in its forward movement.

The *carrier* is actuated by a spring, and through the *follower* pushes the cartridge to the left and up the slight incline into the magazine-channel. The magazine is refilled through the open gate, either by hand or from a charger.

The automatic rifles, working similarly to the revolver already described, are receiving some attention, but have not yet demonstrated that they possess the requisite qualities for military arms.

The following table contains data of interest regarding the arms of the principal civilized nations:

calibers is considered much in their favor, however, except for positions where guns of the highest possible power may be required. In the discussion of the principles of heavy gun construction, and the methods as followed in the United States, the able review\* of Captain Rogers Birnie, ordnance department, United States army, has been followed in so far as the limited space has permitted.

**GUN-CONSTRUCTION IN THE UNITED STATES.** In this country, as elsewhere, the muzzle-loading guns of iron and bronze, and the composite iron and steel guns of an intermediate period, have been supplanted by the built-up steel breech-loader.

SMALL-CALIBER RIFLES.

COUNTRY.	SYSTEM.	DATE.	CALIBER.	MAGAZINE.		WEIGHT WITHOUT BAYONET.	WEIGHT OF CARTRIDGE.	WEIGHT OF BULLET.	INITIAL VELOCITY.	REMARKS.
				Kind.	No. of Rounds.					
Austria	Mannlicher	1888	Inch. .315	Box	5	Pounds. 9.7	Grains. 454	Grains. 244	Ft. per second. 2,067	Stated that as result of exhaustive trials the .197 caliber has been selected. Believed that re-arming will not take place at present.
Belgium	Mauser	1889	.301	Box	5	8.6	441	219	1,968	
Denmark	Krag-Jørgensen	1889	.315	Side box	5	9.4	463	238	1,968	
England	Lee-Netford	1889	.303	Box	8 or 10	9.4	432	216	2,100	
France	Lebel	1886	.315	Tubular	8	9.2	386	208	2,073	
France (carbine)	Berthier	1890	.315	Box	3	6.6	386	208	2,000	.256 and .236 calibers are being tested, and still smaller calibers to be tried.
Germany	Mauser-Mannlicher	1888	.311	Box	5	8.4	420	224	2,034	
Holland	Mannlicher	1893	.256	Box	5	8.65	346	155	2,395	
Italy	Mann-Cannaro	1891	.256	Box	6	8.36	331	161	2,296	Re-arming goes on slowly.
Norway	Krag-Jørgensen	1893	.256	Side box	5	8.8	363	160	2,300	
Portugal	Kropatschek	1886	.315	Tubular	7	10.0	542	246	1,984	
Russia	Mouzin	1891	.300	Box	5	8.8	393	208	2,001	
Spain	Mauser	1893	.276	Box	5	8.7	373	173	2,286	
Sweden	Mauser	1893	.256	-----	-----	-----	-----	-----	-----	
Switzerland	Schmidt	1889	.296	Box	12	9.46	424	212	1,968	
Turkey	Mauser	1890	----	Box	5	8.9	417	213	2,139	
United States	Krag-Jørgensen	1892 1896	.300	Side box	5	9.35	435	220	2,000	

**HEAVY ORDNANCE.** Within the last twenty years, *steel* as a metal for heavy ordnance has greatly improved and gained the confidence of experts to the extent that all other metals now, as a rule, are excluded from constructions in which high power is a requisite. The principles of construction are better understood, and the processes greatly improved. Some failures of heavy calibers abroad, the expense attending manufacture, and other conditions in regard to providing for them on modern battle-ships, have tended to the limit of caliber, not exceeding thirteen inches for naval use. This limit has not, however, been accepted for the land-service, where the conditions as to weight and space are not so rigidly fixed.

The greater rapidity of fire of the smaller

The excellence of the system is due to increased knowledge of the characteristics and manipulation of *steel*, maintenance of a high and uniform standard in the metal by a rigid system of inspection and test, and to the careful application, in the built-up construction, of the principles of initial tension. Steel is employed wherever strength is important, and the building-up process nearly doubles the resistance over that offered by a simple tube of the same thickness. A "built-up" gun is defined as consisting of a series of concentric simple cylinders or layers, in which the principle of initial tension is secured by the method of assembling.

A gun, considered with reference to its endurance under fire, and as an instrument of precision,

\* Report of the Chief of Ordnance, United States Army, for 1893.

is required to support the strains to which it is subjected without deformation; that is, the strength should suffice to confine the strains within the *elastic limit* of the material. Otherwise weakness will be made evident by enlargement of the bore from the *tangential strain*, yielding in the direction of its length due to the *longitudinal strain*, or by bending due to strains which may result in "drooping of the muzzle." As regards the capacity of a gun to sustain a known force of discharge, therefore, the three important points to be considered separately are that within the elastic limit of the material it shall possess sufficient *tangential* and *longitudinal* resistances, and *stiffness* or resistance to bending.

The *tangential* resistance which opposes the bursting effort is relatively of greater importance, since it meets the greatest strain in the material, and incidentally determines the thickness of wall and the outline of the gun.

It is thus the principal element in economy of structure. The study of this resistance has received more attention than either of the others, and it fortunately admits of a completeness of solution in the built-up construction that fulfills every apparent requirement of a problem wherein a nice adjustment of factors is most desirable.

The *longitudinal* strain is chiefly due to the pressure on the bottom of the bore, and it is not difficult to provide for this in the usual methods of construction within dimensions required for and without sacrifice of the tangential resistance.

In respect to *stiffness*, the gun constitutes a beam supported by its trunnions at its center of gravity, approximately two fifths of the length from the breech. The forces operating to bend the chase are its own weight, but especially the bending-moment produced by the accelerated velocity of recoil, which moment increases with the angle between the axis of the gun in elevation and the direction of recoil as guided by the slides of the gun-carriage. The tendency is always to produce drooping of the muzzle, and has been observed notably in the 110-ton English guns of recent date. Although an insignificant factor in the old-style short guns, it has now, in view of the greatly increased length of guns and the present tendency to a still greater increase, become a very important matter, and deserves closer investigation than it apparently has received as yet, and possibly some exact rules to establish the requisite factor of safety in different modes of construction may be deduced or determined by experiment.

**TANGENTIAL RESISTANCE.** The gun being considered of homogeneous material, let  $\theta$  and  $\rho$  represent the elastic limit of the metal under extension and compression, respectively;  $R_0$  and  $R_1$ , the interior and exterior radii of the gun;  $P$ , the resistance to bursting-effort, or the interior pressure per unit of surface that the gun will support without passing the elastic limit of the material. Understanding by a *simple* gun one composed of a single tube without initial

tension, and by a *compound* gun one composed either of a simple tube with initial tension or a built-up construction, the value of  $P$  for different cases is given by the formula:

$$\text{Simple gun. Tangential resistance. } \left\{ \begin{array}{l} P = \frac{3(R_1^2 - R_0^2)}{4R_1^2 + 2R_0^2} \theta \end{array} \right. \quad (1)$$

$$\text{Compound gun. } \left\{ \begin{array}{l} \text{Tangential resistance. } \left\{ \begin{array}{l} P = \frac{3(R_1^2 - R_0^2)}{4R_1^2 + 2R_0^2} (\rho + \theta) \end{array} \right. \quad (2) \\ \text{or when } \theta = \rho \end{array} \right.$$

$$\text{Compound gun. } \left\{ \begin{array}{l} P = \frac{3(R_1^2 - R_0^2)}{2R_0^2 + R_1^2} \theta \end{array} \right. \quad (3)$$

$$\text{Compound gun. } \left\{ \begin{array}{l} \text{Radial resistance. } \left\{ \begin{array}{l} P = \frac{3(R_1^2 - R_0^2)}{2R_1^2 + R_0^2} \theta \end{array} \right. \quad (4) \end{array} \right.$$

These formulas embody the principle that the resistance is limited by the displacement of the metal at the surface of the bore where (within the limits of practice) the strain is greatest. The simple tube will fail by tangential extension only. The resistance of the compound tube will be proportionate to its initial compression, and failure under compression may occur either by tangential extension or radial compression, depending upon certain conditions.

If we assume the compound gun to be initially compressed to the limit,  $\rho$ , and assign a series of values to the radii, such as to represent guns with varying thicknesses of wall expressed in terms of the interior diameter or caliber ( $2R_0$ ), the curves of resistance which may thus be plotted are as follows: The *abscissas* represent the thickness ( $R - R_0$ ) of the wall in calibers, and the *ordinates* the multipliers of  $\theta$  and  $\rho$  in the formulas.

The resistance increases with the thickness of wall, but with diminishing increments, which become relatively small after a thickness of from 1 to  $1\frac{1}{4}$  calibers is reached.

The limiting values of  $P$  for an infinite thickness of wall, making  $R_1 = \infty R_0$ , become:

$$\text{Simple gun, } P = 0.75\theta.$$

$$\text{Compound gun. } \left\{ \begin{array}{l} \text{Tangential resistance, } P = 1.5\theta. \\ \text{Radial resistance, } P = \rho. \end{array} \right.$$

The elastic resistance of a simple gun cannot, then, exceed a pressure on the unit of surface equivalent to three fourths of the elastic limit of the metal; 84 per cent of the possible strength is attained with a thickness of 1 caliber and 91 per cent with  $1\frac{1}{2}$  calibers.

The proportionately greater strength of the relatively thin tube is due to the distribution of the tangential strains throughout the thickness of the wall. In a thick, simple tube subjected to interior pressure, the circumferential tensions decrease rapidly from the bore outwards, and the outer portions render relatively little assistance.

With decrease of thickness the resistance of the outer fibers is more fully developed, and the same conditions of resistance are approached as by the application of initial tension in compound cylinders.

The two upper curves (Fig. 1,) represent the resistance of a compound gun under the conditions that the bore is initially compressed to the full elastic limit, and that  $\rho = \theta$ . These conditions are taken for purposes of illustration, and

because it is usual, in steel constructions, to consider  $\theta = \rho$ . It is not practicable to derive the benefit of full initial tension from a less thickness than 0.6473 caliber; hence these curves are broken (imaginary) within that thickness. To such failing cases the general formula (2) would be applicable in introducing determined values for  $\rho$  and  $\theta$  considered as working-limits, the value of  $P$  being then equal to the product of the sum ( $\rho + \theta$ ) into the multipliers for the curve of tangential resistance, simple gun.

Considering the full curves as shown, the tangential resistance of the compound gun is just double that of the simple gun, and the limit of elastic strength is equivalent to 1.5 times the elastic limit of the metal under extension. The curve of radial resistance lies below the other beyond the point which marks a thickness of about 0.29 caliber, and should therefore for a greater thickness of wall be taken as the true

of the bursting effort in a compound gun may, as in a simple gun, be confined to the tangential strains.

**INITIAL TENSION.** The principle of initial tension is embodied in the law of *tangential* strains, and the manner in which it acts to increase the resistance to interior pressure is the same in a single tube as in a built-up gun.

The difference is principally in the mode of application; being, in the one case, concerned with the cylindrical laminae of the single cylinder, and in the other, with the separate simple cylinders of the built-up construction. A maximum resistance corresponds to such an arrangement of the system that when the interior pressure, which determines this resistance, is applied, all the members will simultaneously be strained tangentially to their elastic limit, and it is the object of initial tension to secure this arrangement, as nearly as may be practicable, in the different plans of construction.

*Fig. 1. Elastic resistance of guns.*

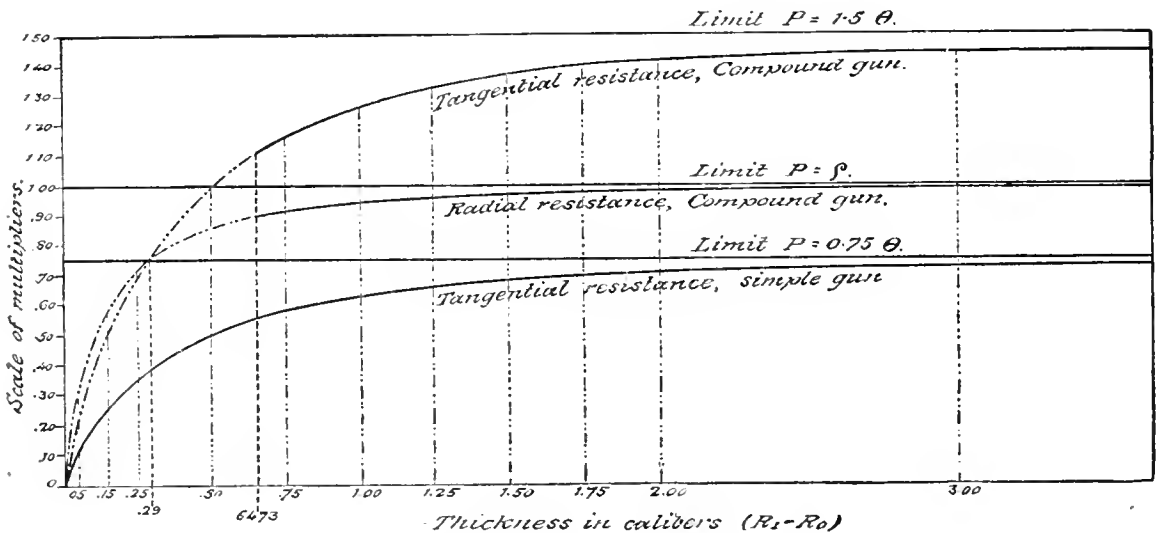

curve of resistance; that is, the elastic resistance of a compound gun, theoretically, is limited to a pressure on the unit of surface equivalent to the elastic limit of the metal under compression.

In computing the shrinkages for a built-up gun, it is the general practice to consider the value obtained for the tangential rather than the radial resistance, as giving a more favorable arrangement of the system as a whole. The radial resistance can be computed finally when all other conditions are fixed, and if it is found to be less than the tangential, then it may be put down as the *elastic* resistance of the gun. In practice, however, this last operation is frequently omitted, and the tangential value alone is given. This may be defended upon the ground, already discussed, that the strength, as estimated by the formula for radial resistance, really is underrated, and hence the (greater) tangential value may be taken as more nearly the true one. In view of these considerations, general discussion

In a single tube the curve of initial tension is continuous, and the principle may be illustrated as follows:

In Fig. 2 is shown the case of a cylinder 0.6473 caliber in thickness; hence  $R_1 = 2.2946R_0$ , and formula (3),  $P = 1.11\theta$ .

Given a metal with equal elastic resistance under compression and extension ( $\rho = \theta$ ), a cylinder of this dimension illustrates, in accordance with the law of tangential strains, the fullest extent to which the principle of initial tension can be utilized.

Its remarkable properties may be otherwise stated, that it fixes for a required resistance the minimum elastic limit of metal that can be fully utilized to procure that resistance. Again, having a metal of given strength, it fixes the maximum thickness that will fully utilize the elastic limit, or, otherwise stated, the thickness up to which the resistance of a cylinder may be made, substantially, directly proportional to its thickness, and beyond which the increase of resistance



will be disproportionate to the thickness in a rapidly diminishing ratio; hence it may be called the cylinder of maximum utility.

For example, let it be required to construct a cylinder having a bore of eight inches which will support an interior pressure of 40,950 pounds per square inch, then, from what precedes,  $2R_0 = 8 \therefore R_0 = 4$ ,  $R_1 = 2.2946 R_0 \therefore R_1 = 9.1784$ ;  $2R_1 = 18,3568$ . Also, the required elastic strength of metal will not be more than  $\rho = \theta = P \div 1.11 = 45,000$

The case taken exemplifies the particular one wherein, the bore being initially compressed to the elastic limit, on the application of the interior pressure, the tangential strains increase until they are uniform throughout the thickness of the wall,

The curve of pressure descends from 49,950 at the surface of the bore to zero at the exterior surface. No other thickness of wall will fulfill these special conditions, which explains the reason for the resistance of a compound gun in Fig. 1. See p. 1487.

Observing that the curve of initial tension is convex upward, if the wall were thicker, the curve of extensions would pass the horizontal stage, and become convex downward, when, under the action of P, the limit  $\theta$  was reached at the surface of the bore, whilst toward the exterior the extensions would be less than  $\theta$ . The value of P would, of course, derive a certain increase from the increase of thickness. If  $\rho$  were greater than  $\theta$  initially, the proportion would be restored, and for this

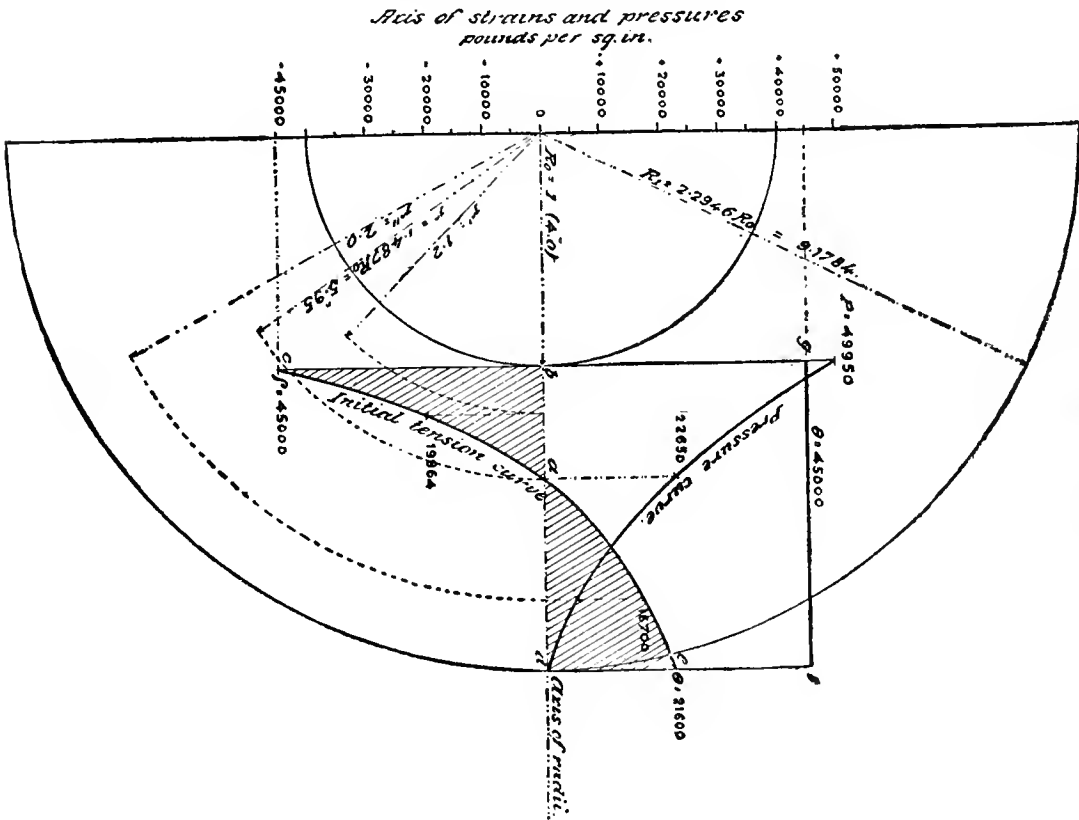

Fig. 2. Initial tension in solid guns

and at the same moment equal to the elastic limit of the metal. These conditions evidently give the maximum utilization of material, since every fiber of the metal is exerting its full elastic resistance. The curve of initial tension extends from 45,000 compression at the surface of the bore to 21,600 extension at the exterior surface, crossing the axis of radii at the neutral point, *a*, where  $r = 1.487 \times R_0 = 5.95$  inches. The areas of compression, *abc*, and of extension, *ade*, represent the work of the two forces in equilibrium, system at rest. The horizontal line indicated by  $\theta = 45,000$  represents the changed position of the curve of initial tension, or the state of extension of the wall during the application of the maximum interior pressure, and rectangle *bdfg* is the strain-area of the system in action.

condition a cylinder of greater thickness than 0.6473 could be brought to the condition of uniform extension.

On the other hand, if the wall were thinner than 0.6473 caliber, with the full initial compression  $\rho = \theta$  given, the initial extensions at the exterior would be proportionately greater than in the example taken; the curve of extensions would remain convex upward under the action of P, and the limit of resistance would be reached where the extensions at the exterior became equal to  $\theta$ , whilst toward the interior they would be less than  $\theta$ . But if  $\rho$  be taken less than  $\theta$  initially, the proportions would be restored; and as this is an entirely supposable case, it follows that the condition of uniform extension under the action of an interior pressure can be secured in a cylinder

of less thickness than 0.6473 caliber, the values of  $\rho$  decreasing with the thickness. In any case, however, the value of P is directly proportional to the sum  $\rho + \theta$ , formula (2); and the series of values for P obtained in this way for varying thicknesses below 0.6473 caliber would also be substantially directly proportional to the thickness of cylinder for a constant value of  $\theta$ .

The only example of solid tubes at present manufactured with initial tension for use in gun-constructon in this country are the cast-iron bodies for the steel-hooped 12-inch mortars. These bodies are cast hollow, on the Rodman plan, and initial tension is produced by cooling with water, through a core placed in the casting-mold. The actual initial tension is determined for each casting by cutting thin rings of metal from near the bore and outer surface. Diameters of the rings are measured before and after the separation, to determine the strains, whether positive or negative, by which the ring was held in restraint. Calling the original diameter D, and its measured expansion or contraction on removal d, we have

$$\frac{D}{+d} E = \rho \quad \frac{D}{-d} E = \theta$$

E being the modulus of elasticity, these express the tangential strains existing in the castings at the place from which the ring was taken. The value of  $\rho$  thus determined for the ring next the bore is used in connection with the general formula (2) in estimating the resistance of the mortar.

The observed tangential extension in the rings taken from near the exterior of these castings is less than it should be, owing to the cooling which cannot be prevented at the exterior surface, and the process produces an irregular, though beneficial state, of initial tension. To complete these rifled mortars, the cast-iron body is strengthened by shrinking on a double row of steel hoops, which extend from the breech to a distance forward of the trunnion-ring.

MODES OF CONSTRUCTION. In presence of the necessity for employing initial tension in modern high-powered steel guns, many good reasons are adduced for discarding the solid in favor of the built-up construction. The difficulties with the solid construction are almost wholly mechanical, but we are none the less far short of being in a position to overcome them; its adoption, although desirable, must wait until the larger masses of steel can be made and treated so as to insure uniformity and combined physical qualities of material equal to those secured in the smaller forgings, and further, until a measure is devised for producing a desirable state of initial tension with certainty and regularity, whilst avoiding the local and irregular strains of great intensity, which are apt to occur and make the result rather more detrimental than otherwise. On the other hand, the smaller parts used in the built-up construction do admit of excellence in the material, and the method affords the means of securing the greatest strength of structure com-

patible with the quality and weight of metal contained. Excepting for small arms and some special classes of light cannon to which the principle of the simple tube is applicable, this method is now universally employed.

Two schools are represented, which differ chiefly in the practical application of the principles involved. The *forged steel gun*, made throughout of cylinders of a determinate size, has for advocates those who will not depart from a fundamental principle, that none of the strains to which the structure is subjected shall exceed the elastic limit of the material, who also seek to reduce the numbers of parts and solidify the structure in measure as the art of steel-forging manufacture progresses, and depend likewise upon improvements made in the physical qualities of the forgings to increase the resistance and power of the gun within given limits of weight and dimensions.

It is noticeable, in the history of this type of gun, that the length of the cylinders surrounding the tube have been steadily increased from its first conception, and its legitimate finality is a gun, made, if not of one simple cylinder in each layer, at least so nearly so as to meet the requirements for longitudinal stiffness, and minimize the cost of production in pace with increased length of bore.

The *wire-wound gun* is advocated for the high elastic properties of metal attained by still further comminution of material in manufacture, and it is sought, by various combinations of such small parts, to utilize their intrinsic properties in resisting the strains in the gun, and thus enable the use of correspondingly high powder-pressures. When this principle is carried to its legitimate conclusion, it naturally brings about a multiplication of parts and complication of structure that enhance the difficulties, if not the cost, of manufacture.

On this ground it might not be objected to, provided there be a commensurate gain in power of gun. There is a limit, however, to the division of parts which may be made in a gun whilst preserving its integrity, and the difficulty arises in applying the small parts, with their high elastic properties, in every part of the structure. Hence we find that in most designs of wire guns this principle is sacrificed in part, and the core upon which the wire is wound, or an integral part of it, is composed of a tube forged substantially the same as is used in the forged gun. Based upon general principles, the elastic tangential strength of a wire gun so constructed cannot exceed that of the forged gun.

In effect, those designers of wire guns who adhere to the same form of tube as used in the forged gun, but aim for a higher tangential resistance, do avowedly ignore the rule which confined the initial compression of bore to the elastic limit of the material, and introduce a greater state of compression, which, according to the formulæ of construction, will cause the metal at the surface of the bore to be tangentially compressed beyond the elastic limit. What effect this may have upon

the life of the gun can be determined only by endurance-tests, which should be made with pressures corresponding to the high resistance claimed. It may be conceived, however, that such a condition would be unfavorable in metal subjected to repeated strains, and may facilitate erosion.

Another matter to be considered in connection with the question of *wire-wound* versus the *forged* cylinder construction is the erosion of bore, as limiting the useful powder-pressure. The endurance-tests of the built-up forged guns have shown that the wear and power of the gun are limited by erosion, and that the resistance of these guns is more than sufficient at present to withstand the pressures or other causes which determine this erosion. I conclude that, on the whole, there is little to be gained in attempting to make wire guns to be professedly stronger tangentially than the forged gun. And if equal strength only

nealed. The forgings are finished and assembled at the government gun factories, there being an extensive plant at Watervliet arsenal, under the army ordnance department, and a second, under the Navy Bureau at the Washington navy-yard.

The proportion of the available tangential resistance called into play varies from about seventy per cent in the sea-coast guns to ninety per cent in the field and siege guns.

The radial resistance is in all cases in excess of the actual pressures. Its value in the heavy sea-coast guns is nearly forty thousand pounds. This is considered a safe pressure for repeated firings, —one which will not cause the elastic limit of the material to be exceeded in any respect, and is from two thousand to three thousand pounds in excess of the powder-pressures. It will be remembered, of course, that these figures relate to the *elastic* strength of the guns, and not to actual rupture; they in no sense involve the work which

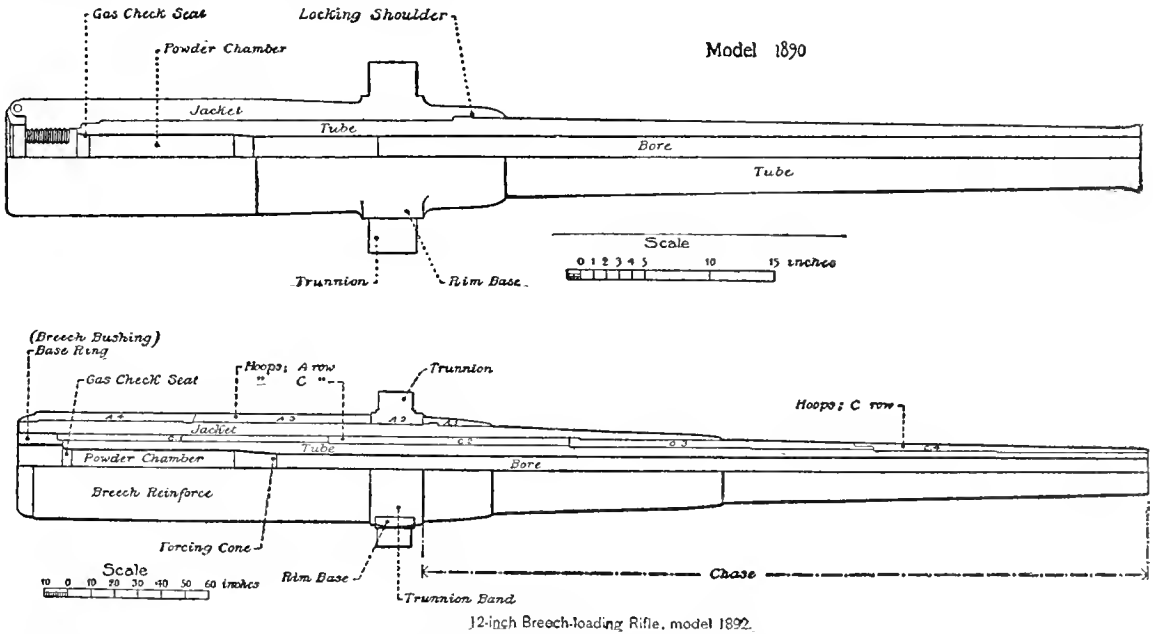

is aimed at, then the forged gun has the advantage of being inherently the more solid and stiffer construction.

**SERVICE-GUNS OF THE UNITED STATES.** The guns for both land and naval service are of the built-up, forged-steel constructions, with slotted screw breech closure. Exceptions as to mode of construction occur in the 3.6-inch and 7-inch rifled mortars of the land-service, which, by reason of the low powder-pressures employed, are composed of a single tube of forged steel, and in one pattern of the 12-inch rifled mortar (sea-coast), which comprises a cast-iron body, reinforced by two layers of forged steel hoops.

The gun-steel forgings are purchased from private manufacturers, being principally supplied from the great plants of Bethlehem and Midvale. The steel is made by the open-hearth process, and, after casting, the ingots are forged, rough-bored and turned, then oil-tempered and an-

would have to be done by the powder-pressure in stretching the very ductile metal through the range between its elastic limit and the limit of rupture.

The use of longer cylinders requires increased care and appliances for the shrinkage operations, to avoid undue longitudinal strains, arising from unequal "gripping" of the heated pieces on cooling. It is aimed, in assembling the guns, to produce progressive contact of the two surfaces by artificial means of cooling carried evenly along from end to end.

Experiment has shown the remarkable conformity of results obtained in the actual manufacture of these guns with those indicated by the formulas applied in their construction. Each gun is assembled with a determined set of shrinkage values, based upon the qualities of metal contained. The estimation of these values is facilitated in dealing with all steel guns in which a

uniform value may be taken for the modulus of elasticity of the steel throughout the structure. Taking this modulus in connection with the minimum elastic properties of the metal, it is the practice, in the United States army ordnance department, to deduce for each kind and caliber of gun a typical set of shrinkages to be used in the construction of other similar guns. The resistance computed for the type-gun will be the least of its kind, whilst the higher elastic qualities of the steel generally obtained will result in giving a greater resistance without necessitating any change of prescribed shrinkages.

The tests of the metal show that a uniform value of thirty million pounds may be taken, without sensible error, to represent the modulus of elasticity (E) of the steel throughout the series.

The average ultimate physical properties of the metal are annexed in the following table:

CANNON-FORGINGS.	SPECIMEN.		ELASTIC LIMITS.		TENSILE STRENGTH.	ELONGATION AFTER RUPTURE.	CONTRACTION OF AREA.
	Length.	Diameter.	Load $\theta = P.$	Extension, per inch. $\theta + E.$			
	Inches.	Inches.	Pounds □ "	Thousandths.			
FIELD—							
Tubes-----	2	0.505	44,800	1.4933	86,000	22	40
Jackets-----	2	0.505	49,280	1.6427	93,000	20	35
SIEGE—							
Tubes-----	3	0.564	42,000	1.4000	78,000	18	30
Jackets-----	3	0.564	48,160	1.6053	86,000	16	27
Hoops-----	3	0.564	48,160	1.6053	99,000	18	--
SEA-COAST—							
Tubes-----	3	0.564	41,440	1.3813	78,000	17	30
Jackets-----	3	0.564	43,680	1.4560	85,000	16	27
HOOPS—							
Inner-----	3	0.564	50,400	1.6800	93,000	13	--
Outer-----	4	0.564	45,920	1.5307	93,000	13	--

The formulas employed are based upon the principle that the displacement of metal fiber in the structure, due to the combined action of the stresses of tension and pressure, shall at no place exceed the elastic limit of displacement determined by free tests of the metal. The fundamental formulas are those of Lamé, modified, in their application, from the methods proposed by Major Clavarino of the Italian army.

A general statement regarding the application of the present formulas to determine the resistance and shrinkages for a forged steel built-up gun is as follows: The given quantities are the radial dimensions of the simple cylinders, the modulus of elasticity, and the elastic limits of the metals, the two former being fixed, and the latter independent constants to the extent that any values below the given limits may be substituted. The constants being given, the primary object will be to deduce such shrinkages for the assemblage of the simple cylinders as will put the structure, as a whole, in the best condition to resist the powder-pressure, or to afford a maximum resistance to pressure in the bore. To this end, and in order first to determine the pressures which it

will support, the system is supposed to be completely assembled, and the pressures determined, and thereupon the shrinkages commensurate with such pressures are deduced. It then remains only to apply these shrinkages in assembling the system, in order that the stated conditions of pressure in resistance may be realized.

Two extreme states of equilibrium, corresponding to the limits of strain in the system, must be considered, viz.: 1. The state of action, in which the resistance to pressure in the bore is determined by supposing each simple cylinder subjected to the maximum or at least the greatest useful interior pressure that it will support. This state corresponds to the moment of firing, and the reputed resistance must be fully equal to or greater than the anticipated surface-pressure. 2. The state of rest, which exists when there is no pressure in the bore. This is the normal

state of the system, and the strains are relatively small, except at the surface of the bore, where overcompression is liable to occur, and the limit of strength for the system in this regard will be determined by the consideration that the pressure acting at the first contact-surface upon the exterior of the tube shall not exceed the safe pressure for that cylinder when there is no interior pressure acting.

The sufficiency of the formulas used in these computations has been proved in a number of ways by experiment. It is difficult to state just what pressures are produced in firing, because the means of measuring them are not exact.

However, the many rounds fired from the guns do show that if the powder-pressures, as registered by the pressure-gauges, do not exceed the resistance estimated by the formulas, the guns will not be enlarged.

Much more exact verifications, by means of the measured displacements, are possible, and have been made in connection with numerous shrinkage-tests of hoops, and in building up short sections of different guns in full dimensions.

Particular reference may be made to the section

of an 8-inch gun tested in this way at the West Point foundry in 1885. The section was about eight inches in length and built up of four cylinders. The displacements of diameters and lengths caused by each shrinkage were carefully, measured and in every instance showed a close agreement with the indications of the formulas. For example, the anticipated total compression of the 8-inch bore was 0.0129 inch, and its measured compression 0.0131 inch; the anticipated extension of the exterior of the outer hoop (31.5 inches) was 0.0285 inch, and its measured extension 0.0276 inch. These culminating measurements of the series thus showed a difference of less than two per cent between the actual and anticipated results.

**LONGITUDINAL RESISTANCE.** The longitudinal strain in the breech of the gun on firing is assumed to be uniformly distributed over the cross-section of the jacket, or block-carrying cylinder. Two factors combine to produce this strain; one, the longitudinal pull or elongation,

Its greatest positive value corresponds to  $P_1=0$ ; and, in general, an excess of exterior normal pressure tends to elongate the block-carrying cylinder and increase the direct thrust due to the powder-pressure.

**BREECH-MECHANISM.** Loading at the breech instead of the muzzle is a feature universally adopted for modern guns. The increased complexity of construction is much more than compensated for by greater facility of loading and increased rapidity of fire, together with a better utilization of the powder-charge and higher and more uniform ballistic results.

The essential features of every breech-mechanism, arranged in their order of importance, by which the various forms in use may be distinguished, comprise,—1. A removable block which shall be strong and safe in its connection with the gun when fired; 2. A means of preventing the escape of the powder-gases; and 3. A ready means of manipulating the block. It is highly

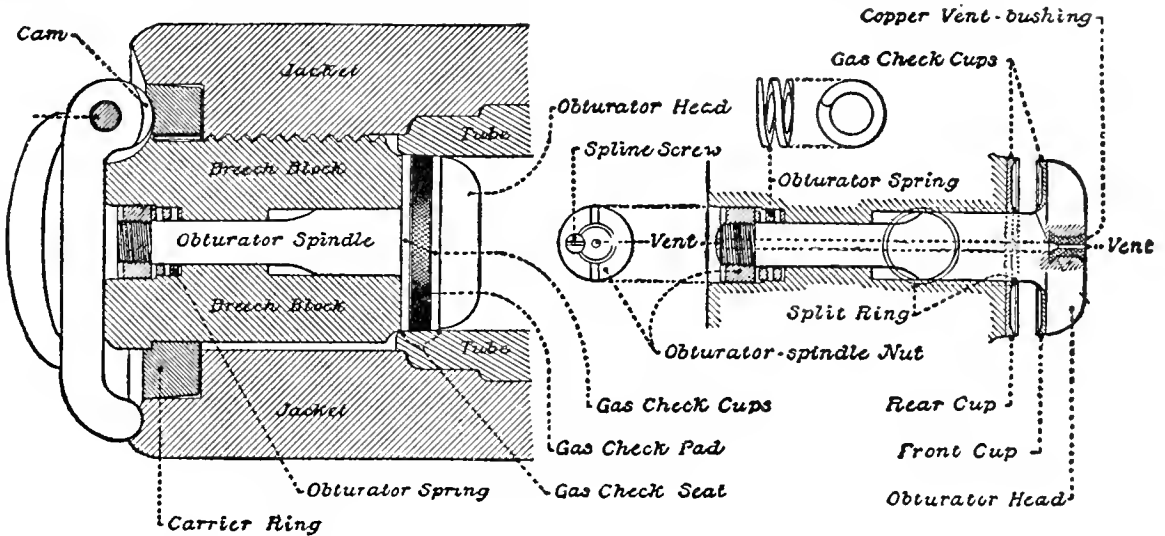

caused by the direct thrust of the pressure in the bore on head of block; and the other, the displacement in longitudinal direction, caused by the pressures which act normally upon the interior and exterior of the jacket. The latter may be either an elongation tending to increase the strain due to the direct thrust, or a contraction tending to diminish it, depending upon the relative intensities of the normal pressures. Employing the common notation to distinguish pressures and radii, the stresses per square inch on cross-section of jacket caused by the two sources of strain indicated are expressed as follows:

$$\text{Direct thrust, } \frac{P_0 R_0^2}{R_2^2 - R_1^2}$$

$$\text{Normal pressures, } \frac{-P_1 R_1^2 + P_2 R_2^2}{3(R_2^2 - R_1^2)}$$

The first expresses the aggregate pressure on head of block, divided by an area of cross-section of jacket. The second expresses a longitudinal stress, which will be positive or negative according as  $P_1 R_1^2 < \text{or} > P_2 R_2^2$ .

important, also, that it should be arranged to prevent premature discharge. The chief distinction, and that which fixes the generic name of the system, lies in the form of the block and the mode of its connection with the gun in resisting the shock of discharge. Thus all the breech-mechanism of the heavier guns in use are classified under two general systems—the screw and the sliding-wedge. Both of them have been previously described. The screw system is adopted in the United States for all cannon, except those in which metallic cases are to be employed.

The De Bange gas-check has been adopted as the standard, although the Freyre check has been experimented with, and used with most excellent satisfaction.

The latter is simple in construction, and takes up considerable less powder-space; on the other hand, the De Bange check is less likely to be damaged, and to that extent is preferable. The parts of both are replaced easily when injured. In the De Bange (Fig. 5) the head of the spindle

is shaped like a mushroom, and in the rear of it, slipped over the shank of the spindle, is a ring or pad of plastic material, composed of asbestos and tallow, formed in a die under great pressure. It is covered with canvas, and protected front and rear by the gas-check cups. These are made of special steel of high elasticity, are slightly smaller than the bore, to avoid contact, and are lined with cups of sheet-copper to prevent cutting of the pad on the outer surface. A small steel splitting ring is placed over the rear cup around the spindle, to prevent squeezing the pad into this joint. A change has recently been made in the gas-checks for all heavy guns,—siege and sea-coast,—consisting in the omission of the front steel cup and the lips of the rear cup, and substituting therefor split steel rings, to which the pad is made to conform. These split rings constitute a real and marked improvement over the old form of gas-check.

They act, under all pressures, with readiness and certainty, and without sticking or causing any obstruction to the free movement of the block in opening the breech after firing. During firing, owing to its plastic nature, the pad presses out against the gas-check seat and inward against the obturator spindle-stem so as to prevent the passage of the gas.

The spindle is perforated axially for the vent, through which the charge is ignited by an obturating electric primer placed in the rear end of the spindle. The front end of the vent is bushed with copper, to be removed when worn by erosion. The nut at the rear end of the spindle serves to adjust the initial pressure of the head on the gas-check. It rests on a steel spring, which forms a yielding bearing when the gun is fired, reduces the friction between the nut and its seat when the block is rotated around the spindle in opening, and serves to take up any excess of length of the spindle due to compression of the pad. For the heavier calibers the obturator-spring is replaced by antifricition washers, alternately steel and bronze. These allow the block to rotate around the spindle in making the sixth of a turn for opening, and utilize the power of the screw on the block to start the gas-check from its seat without rotation.

D. W. FLAGLER.

C. H. CLARK.

\*GUNNERY. In so far as the instruments for measuring velocities and pressures are concerned, but few important improvements have been made. In the United States, the Le Boulengé chronograph is now almost exclusively used for obtaining the muzzle-velocities of projectiles, this instrument being simple, easily worked, and quite reliable. The *crusher-gauge* has replaced the *Rodman* for measuring chamber-pressures, its advantages being that it occupies less space, is easier to manipulate, cheaper and simpler in its elements, and is easier to duplicate, while its results are quite as accurate. This instrument is the same in principle as that previously described in the article on GUNMAKING AND GUNNERY, Vol.

• Copyright, 1899, by The Werner Company.

XI, pp. 278 et seq. In construction it has been varied to suit the differing conditions in small arms and heavy guns. The copper cylinders in all cases are initially compressed with a pressure a little below that expected in the chamber. This results in giving only slight motion to the piston, the records obtained being lower and more reliable. The following record illustrates this fact:

*Record of 20 shots with 30-caliber-pressure. Cartridges, hand-loaded, with charges of equal weight, smokeless powder.*

I. CYLINDERS INITIALLY COMPRESSED.  
MEAN 31,800 POUNDS.

No. OF SHOT.	VELOCITY AT 53 FEET PER SECOND.	LENGTH OF CYLINDER.		DECREASE IN CYLINDER.	PRESSURES INDICATED.	INCREASE OVER INITIAL COMPRESSION.
		Before.	After.			
		Inches.	Inches.	Inches.	Lbs. per sq. in.	Lbs.
1	1,920	0.4603	0.4598	0.0005	33,100	234
2	1,944	0.4636	0.4617	0.0019	32,233	833
3	1,946	0.4612	0.4607	0.0005	32,700	250
4	1,950	0.4652	0.4637	0.0015	31,350	700
5	1,944	0.4616	0.4607	0.0009	32,700	434
6	1,920	0.4646	0.4630	0.0016	31,650	700
7	1,923	0.4612	0.4602	0.0010	32,900	450
8	1,966	0.4637	0.4627	0.0010	31,800	450
9	1,938	0.4616	0.4607	0.0009	32,700	434
10	1,948	0.4622	0.4600	0.0022	33,000	1,000
	1,930.9 mean.				32,413 mean.	

II. CYLINDERS NOT INITIALLY COMPRESSED.

No. OF SHOT.	VELOCITY AT 53 FEET PER SECOND.	LENGTH OF CYLINDER.		DECREASE IN CYLINDER.	PRESSURES INDICATED.
		Before.	After.		
		Inches.	Inches.	Inches.	Lbs. per sq. inch.
1	1,946	0.5003	0.4643	0.0360	31,100
2	1,954	0.5005	0.4534	0.0471	35,900
3	1,950	0.5002	0.4542	0.0460	35,575
4	1,978	0.5002	0.4473	0.0529	38,500
5	1,950	0.5003	0.4556	0.0447	35,025
6	1,982	0.5000	0.4468	0.0532	38,700
7	1,944	0.5003	0.4563	0.0440	34,650
8	1,944	0.5002	0.4551	0.0451	35,225
9	1,964	0.5003	0.4533	0.0470	35,925
10	1,956	0.5004	0.4520	0.0484	36,500
	1,950.8 mean.				35,710 mean

It has been found true, generally, that the pressures increase with the velocity. In practice, some difficulty arises from variations in the lots of copper rods as obtained from manufacturers. A careful inspection and gauging is required, and it is necessary to have a reference-table of compressions made for each lot of copper cylinders when finished.

This method gives, within close approximations, the maximum chamber-pressures due to various powders; but it fails to record the comparative rates with which the maxima are reached. A recent gauge, invented abroad, claims to record on a revolving cylinder curves which give not only the maximum pressures, but also indicate the greater or less rapidity of action of the various explosives. No opportunity has as yet been offered to verify these claims in this country.

*Accuracy.* With the breech-loading cannon, im-

proved powder, etc., the conditions of loading will be under much better control, and in consequence but slight variations will occur in muzzle-velocities. The sights have been perfected and entire matériel improved. In field-artillery, target-firing is now conducted to assimilate as nearly as possible the conditions of the battle-field. Practice is held at varying and unknown distances, and the target may be invisible, moving rapidly or alternately appearing and disappearing.

Distances are to be hurriedly estimated or measured with the range-finders, the ranges verified, and time-fuses prepared for the most effective bursts. The projectile mainly depended upon for use against troops will be the *shrapnel*, which has been greatly improved.

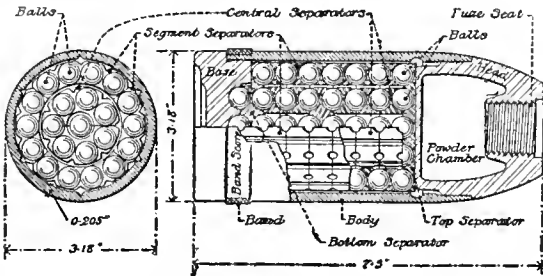

Frankford Arsenal Shrapnel for 3.2-inch Breech-loading Rifle.  
Fig. 1.

Fig. 1 represents the standard shrapnel used in the United States service. It has a body of steel tubing, weakened for fracture by circular and longitudinal grooves cut upon the interior. The cast-iron head and base are screwed into the body, the system being given strength sufficient to withstand the shock of discharge without deformation or rupture. It contains 162 half-inch balls of hardened lead in 8 layers, separated by cast-iron plates fitted to receive the balls. The total number of individual pieces in the shrapnel before bursting is *two hundred*. It is intended to burst the shrapnel in air, a little in front and above the animate target. This is effected by a combination time and percussion fuse, the latter intended to function upon impact in case of failure, for any reason, of the time-device.

Due to the use of smokeless powders, it will be admissible to mass the artillery more in the most effective positions. Owing to the increase of power in all the arms, artillery will open the engagement at distances from 2,700 to 5,400 yards, depending upon the various conditions, and, in general, will probably be able to take a second and decisive position at about two thousand yards. Much greater rapidity of fire will be possible at times when its effectiveness can be assured; curved fire against troops under cover will also be provided for. There seems to be, on the whole, no room for doubt that the next great war will demonstrate in a most decisive and startling way the terribly increased effectiveness, in the field, of the artillery arm.

In the sea-coast service the effective projectile against the armored portions of battle-ships will be

the hollow-forged steel shot, or shell charged with some high explosive. The hostile vessel will be *tracked* in accordance with the general methods already described. Each battery will have its position finder or locator, and from a central point the gunner will be signaled at short intervals by means of disks the distance and azimuth of the hostile object. If the elevations are not also posted, these will be obtained from range-tables. The gunner will also be supplied with data as to the wind-components. With all these, experience on the part of the gunners is alone necessary to insure a greatly increased percentage of effective shots. It may be observed, in closing, that the almost twenty years of comparative peace in Europe and America have resulted in vast improvements in all the terrible enginery of war. The machine age in the *constructive* arts has been well paralleled in those *destructive*.

*Books of Reference.* *Historical Sketch of the Artillery, United States Army* (Birkhimer); reports of the chief of ordnance, United States army; progress reports, United States Naval Bureau; official reports, service journals, etc. D. W. FLAGLER.  
CHAS. H. CLARK.

\*GUNPOWDERS, IMPROVEMENTS IN. Late improvements in gunpowder have tended toward greater uniformity of product, and this is effected more especially by careful analyses of the charcoal, and efforts to regulate its proportions of C, H, and O.

Special powders have increased in number, following the principle, that to obtain best possible results, each piece should have a powder adapted to its peculiar conditions.

COCOA POWDER. This was introduced in Germany in 1882, in the *prismatic* form, as being better adapted for the heavier rifles, giving higher velocities with lower pressures and less smoke than the black variety, although requiring about one fifth more in weight for the charge. These facts are well illustrated in Fig. 1, which represents the comparative pressure-curves obtained in the English 9.2-inch (22-ton) gun, the full curve being for the *black* prismatic and the broken curve for the *brown* powder, the initial velocities being 1708 and 1798 feet per second, respectively.

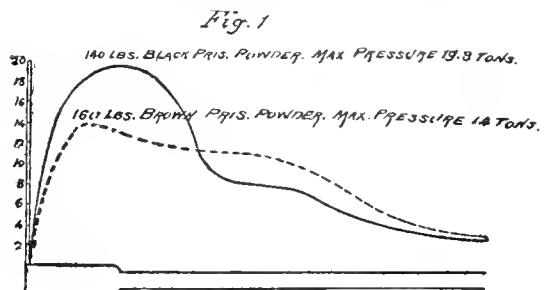

The constituents of the *dry* powder are 79 parts niter, 3 sulphur, and 18 charcoal lightly burned. For the latter, slightly carbonized straw is generally used—the method of carbonizing to the

\* Copyright, 1897, by The Werner Company.

required degree being one of the well-kept secrets of the manufacturers. The lower pressures are attributed to the slower rate of burning, the action being gradual but long-sustained. The brown powder has a larger percentage of moisture, which doubtless favors reduction of pressure in the earlier stages of combustion. If subjected to high heat in storage, however, the moisture is likely to be expelled, and abnormal results follow. Brown or cocoa powder has been found to vary quite regularly with the seasons, requiring, to attain certain results, about three per cent more powder in midwinter and three less in midsummer than necessary in either spring or autumn. It is found more erosive than the black

The brown prismatic is used in the United States for all breech-loading sea-coast cannon, and is manufactured at the Dupont and Peyton factories, for the Atlantic and Pacific coasts respectively.

**SMOKELESS POWDERS.** The recent introduction of successful smokeless powders marks a most important era in the history of ballistic explosives. It was made possible by the advance in knowledge of the manufacture of stable high explosives, and the necessity became evident upon the introduction of rapid-firing guns and repeating-rifles. Higher velocities were demanded than the black or brown powders could give within the limits as to pressure, and to retain advantage of increased rapidity of fire it became necessary to do away with the dense smoke-volumes of the old explosive. Fortunately, increased power and smokelessness are most intimately associated. Complete absence of smoke means complete resolution into gaseous products, and hence higher power.

Earlier but unsuccessful attempts to obtain a smokeless explosive for ballistic purposes are considered under the subject of GUN COTTON, Vol. XI, pp. 277-278. The late revival dates from about 1885. Two most important steps leading up to this were the improved processes of gun-cotton manufacture, by which is given greater assurance of a stable product, and then the later introduction, in 1875, of Nobel's *blasting-gelatine*, in which was accomplished both the gelatinization of the gun-cotton and the fixing of the nitroglycerine, with modification of the properties of both.

The new smokeless powders have, it is true, met with many reverses, but the tendency toward their adoption in one form or another has proved irresistible. The principal nations are now using it almost exclusively for small arms and rapid-fire guns, and are experimenting with it for field and heavy cannon. Its complete success seems at present beyond question.

Before classifying the powders generally accepted as *smokeless*, mention should be made of certain varieties sometimes so classed, though they may perhaps better be designated as *semi-smokeless*. These include certain nitrate mixtures other than ordinary gunpowder, and picrate mixtures with minor smoke-producing ingredients.

In the former, ammonium nitrate ( $\text{NH}_4\text{NO}_3$ ), is prominent, yielding products which, with the

exception of water vapor, are entirely gaseous. To obtain with it the desired ballistic results, the introduction of a certain proportion of potassium nitrate is found necessary, and the latter insures smoke from the potassium carbonate formed on explosion. The ammonium nitrate powders absorb moisture readily, and precautions have to be taken to avoid exposure. Having naturally more water than even the brown powders, these compositions, when subjected, even in air-tight cases, to heat for considerable periods, are apt to give irregular results due to expulsion of moisture from portions of the powder-masses.

As an example, the composition of the Amide powder (1885) is given as follows:

	PER CENT.
Potassium nitrate-----	46
Ammonium nitrate -----	36
Charcoal-----	18

The volume of gases produced by this powder would be very large, and its rate of burning probably slow due to the absence of sulphur. It gives thin smoke and little residue, but readily absorbs moisture.

The picrates of potassium and ammonium have been much used in explosive preparations, giving more powerful mixtures than the ordinary gunpowder. The Brugère powder consists of 54 parts of ammonium picrate and 46 of potassium nitrate. It is reported as stable, safe to manufacture and transport, but is rather expensive. It gave good results in the Chassepot rifle, yielding but little smoke and slight residue. It is practically the same in composition as the "picric" powder of Abel.

Potassium nitrate being present in all these picric powders, there must be, as already stated, smoke resulting from the combustion, though not approaching in density that from ordinary powder.

The true *smokeless powders* as now accepted can be divided into three classes:

1. Powders in which nitrocellulose is used alone or in combination with substances other than nitroglycerine. Cotton is greatly preferred for obtaining the purer cellulose, and either the *trinitro* or *dinitro* compounds are used, these being commonly referred to as the *insoluble* and *soluble* varieties, although the former is soluble in acetic ether or acetone. The action of the solvent is to convert the cellulose into a tough, horny material.

2. Powders in which a mixture of *nitro-glycerine* and *nitro-cellulose* (dinitro or trinitro) is transformed into a similar horn-like substance, either with or without the aid of a solvent.

3. Powders which contain nitro-derivatives of the aromatic hydrocarbons either by themselves or in connection with nitrocellulose; as, for instance, the mixture of the latter with nitrobenzene as a solvent.

Classes 1 and 2 are complicated by the introduction of an endless variety of modifying agents, introduced for a number of purposes, such as to increase the power, retard combustion, insure stability, give easier granulation, etc. The preparation of powders having nitrocellulose for a



base is founded upon the property which this substance possesses of becoming, when treated with a proper solvent, a gelatinous mass easily convertible into sheets, strings, or grains, which can, by a simple process of drying, be freed from the liquid solvent. The nitrocellulose does not contain sufficient O to completely oxidize the C to CO<sup>2</sup>. To remedy this, and as slowing agents, oxidizing-salts are sometimes added. The pure nitrocellulose powders give high pressure as a rule, and in many cases considerable irregularity. These are also difficult to ignite, and are considered more subject to decomposition in consequence of the varying degrees of nitration attained in the cellulose.

The pure tri-nitrocellulose is stable, but commercially it is always found with varying proportions of the less nitrated and less stable varieties. The pure nitro-cellulose powders are also more expensive.

In the second class, the nitroglycerine supplies to the nitrocellulose the deficient oxygen, the heat of combustion is extremely high, and the ballistic results remarkable. The permissible range of proportions is a wide one, but as the proportion of nitroglycerine becomes high, the grains becomes soft, there is a possibility of exudation when subject to heat or pressure, and the erosion of the bore becomes more pronounced. When the proportion of nitroglycerine is low, the product becomes tougher, more difficult to granulate, the pressures are higher, and the presence of a slowing agent more imperative. The following are prominent examples:

*Ballistite.*

40 parts dinitro or *collodion* cotton.

60 parts nitroglycerine.

With the addition of about 1 per cent of aniline.

*Cordite.*

37 parts gun cotton, }  
58 parts nitroglycerine, } dissolved by 19.2 parts  
5 parts vaseline, } of acetone.

The manufacture of a smokeless powder to meet the high requirements of modern times is accompanied with many difficulties. This will be seen by a consideration of the essential requisites, as follows:

1. *Approximate smokelessness of the products of combustion.* Perfect absence of smoke is hardly possible to be attained, but a sufficient measure of success has been met with in most varieties to satisfy this condition. The powder is mostly converted into permanent gases and steam. There results usually, on firing, a "very thin bluish smoke," "filmy vapor," or "dusty puff," all of which quickly dissipate.

2. *Give high and uniform velocities with safe and regular pressures.* Comparative tests show that the smokeless powders possess far better ballistic qualities than the ordinary powder, much smaller charges being required to produce equal velocities, while with equal chamber-pressures the velocities are much higher. The action is gradual, but sustained, giving lower chamber-pressures,

but higher pressures along the chase. The rapidity of combustion in many cases is checked by a slowing agent, such as mineral jelly or castor-oil. Camphor has been used; but, being volatile, it is not looked upon favorably for the purpose. Excessive pressures with certain brands have certainly been obtained, while others are known to be extremely uniform. It cannot be stated that *detonation* has occurred in any case during all the tests of its many varieties. This fact is strange when it is considered that in many varieties the principal ingredients are high explosives, each capable, when separate, of the most destructive detonation.

3. *Possess chemical and physical stability under varying conditions of moisture, temperature and age.* Many powders have failed to comply with these conditions, becoming unstable with varying temperatures and during prolonged storage. The ingredients in some cases are subject to chemical instability, and constant vigilance is necessary to guard against the introduction of any not above suspicion. The powders are subjected to severe stability-tests, as a rule, before acceptance, but this does not in all cases insure against spontaneous decomposition at some period after. The result of slow decomposition being usually nitrous fumes, it is a common precaution to introduce into the composition a small percentage of urea crystals. This combines directly at all temperatures with the smallest traces of nitrous acid the instant it is evolved, resulting in the formation of water and carbonic acid, and the decomposition thus is checked. The urea seems an ideal agent for this purpose. In powders with a very large percentage of nitroglycerine in composition, there is a tendency to exude when acted upon by heat or pressure. Such large percentages for this and other reasons are no longer considered as permissible.

Many varieties of smokeless powder have a hard, firm grain, with almost entire absence of dust. A soft and friable grain is likely to give at times abnormal pressures, and is a serious defect. Too great softness of grains also favors a tendency to agglomerate or "cake" in storage. As to effects of moisture, there is a great diversity. Some grains may be soaked in water for long periods and afterward dried, without the slightest change in explosive force. On the other hand, some varieties contain salts which are affected greatly by exposure to moisture.

4. *It must not cause excessive fouling, either from powder residue or metallic from the projectile or its envelope.* The small-caliber arms with rapid twist of rifling are especially difficult to keep clean, and any hard, dry residue gives annoyance. Most smokeless powders do not leave an appreciable residue, and the bore remains quite clean after firing; but traces of nitric compounds are apt to remain, which should in all cases be removed by careful cleaning. Otherwise the residue combined with the moisture of the air will attack the surface of the bore.

5. *It must not be sensitive to explosion from fric-*

tion or shock, nor yet very difficult to ignite when acted upon by the primer. A prominent characteristic of the smokeless powders is the remarkable insensitiveness to explosion. Ignited in the open air, combustion takes place often with much heat and brilliant flame, but without the characteristics of an explosion. This is found true for large as well as small quantities. Confinement is necessary to develop the explosive force.

It proves troublesome with many varieties, to provide a primer of sufficient strength to explode without hang or miss fires, especially with low density of loading. Strong primers generally are used, with special composition which insures the development of considerable heat. The poor combustibility has also the effect of preventing the entire charge from burning. After firing, it is often found that quite a number of grains not entirely consumed remain in the bore and cartridge case.

6. *The manufacture should not be attended with great difficulty or excessive danger.* While the difficulties met with have been numerous, the dangers have been those customary in the manufacture of the high explosives.

7. *The products of explosion must be comparatively free from noxious or irrespirable gases, and also from those which would rapidly corrode or erode the gun.* As to the former, this must be taken within limits. Cundill states that "there is no explosive within my knowledge, in practical use which, when exploded in a confined space, does not give off noxious or deleterious gases."

It has been found that in powders containing high percentages of nitroglycerine, there is, especially in rapid firing, a considerable erosion of the metal of the bore, more marked about the seat of the projectile, and this action increases very rapidly after a certain stage, soon rendering the arm unserviceable. With cordite, in the English small arms, a limit of life for the piece is reported as having been fixed at three thousand rounds. Tests in this country with similar powders confirm these results. On the other hand, it is claimed for a certain small-arm nitrocellulose powder (Rottweil), which contains no nitroglycerine, that satisfactory accuracy has been obtained after firing over twelve thousand rounds. In this country an instance is on record at the Frankford arsenal cartridge factory of favorable results from a small arm after more than thirteen thousand rounds fired with Peyton powder, which contains a considerable percentage of nitroglycerine. The result has been, in most cases, to limit the percentage of nitroglycerine. The latter favors low pressures and easy ignition, and a certain percentage, in consequence, is considered desirable, especially in the larger guns. Other things being equal, for small-arms, that powder is preferred which heats the barrel less in rapid firing.

8. *There must be entire freedom from chemical action in connection with the metallic cartridge-case, used with small arms and rapid-firing guns.*

GENERAL CONSIDERATIONS. In the manufacture of smokeless powders it has been found dif-

ficult to insure uniformity of product from lot to lot, the varying conditions of ingredients and manufacture being difficult to control.

A special smokeless powder is required for each variation in caliber, while a certain granulation of black powder is often used successfully in a variety of calibers. As an example, in tests made, using the same smokeless powder, for equal velocities in two rifles, varying in caliber from 0".314 to 0".299, the pressures were found to rise from 34,135 pounds per square inch to 45,513 pounds.

For small arms the powders are at present made either in the shape of grains, flakes, cubes or cords.

For cannon are used large square flakes, cubes, or perforated cylinders, the latter being for the larger calibers in some cases the full length of the chamber and of considerable diameter.

Space is too limited to consider the tactical results of the introduction of smokeless powders. To see is considered of the first importance in battle, and after that, *not to be seen.* It is assumed now that the army using smokeless powder will see better, aim better, carry out its fire-discipline more perfectly, and produce a far greater fire-effect.

It will also be less subject to observation by the enemy.

*References.* *The Manufacture of Explosives*, Oscar Guttman (1895); *A Dictionary of Explosives*, Maj. J. P. Cundill (corrected to 1890); scientific journals, official reports and miscellaneous notes.

D. W. FLAGLER.  
CHAS. H. CLARK.

GUNNEL OR BUTTERFISH, popular names of small, eel-like fishes, of the genus *Centronotus*. They live among the seaweed near the shore, and are used as bait by the fishermen.

GUNNISON, the capital of Gunnison County, Colorado, situated on a river of the same name. It is a railroad junction, and is connected by branch roads with many mining points. Population 1890, 1,105; 1900, 1,200.

GUNPOWDER PLOT. See FAWKES, GUY, Vol. IX, pp. 57-59.

GUNSHOT-WOUNDS. See SURGERY, Vol. XXII, pp. 676, 677.

GUNTER, ARCHIBALD CLAVERING, an American novelist; born in Liverpool, England, Oct. 25, 1847; went to California with his parents when five years old; was educated in England, and graduated at the University College of San Francisco; mining-engineer from 1867 to 1874; stock-broker in San Francisco from 1874 to 1877. In the mean while he had produced several plays; among them, *Cuba* and *Our Reporter*, which were brought out in San Francisco. In 1877 he went to New York, and there wrote the play, *Two Nights in Rome*, produced in New York at the Union Square Theater, August, 1889. His first novel, *Mr. Barnes of New York*, was published in 1887, and had a great success, being translated into several languages. Since then he has written *Mr. Potter of Texas; That Frenchman; Miss No-*

*body of Nowhere; Miss Dividends; and The Ladies' Juggernaut.* He publishes his own works.

GÜNTHER, ALBERT CHARLES LEWIS GOTTHILF, a British zoölogist; born at Esslingen, Würtemberg, Oct. 3, 1830; educated at the universities of Tübingen, Berlin and Bonn; entered the service of the trustees of the British Museum in 1858, and was appointed keeper of the department of zoölogy in 1875. In 1864 he founded the *Record of Zoölogical Literature*, and edited the magazine from then until 1870; also co-editor of the *Annals and Magazine of Natural History*. He has published *The Fishes of the Neckar* (1853); *The Reptiles of British India* (1864); *The Fishes of the South Seas* (1873-78); *Reports on the Shore Fishes, Deep Sea Fishes and Pelagic Fishes in the Voyage of H. M. S. Challenger* (1887-88). He contributed to the ENCYCLOPÆDIA BRITANNICA a number of articles, among them ICHTHYOLOGY and REPTILES.

GURNEY, SIR GOLDSWORTHY, a British chemist and inventor; born at Treator, Cornwall, England, Feb. 14, 1793. He was educated for the medical profession, but became interested in the study of practical chemistry. He claimed the invention of the oxyhydrogen blowpipe, of the lime, magnesium, bude and oil-vapor lights, of the tubular boiler and of the high-pressure steam-jet. His claims of originality, or at least of priority, in all of these inventions, except the last-named, have been contested. He was the first, however, to make practical application of the high-pressure steam-jet. He applied the device to the locomotive in 1830, with the result of raising its speed from 12 to 30 miles per hour; later used it to ventilate mines (although to-day ventilation by use of fans is more common) and to extinguish fires in them. In 1849, a fire that had been burning for twenty years in the Clackmannan mine was extinguished by means of it. He also applied it to the exhaustion and consumption of poisonous gases in the London sewers. In 1852 he was given charge of the lighting and ventilation of the Houses of Parliament, and was knighted in 1863. He died at Reeds, Cornwall, Feb. 28, 1875.

GURNEY, JOSEPH JOHN, a British philanthropist; born Aug. 2, 1788, near Norwich, England, of a Quaker family. He was educated at Oxford, though not formally a student at the university; in 1818 was ordained preacher in the Society of Friends. He was wealthy, and used his money to promote philanthropic movements, and was particularly interested in the prison reforms carried on by his sister, Elizabeth Fry (q. v., Vol. IX, pp. 804, 805). He was prominent in a movement to give a more evangelical character to the doctrines of the Friends (see QUAKERS, Vol. XX, p. 149). He published *Notes on Prison Discipline* (1819); *Observations on the Religious Peculiarities of the Society of Friends* (1824); *Portable Evidence of Christianity* (1832); *Sabbatical Verses* (1837); *A Winter in the West Indies*, letters to Henry Clay (1840); *Thoughts on Habit and Discipline* (1844). Died at Earlham, Jan. 4, 1847.

GUROWSKI, ADAM, COUNT, a Polish historian;

born at Kalisz, Poland, Sept. 10, 1805. Expelled from the gymnasia of Warsaw and Kalisz for participating in revolutionary demonstrations, he continued his studies at German universities. In 1825 he returned to Warsaw, assisted to organize and took part in the unsuccessful revolution of 1830, and at its close escaped to France. In 1835 he published *La Vérité sur la Russie*, which was favorably received by the Russian government, and he was recalled, and employed in the civil service. In 1841 he went to Heidelberg, and devoted himself to study; afterward lectured in the University of Bern, Switzerland, spent some time in Italy, and in 1849 went to the United States; was translator in the State Department at Washington from 1861 to 1863. Among his works published in the United States are *Russia as It Is* (1854); *The Turkish Question* (1854); *A Year of the War* (1855); *America and Europe* (1857); *Slavery in History* (1860); and *My Diary*, notes on the Civil War (2 vols., 1862-66). He died at Washington, District of Columbia, May 4, 1866.

GURTEEN, STEPHEN HUMPHREYS VILLIERS, an American clergyman and author; born June 9, 1840, near Canterbury, England; educated at Jesus College, Cambridge; ordained deacon in 1875; priest, 1876; for a time was professor of Latin at Hobart College, Geneva, New York, and held rectorships in Buffalo, New York; Toledo, Ohio; and Springfield, Illinois. He published *A Handbook of Charity Organization* (1882); *What is Charity Organization?* (1879; reprinted 1880, 1881 and 1882); *The Arthurian Epic* (1895).

GUTHRIE, a town of Logan County, eastern Oklahoma, capital of the territory and of the county, situated on the Cimarron River, and on the Atchison, Topeka and Santa Fé railroad. It has cotton-gins, saw, flour and planing mills, carriage and furniture factories. It is situated in a fine grazing country, which also produces grains, potatoes, broom-corn, timber, etc. In 1890 the population was 5,333; and 10,006 in 1900.

GUTHRIE, JAMES, an American statesman; born in Nelson County, Kentucky, Dec. 5, 1792. He was educated at Bardstown, Kentucky; studied law, and in 1820 commenced practice in Louisville. He was a member of the state legislature from 1827 to 1840, and was president of the convention that framed the present constitution of the state; was secretary of the United States Treasury in 1853-57, and United States Senator in 1865-68; died in Louisville, March 13, 1869.

GUTHRIE, SAMUEL, an American chemist and inventor; born at Brimfield, Massachusetts, in 1782. He was an original discoverer of chloroform, independent of other experimenters working at the same time in the same field, and by priority of publication of his results seems entitled to the honor of the discovery. The elder Silliman of Yale College tested his method in 1831, while the discoveries of Soubeiran and Dr. Liebig were published in 1832. Guthrie called the substance a spirituous solution of chloric

ether, and it was not until 1834 that Dumas ascertained its composition and gave it its name, chloroform. He was also the inventor and first manufacturer of percussion-pills, and the punch-lock for exploding them, which superseded the old flint-lock. He was severely injured by an explosion while experimenting in this line. Died at Sackett's Harbor, N. Y., Oct. 19, 1848.

GUTHRIE, THOMAS ANSTEY, an English author, who writes under the name "F. Anstey"; born at Kensington, Aug. 8, 1856; educated at Trinity Hall, Cambridge, and called to the bar in 1880; wrote *Vice Versa* (1882); *The Giant's Robe* (1883); *The Tinted Venus* (1885); *A Fallen Idol* (1886); *Voces Populi* (reprinted from *Punch*, 1889); *Lyre and Lancet* (1896); *Puppets at Large* (1897); *Paleface and Redskin* (1898); *Love Among the Lions* (1898).

GUTHRIE CENTER, a village and the capital of Guthrie County, Iowa, on the South Racoon River, and the Chicago, Rock Island and Pacific railroad, 47 miles W. of Des Moines. It is the trading and shipping center of a large stock-raising and farming district, and has manufactories of plows, iron-work for bridge construction, novelties, bricks and flour. Population 1900, 1,193.

GUTTA ROSEA, a disease of the sebaceous glands of the nose and face. See *Acne Rosacea*, under SKIN DISEASES, Vol. XXII, p. 121.

GUTTIFERÆ OR CLUSIACEÆ, a family of dicotyledonous plants, consisting of trees and shrubs, natives of tropical countries, generally secreting an acrid, yellow, resinous juice. The leaves are opposite, destitute of stipules, leathery and entire. It contains numerous species, the greater part of them South American. The resinous secretions of some are valuable (as gamboge, from the East Indian *Garcinia morella*), and a few species afford valuable timber. The flowers of some are very fragrant; those of *Messua ferrea* are found, in a dried state, in every bazaar in India, and used as a perfume. The fruit of some is very highly esteemed, as those of *Garcinia mangostana* (*mangosteen*) of southeastern Asia, and *Mammea Americana* of the West Indies.

GUTTURALS, same as GLOTTIDS. See SPEECH-SOUNDS, Vol. XXII, p. 382.

GUYON, RICHARD DEBANFRE, a Hungarian general and patriot; born near Bath, England, March, 1813; entered the Austrian army in 1831; married the Countess Splényi, daughter of the Hungarian field-marshal, in 1838, and retired from the service. When the Hungarian revolution of 1848 broke out, Guyon offered his services to the national party; was made brigadier-general under Görgei, and took part in the battle of Veszce; followed Görgei on his march to Buda, and upon the surrender of that general, Aug. 13, 1849, took refuge in Turkey with other revolutionists. He entered the service of the Sultan under the name Kourschid Pasha, and was given command at Damascus. During the Crimean War he was engaged in raising troops in Asia Minor. Died in Constantinople, Oct. 12, 1856.

GUYOT, ARNOLD HENRY, a Swiss-American geographer; born in Switzerland, Sept. 28, 1807.

He took the degree of Ph.D. at Berlin in 1835; was the colleague of Agassiz at Neuchâtel in 1839-48, and in the latter year accompanied him to America. He delivered a course of lectures at Lowell Institute, which were translated and published as *Earth and Man*, in 1849; in 1854 was appointed professor of physical geography and geology at Princeton, which position he occupied until his death, being for some time senior professor. He had the management of the meteorological department of the Smithsonian Institution, where he delivered several courses of lectures, and in connection with which he published *Meteorological and Physical Tables* (revised ed., 1884). His other works include *A Treatise on Physical Geography* (1873); *Creation; or, The Biblical Cosmogony in the Light of Modern Science* (1884). He died at Princeton, New Jersey, Feb. 8, 1884.

GUY'S HOSPITAL, London, England, was founded by Thomas Guy (see GUY, THOMAS, Vol. XI, p. 341), who leased from the governors of St. Thomas's Hospital, a large piece of ground in Southwark, London, for a term of 999 years, at a ground-rent of \$150 a year. The hospital admitted its first patient in 1725, a few days after the death of its founder. In 1829 a Mr. Hunt bequeathed to the hospital \$950,000, and additional bequests to the amount of \$50,000 have since been received. There was at first room for about 400 patients; now, 700 can be accommodated. The yearly average of patients is over 5,000; the out-patients relieved may number above 80,000. The annual income is about \$122,500. Students enter the hospital for study, attending clinical practice, lectures, etc., and paying annual fees. A library and valuable museums are attached to the hospital. New wards, with tall towers for ventilation, were built in 1852, and a chemical laboratory in 1872. A dental school for complete instruction in dental surgery and mechanics, and a residential college for the accommodation of 50 students and the junior medical staff, have recently been added. In the chapel is a fine marble statue of Guy, by Bacon, which cost \$5,000. Sir Astley Cooper, the eminent surgeon, is buried in the chapel.

GUZEL-HISSAR. See AIDIX, Vol. I, p. 425.

GUZMAN-BLANCO, ANTONIO, a Venezuelan statesman; born in Caracas, Venezuela, Feb. 29, 1829. He studied law, and in 1859 joined a revolt led by General Juan Falcon, which, in 1863, resulted in the election of the latter to the Presidency and of Guzman-Blanco to the Vice-Presidency. Falcon was deposed in 1868 and Guzman-Blanco headed a revolution to reinstate him, which was successful. Falcon having died, Guzman-Blanco became President in 1870, and for 12 years kept himself in office, during which time unwonted peace and prosperity were maintained. He retired from the Presidency in 1882, and at the elections of 1883, one of his friends, General Joaquin Crespo, was elected, and he became ambassador to France. In 1886 he was re-elected to the Presidency, but in 1888 he was succeeded

by a political rival, Dr. Rojas Paul, and since then has lived in retirement.

GWIN, WILLIAM MCKENDREE, an American public man; born in Sumner County, Tennessee, Oct. 9, 1805. He studied medicine at Transylvania University, and removed to Clinton, Mississippi. He was appointed United States marshal for the district of Mississippi in 1833; in 1840 was elected to Congress. In 1849 he removed to California, where he took an active part in the formation of a state government. He was elected United States Senator for the long term; was re-elected, and served till March 3, 1861, securing for his state the location of the mint and navy-yard at San Francisco, and a survey of the Pacific coast. When the Civil War broke out he tried to induce California to join the Southern Confederacy, and was imprisoned for disloyalty. In 1863 he went to Paris, and, becoming interested in a scheme to colonize Sonora, Mexico, with Southerners, under the auspices of Maximilian's government, spent the two following years in an unsuccessful attempt to carry out his plan. He afterward returned to his home in California, and continued to take an active part in politics. He died in New York City, Sept. 3, 1885.

GWINNETT, BUTTON, a signer of the Declaration of Independence; born in England about 1732. He was for a time a merchant in Bristol, England; emigrated to Charleston, South Carolina, in 1770, and two years later purchased a plantation on St. Catherine's Island, Georgia, and engaged in agriculture; was elected to the general Congress in 1776, and signed the Declaration of Independence. He was re-elected for the ensuing year, and chosen president of the provincial council of his state. His death, May 27, 1777, resulted from a duel fought May 15, 1777, with General McIntosh, whom he had refused to appoint commander on a planned invasion of Florida.

GWYNN, NELL, mistress of Charles II of England; born about 1650, and brought up in the slums of London. As a child she earned her living by selling fruit on the streets and singing and dancing in tavern bar-rooms. Later she went upon the stage and took boys' parts in the licentious plays of those times. She was first the mistress of Charles Sackville, who, in 1669, gave her to Charles II. Two years later he appointed her lady of the privy chamber to Queen Catherine, giving her the name Madam Ellen. She was pretty, generous and witty, and won completely the affections of the king, who, on his deathbed, begged those around him not to forget his "poor Nell." She assisted many of her old friends with money and influence, and is said to have first proposed the Chelsea Hospital for soldiers and sailors, and to have secretly supported the Protestant cause at court. She bore two sons to the king. One died early, but the other was made Duke of St. Albans. After the death of King Charles she retired from court. She died about 1690, and her funeral sermon was preached by Dr. Tenison, afterward Archbishop of Canterbury. In his *Story of Nell Gwynn*

(1852), Peter Cunningham has related the history of her life.

GYE, MADAME. See ALBANI, MADAME, in these Supplements.

GYLDEN, JOHN AUGUSTUS HUGO, a Finnish astronomer; born at Helsingfors, Finland, May 29, 1841; studied at the University of Helsingfors, and was appointed astronomer at the Pulkowa Observatory; in 1871 was given the direction of the observatory in Stockholm; in 1884, of that in Göttingen. He published *Researches on the Constitution of the Atmosphere* (1866-68); *Studies on the Theory of Perturbations* (1871); and *Principles of Astronomy Shown in Connection with their Historic Development* (1877). Died at Stockholm, Nov. 9, 1896.

GYLIPPUS, a Spartan general; son of Cleandridas, and a Helot mother. He was sent, in 414 B.C., to take command of the Syracusans against the Athenians, who were besieging Syracuse. In the following year he totally destroyed the Athenian force, and took Demosthenes and Nicias prisoners. At the end of the Peloponnesian War he was sent to Sparta by Lysander to carry treasure, but proved unfaithful, and stole a portion of the money. The theft was discovered, and Gylippus fled the country.

GYMNETRUS, a genus of fishes of the ribbon-fish family. They are delicate, fragile fishes, living deep in the sea, and are rarely captured.

GYMNOCLADUS, a genus of trees of the family *Leguminosæ*. *G. Canadensis* is a North American tree, found both in Canada and over a great part of the United States, attaining a height of fifty to sixty feet, with upright branches and a rough bark. The leaves of young trees are very large, three feet long, bipinnate, and the leaflets remarkable for hanging edgewise. The flowers are white, in short spikes, the pods five to ten inches long by two broad. It is sometimes called the *Kentucky coffee-tree*, because the seeds were formerly roasted and ground as coffee in Kentucky. It grows well in Britain. The wood is used both by cabinet-makers and by carpenters. The pods, preserved like those of the tamarind, are said to be wholesome and slightly aperient.

GYMNODONT'S, a suborder of fishes remarkable for their grotesque shapes, which scarcely resemble those of ordinary fishes. The skin of the body is greatly distensible, especially in the ventral region. The scales are reduced to spines. The fish, variously known as swell-fish, globe-fish or puffer, is a good type of the group. The gigantic sunfish (*Mola*) of temperate seas is another well-known representative.

GYMNOSOMATA, an order of molluscs. See MOLLUSCA, Vol. XVI, p. 666.

GYMNOSPERMS. See VEGETABLE KINGDOM, Vol. XXIV, p. 131.

GYMNOTIDÆ. See ICHTHYOLOGY, Vol. XII, p. 694; and EEL, ELECTRIC, Vol. VII, p. 694.

GYMPIE, a town of eastern Queensland, Australia, on the Mary River; the terminus of a railroad; lat. 26° 25' S., long. 153° E.; 90 miles north of Brisbane. In the vicinity are important gold-fields. Population 1891, 8,449.

GYNOPHYTE, a name applied to a gametophyte which produces only female reproductive organs, as distinguished from the *androphyte*, which bears male reproductive organs.

GYP, the pen-name of Madame la Comtesse Sibylle Gabrielle Marie Antoinette Martel de Janville. See MARTEL DE JANVILLE, in these Supplements.

GYPSIES. See GIPSIES, Vol. X, p. 611.

GYPSY-WORT (*Lycopus Europæus*), some-

times also called water horehound, a perennial plant of the family *Labiatae*. It is a tall, erect, branching plant, slightly hairy, with a creeping root-stock. It is found in Britain, on the Continent of Europe, in Russian and Central Asia and North America, and is regarded as a febrifuge and stringent. It dyes a permanent black. The bugle-weed of North America (*L. virginicus*) has more powerfully astringent properties.

GYRFALCON. See FALCON, Vol. IX, p. 3.

# H

## HABBERTON—HACKETT

**HABBERTON, JOHN**, an American journalist and author; born in Brooklyn, New York, Feb. 24, 1842, receiving an education in the public schools of Illinois, whither his family had moved. From 1859 until he entered the army in 1862 he was connected with the publishing house of Harper Brothers; literary editor of the *Christian Union* from 1873 to 1876; since, one of the literary critics on the staff of the *New York Herald*. His first work was a series of sketches of Western life, followed by a volume of *Selections from the Spectator* (1876); in the same year appeared *Helen's Babies*, a humorous sketch without much literary pretense, of which nearly a quarter of a million copies have been sold in the United States; he has since written *The Barton Experiment* (1876); *The Jericho Road* (1877); *Other People's Children* (1877); *The Scripture Club of Valley Rest* (1877); *Some Folks* (1877); *The Crew of the Sam Weller* (1878); *Little Guzzy* (1878); *The Worst Boy in Town* (1879); *Just One Day* (1880); *Who Was Paul Grayson?* (1880); *Bowsham Puzzle* (1884); *George Washington* (1884); and *Couldn't Say No* (1890). His only play, *Deacon Crankett*, had a long and successful run on the stage.

**HABEAS CORPUS**, a writ or command issued by a court or officer of competent jurisdiction, directed to a person who is detaining another, requiring him to produce the person detained, at a time and place named in the writ, and show his reasons for such detention. The object of this writ is to obtain release from illegal restraint, and the summary nature of the proceedings under it makes the writ an exceedingly useful remedy. The Constitution of the United States provides that the privilege of the writ of *habeas corpus* shall not be suspended unless when, in cases of rebellion or invasion, the public safety may require it. Similar provisions are found in many of the state constitutions. This exception provided in the Federal Constitution is founded upon the fact that during the existence of a rebellion or invasion, the safety of the republic may require the imprisonment of those who may be suspected of crime against the government, while, if the privilege of the writ of *habeas corpus* were extended, sufficient proof might not be at hand to hold such prisoners. The exception is based rather upon public policy than justice, and is justified by the right of the government to adopt extreme measures to suppress insurrection or repel invasions. The supreme court of the United States has decided that the power to suspend the privilege of the writ of *habeas corpus* exists only in the Federal Government. Congress in 1863 authorized the President to suspend the privileges of the writ in any portion of the United States where he might deem it necessary during the continuance of the

Rebellion. By act of Congress, the jurisdiction of the Federal courts under the writ of *habeas corpus* has been fully established, but the practice is governed by the rules of common law. The legislatures of the various states have determined what officers and courts of the state shall have jurisdiction of the writ, and to a considerable extent have prescribed the practice to be followed. See also **HABEAS CORPUS**, Vol. XI, p. 358.

**HABITS**. See **INSTINCT**, Vol. XIII, pp. 157-159.

**HACKEL OR HITCHEL**, a comb instrument for rippling flax; see **FLAX**, Vol. IX, p. 294.

**HACKENSACK**, a town and the capital of Bergen County, northeastern New Jersey; located on the Hackensack River, 13 miles north of the Battery, New York, and on the New Jersey and New York and the New York, Susquehanna and Western railroads. It is lighted with electricity and gas, and has a city water-supply; manufactures silk, jewelry, bricks; has a good trade, and is quite a residence town for business men of New York. Population 1890, 6,004; 1900, 9,443.

**HACKER, ARTHUR**, an English painter; born in London; educated at St. John's College, London, and Paris; entered the Royal Academy Schools, and later became a pupil of Bonnat, in Paris. His first picture was exhibited in 1878. He devoted himself to genre pictures; among them are *The Daughter's Legacy* (Paris Salon, 1881) and *The Relics of the Brave* (1882). He then traveled through Spain and Morocco in 1881 and devoted himself to classical and religious subjects. His recent works are *Pelagia and Philammon*; *Persephone*; *Vae Victis*; *Christ and the Magdalen*. He was elected an associate of the Royal Academy (1894).

**HACKETT, HORATIO BALCH**, an American classical scholar; born in Salisbury, Mass., Dec. 27, 1808; graduated at Amherst in 1830, and studied theology at Andover and in Germany. He became a tutor at Amherst, professor of ancient languages at Brown University, and in 1839 professor of Biblical literature in Newton Theological Institute, which last position he held until 1869. He visited Egypt and Palestine, spending 1858-59 in Athens, to become familiar with modern Greek. In 1870 he became professor of New Testament Greek in Rochester Theological Seminary. He was one of the American revisers of the Bible, and the author of several Hebrew text-books; a *Commentary on the Acts* (1851); *Illustrations of Scripture* (1855); and *Memorials of Christian Men in the War*. He assisted Dr. Ezra Abbott in editing the enlarged American edition of *Smith's Dictionary of the Bible*. He died in Rochester, New York, Nov. 2, 1875.

**HACKETT, JAMES HENRY**, an American actor; born in New York City, March 15, 1800; studied a short time at Columbia College; failed in business life; his wife, an English actress, urged him to adopt the theatrical profession; began with clever imitations in 1826; spent one year on the London stage; returned to America and succeeded well in low comedy; played a realistic Rip Van Winkle that lacked neither force nor verity; was not so happy in his Shakespearian characters, his Hamlet especially falling flat. He was a man of literary attainments, and the associate of Irving, Cooper and other prominent authors of his day; as a theater manager he made money, especially in his Italian opera venture with Mario and Madame Grisi. He died in Jamaica, Long Island, Dec. 28, 1871.

**HACKETTSTOWN**, a town of Warren County, northwestern New Jersey, situated 14 miles east of Belvidere, on the Musconetcong River, and the Delaware, Lackawanna and Western railroad. It contains the Newark Methodist Episcopal Conference Seminary, a car manufactory, foundries, several carriage manufactories, silk factories, and one of agricultural tools. Its surroundings are beautiful; it is inclosed on three sides by mountains, at the head of the beautiful Musconetcong Valley. It has a water supply taken from mountain springs. Population 1900, 2,474.

**HACKLÄNDER, FRIEDRICH WILHELM VON**, a German novelist and playwright; born at Burtscheid, near Aix-la-Chapelle, Nov. 1, 1816. He commenced his literary career with the publication of *Bilder aus dem Soldatenleben* (1841), and three years later followed up his success with *Das Soldatenleben im Frieden* (9th ed., 1883). He accompanied Baron von Taubenheim on his travels to the East, after which he published *Daguerreotypen aufgenommen auf einer Reise in den Orient*, and in 1843 was appointed private secretary to the Crown-Prince of Würtemberg, with whom he traveled in Italy, France and Russia. Later the King of Würtemberg gave him a pension on the civil list, and made him a baron; in March, 1849, he went to Italy, and was present with Radetzky's army during the campaign in Piedmont. From 1859 he lived chiefly in Stuttgart. The best of his longer novels are *Handel und Wandel* (1850); *Eugen Stillfried* (1852); and *Namenlose Geschichten* (1851). His best comedies are *Der Geheime Agent* (1850), which has been performed throughout Germany, and translated into several European languages, and *Magnetische Kuren* (1851). He was the founder (with Zoller) of the most successful German illustrated weekly, *Ueber Land und Meer*, and a number of his later stories appeared therein as serials, the last one *Verbotene Frucht*. A year after his death appeared a short autobiography, *Roman Meines Lebens*. He ranks among the best German fiction-writers of the century. He died in Munich, July 6, 1877.

**HACKMATACK**. See LARCH, Vol. XIV, p. 312.

**HA-DANI**, or the DANITE. See ELDAD BEN MALCHI, Vol. VII, p. 827.

**HADDAM**, a town and one of the capitals of Middlesex County, central Connecticut, on the west bank of the Connecticut River, 29 miles above its mouth, and on the New York, New Haven and Hartford railroad. It has large granite quarries. Population 1890, 2,095; 1900, 2,015.

**HADDONFIELD**, a borough of Camden County, southern New Jersey, on two branches of the Camden and Atlantic railroad, 5 miles S. E. of Camden. Industry, farming. Population 1890, 2,502; 1900, 2,776.

**HADEN, SIR FRANCIS SEYMOUR**, an English surgeon and etcher; born in London, Sept. 16, 1818; educated at University College, London, and at the Paris School of Medicine; successively member (1842) and fellow (1857) of the Royal College of Surgeons; gave much time and influence to the proper disposal of the dead; combated cremation, but secured the adoption of hygienic measures in burial-grounds. His famous paper, entitled *The Relative Claims of Etching and Engraving to rank as Fine Arts, and to be represented as such in the Royal Academy*, resulted in the organization of a society of etchers, of which he was naturally the first president. His own contributions to the art were considerable and of high merit, counting up into the hundreds; they are catalogued in Sir W. R. Drake's book, *The Etched Work of Francis Seymour Haden*. He was knighted in 1894.

**HADING, JANE**, the stage-name of JEANE TRÉFOURET HADING, a French actress; born at Marseilles, France, Nov. 25, 1859. At the age of three she played Blanche de Caylus in *Le Bossu*, her father at the same time playing the leading character. Educated at Marseilles Conservatoire, she played several light-comedy parts when but fourteen years old. She sang also in operetta, and in 1879 was the heroine in *Héloïse and Abelard*; in 1883, returning to comedy, she played Paulette in *Autour de Mariage*; finally she began her great career as an emotional actress in Claire de Beaulieu of *Le Maître des Forges*. In 1889 she made a successful tour of the United States, accompanying M. Coquelin, of the Comédie Française.

**HADJ OR HAJJ**. See MECCA, Vol. XV, pp. 674, 675.

**HADLEY, ARTHUR TWining**, an American economist, son of JAMES HADLEY (mentioned below); born April 23, 1856; graduated at Yale College (1876); studied political science in Berlin; tutor at Yale (1879-83); statistical commissioner of Connecticut (1885-87); professor of political science in Yale (1886); president of Yale (1899); made special studies in railway transportation; wrote on *Foreign and Continental Roads* in the article RAILWAY of this ENCYCLOPEDIA (Vol. XX, pp. 250-52); and also *Railroad Transportation: Its History and Its Laws* (1885); and a history of Yale in *Four American Universities* (1895).

**HADLEY, JAMES**, an American philologist; born at Fairfield, Herkimer County, New York, March 30, 1821; a cripple from boyhood, he graduated at Yale College (1842); tutor there (1845-48); full professor of Greek (1851-72). Besides Greek, he was thoroughly versed in Arabic, Ar-



menian, Hebrew, Sanskrit, Irish, Gaelic, Welsh and the principal modern languages; was founder and president of the American Oriental Society from 1870 to 1872; member American Academy of Sciences; lectured frequently on civil law; published a *Greek Grammar* for schools and colleges (1860); *Elements of the Greek Language* (1869); posthumously, twelve lectures on law and twenty philological essays. He wrote the *Brief History of the English Language* contained in the 1864 edition of Webster's Dictionary. He died Nov. 14, 1872.

HADLEY, JOHN, an English mathematician; an intimate friend of Newton, from whom, it is said, he borrowed the idea of his sextant; Godfrey was another claimant for this invention, and divided with Hadley the prize granted by the Royal Society. In 1717 Hadley was made a member of the Royal Society. He died Feb. 15, 1744. See SEXTANT, Vol. XXI, pp. 724, 725.

HAECKEL, ERNST HEINRICH, a German evolutionist; born at Potsdam, Feb. 16, 1834.

He studied natural science and medicine with Virchow in Würzburg, and with Johann Müller in Berlin; soon became distinguished for his originality in zoological studies. After working for a time at Naples and Messina, he became a private tutor in the University of Jena in 1861, a professor extraordinary in 1862, and an ordinary professor

of zoölogy in 1865, a chair especially created for him. He visited Darwin and then traveled extensively in Spain, northern Africa and Madeira; in 1875, on a steamer supplied to him by the Khedive he examined the coral reefs of the Red Sea. Haeckel devoted his life to applying the doctrine of evolution, and brought forward many interesting facts in support of the theory. The most important of his numerous systematic works are *Die Radiolarien* (1862); *Ueber die Entstehung und Stammbaum der Menschengattung (The Origin and Development of the Human Race)* (1870); *Das Leben in der Meerestiefen (Life in the Sea-Depths)* (1870); *Die Kalkschwämme (The Calcareous Sponges)* (1872); *Natürliche Schöpfungsgeschichte (Natural History of Creation)* (6th ed. 1875); *Anthropogenie (Origin of Man)* (3d ed. 1877); *System der Medusen* (1879); contributions to the *Challenger Report on Deep-Sea Medusæ* (1882); *Indische Reisebriefe (Letters from India)* (1882); *Darwin, Gøthe und Lamarek* (1882); *Ursprung und Entwicklung der Thierischen Gewebe (Origin and Development of Animal Tissues)* (1884); *Siphonophora* (1888); *Radiolaria* (1887). Haeckel's *Generelle Morphologie* (1866) attracted scientific attention for its proposals to draw lines between which distinction of animal and vegetable ceased, and to call the group *Protista*. In this work he also fortified with new researches the doctrine that each organism re-

peats its phylogenetic history as it develops into maturity. *Die Kalkschwämme* showed the arbitrary character of the specific classification of sponges, for he constructed from the *Ascetta primordialis* a typical ancestral sponge, from which he derived seven species, embracing the whole group. This work was a direct reinforcement of Darwin's doctrine of the variation of species. Haeckel did much for histology and phylogeny by his *Gastræa Theorie* (1874). He proposed to divide the animal kingdom into *Protozoa* or *Metazoa*, and *gastrozoa*. The latter class began with animals which, at some ancestral stage, developed from two cell-layers arranged in a sack-like way, suggesting a stomach. This stage is known as that of the *Gastrula*. All organisms that have passed through that stage in their development he held to have been derived from a *Gastræa*, a theoretical form. This suggestion was very fruitful in directing research, and Haeckel won the renown of being one of the most indefatigable champions of the unity of evolution by differentiation of species.

HÆHNEL, ERNST JULIUS, a German sculptor; born at Dresden March 9, 1811. He studied architecture, but in 1830 he went to Munich and devoted himself to sculpture under Rietschel and Schwanthaler. Being recalled to his native city in 1838, he executed some remarkable bas-reliefs for the new theater there, also statues of Sophocles, Aristophanes, Molière and Shakespeare. Among his other works are a statue of Beethoven (1845) now in Bonn; a statue of Charles V, for the University of Prague; a statue of Weber, the composer, for the city of Dresden, and for the new museum of Dresden, six statues: Alexander the Great, Lysippus, Michel Angelo, Dante, Raphael, and Peter von Cornelius. After 1858 he made statues of the four evangelists for the cathedral tower in Dresden; an equestrian statue of Prince Schwarzenberg for Vienna; a bronze statue of Leibnitz for Leipsic, and many other statues for his native city. Hæhnel became a member of the academy at Dresden in 1842, and a professor in 1848.

HÆMATITE OR HEMATITE, ores of iron. See MINERALOGY, Vol. XVI, p. 385.

HÆMATOXYLIN, the coloring principle of logwood. See LOGWOOD, Vol. XIV, p. 805.

HÆMATOZOA (Gr. *haima*, "blood," and *zōon*, an "animal"), parasites occurring in the blood. See PARASITISM, Vol. XVIII, pp. 258-271.

HÆMOCYTOMETER, an apparatus for assisting in the enumeration of the red and white corpuscles in the blood. It consists of microscopic slides, cross-ruled with exceeding fineness, so that the squares produced may contain so few corpuscles that it is possible to count them. The proportion of red to white corpuscles in the human blood is about five hundred to one, in a state of health. By the hæmocytometer the physician may determine whether the proportion in a patient's blood is normal. By diluting a few drops of blood with acetic acid the white and red corpuscles are separated. The white portion of



ERNST H. HAECKEL.

the blood may then be dropped from a tube on one of the finely-ruled microscopic slides. Being powerfully magnified, the number of corpuscles in sixteen squares may be counted, and the remainder computed. The blood containing the red corpuscles is treated in the same manner, the result being a close approximation of the proportions of the corpuscles in the blood of the patient. The blood used is best drawn from the lobe of the ear, great care being taken to procure it entirely clean. The slides are of ground glass, and are divided into 256 squares, each of which is subdivided again into 16 squares. Cases of internal tumor, previously unsuspected, have been diagnosed accurately by the aid of the hæmocytometer, and it is also valuable in noting the effect of certain remedies given to a patient.

C. H. COCHRANE.

HÆMODORACEÆ, an order of monocotyledons, consisting of herbaceous plants with fibrous roots and sword-shaped leaves, differing from *Iridaceæ* in habit and in having the stamens six in number, or, if only three, opposite to the petals. There are about 120 known species, and they occur in all parts of the world except Europe.

HÆMOGLOBIN, the coloring-matter of the red corpuscles of the blood. See ANATOMY, Vol. I, pp. 845-6; and RESPIRATION, Vol. XX, pp. 483, 484.

HAGBERG, JAKOB TEODOR, a Swedish littérateur and philologist; born in Stockholm, 1825; graduated in 1848 from the Upsala University; in 1868 was made professor of modern languages in his *alma mater*; published an *Italian Grammar* (1863); *Dramas by Calderon* (1870); and *Petrarch's Sonnets* (1874); wrote several original dramas; also exhaustive critical studies of Molière, Rabelais and *Provençal Literature in the XIXth Century*.

HAGDON OR HAGDEN, a fish, the *Puffinus anglorum*. See SHEARWATER, Vol. XXI, p. 781.

HAGEN, HERMANN AUGUST, a German-American entomologist; born in Königsberg, Prussia, May 30, 1817; in 1840 he received a medical degree from the University at Königsberg, and later studied in Paris, Berlin and Vienna. He devoted much attention to entomology, and in 1834 published a paper on *Prussian Odontata*. For some time from 1843 he practiced medicine at Königsberg as first assistant at the surgical hospital. From 1863 to 1867 he was vice-president of the city council. In 1870, thanks to the influence of Louis Agassiz, to whom his great learning was known, he was made professor of entomology at Harvard University. Wrote upwards of four hundred articles on scientific subjects, several of the most important being included in his *Bibliotheca Entomologica* (Leipsic, 1862). He died in Cambridge, Massachusetts, Nov. 9, 1893.

HAGERSTOWN, a city and the capital of Washington County, western Maryland. It lies in the fertile Cumberland valley, 86 miles W. of Baltimore. It is the terminus of the Shenandoah Valley railroad and of a branch of the Baltimore

and Ohio system. The Cumberland Valley railroad and the Western Maryland railroad run through the town. Hagerstown has a fine courthouse, a jail, and an academy of music; also a free library, public water-works, banks, hotels, churches, seminaries and public schools. Several newspapers are published here. This town is a local center of social refinement, the population being mostly of American birth, many of German descent. The chief manufactures are furniture, wheels, doors, sashes, castings, farm tools, brooms, cigars and fertilizers. It is an active trade center. Population 1890, 10,118; 1900, 13,591. See HAGERSTOWN, Vol. XI, p. 370.

HAGGADAH OR AGADAH. See MIDRASH, Vol. XVI, pp. 285, 286.

HAGGARD, HENRY RIDER, an English novelist; born at Bradenham Hall, Norfolk, June 22, 1856; educated at Ipswich Grammar School; accompanied Sir Henry Bulwer to Natal as his private secretary in 1875, and subsequently served in a similar capacity under Sir Theophilus Shepstone, commissioner to the Transvaal, until he was appointed Master of the High Court of the Transvaal. On his return to England, in 1879, he retired from official life and settled down to a literary career. He published *Cetewayo and His White Neighbors* (1882); his first novel, *Dawn* (1884); and *The Witch's Head* (1885). The publication of *King Solomon's Mines* (1886) won for him great popularity, which was increased by the appearance of *She* in 1887. *Jess*, *Allan Quatermain*, *Maiwa's Revenge*, *Mr. Meeson's Will*, *Cleopatra*, *Allan's Wife*, and *Eric Brighteyes*, are among Mr. Haggard's later writings. In 1895 he published a novel, *Joan Haste*, which was not equal to his African fancies, weird and extravagant though they were. In 1896 he returned to the scene of his former successes with *The Heart of the World*.



HENRY RIDER HAGGARD.

HAGIOGRAPHIA. See CANON, Vol. V, p. 2.

HAGUE, ARNOLD, an American geologist; born in Boston, Dec. 3, 1840; graduated at the scientific school of Yale in 1863; for three years studied at Göttingen, Heidelberg and Freiberg; in 1867 was appointed assistant on the United States geological exploration of the 40th parallel under Clarence King. From 1867 to 1868 he was in California and Nevada studying the various processes in use in the leading gold and silver mines; contributed a number of papers to the United States government reports. In 1877 he became government geologist of Guatemala. In 1878 the Chinese government employed him to examine its mines of precious metals in northern China. In 1879 he returned to the United States, and became one of the geologists of the government survey. In 1883 he was appointed geologist of the Yellowstone Park division. In 1885 he became

a member of the National Academy of Sciences. Wrote a number of works on volcanic formations, also *Nevada, with Notes on the Geology of the District* (1885).

**HAGUE PEACE CONFERENCE.** This conference was called in Aug. 1898, at the instance of Russia, to meet at The Hague, in the Netherlands, and consider proposals, originating with the Tsar, for national disarmament and the maintenance of peace. The conference, which assembled in May 1899, was represented by twenty-six states of the world. Baron de Stael, of Russia, being president. The American delegates were And. D. White, ambassador to Germany; Stanford Newel, U. S. minister to the Netherlands; Capt. Wm. Crozier, of the Ordnance Dept. of the U. S. army; Capt. A. T. Mahan, of the U. S. navy (retired); Pres. Seth Low, of Columbia University; and F. W. Holls, of N. Y., secretary of the delegation. As the sessions were held in secret, it has been difficult to learn just what the conference achieved as a whole; the results are understood to have been meagre and disappointing. Russia's proposals for arbitration, having a compulsory and binding rider attached, were not palatable to the conference. The chief gains at the meeting were those credited to England and the United States, the arbitration scheme offered by the two latter nations, being voluntary in its exactions, were more favorably considered. Reduction of armaments, favored by Russia, was brought up by delegates of the Tsar, but, as militarism was in the ascendant, the proposals did not meet with the approval of the representatives of the conferring Powers. The proposal to place a limit, for a period of years, on the annual budget appropriations for naval and military purposes, and to exact pledges that the military forces of the nations shall not be added to save for service in the colonies and outlying possessions of the subscribing Powers, was more favorably received. But the practical outcome of the conference was on the whole little, beyond attesting the amiable and peace-loving character of the Tsar; though the moral gains of the meeting made it notable and indirectly were not without result.

**HA-HA BAY.** See **QUEBEC**, Vol. XX, p. 165 and **GRAND BAY**, in these Supplements.

**HAIDARABAD**, district and city of Sind, India. See **HYDERABAD**, Vol. XII, pp. 429, 430.

**HAIDUK.** See **HAJDUK**, Vol. XI, p. 377.

**HAIL COLUMBIA.** See **HOPKINSON, JOSEPH**, *post*, pp. 1612-13.

**HAILEY**, a town, the capital of Blaine Co., Idaho, 96 miles E. of Boise City, on Wood River and the Union Pacific railroad; gold, silver, copper, and lead mines are near, stone is quarried, and bricks and lime are manufactured. The town exports ores, grains, hides, and wool; is supplied with city water, electricity, and a telephone system; the streets and gardens are watered by irrigation ditches. A mile and a half to the west are the Hailey Hot Springs, of water containing sulphate of soda, iron, and magnesia, at 150° F. These springs and their hot baths make Hailey an important health resort. Pop., 1897, 1073; 1900,

(12th census), Hailey precinct, 1,240.

**HAILSTORM.** See **METEOROLOGY**, Vol. XVI, p. 132.

**HAIMURA**, a large voracious fish of the genus *Erythrinus*, found in the fresh waters of northern South America. The inhabitants use great numbers as food. Men have been attacked and seriously lacerated by the sharp teeth of the fish.

**HAIR-GRASS**, the common name of species of *Deschampsia*, a genus of grasses having delicately paniced inflorescences, bearing 2-flowered spikelets, the flowering glumes with a fine dorsal awn below the middle. The species are natives of temperate and cold climates. The tufted hair-grass, or tufted grass (*D. caespitosa*), common in better pastures and meadows, is a beautiful grass when in flower. The other common species of the United States are *D. flexuosa*, *D. danthonioides*, and *D. latifolia*. The genus formerly was considered a subgenus of *Aira*, under which generic name the above-mentioned species all appeared.

**HAITI** (République d'Haïti), the western portion, near to Cuba, of the island of Santo Domingo. See under **HAYTI**.

**HALACHA.** See **HERMENEUTICS**, Vol. XI, p. 742.

**HALCYONIDÆ.** See **KINGFISHER**, Vol. XIV, p. 82.

**HALDEMAN, SAMUEL STEHMAN**, an American naturalist and philologist; born at Locust Grove, Pennsylvania, Aug. 12, 1812; partly educated at Dickinson College; assistant state geologist of New Jersey, 1836; assisted in the geological survey of Pennsylvania, 1842, and during that time prepared five annual reports. In 1842-43 he delivered lectures on zoölogy at the Franklin Institute in Philadelphia, and in 1851 was made professor of natural sciences in the University of Pennsylvania. In 1855 he accepted a similar professorship in Delaware College. From 1869 to his death he was professor of comparative philology in the University of Pennsylvania. He gave much time to the study of the human voice, discovering thus more than fifty varieties of human speech; was an earnest advocate of spelling-reform, and the founder and president of the American Philological Society. His contributions to scientific literature include over 200 titles, covering entomology, conchology, geology, chemistry, paleontology and philology; among them are found *Fresh-Water Univalve Mollusca of the United States* (1840); *Zoological Contributions* (1842); *Elements of Latin Pronunciation* (1851); *Tours of a Chess Knight* (1865); *Affixes in Their Origin and Application* (1865); *Rhymes of the Poets* (1868); *Pennsylvania Dutch* (1872); *Outlines of Etymology* (1877); and *Word-Building* (1881). He died at Chickies, Pennsylvania, Sept. 10, 1880.

**HALE, BENJAMIN**, an American educator; born in Newburyport, Massachusetts, Nov. 23, 1797; graduated with high honors from Bowdoin, 1818; studied theology at Andover, and in 1822 was licensed to preach as a Congregationalist; in 1823 became tutor in Bowdoin, and subsequently principal of the Gardiner Lyceum. From 1827

to 1835 he was professor of chemistry and mineralogy at Dartmouth. He joined the Protestant Episcopal Church, in which he took orders, and from 1836 to 1858 was president of Hobart College, Geneva, New York, resigning in the latter year on account of feeble health. He wrote *Introduction to the Mechanical Principles of Carpentry* (1827); *Scriptural Illustrations of the Liturgy* (1835); and *Education in Its Relations to a Free Government. His Life*, with selections from his works, published (1883) by Rev. Malcolm Douglass. He died at Newburyport, July 15, 1863.

HALE, EDWARD EVERETT, an American Unitarian clergyman and author; was born in Boston, Massachusetts, April 3, 1822. His mother was a sister of Edward Everett, and his father, Nathan, became proprietor of the Boston *Daily Advertiser*, on which the son served in many ways from office-boy to editorial management. Nathan bore the name of his uncle, the revolutionary patriot, and was also one of the founders of the *North*



EDWARD EVERETT HALE.

*American Review* and *The Christian Examiner*, periodicals that eventually passed to the editorial control of the son. Edward was graduated at Harvard in 1839, having prepared for college at the Boston Latin School, where he subsequently taught. At twenty years of age he began to preach, supplying pulpits as occasion offered. He had but two pastorates, the first of ten years from 1846 at Worcester, Massachusetts; the second from 1856 at the South Congregational Church, Roxbury, Boston. In 1879 he received a doctorate in theology from Harvard College.

Dr. Hale was indefatigable in literary work, and to him is due the establishment of a number of magazines. Besides editing the periodicals named, he revived the *New England Magazine*, and founded the *Old and New* in 1869, which was merged later in *Scribner's Monthly*, and *Lend a Hand* in 1885, a monthly devoted to charitable and sociological enterprises. Articles from his pen also found frequent introduction into periodical literature.

While engaged upon the *Daily Advertiser* Mr. Hale began extensive studies upon Spanish-American history, and in time became an accepted authority on such subjects. Some of his more important papers were published as contributions to antiquarian societies. He brought out an American edition of Dr. John Lingard's *History of England* (1853); and wrote *Stories of Discovery* (1882); a *Life of George Washington* (1888) from new sources; a *History of the United States* (1888) for Chautauqua circles; *Franklin in France* (1888) from original documents; and *The Story of Spain* (1886).

In philanthropic work Dr. Hale was full of suggestion. His *Ten Times One is Ten* (1870), show-

ing how a single life might accomplish beneficent ends, gave rise to organizations of young persons for doing good by individual influence, variously known as "Harry Wadsworth Clubs," "Lend-a-Hand Clubs" and the "Look Up Legion," precursors of the Christian Endeavor Societies. Many of his stories were designed to illustrate methods of social reform, as *In His Name* (1873), a tale of the Waldenses; *How they Lived in Hampton* (1888); *Mr. Tangier's Vacations* (1888); and *My Friend the Boss*.

But Dr. Hale is perhaps best known as the writer of short stories. *My Double and How He Undid Me* came out in the *Atlantic Monthly* in 1859, and attracted great attention; but its vogue was surpassed by *A Man Without a Country* (1861), a tale full of pathos, in which a young officer is punished for treason by never having his country named to him.

A complete enumeration of his more than two-score books is here out of the question. Among them the best known are *If, Yes and Perhaps* (1868); *The Ingham Papers* (1869); *Ups and Downs* (1873); *Philip Nolan's Friends* (1876); *A Family Flight over Egypt and Syria* (1882), in connection with his sister Susan; *About Home* (1884); *Through Mexico* (1886); *The Story of Massachusetts* (1891); *East and West* (1892), a novel; and many tales of travel or adventure.

HALE, EUGENE, a United States Senator; born in Turner, Maine, June 9, 1836; received a high-school education; was admitted to the bar in 1857; for nine successive years county attorney for Hancock County, Maine; a member of the state legislature in 1867, 1868 and 1880; and a member of Congress from 1869 to 1879. He was elected to the United States Senate as a Republican; took his seat March 4, 1881; was re-elected in 1887 and 1893. He repeatedly refused cabinet appointments, first from General Grant, later from President Hayes. His term of service will expire March 3, 1899.

HALE, HORATIO, American ethnologist (a son of SARAH J. HALE; q.v., *post*, p. 1508); born in Newport, N. H., May 3, 1817; graduated from Harvard, 1837; accompanied Captain Wilkes's expedition to the Antarctic regions; attracted to the study of anthropology, he traveled extensively for the purpose of making original observations and collecting documentary evidence; admitted to the Chicago bar, he practiced law at Clinton, Canada, without discontinuing his favorite studies; in 1886 he presided over the section of anthropology at the meeting of the American Society for the Advancement of Science, his address on *The Origin of Language and the Antiquity of Speaking Man* provoking much discussion. He gave much attention to the languages and customs of the American Indians. Among his other works are the seventh volume of the Wilkes Expedition Reports (1846); *The Iroquois Book of Rites* (1883); *Indian Migrations as Evidenced by Language* (1883); and *Report on the Blackfoot Tribes* (1885). Died at Clinton, Canada, Dec. 30, 1896.

HALE, NATHAN, an American soldier, spy, and hero; born in Coventry, Connecticut, June 6, 1755;

graduated at Yale in 1773; taught school in East Haddam, and later in New London, Connecticut. At the beginning of the Revolutionary War he enlisted as a volunteer, and became a lieutenant in Colonel Charles Webb's regiment. In January, 1776, he was made a captain and ordered to New York, where, with a few picked men, he captured at midnight a supply vessel lying under the guns of an English war vessel. He soon passed to the Connecticut Rangers of the Continental army, and on General Washington's call for a volunteer to enter the British lines and procure intelligence, Captain Hale responded, and, disguised as a loyalist schoolmaster, he visited all the British camps in New York and on Long Island. He obtained the needed information, but when about to return was arrested, tried by court-martial and condemned to be hanged before sunrise on the next morning. The execution took place in Colonel Henry Rutgers' orchard, near the junction of East Broadway and Market Street, New York City, Sept. 22, 1776. Captain Hale's last words were: "I only regret that I have but one life to lose for my country." Two monuments were erected to the memory of this patriot: one in the capitol at Hartford, Connecticut, and the other, by McMonnies, in City Hall Park, New York. His life and exploits are dealt with in *The Life of Captain Nathan Hale, the Martyr-Spy of the American Revolution*, by Isaac W. Stuart (1856); and Benson J. Lossing's *The Two Spies, Nathan Hale and John André* (1886).

HALE, NATHAN, an American journalist; the nephew of the patriot-martyr Nathan, and the father of Edward Everett; born in Westhampton, Massachusetts, Aug. 16, 1784; graduated at Williams College 1804; was admitted to the Boston bar in 1810, and in 1814 became an editor of the *Boston Weekly Messenger*. The same year he purchased the *Boston Daily Advertiser*, and continued as its chief editor until his death. He was a founder of the *North American Review* in 1815, and of the *Christian Examiner* in 1828, and in 1840 he edited and published the *Monthly Chronicle*. He was for nineteen years president of the Boston and Worcester railroad, the first company in New England to use steam-power, and in 1846 was chairman of the commission for building water-works for Boston. He was at various times a member of the legislature, and held important offices in various literary organizations. He published numerous plans and maps of his own design, also the *Journal of Debates and Proceedings in the Massachusetts Constitutional Convention* (1821). He died in Brookline, Massachusetts, Feb. 9, 1863.

HALE, SARAH JOSEPHA (BUELL), an American author; born in Newport, New Hampshire, Oct. 24, 1788. In 1822 she was left a widow with five small children, and found in her indefatigable literary work the means of living. From 1828 to 1837 she edited the *Boston Ladies' Magazine*, and when this periodical was united with *Godey's Lady's Book*, published in Philadelphia, she became editor of this magazine. In 1877 she retired from editorial work. Mrs. Hale was the author of *Woman's Record, or Sketches of all Dis-*

*tinguished Women from the Creation to the Present Day* (1853); *Northwood* (1827); *Sketches of American Character* (1830), and a number of other useful and entertaining works in prose and verse. Among her fugitive pieces *Mary's Lamb* is one of the most widely known. Her exertions in behalf of the Bunker Hill monument fund, her interest in seamen, in foreign missions, and in the higher education of women, were untiring and effective. For more than twenty years she advocated the keeping of Thanksgiving Day as a national festival, to be held on the same day throughout the country, as it has been observed since 1864, when President Lincoln adopted her suggestion. She died in Philadelphia, Pennsylvania, April 30, 1879.

HALES, JOHN, an English divine and critic; born at Bath, April 19, 1584. At the age of thirteen he entered Corpus Christi College Oxford, obtained a fellowship at Merton College in 1605, and in 1612 became professor of Greek in his university. In 1618 he went to The Hague as chaplain to the ambassador, Sir Dudley Carleton, for whom he made a report of the proceedings at the famous Synod of Dort. He was there converted to Arminianism, his amiable spirit being distressed by the disputatious rancor of the Gomarist party. Subsequently he was appointed to a canonry at Windsor. The Puritan supremacy deprived him of this office and reduced him to poverty. Hales was one of the oldest of what is now called the Broad Church school—a rare example of a profound student without pedantry, a ripe theologian with an altogether untheological clearness of mind and directness of phrase. Soon after his death was published the *Golden Remains of the Ever-memorable Mr. John Hales, of Eton College* (1659); in 1765 his *Complete Works* (in 3 volumes) were published in Glasgow. He died at Eton, May 19, 1656.

HALÉVY, JOSEPH, a French orientalist; born at Adrianople, Turkey, Dec. 15, 1827. He studied the Semitic languages, and afterward taught Hebrew in Adrianople and Bucharest. He went to Paris to complete his studies, and obtained letters of naturalization; and became widely known through his Hebrew poems. The *Alliance Israélite Universelle* commissioned him in 1868 to examine the condition of the Fallasha branch of the Jewish religion, in Abyssinia. His report attracted much attention. In 1869 the French government sent him to the southwestern part of Arabia, called Yemen (Arabia Felix of the Romans), to explore it archæologically. Here he deciphered 683 inscriptions, and on his return received the gold medal of the French Geographical Society and the Volney Prize of the Institute of France. He published several volumes on oriental antiquities and epigraphy. Among his notable books are *Critical Researches concerning the Origins of Babylonian Civilization* (1876); *Religious Documents concerning Assyria and Babylonia*; Assyrian text, translation and commentary (1882); *Critical and Historical Miscellany about Semitic People* (1885).

HALÉVY, LÉON, a French poet and dramatist, of Jewish extraction, and a brother of the famous composer, JACQUES FROMENTAL HALÉVY (q. v., Vol. XI, p. 382), born in Paris, in 1802; was educated at the Charlemagne Lyceum, where he became a proficient Greek scholar. Afterward he was a follower of Saint-Simon; assisted the latter in founding *Le Producteur*; issued the *Poésies Européennes*; wrote a *Résumé de l'Histoire des Juifs*; and in 1838 the *Histoire Résumé de la Littérature Française*; from 1831 to 1834 he was professor of French Literature at the Ecole Royale Polytechnique; from 1838 to 1853 he was employed in the bureau of historic monuments in the department of Public Instruction. In 1855 he published the *Fables Nouvelles*, and in 1861 finished *La Grèce Tragique*. Besides, he wrote numerous poems, novels, tales, and translations from ancient and modern languages—Horace and Shakespeare being among his best efforts. His dramatic works cover a wide field. They include the tragedies *Le Czar Demetrius*, and *Electra*, the comedy *Le Duel*, and many dramas. He died at St. Germain-en-Laye, Sept. 3, 1883.

HALÉVY, LUDOVIC, a French dramatist; born at Paris Jan. 1, 1834, and a son of Léon Halévy (q. v.); completed his studies at the Lycée Louis-le-Grand, in Paris; was attached to the Ministry of State, and later for three years Bureau-chief in the Ministry of the Colonies; in 1861 became one of the short-hand writers to the Corps Législatif. He first became known as one of the writers of the librettos to Offenbach's burlesques: *Orphée aux Enfers* (1861); *La Belle Hélène* (1865); *La Vie*



LUDOVIC HALÉVY.

*Parisienne* (1866); *La Grande-duchesse de Gérolstein* (1867); *La Périchole* (1868); *Les Brigands* (1870). He wrote, besides, a large number of vaudevilles and dramas, some of great merit, among them *Frou-frou* (with Meilhac, 1869); *Tricoche et Cacolet* (1872); *La Petite Mère* (1880). His *Madame et Monsieur Cardinal* (1873) and *Les Petites Cardinal* (1880) are humorous sketches of Parisian theatrical life. In 1882 he published the charming idyllic story *L'Abbé Constantin* (150 editions; many translations; a very successful play was built on its incidents), which was followed by *Criquette* and *Deux Mariages* in 1883. Halévy was admitted to the French Academy in 1886. In many of his most successful plays he had the collaboration of Henri Meilhac.

HALF-BREEDS OF MANITOBA. Half-breed is the name given in America to the offspring of Europeans (chiefly French and Spanish) and the women of native races. In Northwestern Canada, from the early days of the Hudson's Bay and the

Northwest Fur companies, the English and French traders intermarried with Indian squaws, which left a legacy of trouble to Canada in the half-breeds, or, as they sometimes are called, *bois-brûlés*, *coureurs du bois*, or French *métis*. During the French régime in Canada these people were engaged largely in the fur trade as trappers or *voyageurs*, and during the French and Indian wars at times were utilized as *coureurs du bois*. In later times they have become useful as lumbermen, raftsmen, and as guides in the woods and waterways of the continent. For these duties, and especially as woodsmen, these people seem peculiarly fitted. The free life of the forest and plains has inured them to hardship, and developed in them the highest endurance and courage. Few of them take kindly to agriculture or to town life; in the Canadian plains they still continue to lead a partly nomadic life, attaching themselves to hunting, exploring or surveying parties, or engaging in teaming for settlers, or herding on the plains. When Europeans first intruded as colonizers in the Northwest, the half-breeds, in two notable instances, rose in revolt, and necessitated the Canadian government sending a military force to quell the disaffection. It was from the half-breeds in the Red River country and along the banks of the South Saskatchewan, who had been despoiled of their holdings and deprived of their hunting-grounds, that trouble came, and it was this people, of semi-French origin, whom the outlaw, Louis Riel, cajoled into rebellion in 1869 and again in 1885. On the whole, however, the French-Canadian half-breed has been peaceful, and done not a little to promote good feeling between the red man and the white.

HALIBUT. See HOLBUT, Vol. XII, p. 58.

HALICORE. See DUGONG, Vol. VII, p. 516.

HALIFAX RIVER, a tidal inlet, in Volusia County, central eastern Florida, beginning with Mosquito Inlet and running north thirty miles. It is a mile wide, and is separated from the sea by a narrow strip of land from one quarter to one half mile in width. It abounds in fish and oysters, and is navigable at high tide.

HALIOTIS. See ABALONE, in these Supplements.

HALITE. See *Rock-Salt*, under GEOLOGY, Vol. X, p. 228.

HALITHERIIDÆ OR HALITHERIUM. See MAMMALIA, Vol. XV, pp. 390, 391.

HALL, ASAPH, an American astronomer; born in Goshen, Connecticut, Oct. 15, 1829; received a common-school education, and then went to work as a farm-hand and later as a carpenter; in 1853 managed to pay his way through Norfolk Academy, where he learned algebra and geometry; for several years afterward taught school in Wisconsin; for one year only, he attended the University of Michigan; then, from 1857 to 1862, he was assistant in the Observatory of Harvard University, and then became aid in the United States Naval Observatory in Washington, when, in 1863, he was made professor of mathematics, ranking as captain in the army. He has been

connected with all the important astronomical expeditions sent out under the United States government since 1863, and won great distinction by his discovery (Aug. 11-18, 1877) of the moons of Mars, which he named Deimos and Phobos (Terror and Fear). Professor Hall was elected a member of numerous scientific societies, both in this country and in Europe and received the gold medal of the Royal Astronomical Society (1878).

HALL, CHARLES HENRY, an American clergyman; born in Augusta, Georgia, Nov. 7, 1820; graduated at Yale in 1842; graduated at Genival Theological Seminary, New York City, and ordained a priest of the Protestant Episcopal Church in 1845; held several pastoral charges, the two more recent being the rectorate of the Church of the Epiphany, Washington, D. C., and his present parish of Holy Trinity, Brooklyn, New York. Took an active part in favor of the Cleveland candidacy, 1884. His theological views are broad and his eloquence both practical and popular; was often a co-worker in Henry Ward Beecher's enterprises; wrote *Commentaries of the Gospel* (1867); *Protestant Ritualism* (1871); and *Spina Christi* (1883). He was elected chaplain of the Twenty-third Regiment, National Guard, New York.

HALL, DOMINICK AUGUSTINE, an American jurist; born in South Carolina in 1765. He began the practice of law in his native State, but removed to Louisiana after its purchase by the United States in 1804, and was appointed district judge of Orleans Territory in 1809, holding the office till 1812, when Louisiana was admitted into the Union, when he became one of the United States judges. He had a serious disagreement with General Andrew Jackson when the latter ordered the city of New Orleans to be placed in a state of siege previous to the battle of New Orleans. Judge Hall having granted a writ of *habeas corpus* for the release of a member of the legislature arrested by the commanding general, Jackson refused to recognize the judge's authority, and had him arrested for violating martial law. As soon as he was released, Judge Hall called General Jackson to account for contempt of court, and sentenced him to pay a fine of one thousand dollars. The money was paid at once, but afterward was refunded by Congress. Judge Hall remained in the United States court till his death, which occurred in New Orleans, Dec. 12, 1820.

HALL, FITZEDWARD, an American philologist; born in Troy, New York, March 21, 1825; graduated as C.E. from the (Troy) Rensselaer Polytechnic Institute; sailed at once for Calcutta, where he devoted himself to the study of Sanskrit, Persian, Hindustani and Bengalee. In 1853 he was appointed professor in Benares College, and later to the inspectorship of government schools. In 1862 he accepted the chair of Sanskrit and Indian jurisprudence at King's College, London; was the first American to translate a Sanskrit text; discovered many Sanskrit works supposed to have been lost. He assisted in the

editorship of James A. H. Murray's great Historical Dictionary. Besides the publication of his Sanskrit "finds," he also wrote *Lectures on the Nyāya Philosophy* (1852); *Hindī Grammar* (with Dr. J. R. Ballantyne, 1868); a *Rational Refutation of the Hindu Philosophical Systems* (1852); *Recent Exemplification of False Philology* (1872), etc.

HALL, GERTRUDE, an American author and vocalist; is a native of Boston, the daughter of Edna Hall, a teacher of vocal music. Miss Hall was taken abroad to be educated when only seven years of age; was placed in a school at Florence, Italy, where she remained nine years. *Far from To-Day* and *Foam of the Sea* are two stories which she has published.

HALL, GRANVILLE STANLEY, an American philosopher and educator; born at Ashfield, Massachusetts, May 6, 1846; graduated from Williams College (1867); studied at Berlin, Bonn, Heidelberg and Leipsic; lecturer in Harvard and Williams (1876, 1881, 1882), after having spent four years as professor at Antioch College, Ohio (1872-76); professor of psychology at Johns Hopkins University (1882); president of the (new) Clark University, Worcester, Massachusetts (1888); wrote *Aspects of German Culture* (1881); *How to Teach Reading and What to Read in Schools* (1887); and numerous sketches in magazines devoted to psychology and pedagogy.

HALL, ISAAC HOLLISTER, American Orientalist; born in Norwalk, Connecticut, Dec. 12, 1837; graduated at Hamilton College (1859); tutor there (1861-63); lawyer in New York City (1864-75); professor in the American College, Beirut, Syria (1875-76); associate editor of the Philadelphia *Sunday School Times* (1877). In 1885 became one of the curators in the Metropolitan Museum of Arts, New York; gave much attention to the study of Cypriote inscriptions; discovered in Beirut (1876) a Syriac MS. of the Gospels, Acts and several Epistles dating back to A.D. 700 to 900; published it with notes and a few papers in fac-simile; published in phototype the Williams MS. of the *Antilegomena Epistles* discovered by him; published *A Critical Bibliography of the Greek New Testament as published in America*. Died in Mt. Vernon, N. Y., July 2, 1896.

HALL, JAMES, an American geologist and palæontologist, born at Hingham, Massachusetts, Sept. 12, 1811; graduated from the Troy Polytechnic Institute, 1832, and remained there from 1832 to 1836 as assistant professor of chemistry and natural sciences, and then became professor of geology. In the same year he was appointed assistant geologist of the geological survey of New York, and in 1837 was made state geologist in charge of the fourth district. He made his full report on the survey in 1843, and then was placed in charge of the palæontological work. In 1855 he was state geologist of Iowa, and in 1857 of Wisconsin. He refused the office of chief palæontologist in the Canadian geological survey, although promised the position of director general. In 1866 he was appointed director of the New York State museum, still retaining the office

of state geologist. He wrote numerous important reports on geological and palæontological subjects; laid the foundation of a rational theory of mountains; in 1884 received the quinquennial prize of \$1,000 awarded by the Boston Society of Natural History; was the founder (1840), and later the president of the American Association for the Advancement of Science (1856); received many honors, both here and abroad; was elected a corresponding member of the Academy of Sciences of France; and wrote over 250 papers of importance on his favorite subjects of study. Died at Echo Hill, near Bethlehem, N. H., Aug. 7, 1898.

HALL, JOHN, Presbyterian clergyman; born at Market Hill, Armagh Co., Ireland, July 31, 1829; was licensed to preach in 1849, and engaged in missionary labor in the west of Ireland. In 1852 he became pastor of the First Presbyterian Church at Armagh, and in 1858 of St. Mary's, Dublin. In 1867 he visited the United States as a delegate from the Presbyterian Church in Ireland to the Presbyterian churches in the United States; and in the



REV. JOHN HALL.

same year was summoned to take charge of the Fifth Avenue Presbyterian Church in New York. In 1881 he became chancellor of the University of the city of New York, resigning in 1891 because of the pressure of other duties. He was a man of broad ideas and an orator of great power; and he wrote *Family Prayers for Four Weeks* (1868); *Papers for Home Reading* (1871); *Familiar Talks to Boys* (1873); *Questions of the Day* (1873); *Foundation Stones for Young Builders* (1880); and *A Christian Home: How to Make and How to Maintain It* (1883). Died at Bangor, Down Co., Ireland, Sept. 17, 1898.

HALL, LYMAN, a signer of the Declaration of Independence; born in Connecticut in 1725; graduated at Yale (1747); studied medicine and removed to Sunbury, Georgia (1752); took an active part in the pre-revolutionary agitation; member of the Savannah conventions (1774-75), and instrumental in deciding Georgia to join the revolted colonies; served in Congress (1775-80); when the British occupied Georgia, all his property was confiscated, and he had to flee for his life; returned to Georgia (1782); governor for one term. He died in Burke County, Georgia, Oct. 19, 1790.

HALL, NEWMAN, an English clergyman; born in Maidstone, England, May 22, 1816; graduated from the London University (1835); began a law career, but soon changed for theology; from 1842 to 1854 was pastor of the Albion Congregational Church in Hull, and then went to London to take charge of Surrey Chapel, Blackfriars road. In 1867 and in 1873 he visited the United States, lecturing in the principal cities. Dr. Hall's publications include: *Come to Jesus* (circulation three million copies; translated into twenty languages); *The Christian Philosopher* (1849); *Italy, the Land of*

*the Forum and the Vatican* (1853); *Lectures in America* (1868); *Sermons and History of Surrey Chapel* (1868); *From Liverpool to St. Louis* (1869); *Prayer, its Reasonableness and Efficacy* (1875); *The Lord's Prayer* (1883); and *Songs of Earth and Heaven* (1885). His latest book is *Gethsemane; or, Leaves of Healing from the Garden of Grief*.

HALL, SAMUEL CARTER, an Irish author and editor; born at Geneva Barracks, County Waterford, Ireland, where his father commanded a regiment, May 9, 1800. In 1822 he went to London, studied law, and became a reporter for the *New Times*. In 1825 he established *The Amulet*, which he edited for several years; afterward succeeded the poet Campbell as editor of the *New Monthly Magazine*, and did other journalistic work before founding the *Art Journal*, which he edited from 1839 to 1880. He was an industrious worker and skillful compiler, the joint works written and edited by Mr. and Mrs. S. C. Hall (who was Anna Maria Fielding, and a writer of ability) exceeding 340 volumes. Among these were *Ireland* (1841-43); *The Book of Gems; British Ballads*, one of the fine art-books of the century; and *Baronial Halls*. He was an active worker in the temperance cause and a persistent philanthropist. His latest books, somewhat in the form of diaries and replete with interesting details, are *A Book of Memories of Great Men and Women of the Age* (1872); and *The Retrospect of a Long Life* (1883). In 1880 he received a civil-list pension of £150 a year. He died in London, March 16, 1889.

HALL, S. C., MRS. (ANNA MARIA FIELDING), an Irish authoress; born in Dublin, Jan. 6, 1805. At 15 years of age she went to London, where her education was completed and in 1824 married Samuel Carter Hall, whom she assisted in many of his works. She established a reputation of her own by her *Sketches of Irish Character* (1828); *Uncle Horace* (1837); *Lights and Shadows of Irish Character* (1838); *Marian; or, a Young Maid's Fortune* (1839, translated into German and Dutch); *Midsummer Eve* (1843); *The Whiteboy* (1845); and numerous shorter stories. Her dramas, *The French Refugee* (1837) and *The Groves of Blarney* (1838), met with fair success on the stage. She also contributed to the *Art Journal* and other periodicals, edited the *St. James's Magazine* for a year, and wrote various books for the young, some of them illustrated by her own pencil. She assisted in the formation of the Governesses' Benevolent Institution, and the Nightingale fund, the latter resulting in the endowment of a training-school for nurses. She died in East Moulsey, Surrey, Jan. 30, 1881.

HALLAM, ARTHUR HENRY. See HALLAM, HENRY, Vol. XI, p. 393.

HALLE, ADAM DE LA. See *Literature* under FRANCE, Vol. IX, p. 648.

HALLÉ, SIR CHARLES, Anglo-German pianist; born April 11, 1819, near Elberfeld, Germany. He studied chiefly in Paris, and acquired there a high reputation as an original interpreter of classical music. The revolution of 1848 drove him to London, where he soon came prominently into



notice. He subsequently settled in Manchester as director of the local conservatory. In 1857 he instituted a yearly series of classical concerts in London, and until his death they were given regularly with undiminished popularity, adding to his reputation as a virtuoso that of a conductor of great merit. His few compositions are erudite and dignified. Two of his children (by his first wife) are both distinguished in art circles; one (Charles E.) as a painter; the other, a daughter, as a sculptor. He edited *Classical Composers*, and did much for the culture of a high description of music. He was knighted in 1888. Died in Manchester, England, Oct. 25, 1895.

HALLÉ, LADY (WILHELMINE NERUDA), Austrian violinist virtuoso, wife of the preceding; born in Brünn, Moravia, March 20, 1840; pupil of Jansa; made her *début* in 1846 as an infant prodigy, and in 1849 played in London in De Beriot concerts at the Philharmonic; met with great success in Paris (1864); married, the same year, Ludwig Normann, a Swedish musician. In 1888, having been a widow for several years, she married Sir Charles Hallé. In 1899 she paid a professional visit to the United States and was well received.

HALLETT, HOLT SAMUEL, an English civil engineer; born July 16, 1841; educated at the Charter House and in the offices of William Baker, engineer-in-chief of the London and Northwestern railroad; in 1868 was appointed civil engineer under the government of India, and placed in charge of large tracts in British Burmah. With his friend, Archibald Colquhoun, he conceived the vast project of connecting India and China by railway. The survey for his plans entailed dangers of all sorts; but the two associates triumphed over all, and out of the 1,790 miles of road surveyed, the section up to Mandalay is completed, and the balance in a fair way. He wrote *A Thousand Miles on an Elephant in the Shan States* (1887).

HALLETTSVILLE, a town and the capital of Lavaca County, southeastern Texas, 100 miles W.S.W. of Houston, on the San Antonio and Aransas Pass railroad. It is the center of a cotton-raising region, and has cotton-gins and a cottonseed-oil mill. It is supplied with city water and electric lights. Population 1900, 1,457.

HALLEY'S COMET. See ASTRONOMY, Vol. II, p. 814.

HALLIWELL-PHILLIPPS, JAMES ORCHARD, an English antiquary and philologist; born in London, June 21, 1820. He studied for a time at Cambridge, and in 1839 began his long career as editor and publisher of old English authors and manuscript texts. His earlier work embraced plays, ballads, popular rhymes and folk-lore, chap-books and English dialects, but he gradually came to concentrate himself upon Shakespeare alone. At 36 he already had published 57 volumes on his favorite topics. In 1872 he succeeded to the property and name of Thomas Phillipps. This wealth he made use of in the accumulation of an unrivaled collection of Shakespearean books, manuscripts and rarities of every kind, in the entertainment of scholarly visitors, and in gifts of valuable books

to Edinburgh University, Stratford and Birmingham. His great work, however, was his *de luxe* folio edition of *Shakespeare's Works* (1853-65, in 16 volumes, with plates), with a *Life of Shakespeare* (1881). At the time of his death, which occurred in Brighton, Jan. 3, 1889, he was about publishing his *History of the English Stage*, the labor of thirty years of his life. See SHAKESPEARE, Vol. XXI, pp. 768-771.

HALL-MARKS. See PLATE, Vol. XIX, pp. 186, 187.

HALLOCK, GERARD, an American journalist; born at Plainfield, Massachusetts, March 18, 1800; graduated from Williams (1819); entered journalism by establishing the Boston (weekly) *Telegraph* (1824); became part owner of the New York *Observer* (1827); and in 1828 interested himself with David Hale in the publication of the *Journal of Commerce*, an old New York City daily; the partners fitted out a schooner to intercept European mail clippers off Sandy Hook, and organized a pony news-express between Washington and the office of their paper. Both moves made their reputation and their fortune. Mr. Hallock was a pro-slavery man, but very kind-hearted at the same time. Over one hundred fugitive slaves were freed with his own money. He was attached so strongly to his convictions, however, that upon the breaking out of the Civil War he was indicted as a rebel, and his paper was refused the privileges of the mail. He sold it at once, and retired from any interference in politics. He died in New Haven, Connecticut, Jan. 4, 1866.

HALLOWELL, a city of Kennebec County, southwestern Maine, on the west bank of Kennebec (navigable) River, 2 miles S. of Augusta. Cotton goods, oil-cloth, carriages, soap and candles are manufactured here, and in former times ship-building was carried on. Granite of a superior quality is quarried. It has an electric railway and a fine public library. Population 1900, 2,714.

HALLUCINATION. See INSANITY, Vol. XIII, p. 105.

HALM, FRIEDRICH, pseudonym of MÜNCH-BEL-LINGHAUSEN; q. v., in these Supplements.

HALMAHERA. See JILOLO, Vol. XIII, p. 692.

HALMSTAD, a seaport town in Halland province, Sweden, 70 miles N.W. of Christianstad; has a good harbor; exports oats and granite. Pop. 1896, 13,697.

HALOGENS. See CHEMISTRY, Vol. V, p. 490.

HALOID SALTS. See CHEMISTRY, Vol. V, 490.

HALPINE, CHARLES GRAHAM (Miles O'Reilly), an Irish-American soldier and author; born at Oldcastle, Ireland, Nov. 20, 1829; from a Protestant family; graduated at Trinity College, Dublin, 1846; married young, and engaged in journalism. In 1852 he moved to New York, joined the staff of the *Herald*, and his versatility opened for him the columns of a number of periodicals. He became associate editor of the New York *Times*, acted as war correspondent during Walker's filibustering expedition to Nicaragua, which terminated with the death of the adventurer. In 1850 he became part owner of the New York *Leader*, and made it a success. He also wrote for the

New York *Tribune*, and was the author of the famous abolitionist song:

"Tear down the flaunting lie,  
Half-mast the starry flag."

At the beginning of the Civil War he enlisted in a New York regiment; was immediately promoted lieutenant, and afterward served on Hunter's staff with the rank of major. While acting in this capacity he wrote for the New York *Herald* the series of articles purporting to be the production of one "Private O'Reilly." He served on General Halleck's staff, and with Hunter in the Shenandoah Valley, and received the brevet of brigadier-general of volunteers. After the war he edited the *Citizen*, a New York reform paper, and in 1867 was elected register of New York County by a coalition of the best people in both parties. He died a few months later, Aug. 3, 1868, from an excessive dose of chloroform administered accidentally. His poems were published in volume form under the titles of *Lyrics by the Letter H* (1854); *Baked Meats of the Funeral* (1866); and *The Poetical Works of Charles G. Halpin* (1869).

HALSBURY, HARDINGE STANLEY GIFFARD BAKON, an English lawyer and statesman; born in London, Sept. 3, 1825; graduated from Merton College, Oxford; called to the bar, 1850; became Queen's Counsel in 1865. He was engaged in most of the celebrated criminal trials of his time, including the Overend-Gurney and Tichborne cases. In 1875-80 he was Solicitor-General. On the accession to office of the Salisbury government, in 1885, he was made Lord Chancellor of England; was appointed to the same office when Lord Salisbury returned to power, 1886-92, and again in July, 1895. He was a remarkable exception to the rule of the English bar—that no Old Bailey practitioner ever reaches the woosack.

HAISEY, LEROY JONES, an American clergyman and author; born in Goochland County, Virginia, Jan. 28, 1812; graduated from Nashville (Tennessee) University (1834); tutor there (1834-36); studied theology at Princeton; licensed to preach (1840); pastor of the Presbyterian Church, Jackson, Mississippi (1843-48); pastor of the Chestnut Street Presbyterian Church, Louisville, Kentucky, (1848-58); in 1859 he was elected professor of pastoral theology, homiletics and church government in the Presbyterian Seminary of Chicago (now McCormick Theological Seminary); Emeritus professor, 1882; wrote *Literary Attractions of the Bible* (1859); *The Life and Pictures of the Bible* (1860); *The Life and Works of Philip Lindzey* (3 vols., 1866); and *Living Christianity* (1881). Died in Chicago, June 18, 1896.

HALSTED, BYRON DAVID, an American agriculturist; born in Venice, New York, June 7, 1852; graduated at the Michigan Agricultural College (1871); doctor of sciences, Harvard (1878); instructor in botany, Harvard (1874-75); became editor of the *American Agriculturist* (1875-84); professor of botany, Iowa Agricultural College (1884); author of *The Vegetable Garden* (1882);

*Farm Conveniences* (1883); *Household Conveniences* (1883).

HALSTED, MURAT, an American journalist; born in Paddy's Run, Butlers County, Ohio, Sept. 2, 1829; bred to farm life, and graduated from the Farmer's College, College Hill, Ohio, 1851; taught district schools and wrote for country papers; reporter on the Cincinnati *Commercial* (1853); part owner of the paper (1854); editor-in-chief (1856); proprietor (1867). In 1882 he became chief editor of the consolidated *Commercial and Gazette*, a majority of the stock being his. A fearless, independent Republican writer; editor of the *Standard-Union*, Brooklyn, New York (1890). His letters from Cuba (1895-96), afterward published as *The Story of Cuba*, created much sympathy for the insurgents.



MURAT HALSTED.

HALYS. See ASIA MINOR, Vol. II, p. 707.

HALYSITES, a genus of fossil corals, typical of the family of chain-corals (*Halysitidae*). They are characterized by the skeletons of the individual animals being united in a chain-like series. The name *Catenipora* is often applied to the chain-corals. They are all from Palæozoic strata.

HAMADRYADES. See DRYADES, Vol. VII.

HAMAMELIS OR WITCH HAZEL. See HAZEL, Vol. XI, 549; ARBORICULTURE, Vol. II, 320.

HAMBURG, a city and state of northwestern Germany. See HAMBURG, Vol. XI, pp. 404-09. The state reported, in the census of Dec. 1900, an area of 158 square miles and a population of 704,660. The state consists of two divisions, the population of each of which was as follows on December 21, 1895: City of Hamburg, 625,552; Landgebiet, 56,080, the population of the whole state increasing rapidly in the last few years; the number of foreigners is small in proportion. In 1897 the population of the city proper was 653,960. A large stream of emigration, chiefly to America, flows through Hamburg; but since 1891, when there were 144,000, the number of emigrants has rapidly decreased until 1897, when the number was 35,049. The jurisdiction of the Free Port was, on Jan. 1, 1882, restricted to the city and port by the inclusion of the lower Elbe in the Zollverein. On Oct. 15, 1888, the whole city, except a small portion, including the actual port and warehouses connected with it (population 1,585 in 1895), was incorporated in the Zollverein. The alterations in the port necessitated by this step involved an expenditure of about \$29,200,000, of which the imperial government contributed one-third. Hamburg is the principal port of Germany; in 1894 the number of ships which entered the port was 9,165, with a tonnage of 6,228,821, a considerable increase over any previous year; in 1897 the entries were 11,173, with a tonnage of 6,708,070. In 1897 the clearances were 11,293 ships, of 6,851,987 tons. In 1896 there were 23

miles of railroads. During 1892 Hamburg suffered very severely from an epidemic of Asiatic cholera, introduced by emigrants from infected districts in Russia.

**HAMBURG**, a city of Fremont County, southwestern Iowa, situated on the Nishnabotna River, near the Missouri, 12 miles S.E. of Nebraska City, on the Chicago, Burlington and Quincy and the Kansas City, St. Joseph and Council Bluffs railroads. It has flour mills and a foundry. It is the shipping and trading point for the fruit and stock-raising vicinity. Population 1890, 1,634; 1900, 2,079.

**HAMBURG**, a post borough of Berks County, southeastern Pennsylvania, at the foot of Blue Mountain, on the east bank of the Schuylkill River and on the Philadelphia and Reading railroad. It has a rolling-mill, foundries, tanneries and steam-mills, and several German weekly newspapers. Population 1900, 2,315.

**HAMERLING, ROBERT**, an Austrian poet; born in Kirchberg, Austria, March 24, 1830. He attended the gymnasium in Vienna, and while still a boy wrote several dramas; after the insurrection of 1848 he entered the university, where he studied philology and philosophy; from 1855 to 1866 he was professor in the gymnasium at Trieste, resigning on account of ill-health. He then returned to Graz, where he had been a teacher for a short period, and devoted the rest of his life to authorship. The following are among his most popular works, most of them having passed through several editions. A collection of lyrical poems, *Sinnen und Minnen; Schwanculied der Romantik; Germanenzug; Ahasver in Rom*, which had a great success; *Der König von Sion; Danton and Robespierre; Die Sieben Todsünden* and *Die Atomistik des Willens*, published after his death. By some, *Ahasver in Rom* and *Der König von Sion* are classed among the finest German epics. Died in Graz, July 13, 1889.

**HAMERTON, PHILIP GILBERT**, an English etcher and writer on art; was born at Laneside, near Shaw, Lancashire, Eng., Sept. 10, 1834; died at Boulogne, Nov. 5, 1894. In early life his love for landscape painting drew him to the Highlands of Scotland, where he lived for awhile, but marrying a French lady he afterward for a time took up his abode in France, on the art of which country, together with its literary circles, he subsequently wrote much. In 1869, after



PHILIP G. HAMERTON.

studying art on the European continent, and having become a proficient etcher, he founded *The Portfolio*, a high-class art magazine, which he long edited, and in which many of his critical and art contributions appeared. In this and similar congenial work he labored for a quarter of a cen-

tury, accomplishing great things for art, and writing many instructive monographs on painting and the great painters. As a critic, he was well-informed and enthusiastic, and at the same time took a sympathetic interest in literature. His chief writings, besides a volume of poems, the fruit, in the main, of his sojourn in the Scottish Highlands, are *Thoughts about Art*, and *A Painter's Camp in the Highlands* (1862); *Etching and Etchers* (1868); *Contemporary French Painters* (1868); *Painting in France after the Decline of Classicism* (1869); *The Sylvan Year*, and *The Unknown River* (1870); *The Etcher's Handbook* (1871); *Chapters on Animals*, and an inspiring work on *The Intellectual Life* (1873); *Round My House* (1875); *Modern Frenchmen*, five biographies of Gallic artists (1878); *Life of J. M. W. Turner* (1879); *The Graphic Arts*, drawings, etc., exemplifying the various branches of art (1882; new ed., 1892); *Human Intercourse* (1884); *French and English, a Comparison* (1889); *Man in Art*; studies in religious and historical art, portrait, and genre work (1892); *The Present State of the Fine Arts in France* (1892); *Drawing and Engraving* (1893); *Autobiography* (incomplete, but supplemented by his widow); and two novels, *Wenderholme* (1869); and *Marmorne* (1878). His principal writings, in 14 volumes, have appeared in a Boston reprint.

**HAMILTON**, a town and the capital of Marion County, northwestern Alabama, on the Butta-hatchee River. Nearest station, Guin, 14 miles south, on the Kansas City, Memphis and Birmingham railroad. It is a farming center. Population 1900, town and precinct, 1,667.

**HAMILTON**, a town on Great Bermuda at the head of Great Sound, capital of the Bermuda Islands. It is irregularly built, and its chief occupation is raising early vegetables and flowers, mainly for New York markets, and shipping. Population, 8,000.

**HAMILTON**, a city, port of entry and capital of Wentworth County, Ontario, Canada, at the head of Lake Erie. (For full account of its industries, institutions, etc., see Vol. XI, p. 411.) Population 1881, 35,961; 1891, 48,980.

**HAMILTON**, a city of Hancock County, western Illinois, opposite Keokuk, Iowa, on the Mississippi River, and at the foot of Des Moines Rapids, on the Toledo, Peoria and Western railroad. It is an excellent fruit region, has abundant water-power, and several manufactories. Population 1890, 1,301; 1900, 1,344.

**HAMILTON**, a post village of Caldwell County, northwestern Missouri, 50 miles E. of St. Joseph, on the Hannibal and St. Joseph and the Hamilton and Kingston railroads. It has machine-shops, flouring-mills, and is a shipping-point for grain, cattle, horses and hogs. Population 1890, 1,641; 1900, 1,804.

**HAMILTON**, a village of Madison County, central New York, 27 miles S.W. of Utica, on the New York, Ontario and Western railroad. Colgate University and Hamilton Theological (Baptist) Seminary are situated here. Population 1890, 1,744; 1900, 1,627.

HAMILTON, a city and the capital of Butler County, southwestern Ohio, located on both sides of the Miami River, on the Miami canal and the Cincinnati, Hamilton and Dayton, the New York, Lake Erie and Western and the Pittsburg, Cincinnati, Chicago and St. Louis railroads. The city controls and operates its own gas and water-works, and there is a private gas and electric company. Electric street-railways traverse the principal streets. North of the city the river is turned from its channel into an immense reservoir, which feeds a system of hydraulics, and gives fine power to the factories. There are several national and other banks. The public schools are of a high order, and occupy fine buildings. There is a free library and charitable institutions, such as a children's home and the county infirmary. The county court-house, completed in 1890, is a fine building, and cost \$300,000. Greenwood Cemetery, with its beautiful lake, is well situated; and the city has three public parks. Safe and lock works, stove-foundry, buggy factory, carriage factory, Corliss engine-works, canning factory, a hosiery-mill, autographic register factory, shop for making laundry machinery, and many other enterprises have been recently established. The older industries of this city embrace the manufacture of paper, woolen cloth, tile and flour. With its plentiful opportunities for employment the city grows rapidly. Population 1800, 17,505; 1900, 23,914.

HAMILTON, FRANK HASTINGS, an American surgeon; born at Wilmington, Vermont, Sept. 10, 1813; graduate of Union College, and received his medical degree from University of Pennsylvania in 1835; was chosen professor of surgery in the Western College of Physicians and Surgeons, Fairfield, New York, in 1839; and the next year was called to the medical college in Geneva, New York. In 1846 he became professor in the Buffalo Medical College, and in 1859 was elected to fill the chair of principles and practice of surgery in the Long Island College Hospital, where he remained until the war broke out. For two years he served as surgeon in the army, and attained the rank of lieutenant-colonel. From 1868 to 1875 he was professor of surgery in the Bellevue Hospital Medical College, and was surgeon to the hospital from 1863 to his death, and, during President Garfield's last illness, was one of the consulting physicians. Besides numerous contributions to medical journals, Dr. Hamilton wrote *Treatise on Strabismus* (1844); *Treatise on Fractures and Dislocations* (1860); *Practical Treatise on Military Surgery* (1862); and *The Principles and Practice of Surgery* (1872). Died in New York City, Aug. 11, 1886.

HAMILTON, GAIL. See DODGE, MARY ABIGAIL, in these Supplements.

HAMILTON, GEORGE FRANCIS, LORD, an English statesman; born at Brighton in 1845; he was elected to the House of Commons in 1868 and has served constantly since, representing Middlesex, and, later, the Ealing division of the same county; became Under-Secretary for India in

1874, and four years later succeeded Lord Sandon as vice-president of the Committee of Council on Education, and on the latter occasion was sworn of the Privy Council. In 1885 Lord Salisbury nominated him First Lord of the Admiralty, which office he held also under Salisbury's administration. Lord George was made governor of Tasmania in January, 1887, and in 1894 was elected chairman of the London School Board.

HAMILTON, JAMES, an American statesman; born in Charleston, South Carolina, May 8, 1786; was admitted to the bar; practiced in Charleston; served in the War of 1812 as a major; and for several years was mayor of Charleston. He was several times a member of the legislature, and from 1822 to 1829 was a member of Congress. He was elected governor in 1830. Subsequently he removed to Texas, which state he represented in Europe, trying to secure its recognition as a republic, and at the time of his death was a United States Senator-elect from that state. He was one of the founders of the Bank of Charleston and the *Southern Quarterly Review*. Drowned off the coast of Texas, Oct. 15, 1857.

HAMILTON, JAMES, an American artist; born in Ireland, in 1819; emigrated to Philadelphia, Pennsylvania, and in 1856 began furnishing illustrations for books. He illustrated Dr. Kane's *Arctic Explorations*, the *Arabian Nights*, the *Ancient Mariner*, and other popular works. Among his pictures are *Capture of the Serapis*, *Old Ironsides*, *Wrecked Hopes*, *Egyptian Sunset*, *Morning off Atlantic City*, and *Moonlight Scene Near Venice*. His oil paintings are chiefly marine views. He died in Philadelphia, in 1878.

HAMILTON, SIR ROBERT GEORGE CROOKSHANK, a British statesman; born in 1836, in Shetland. He was educated at the University of Aberdeen; entered the civil service; was afterward a War Department clerk, and later was in the Office of Works and the Education Department. After being accountant, later assistant-secretary of the Board of Trade, and two years later (1874) secretary to the Civil Service Inquiry Commission, he was appointed Under-Secretary to the Admiralty. In the same year, 1882, he was made Under-Secretary for Ireland, which position he filled until 1886, when he was appointed governor of Tasmania, which office he held until 1893, when he was named a commissioner to inquire into the affairs of Dominica.

HAMILTON COLLEGE, an institution of higher learning, at Clinton, Oneida County, New York; founded in 1793 as Hamilton Oneida Academy, and chartered as a college in 1812, its first trustee being Alexander Hamilton. It is non-sectarian, but under Presbyterian influence. The attendance averages about 160, all young men, and its faculty numbers 17. The property belonging to the institution is valued at about three quarters of a million dollars, including grounds and buildings. Some \$370,000 of this is productive, and together with all other sources furnishes an income of \$30,000. The campus is a fine park of forty acres, situated on the Oris-

kany. The buildings comprise three halls, a chapel, memorial hall, observatory, gymnasium, library, boarding-hall, hall of natural history and chemical laboratory. The library, which is rapidly increasing in size, has at present 34,000 volumes. The Litchfield Observatory has long been noted for the superior excellence of its service, and here Dr. Christian Peters did much valuable work, some of it of international fame.

The college has two courses, classical and Latin-scientific, while particular attention has always been given to rhetoric and oratory. The prize system is quite elaborate; the college societies are strong and active, and the students publish the *Literary Monthly*. The first class graduated in 1814, and since then 2,390 have received their degrees.

The presidents of the college have been Rev. Azel Backus, Rev. Henry Davis, Rev. Sereno Edwards Dwight, Rev. Joseph Pumey, Rev. Simon North, Rev. Samuel Ware Fisher, Rev. Samuel Gilman Brown, Rev. Henry Darling, Rev. Melancthon Woolsey Stryker, at present head of the institution.

HAMILTON GROUP. See GEOLOGY, Vol. X, p. 345.

HAMLEY, SIR EDWARD BRUCE, a British general; born at Bodwin, in Cornwall, England, April 27, 1824; graduated from Royal Military Academy, Woolwich; entered the service in 1843, and rose gradually until he was made lieutenant-general in 1882; served throughout the Crimean War and in the Egyptian campaign, 1882; was commandant of the Staff College, 1870-77. He received the Crimean medal, the Egyptian War medal, and eight other decorations. In 1854 he produced a charming tale called *Lady Lee's Widowhood*, on which the drama *Rosedale* was founded. His *Operations of War* (1866), of which several editions have appeared, is a standard text-book for military examinations. He also wrote *The War in the Crimea* (1855; 3d ed., 1891); *Voltaire* (1877); *Shakespeare's Funeral and Other Papers* (1889); *National Defence* (1889); and several other books and pamphlets on various subjects, especially against Irish Home Rule. He was Conservative member for Birkenhead, 1885-92. Died in London, Aug. 12, 1893.

HAMLIN, ALFRED DWIGHT FOSTER, an American architect; born at Constantinople, Turkey, Sept. 5, 1855. He was educated at Amherst College and Massachusetts Institute of Technology, and later studied at the *École des Beaux-Arts*, Paris. Was instructor, and later rose to be professor of architecture in the School of Mines, Columbia College. He was author of a series of papers on *Architectural Shades and Shadows* and *Handbook of the History of Ornament*.

HAMLIN, CYRUS, an American missionary and scholar; born at Waterford, Maine, Jan. 5, 1811; was a graduate of Bowdoin College, 1834; a missionary in Turkey from 1838 to 1876; during this time he founded Robert College, in spite of much opposition from the Turkish authorities, and, later, became head of the institution until 1876, when he returned to America

and became professor of dogmatic theology in Bangor Theological School (1877), and later was president of Middlebury College until 1885, when he removed to Lexington, Massachusetts. Wrote *Among the Turks*, and in 1893 published *My Life and Times*.

HAMLIN, HANNIBAL, an American statesman; born at Paris, Maine, Aug. 27, 1809. After being a printer he was admitted to the Maine bar in 1838, and from 1836 to 1840, and again in 1847, was a member of the legislature, serving a number of years as speaker. In 1842 he was elected to Congress, and re-elected in 1844. In 1848 he was elected United States Senator to fill a vacancy caused



HANNIBAL HAMLIN.

by the death of Senator Fairchild, and was re-elected in 1851; was still a member of that body when, in 1856, he joined in forming the Republican party; resigned in 1857 to serve as governor of his state, but resigned when he was again chosen United States Senator. He held this last position until 1861, when he again resigned, and became Vice-President with Mr. Lincoln. His term expired in 1865. Mr. Hamlin was collector of customs for the port of Boston under President Johnson, and later United States Senator from Maine, from 1875 to 1881, when he was sent as United States minister to Spain. He retired from public life on his return to this country, and held no other office until his death. While in Congress and Senate he was always strongly anti-slavery. Died at Bangor, Maine, July 4, 1891.

HAMLIN UNIVERSITY, an educational institution at Hamline, St. Paul, Minnesota. It was founded in 1854 at Red Wing, Minnesota, and named in honor of Bishop L. L. Hamline of the Methodist Episcopal Church, who furnished the nucleus for its endowment; in 1869 the school was closed on account of lack of funds; was removed to present site and opened again in 1880; was destroyed by fire in 1883, but continued running while being rebuilt. The property of the university is valued at \$310,000, of which \$180,000 is in grounds and buildings and some \$80,000 in productive property and securities, which, together with other sources, furnishes an income of \$16,000. The library has 6,000 volumes; the average attendance is 300 students, with 11 instructors. The school is co-educational, and under the control of the Methodist Episcopal Church. The collegiate department furnishes instruction in the classical and scientific courses. There are also musical and preparatory departments. President, Rev. G. H. Bridgman.

HAMMERHEAD. See SHARK, Vol. XXI, p. 776.

HAMMOND, a city and railroad center of Lake County, northwestern Indiana, 20 miles

from Chicago, on 11 railroad branches, and three miles from Lake Michigan. It has large steel works and an extensive slaughter-house, killing 2,500 cattle daily; nail-mills, axle and spring factories, a foundry, starch-works, and street-railways and electric lights. Population 1890, 5,428; 1900, 12,376.

**HAMMOND, JAMES HENRY**, an American statesman; born in Newberry County, South Carolina, Nov. 15, 1807. He was admitted to the bar in 1828 and, in 1830 became editor of the *Southern Times*, published at Columbia, South Carolina. In 1835-36 he was a member of Congress, and from 1842 to 1844 was governor of South Carolina. From 1857 to 1860 he was a United States Senator, retiring on the secession of South Carolina. He published letters on the slavery question and wrote several articles on agriculture, manufacture, banks, etc., and a review of the life of John C. Calhoun. Died at Beech Island, South Carolina, Nov. 13, 1864.

**HAMMOND, JOHN HAYES**, an American mining engineer, was born in California, in 1857, the



J. HAYES HAMMOND.

son of Major Richard Hammond. He was educated at the Sheffield Scientific School at Yale, and completed his education as a mining engineer at the Mining College at Freiberg, in Germany, where he graduated with high honors. Returning to California, he was appointed assistant in the department of mining and mineral statistics in the California State Census of 1880. Then he became superintendent of the Sonora silver-mines in Mexico, and was interested in mining properties in the Cœur d'Alene district of Idaho. He worked up a large business, became well known in European investors' circles, and was president of the Bunker Hill Mining Company.

In June, 1893, he left San Francisco to act as expert mining adviser in South Africa to Abraham Barnato, the wealthy speculator. His abilities in the Witwatersrand gold-fields were so marked that his services were secured by the Chartered South African Company as their mining adviser. As such he inspected the Bechuanaland, Matabeleland and Mashonaland gold-fields, and drafted the mining laws and regulations for these districts on the model of the American mining laws. He was described by the *London Times* as "The greatest living authority on quartz-mining."

In January, 1896, he was one of the leaders of the Uitlander Reform agitation in Johannesburg, and signed the appeal to Dr. Leander Starr Jameson, to come to the Uitlanders' aid. He subsequently countermanded the request and expressly desired Dr. Jameson to postpone the attempt. Jameson started Dec. 29, 1895, and surrendered at Doornkop, 6 miles from Johannesburg, on Jan.

2, 1896. The leaders of the Reform Committee, including John Hayes Hammond, were arrested on charges of high treason, and were for some days confined in a veritable Black Hole, which served as a jail at Pretoria. Hammond was in precarious health, and after much discussion was released on bail. On April 27th he was arraigned before an Orange Free State judge in Pretoria, and, on a plea of guilty, was, the following day, sentenced to be hanged. This excessive penalty was immediately commuted, and on May 20th, was reduced to fifteen years' imprisonment. On June 11th the sentence was finally mitigated to a fine of \$125,000 each on the principal reformers, and banishment, in the case of refusal to abjure civil rights, for fifteen years. Hammond then left the Transvaal and came to England to give evidence in the Parliamentary inquiry into the Jameson Raid.

**HAMMOND, SAMUEL**, an American soldier; born in Richmond County, Virginia, Sept. 12, 1757. He served in the Indian wars of the American Colonies, and in the Revolution, during which he was twice wounded, and attained the rank of colonel of cavalry. After the war he was appointed surveyor-general of Georgia, and from 1803 to 1805 was in Congress. From 1805 to 1824 he was military and civil commandant of Upper Louisiana, the latter part of which time he was receiver of public moneys in Missouri. Was afterward a member of the legislature in South Carolina; was surveyor-general, and from 1831 to 1835, Secretary of State. Died at Augusta, Georgia, Sept. 11, 1842.

**HAMMOND, WILLIAM ALEXANDER**, an American physician, born at Annapolis, Maryland, Aug. 28, 1828. He graduated from the University of New York as a medical doctor in 1848, and entered the United States army in 1849 as assistant surgeon, leaving the service in 1860, after which he accepted a professorship of anatomy and physiology in the University of Maryland. At the beginning of the Civil War he again entered the army, and in 1862 was appointed surgeon-general, with the rank of brigadier-general; was dismissed on charge of irregularities in liquor contracts, but this sentence was afterward reversed by the President and Congress and he was restored to his full rank. In 1867 he became a professor in Bellevue Hospital Medical College, and then a member of the faculty of the University of the City of New York, medical department. In 1882 he lectured on diseases of the nervous system, in the New York Post-Graduate Medical School. Among his published works are *Physiological Memoirs* (1863); a *Treatise on Hygiene*, with special reference to the military service (1863); *Sleep and Its Derangements* (1869); *Diseases of the Nervous System* (1871); *Lal* (1884); *A Strong-Minded Woman* (1885); *On the Susquhanna* (1887). In 1889 he removed to Washington, District of Columbia, where he now resides.

**HAMMONTON**, a village of Atlantic County, southeastern New Jersey, on the Camden and Atlantic and the Philadelphia and Atlantic City

railroads, half way between Philadelphia, Pennsylvania, and Atlantic City, New Jersey. Much fruit is grown here, and the village has manufactories of boots and shoes. Population 1890, 3,833; 1900, 3,481.

HAMPDEN, mountain in Mashonaland, South Africa, 8 miles N.W. of Salisbury.

HAMPDEN SIDNEY COLLEGE, an educational institution, located at Hampden Sidney, Virginia; organized in 1783, although it had been founded in 1775 by the Presbyterians of Hanover. While under Presbyterian influence, it is yet non-sectarian. The college stands on a campus of 250 acres, part of which was given by Peter Johnson in 1773. Besides this the school owns \$140,000 worth of income-bearing property, and has a total annual income of \$12,500. In 1898 there were 9 instructors and 128 students. The library contains 16,000 volumes. The course is strictly that of a college, but allows considerable latitude in the choice of studies. Among its founders were James Madison and Patrick Henry. President, Richard McIlwaine, D. D.

HAMPTON, a village and capital of Franklin County, Iowa, situated on the Central railroad of Iowa, 29 miles S. of Mason City. It contains a court-house, several churches and a high school, and has water-works, electric lights, etc. Population 1890, 2,067; 1900, 2,727.

HAMPTON, a town and the capital of Elizabeth City County, southeastern Virginia, on the north side of Hampton Roads, two miles from Fortress Monroe. The principal trade is in oysters, fish and garden produce. The village contains a famous normal and agricultural school, organized in 1868, for Indians and colored youth. This school was organized in 1870 for the education of colored youth; but since 1878 Indians have been admitted. The school was founded by General Samuel Chapman Armstrong. The curriculum comprises courses in English, industrial, agricultural and military education. The attendance, both males and females, is about 650, with a corps of 80 teachers. Teachers are prepared who later work among their own people. A national cemetery is here, and an asylum for disabled soldiers. The small harbor opens into Hampton Roads. Population 1890, 2,513; 1900, 3,441.

HAMPTON, WADE, an American soldier; born in South Carolina, in 1754; he served with distinction in the Revolutionary War; was a member of Congress from 1795 to 1797 and from 1803 to 1805, and in the War of 1812 was a major-general, but resigned in 1814 and retired to his home, in South Carolina, where he applied himself to increasing his wealth. At the time of his death he was the wealthiest planter in the United States, and the owner of three thousand slaves. He died Feb. 4, 1835.—His son, WADE HAMPTON, a soldier; born in South Carolina in 1791; was a lieutenant of dragoons in 1813, and acting inspector-general and aide-de-camp to General Jackson at New Orleans in 1815. Died in Mississippi, in 1858.

HAMPTON, WADE, a United States Senator, and grandson of General Wade Hampton; born at

Charleston, South Carolina, March 28, 1818; was educated at South Carolina University; served in the legislature, where he opposed secession, but entered the army at the outbreak of the war; rose from private to lieutenant-general, and had command, first, of all Lee's cavalry, and later, Johnston's. He was governor of South Carolina in 1878, and United States Senator from 1879 to 1891, and served on Senate Committee of Coast Defense. In 1893 he became United States Commissioner of Railways.



WADE HAMPTON

HAMPTON ROADS, the deep, broad channel opening from Chesapeake Bay into the James River, just south of lat. 37° n. It was the scene of important operations during the Civil War, especially the famous battle between the *Monitor* and *Virginia* or *Merrimac*. Since the war it has been a summer and winter resort, among its attractions being the famous Fortress Monroe.

HANAFORD, PHEBE ANN, an American authoress; born on the island of Nantucket, May 6, 1829; was educated in the public schools and under Rev. Ethan Allen, rector of St. Paul's Episcopal Church there; married Joseph H. Hanaford in 1849, and was ordained as a minister of the Universalist Church in Hingham, Massachusetts, in 1868, and afterward was called to New Haven, Connecticut, in 1870. Besides being several times chaplain of the Connecticut legislature, she has been grand worthy chaplain of the Good Templars, and represented the grand lodge at Detroit in 1867. She has conducted several lecture tours, has published many poems and made various contributions to literature. Among other works she has published *Lucretia, the Quakeress; The Best of Books and Its History; Abraham Lincoln; The Soldier's Daughter; The Captive Boy of Terra del Fuego; From Shore to Shore, and Other Poems; Charles Dickens; Women of the Century; etc.*

HANCHINOL (*Nesca salicifolia*), a Mexican plant of the family *Lythraceae*, with lanceolate leaves and flowers on one-flowered stalks. It is esteemed as a medicine.

HANCOCK, a village of Houghton County, northern North Michigan, situated on Portage Lake, opposite Houghton. It is connected with Lake Superior by a ship-canal, is a terminus of the Mineral Range railroad, and derives its prosperity from its location in the heart of the famous Lake Superior copper region. The village contains several copper-mines, smelting furnaces, stamping-mills, saw-mills and foundries. Population 1890, 1,772; 1900, 4,050.

HANCOCK, a village of Delaware County, southeastern New York, on the Delaware River, at the entrance of the East branch, and the New York, Lake Erie and Western railroad. It has bluestone quarries, tanneries, flour-mills and wood-alcohol factories. Population 1890, 1,279.

**HANCOCK, CAPE.** See **CAPE DISAPPOINTMENT**, in these Supplements.

**HANCOCK, WINFIELD SCOTT**, an American soldier; born in Montgomery County, Pennsylvania, Feb. 14, 1824.



GEN. W. S. HANCOCK.

He graduated at West Point in 1844, served with credit in Scott's campaign in Mexico, and on frontier duty until 1861, when he held the rank of captain. Having been appointed brigadier-general of volunteers in 1861, he served in the Army of the Potomac throughout its existence. For distinguished service on the peninsula and at South Mountain and Antietam, he was given a division and the rank of major-general, and in 1863 he was placed in command of the Second Corps, for his services at Fredericksburg and Chancellorsville. His crowning glory was won at Gettysburg. Reynolds fell on the first day, and Hancock was sent forward by Meade to arrange the line until the commander could arrive. On the second and third days Hancock commanded the left center, on Cemetery Ridge, where, just in the moment of victory, he was severely wounded. He received the thanks of Congress, and returned to the command of his corps early in 1864, in time to take part in Grant's campaigns of that year. He distinguished himself again and again at the Wilderness, at Spottsylvania and in the Cold Harbor and Petersburg operations. At the end of the war he commanded various departments, having been made a major-general in the regular army. While in command of the Department of Missouri, he led an expedition against the Indians of the plains. From September, 1867, to March, 1868, he commanded the Department of the Gulf, under the reconstruction acts; and certain orders issued by him, particularly those of Nov. 29 and Dec. 5, 1867, declaring that the military power was meant only to uphold, not to control, the civil power, and declining to exercise arbitrary powers, were so satisfactory to the Democratic party that in 1880 it nominated him for the Presidency. He was defeated by General James A. Garfield, but retained his position as senior major-general of the army and commander of the Department of the Atlantic, and the warm regard of the country. He was in chief command at Grant's military funeral in 1885. He died at Governor's Island, New York, Feb. 9, 1886.

**HAND.** See *Manus*, under **MAMMALIA**, Vol. XV, pp. 359, 360; and **SKELETON**, Vol. XXII, pp. 117, 118.

**HANDBORO**, a small village and summer resort of Harrison County, southern Mississippi, three miles N. of the Gulf of Mexico, on Bayou Bernard. It has saw-mills, machine-shop, carriage-shop and a shipyard. Population 1890, 1,021.

**HAND-TREE**, a common name applied to the Central American *Cheiroskemon platanoides*, a tree of the family *Malvaceæ*, or mallows. The name, both common and technical, refers to the five-curved anthers, taken to represent fingers. The tree is said to have been regarded as sacred in Mexico.

**HANGING GARDENS OF BABYLON.** See **BABYLON**, Vol. III, p. 183.

**HAN KEANG RIVER.** See **CHINA**, Vol. V, p. 632.

**HANNIBAL**, a city of Marion County, northeastern Missouri, on the west bank of the Mississippi River. (See Vol. XI, p. 445.) The population and business have had a steady and healthy growth during the last two decades. It has eight railroads, being the terminus of six trunk lines, which, with competitive river steamers, afford excellent facilities for shipping. The city has broad and handsome streets, well paved, and lighted by electricity. Gas is used chiefly for private lighting. A new electric-motor line of street-railway recently completed gives rapid transit to residence portions of the city. The water-supply is taken from the river two miles above the city, is passed by gravity through a system of filters, and then pumped into reservoirs. In 1890 the public sewer was completed, extending to all parts of the city. At that date there were 17 churches, Hannibal College (Methodist), 5 excellent modern school-buildings, and a free public library, with 10,000 volumes. There are also several good private schools. The banks are in good condition. Hannibal has a number of factories, such as foundries, machine-shops, lumber-mills, flour-mills, lime-kilns, and brick-yards. Pop. 1890, 12,857; 1900, 12,780. See also **HANNIBAL**, Vol. XI, p. 445.

**HANOL.** See **TONG-KING**, Vol. XXIII, p. 440.

**HANOTEAU, HECTOR**, a French landscape-painter; born at Decize, Nièvre, France, May 25, 1823. He early developed a disposition for drawing, and gave himself up to his favorite line, landscape-painting, which he studied under Gigoux. His works have been on exhibition in the salon since 1855, and have become favorites from frequent reproduction. Member of the Legion of Honor after 1870, and received a first-class medal at the Paris Exposition, 1889. Among his works are *Village Pond*; *Frogs*; *Paradise of Gusi*; *Sleeping Waters*; *Binage in Autumn*; and *Banks of the Loire*. He died at Briey, Nièvre, April 9, 1890.

**HANOVER**, a post-village of Jefferson County, southeastern Indiana, on the Ohio River, 5 miles below Madison. It contains Hanover College, which is under Presbyterian control.

**HANOVER**, a post-village of Grafton County, southwestern New Hampshire, on the Connecticut River, over which is a bridge connecting with Norwich, Vermont. It is the seat of Dartmouth College, and has considerable lumber trade. Population 1890, 1,817; 1900, 1,884.

**HANOVER**, a post-hamlet of York County, southern Pennsylvania, on the Pennsylvania and the Western Maryland railroads, 35 miles S. of



Harrisburg. The country surrounding abounds in iron ore. The articles manufactured are carriages, cigars, flavin and leather. Population 1890, 3,746; 1900, 5,302.

HANS BREITMANN. See LELAND, CHARLES GODFREY, in these Supplements.

HANSBROUGH, HENRY CLAY, an American journalist and statesman; born in Prairie du Rocher, Illinois, Jan. 30, 1848. He received a common-school education; removed to California with his parents in 1867, where he became a printer; was connected with newspapers in San José and San Francisco, California; Chicago, Illinois, and at Baraboo, Wisconsin. Removed to Dakota in 1882, and in 1883 established a newspaper at Devil's Lake. Served two terms as mayor of Devil's Lake; was a delegate to the National Republican Convention of 1888; was elected to the Fifty-first Congress as the first Representative at large from the state of North Dakota. In 1891 he was elected by the North Dakota legislature to the United States Senate to succeed Gilbert A. Pierce.

HANSI, a town of the district of Hissar, in the province of Punjab, northern India, about 80 miles W.N.W. of Delhi, on a railroad. It was a British cantonment from 1802 down to the mutiny of 1857. Population, 13,563.

HANTS, same as HAMPSHIRE (q.v., Vol. XI, p. 430).

HANUMAN. See APE, Vol. II, p. 151; and ENTELLUS MONKEY, in these Supplements.

HAPLOMI, a suborder of fishes with representatives in all parts of the world. There are three families, the pikes (*Esocidae*), the mud-minnows (*Umbridae*) and the minnows (*Cyprinodontidae*). The pikes are mostly valuable food-fishes, while none of the minnows are of economic importance.

HAPUR OR HAUPER, a town of India, in the Northwest Provinces, 23 miles S. by E. of Meerut. The western portion is substantially built, and the streets metaled and drained; the eastern half resembles a large agricultural village, full of cattle. A famous government stud was formerly maintained here. Population 1891, 14,294.

HARA-KIRI ("belly-cut"), sometimes called HAPPY DISPATCH, a system of official suicide formerly practiced in Japan, obsolete since 1868. Military men, and persons holding civil offices under the government, were bound, when they had committed an offense, to disembowel themselves. This was performed with elaborate formalities, in the presence of officials and other witnesses. Personal honor having been satisfied by the suicide's self-inflicted wound, his head was struck off by his second, often a kinsman or friend of gentleman's rank; but for the last two hundred years it has been the custom for the second to strike as soon as the principal reached for the knife. This mode of suicide was also resorted to by persons who had suffered unendurable affront which could not otherwise be satisfied, the harakiri being regarded not only as an honorable

expiation of crime, but as a blotting out of disgrace. It was necessary, however, to receive permission from the court, as otherwise the estate of the suicide was in danger of confiscation.

HARBAUGH, HENRY, an American theologian; born near Waynesboro, Pennsylvania, Oct. 24, 1817. After taking a partial course in academic and theological studies he was ordained in 1843, and sent to Lewisburg, Pennsylvania. From 1850 to 1860 he was pastor in Lancaster, Pennsylvania, and then went to Lebanon. In 1863 he became professor of theology at the Mercersburg Seminary, and occupied this chair until his death. He edited the *Mercersburg Review* during the last year of his life. His articles on religious topics were popular even among readers of other denominations. Among other things he published *The True Glory of Woman, and a Plea for the Lord's Portion of a Christian's Wealth* (1860); *The Golden Censer* (1860); *Hymns and Chants* (1861); and *Christological Theology* (1864). He died in Mercersburg, Pennsylvania, Dec. 28, 1867.

HARBOR GRACE, a port of Newfoundland, on the west side of Conception Bay, 84 miles by rail W. N. W. of St. John. Its harbor is spacious, though somewhat exposed, but the inner port is very secure. At the entrance of this stands a light-house with a revolving light. In commerce, this town is important, doing nearly a fourth of the business of the island. In population it is second only to St. John, having, in 1891, 6,466.

HARBORS AND DOCKS. This article is necessarily confined to the harbors of the United States, which are divided under the following heads: (1) The Atlantic Seaboard; (2) the Gulf Coast; (3) the Pacific Coast; and (4) the Lake Harbors:

(1) THE ATLANTIC SEABOARD. Calais, Maine, is the easternmost harbor of the United States; is the center of a considerable lumber trade; at Mark's Point, five miles from the town, there is a bar or ledge only eight feet deep at low water; but there is no anchorage in the harbor. Eastport, Maine, has a harbor free of ice in winter; there are two entrances to it, but they are not free from danger in stormy weather. Rockland, Maine, has an open harbor five fathoms deep within half a mile of the wharves and three fathoms to the wharves; but it is often closed by ice in winter. Winter Harbor, Maine, is in Frenchman's Bay, and one of the best on the east coast. Penobscot Bay can carry six to fourteen fathoms up to the town of Bucksport, where there is a good anchorage but a very strong current. Bangor, at the head of this bay, has an extensive lumber and ice trade; the bay is closed by ice during winter; and the harbor is defended by Fort Knox, at the narrows of the Penobscot. The harbor of Wiscasset, near Bath, Maine, can hardly be surpassed by any. Its depth is nine fathoms in the channel of the river. Bath has the largest ship-building and ship-owning interest in the state of Maine; is 12 miles up the Kennebec River, which has so strong a current that the ice can seldom close it up; and the entrance of the river is defended by Fort Popham. Portland, Maine, on a peninsula of the Casco Bay, has a harbor which can carry five fathoms to within half a mile of the wharves, and 10 feet up to the wharves. There are four entrances to the harbor, but only the most southern entrance can be used by large vessels. The harbor is defended by Forts Gorges, Preble, Scammel, and a battery on Portland Head. Portland has a large foreign and coasting trade, and is the principal shipping port for

Canada during the winter, as the harbor is always free of ice.

Portsmouth Harbor, New Hampshire, has a good anchorage, and six fathoms can be carried up to the city. A United States navy-yard is opposite Portsmouth, distant half a mile. For vessels not going up to the city or navy-yard the usual anchorage is at Pepperell's Cove, in from 6 to 11 fathoms. Portsmouth harbor is never closed by ice.

Newburyport Harbor, Massachusetts, has a bar with only six feet of water at low tide, but this obstruction is being removed. Rockport Harbor, Massachusetts, on the northern shore of Cape Ann, is eight fathoms deep to the wharf. It is the best harbor of refuge in that neighborhood. In Massachusetts Bay, between the headlands of Cape Ann and Cape Cod, there are several important harbors, those of Gloucester, Salem, Boston, Plymouth and Provincetown. Gloucester harbor has a good anchorage in five fathoms within 600 yards of the shore and in three and a half fathoms close to the shore; but it is frozen over in winter. Salem harbor can carry three and a half fathoms within half a mile of the town of Salem. The inner harbor is often closed by ice during January and February. Forts Lee, Pickering and Sewall defend this harbor. Boston harbor can carry 21 feet at any tide through the main channel. There are two other channels. It is defended by Forts Warren and Independence. The United States navy-yard is situated near Charlestown, opposite the city of Boston. Plymouth harbor is often frozen over, especially the inner harbor, and only 21 feet can be carried into the outer harbor. Provincetown has one of the finest harbors on the Atlantic coast. It has plenty of water, good holding ground, is easy of access, and, except during severe winters, is clear of ice. Sandwich harbor, in the southwestern part of Cape Cod Bay, is the proposed terminus to the ship-canal from Cape Cod Bay to the head of Buzzard's Bay; now it has a narrow and difficult entrance. New Bedford harbor can carry 16 feet into the inner harbor through a narrow, crooked channel. The outer harbor is an open roadstead with 4½ fathoms of water. There are forts at Clark's Point and Fort Point.

Newport, Rhode Island, has a fine harbor, with water enough for the largest ships; 19 feet can be carried into the inner harbor. Block Island Basin is an artificial harbor made by the United States government for the shelter of small vessels. It is 7 feet deep and protected by a solid stone breakwater. The United States Torpedo Station is located at Newport harbor. Fort Adams and some earthworks on Dutch Island defend it. The town of Bristol, Rhode Island, north of Newport, has a good anchorage in 5 fathoms of water, and off the lower end of the town the anchorage is 21 feet. Twenty-one feet can be carried through a dredged channel up to Providence.

New London Harbor, Connecticut, is on Long Island Sound. It is formed by the lower portion of the Thames River, and has a depth of 30 feet. Being 3 miles in length, it is one of the finest harbors in the United States. The entrance is defended by Forts Trumbull and Griswold. New Haven harbor is only 12 feet deep near the city, and even this depth is only found in a narrow channel. But 4 miles south of New Haven the water becomes 5 fathoms deep. The harbor is defended by Fort Hale. Long Island Sound is very free from dangers throughout its length, and affords many anchoring-places for light-draught coasters.

New York harbor is one of the finest and most capacious harbors of the world. It is entered from Long Island Sound through the East River; the Upper New York Bay is entered from the ocean through the Narrows, between Staten Island and Long Island. The East River forms a large part of the water-front of New York and Brooklyn, and for miles there are docks stretching along its shores. The East River channel was formerly obstructed by dangerous rocks and reefs at Hell Gate, both in mid-channel and projecting from the shores of small rocky islands; but these obstructions have been removed (see HELL GATE, in these Supplements), and a large foreign trade now takes this route. Eight miles below the Upper Bay is Lower New York Bay. It is in itself a harbor sufficiently large to accommodate all the

fleets of the world. The Hudson or North River forms also a large part of New York's water-front. The defenses of the harbor are Fort Schuyler on Throgg's Neck, at the western entrance of Long Island Sound, and a fort on Willet's Point on the opposite shore; Forts Wadsworth and Tompkins at the Narrows, and several detached batteries on the Staten Island shore; and Fort Hamilton and several batteries on the opposite Long Island shore. The forts in the bay are Fort Columbus, Castle William and some batteries, all on Governor's Island, and Fort Gibson on Ellis Island.

Perth Amboy, New Jersey, has a harbor with 11 feet of water up to the town; mean rise and fall of tide, 5½ feet. It seldom freezes over. Steamers can generally force their way through the ice when any is formed.

The harbor of Wilmington, Delaware, has only 12 feet of water, while the Delaware River has 20 feet up to near the city of Wilmington.

Hampton Roads, Virginia, is a channel between Chesapeake Bay and the estuary of the James River. It is defended by Fortress Monroe. This channel affords an excellent rendezvous for a fleet. There is plenty of water for vessels of any draught from the entrance of Chesapeake Bay, very near the fortress. Newport News is on the north, and Norfolk and Portsmouth are on the south side of this channel. The United States navy-yard is situated at Gosport, adjoining Portsmouth, and nearly opposite to Norfolk. Vessels drawing 21 feet of water can be carried to any of these cities. At Annapolis harbor, Maryland, vessels drawing 19½ feet of water can be carried over the bar. To the city of Baltimore, Maryland, 24 feet can be carried through a dredged channel, and 19 feet can be carried to the city of Washington, which is 200 miles from the ocean.

Newberne, North Carolina, is at the head of Pamlico Sound. Ten feet can be carried to the town, but only 8 feet over the bar from the sea into the sound. The same can be said about Plymouth, North Carolina, which is at the head of Albemarle Sound. Wilmington, North Carolina, is 30 miles above the mouth of the Cape Fear River. Eight feet can be carried over the outer bar at the mouth of the river, and 7 feet in the river channel to the city.

To Charleston harbor, South Carolina, 21 feet can be carried up the South Channel; but over the bar to the channel only 14 feet can be carried. Port Royal, South Carolina, at the head of Port Royal Sound, has a fine harbor with 21 feet of water over the bar. Brunswick, Georgia, has one of the best harbors on the coast. A deep arm of the sea, 20 miles long, leads to the town and approaches it by a channel 17 feet deep.

To Savannah, Georgia, 9 feet can be carried, while 17 feet can be carried over the bar at the mouth of the river. St. Mary's, Georgia, on St. Mary's River, has a good harbor. There are several anchorages inside the bar in from 4 to 7 fathoms of water. Seventeen feet can be carried to the town, 10 miles from the ocean.

To Jacksonville, Florida, on the St. John's River, 9 feet of water can be carried over the bar, through a narrow, crooked channel; it is 20 miles from the mouth of the river. St. Augustine has a shifting bar, with 10 feet of water, inside of which there is a good harbor north of the town, 18 to 20 feet deep.

(2) THE GULF COAST. Key West, southwest of the southern end of Florida, has a good anchorage for the largest vessels within a mile of the town. Three channels, the main ship channel, the southwest and the north-west channels, having from 12 to 30 feet of water, lead to this harbor. It is defended by Fort Taylor, some batteries and two Martello towers. The Dry Tortugas, a group of ten low islets west of Key West, form a large, deep and commodious harbor; it is of great strategic importance in the case of war with a foreign naval power, because it will afford its possessor an excellent base for naval operations. This splendid harbor is defended by Fort Jefferson, on Garden Key. Tampa Bay, Florida, is an estuary from 6 to 10 miles wide, and extending north-east for 20 miles, where it forms two arms. It affords anchorage in 5 fathoms of water. Cedar Keys, Florida, has three channels leading to the town. Sea-Horse Key is the deepest of these channels, with 9 feet of water on its bar. Cedar Keys is the terminus of the Florida railroad.

To Appalachicola, at the mouth of the river of the same name, 15 feet can be carried over the bar at the entrance of the bay; but only 4 feet can be carried to the town. St. Joseph's Bay is a large, deep and commodious harbor, just north of Cape San Blas; it can be entered in a gale or hurricane, and affords excellent anchorage. Pensacola Bay, Florida, is protected by Santa Rosa Island, and has an entrance 20 feet deep. It is defended by Forts Pickens, McRee and Barrancas, besides a redoubt on the north side. The city of Pensacola is 10 miles from the entrance, and the United States navy-yard is within three miles of the city.

Mobile Bay, Alabama, is an estuary 30 miles long. The Mobile River, a large navigable stream, flows into this bay. The bay's entrance, between Fort Morgan and Dauphin Island, is nearly three miles wide. Eighteen feet can be carried through a dredged channel 21 miles long to the city of Mobile.

New Orleans, Louisiana, is 120 miles from the sea. The Mississippi River surrounds the city on three sides. Where the river flows into the Gulf of Mexico it spreads out into four prongs, called the Southwest, Southeast, Northeast and South Passes; the famous jetties of Captain James B. Eads are at the entrance of the South Pass; it is 26 feet deep and 300 feet wide, while the other three passes are only from 7 to 15 feet deep. The Mississippi delta and the neighboring waters are defended by the following works: Forts Pike, Macomb, Livingston, Jackson and Philip, Tower Dupré, Battery Bienvenue and the Tower at Proctersville.

To Galveston harbor, Texas, 11 feet can be carried over the outer bar and  $9\frac{1}{2}$  feet to the city wharves. Appropriations have been made for deepening the entrance. It is defended at Fort Point and Bolivar Point.

(3) THE PACIFIC COAST. Port Townsend, Washington, on the Strait of Juan de Fuca, has a fine harbor, and 5 to 9 fathoms can be carried within 400 yards of the town. Up to the wharves of Seattle, on Puget Sound, 5 fathoms can be carried, and there is plenty of water at the anchorage off the town.

Astoria, Oregon, at the mouth of the Columbia River, has usually over 28 feet of water from the bar to the town, but the depth of the bar varies.

Crescent City, California, has a very dangerous harbor, with many shoals and rocks. San Francisco has one of the finest harbors in the world. Twenty-three feet can be carried over the bar to the city and in almost any part of the bay, which is connected with the ocean by a strait called the Golden Gate. The entrance of the harbor is defended by Fort Point, on the south shore of the Golden Gate, and another fort has been constructed on Alcatraz Island, two miles north of the city. Vallejo is situated 27 miles north of San Francisco Bay, on the opposite side of Napa Creek from the United States navy-yard. To the anchorage between the town and the navy-yard 21 feet of water can be carried at low tide. Santa Cruz, California, has a well-protected harbor, with good anchorage in water from  $3\frac{1}{2}$  to 15 fathoms deep. Santa Barbara, California, has a harbor open on the south side, but partially protected by an island. It is 19 feet deep at the wharves. The harbor of San Diego is formed by a projecting point of land on the west side, which terminates at the south end in Point Loma and on the east side by a flat peninsula. The entrance to this fine harbor is over a bar with 21 feet of water.

(4) LAKE HARBORS. Duluth, Minnesota, has a dredged basin 17 to 20 feet deep, covering a very extensive area. Grand Marais, Minnesota, has a similar basin, protected by a breakwater. Ontonagon harbor, Michigan, is shallow at the mouth of the river; but piers have been built from the shore into the lake, and the bottom between these piers has been dredged until a depth of 12 feet was secured. Oconto, Wisconsin, lies on Green Bay. Its harbor has also been deepened by dredging between two piers. Green Bay harbor has a dredged channel 14 feet deep to the deep water of Green Bay. Sturgeon Bay, Wisconsin, has a harbor of refuge between two piers one quarter mile in length. Its channel is 16 feet deep. Sheboygan Harbor, Wisconsin, is approached by a channel from 14 to 18 feet deep. Milwaukee Bay, Wisconsin, has an artificial harbor of refuge formed by inclosing a portion of Lake

Michigan within an outlet breakwater of crib-work. Milwaukee harbor has a channel 18 feet deep between two piers. Racine harbor, Wisconsin, has a dredged channel 13 feet deep between piers.

Chicago has an outer harbor, adjoining the Chicago River, of a depth of 16 feet, and a harbor of refuge, which affords good anchorage in deep water and safe access to the river and harbor. Calumet harbor has a dredged channel, 300 feet wide and 16 feet deep, from Lake Michigan to the Calumet River. Michigan City has an outer and an inner harbor. The inner harbor has been deepened at shoal points to 17 feet, and the heaviest vessels can now pass to any part of it. The harbor of Cheboygan, Michigan, has a depth of 15 feet in the basin opposite the steamboat-landing, and a 15-foot channel to the Strait of Mackinac. The width is only from 90 to 100 feet in some parts.

The harbor of refuge at Belle River, Michigan, has a channel 50 feet wide and 12 to 13 feet deep. It affords a safe refuge against running ice. Monroe Harbor, Michigan, has a channel 10 feet deep between the Raisin River and Lake Erie, the entrance into the lake being protected by piers. Toledo harbor is approached by a channel dredged through Maumee Bay. It is from 15 to 17 feet deep at low water. Sandusky City harbor has a channel 150 feet wide and 14 feet deep, by which it is approached through the outer bar. Huron harbor is approached between parallel lines of piers running out into Lake Erie. They give a wide entrance of at least 14 feet depth.

Cleveland harbor has now a good, wide channel, where the Cuyahoga River empties into Lake Erie, with a depth of from 17 to 20 feet between the railroad bridge and the lake. Fairport harbor, at the mouth of the Grand River, is approached between parallel piers 200 feet apart, leaving a channel 16 feet deep between them. Ashtabula is approached in a similar way. Erie harbor has a channel of 16 feet depth from the lake to the harbor. Dunkirk harbor has been formed by a breakwater nearly parallel to the shore. The channel is 13 feet deep between ragged rocks on either side. Buffalo harbor is made by a breakwater of crib-work  $1\frac{1}{4}$  miles long, running parallel with the shore, and a line of pile and cribwork three fourths mile long running out toward the southern end of the main breakwater. They leave an open space of about 150 feet width between themselves.

Charlotte Harbor, New York, has a channel of 15 feet depth into Lake Ontario. It is the harbor for the city of Rochester, New York. Greatodus has a harbor formed of two breakwaters meeting at an angle. From the opening, parallel piers extend into the lake, the channel between them having now a depth of 10 feet. Oswego harbor, New York, is made by two breakwaters, one a mile in length and the other half a mile. The mouth of the Oswego River has been deepened to 15 feet. The harbor of Sackett's Harbor, New York, was formed by dredging an area of 15 acres to a depth of 12 feet. Ogdensburg harbor, New York, was made by deepening the channel along the St. Lawrence River front to 12 and 14 feet, and dredging a channel 15 feet deep, which leads to the deep water of the St. Lawrence.

Docks are divided into wet docks, dry docks and floating docks. For the description of the wet and dry docks, see Vol. XI, p. 465.

"Floating sectional dry-docks" consist of several sections joined together by sliding beams. Each section consists of a large rectangular tank, at the sides of which are frames formed of four uprights. In each of these frames a float moves up and down in suitable gearings. It rises when a section is being lowered, and goes down when a tank is being raised.

In the "tubular floating-docks," both the bottom and vertical sides consist of large wrought-iron tubes. The bottom consists of eight such tubes running longitudinally; and the sides consist of many similar tubes fixed vertically inside of the two outer longitudinal tubes. The tubes are divided into many water-tight compartments, and have water-valves at the bottom. When the dock is to be sunk, these valves are opened. When it is to be raised, compressed air is forced into the tubes, and the water is thus expelled through the valves. As soon as the dock and its vessel are fully raised, the bottom valves are closed again.

By the "hydraulic lift-dock" the vessel is lifted bodily out of the water upon a raft-like pontoon, which has sufficient buoyancy to sustain the weight of the vessel. For this purpose the pontoon is brought up between two rows of columns extending down to the dock below. These columns carry hydraulic lifts. From the heads of these lifts some rods extend and are made fast to lattice girders reaching across to the opposite column. Upon these girders the pontoon rests. When the pontoon is raised the water is let out by valves in the bottom of its tubes. As soon as the ship is lifted it may be floated away on its own pontoon, and the dock is left free to be used on another pontoon to raise a second ship.

A "balance floating-dock" consists of a large rectangular tank having hollow walls along its two long sides, but no walls at the ends. It is divided into a number of compartments. By pumping water into these side chambers any part of the dock may be lowered; and by forcing compressed air into them and the water out of them, they may be raised. Thus the dock can be balanced at any desired level.

1869 he was appointed Whewell professor of international law at Cambridge, from which he retired, in 1873, on becoming solicitor-general in the Gladstone administration. In the latter year he was knighted. In Mr. Gladstone's second ministry (1880-85) Sir William was appointed Home Secretary, and in that capacity introduced in Parliament the Prevention of Crimes Bill, of 1882, and the Explosives Bill, of the following year, which dealt summarily with the dynamite outrages of the period. He was also a vigorous defender of Mr. Gladstone's Irish Home Rule measure, which was defeated in 1893. During and since this period he has sat in the House of Commons as member for Derby. He went out of office with his party in June, 1885, but on the return of the Liberals to power, Feb. to July, 1886,

#### DRY DOCKS IN THE UNITED STATES OF MORE THAN FIFTY-EIGHT FEET BREADTH.

PORTS.	LENGTH OVER ALL.	WIDTH OF ENTRANCE AT TOP.	DEPTH OVER SILL AT HIGH-WATER SPRING-TIDES.	KIND OF DOCK.	MATERIAL.	LOCATION.
Buffalo.....	350	60	10	Basin.		
Detroit.....	308	65	13	Basin.		} Foot Orleans Street.
Detroit.....	360	75	11.5	Basin.		
Albina, Oregon.....	400	72	28	Basin.		
San Francisco.....	210	60	20	Floating.	Wood.	
San Francisco.....	450	90	24	Basin.	Stone.	Hunter's Point.
San Francisco.....	529	78	26.5	Basin.	Stone.	Navy Yard.
Portland, Maine.....	425	80	24	Basin.	Wood.	
Portsmouth, N. Hampshire.....	350	90	23	Floating.	Wood.	Navy Yard.
Boston.....	379	60	25	Basin.	Stone.	
Boston.....	365	64	17.5	Basin.	Wood.	East Boston.
New York.....	330	90	18.5	Balance.	Wood.	Foot Rutgers Street.
New York.....	360	100	20	Sectional.	Wood.	} Between Pike and Clinton Sts.
New York.....	250	75	16	Sectional.	Wood.	
New York.....	170	65	16	Sectional.	Wood.	
Brooklyn.....	350	66	25	Basin.	Stone.	Navy Yard.
Brooklyn.....	540	100	22	Basin.	Wood.	} Eric Basin.
Brooklyn.....	630	85	25	Basin.	Wood.	
Jersey City.....	185	62	14	Balance.	Wood.	
Philadelphia.....	434	70	21.5	Basin.	Wood.	Cramp's Shipyard.
Philadelphia.....	200	62	14	Sectional.	Wood.	
Baltimore.....	504	80	23	Basin.	Wood.	} Locust Point.
Baltimore.....	220	67	14	Floating.	Wood.	
Norfolk.....	320	60	-----	Basin.	Stone.	
New Orleans.....	315	90	16	Floating.	Wood.	
New Orleans.....	220	75	14	Floating.	Wood.	
New Orleans.....	225	75	16	Floating.	Wood.	

HARBOR SPRINGS, a village and the capital of Emmet County, northern South Michigan, on the north coast of Little Traverse Bay, the terminus of a branch of the Grand Rapids and Indiana railroad. It has a very good harbor, from which is shipped farm produce, lumber and fish. It is a summer resort. Population 1890, 1,052; 1900, 1,643.

HARCOURT, SIR WILLIAM GEORGE GRANVILLE VENABLES VERNON, an English Liberal leader, was born at Nuneham Park, Oxford, Oct. 14, 1827. He is the son of the late Rev. W. V. Harcourt, and grandson of a former archbishop of York. After his public school education he entered Trinity College, Cambridge, where he graduated with high honors in 1851. Called to the bar in 1854, he was made Queen's Counsel in 1866, and two years afterward entered Parliament for the city of Oxford in the Liberal interest. In

was Chancellor of the Exchequer; an office which he filled also in 1892-95. On Lord Rosebery's accession to the premiership in March, 1895, he became leader of the Liberal party in the House of Commons, but resigned that position on Dec. 8, 1898.

Next to his chief, Mr. Gladstone, he was one of the ablest and most vigorous speakers on the platform and in Parliament, was an able and effective debater, and had an intimate knowledge of public affairs. He was, moreover, versed in economical and financial subjects, and in 1894, as Chancellor of the Exchequer, introduced in Parliament a radical and almost revolutionary budget, which created a sensation in political circles by its plan of graduated death duties, and its imposts upon foreign and colonial investments.

Sir William Harcourt was one of the original contributors to the London *Saturday Review*, under the editorship of Mr. Douglas Cook. Early in

the sixties he was also a contributor to the *London Times*, and for that journal wrote a series of notable letters on international law, under the pen-name of "Historicus." These letters appeared in 1863 in a collected volume. Sir William, in 1876, married, as his second wife, Mrs. Ives, a daughter of the historian, John Lothrop Motley.



SIR WILLIAM HARCOURT.

HARDÉE, WILLIAM J., an American soldier; born at Savannah, Georgia, Oct. 10, 1815. He graduated at West Point, 1838, and, after serving in Florida for a time as first lieutenant of Second Dragoons, was sent by the Secretary of War to the Military School of St. Maur, France, where he was attached to the cavalry; after his return, was made captain of dragoons. In 1847 he was promoted major for gallantry at the siege of Monterey, and at the close of the war was brevetted lieutenant-colonel. From 1856 to 1861 he was at West Point as commandant of cadets, and then joined the Confederate army with the rank of colonel. He served with distinction during the war, and attained the rank of lieutenant-general. At the close of the war he retired to his plantation in Alabama. Before going to West Point he was called upon by Jefferson Davis, then Secretary of War, to compile what has since been commonly known as *Hardée's Tactics*, adopted for use in the United States army and militia. He died in Wytheville, Virginia, Nov. 6, 1873.

HARDING, CHESTER, an American portrait-painter and artist; born in Conway, Massachusetts, Sept. 1, 1792. He became a house-painter, and later devoted himself to portrait-painting. After studying in Philadelphia he established himself in St. Louis; he also studied three years in London, and in 1826 settled in Boston, where he became very popular. Among the distinguished personages who sat to him were James Monroe, James Madison, John Quincy Adams, John Marshall, William Wirt, Henry Clay, John C. Calhoun, Washington Allston, the dukes of Norfolk, Hamilton and Sussex, Daniel Webster and W. T. Sherman. He wrote *My Egotistography*. Died in Boston, April 1, 1866.

HARDING, SIR ROBERT PALMER, an English lawyer; born in 1821. He commenced his law practice in 1847, and has since taken part in many important liquidation cases, including the celebrated case of Overend, Gurney and Company, in which the liabilities amounted to nearly twenty million pounds sterling. In 1864 he was appointed a commissioner to inquire into the working of the Bankruptcy Act, and in 1883 he reorganized this department on the basis of the Bankruptcy Act of 1883. In January, 1890, he was knighted, and later was appointed a director in Imperial British East Africa Company.

HARDWICKE. THE FAMILY OF YORKE, EARLS OF. The founder of the family was PHILIP YORKE; born at Dover, England, Dec. 1, 1690, the son of a petty tradesman. Under the patronage of Chief Justice Macclesfield he was admitted to the bar (1715), and elected to the House of Commons (1719). Lord Macclesfield becoming Lord High Chancellor (1720), he was made Solicitor-General and Attorney-General (1724), when he had to prosecute his patron, Lord Macclesfield, for malfeasance in office. He was made Lord Chief Justice and a peer in 1733, and Lord High Chancellor in 1737. His legal learning and conservatism were considered of the highest order, and his decisions were never reversed on appeal. In Atkyns and Vesey's *Reports* are to be found many of his decisions. In the matter of common-law marriage his views are, in most respects, adopted by jurists of the present day in England and America. (See MARRIAGE, Vol. XV, p. 567.) Created Earl of Hardwicke in 1754, and died in London, March 6, 1764.—PHILIP, second earl; born Dec. 9, 1720; was distinguished as a man of letters; graduated from Cambridge; in 1762 was elected Chancellor of the University; was Member of Parliament from 1741 to 1764, but his feeble health prevented him from taking an active part in politics. He devoted most of his time to literature; wrote for *Athenian Letters*, author of *Walpoleana*, etc. Died May 16, 1790.—PHILIP, third earl; born about 1757; governor of Ireland as Lord-Lieutenant, 1801-05; fellow of Royal Society; died in 1834.—CHARLES PHILIP, fourth earl; born in 1799; educated at Harrow and the Royal Naval College; member of the House of Commons, 1831-34; inherited the title in 1834; captain of the *Vengeance* in 1848; by his energetic attitude quelled the republican revolution in Genoa against King Charles Albert of Sardinia; made rear-admiral in 1854; Lord of Privy Seal in Cabinet of Lord Derby, 1858-59. Died in 1873.—CHARLES PHILIP, fifth earl; born April 23, 1836; succeeded to the peerage in 1873.

HARDY, ARTHUR SHERBURNE, an American educator and author; born in Andover, Massachusetts, Aug. 13, 1847; graduated at West Point, 1869. Entered the United States Army as second lieutenant, but resigned the following year and became professor of civil engineering and applied mathematics in Iowa College, Grinnell, 1870; after studying one year in the *École des Ponts et Chaussées*, Paris, he became professor in Chandler Scientific School of Dartmouth, and in 1878 professor of mathematics in the college proper. He is the author of *Elements of Quaternions* (1881); *Imaginary Quantities* (1881); *New Methods in Topographical Surveying* (1884); a poem entitled *Francesca of Rimini*, and the following novels: *But Yet a Woman* (1883); *The Wind of Destiny* (1886); and *Passe Rose* (1889); published also the *Life and Letters of Joseph H. Nessima*. Appointed Minister to Persia in 1897.

HARDY, IZA DUFFUS, an English author; a daughter of Sir Thomas Duffus Hardy (1804-78),

keeper of the Royal Records; began writing stories for publication at a very early age. Among her more important novels are *A New Othello* (1890); *Glencairn*; *Only a Love Story*; *A Broken Faith*; and her three American tales: *Hearts and Diamonds*; *The Love That He Passed By*; and *Love in Idleness*. She wrote two volumes of American Reminiscences. In 1893 she published *A Woman's Loyalty*.

HARDY, ROBERT SPENCE, an English author; born at Preston, England, July 1, 1803; was ordained a Wesleyan minister (1825); spent twenty-three years in Ceylon as a missionary, where he was one of the earliest students of Buddhism and considered the best scholar of his day in the Páli language. He returned to England in 1848. He wrote *The British Government and the Idolatry of Ceylon* (1841); *Eastern Monachism* (1850); *A Manual of Buddhism in its Modern Developments* (translated from Singhalese MSS., 1853); *Legends and Theories of the Buddhists Compared with History and Science* (1867). Died at Headingley, Yorkshire, April 16, 1868.

HARDY, THOMAS, English novelist; was born in Dorsetshire, England, June 2, 1840, and educated partly at King's



THOMAS HARDY.

College, London, and partly by private tutors. In 1858 he was articled to an architect, and, like Mr. Hall Caine, his fellow-novelist, he for a time equipped himself for the duties of that profession, gaining, in 1863, some notable prizes and medals for architectural design drawing. Some years later, however, he took to literature, and in 1871 published his first novel, *Desperate Remedies*, which was followed in 1872 by *Under the Greenwood Tree*, in 1873 by *A Pair of Blue Eyes*, and in 1874 by perhaps the best of his early works of fiction, *Far from the Madding Crowd*. This latter novel, which appeared in the *Cornhill Magazine*, and was afterward successfully dramatized, deals with Dorsetshire peasant-life, and shows much skill in its handling, with a fine eye for natural beauties, and great power in the portrayal of rustic character. Other novels from his pen are *The Hand of Ethelberta* (1876); *The Return of the Native* (1878); *The Trumpet-Major* (1880); *A Laodicean* (1881); *Two on a Tower* (1882); *The Mayor of Casterbridge* (1882); *The Woodlanders* (1886); and *Wessex Tales* (1888). With *A Group of Noble Dames* and *Tess of the d'Urbervilles* (1891), Mr. Hardy, who had been making good his claim to rank with the foremost novelists of the time, gave a shock to some of his readers by joining the realistic school of fiction and portraying in his tales objectionable types of character, introducing risqué situations and unsavory scenes in the social annals and tragedies of his favorite Wessex families. The natural result followed in an increase of popularity and an outcropping of discussion,

adverse and friendly, on the true function of the novelist, which have since been augmented by the publication of *Life's Little Ironies* (1894); *Jude the Obscure* and *The Pursuit of the Well-Beloved* (1895). In 1893 Mr. Hardy wrote a successful drama, *The Three Wayfarers*, based on his Wessex tales. As an evidence of Mr. Hardy's fame, it may be added, that more than one monograph on him and his novels have appeared, the best, however, being that of Mr. Lionel Johnson, entitled *The Art of Thomas Hardy* (1893), with an etched portrait and bibliography.

HARDY, SIR THOMAS DUFFUS, a British author; born in 1804, at Port Royal, Jamaica. At the age of 15 he became a junior clerk in the Tower of London, was made deputy-keeper of the public records in 1861, and knighted in 1870. He won great distinction by his compilation of the *Monumenta Historica Britannica*, intrusted to him by the government, and for which he wrote a valuable introduction. Among his important works are two folio volumes of the early *Close Rolls* (1833-44); one of the *Patent Rolls* (1835); and others of the *Norman Rolls* and *Charter Rolls*; *William of Malmesbury* (1840); a *Descriptive Catalogue of MSS.* relating to the history of Great Britain and Ireland (1862-71); and other works of much historical value. Died in London, June 15, 1878.

HARE, GEORGE EMLEN, an American clergyman and a nephew of Robert Hare, the scientist; born at Philadelphia, Sept. 4, 1808; graduated from Union (1826); rector of the Protestant Episcopal Church of St. John, Carlisle, Pennsylvania (1830); then rector of Trinity Church, Princeton, New Jersey (1834); assistant professor of Latin and Greek at the University of Pennsylvania (1844, 1845); rector of St. Matthew's, Philadelphia, and of the Protestant Episcopal Academy; practically the founder of the Philadelphia Protestant Episcopal Seminary, where he was professor for twenty-five years. Died in Philadelphia, Feb. 15, 1892.—His son, WILLIAM HOBART, an American Protestant Episcopal bishop, born in Princeton, New Jersey, May 17, 1838; was ordained deacon in 1859, and priest in 1862. In 1864 he was elected rector of the Church of the Ascension in Philadelphia; next became general agent of the foreign committee of the Board of Missions, and in 1872 was elected Missionary Bishop of Niobrara. His jurisdiction in 1883 was extended over the southern part of Dakota, the incumbent being now called Missionary Bishop of South Dakota. Was sued for slander by a priest he had deposed for cause. After losing the case in the lower court the bishop was fully vindicated by the appellate judges.

HARE, JOHN INNES CLARK, an American jurist, and the son of the scientist, Robert Hare; born in Philadelphia, Pennsylvania, Oct. 17, 1817; graduated from the University of Pennsylvania, 1834; admitted to the bar, 1841; became associate judge of the district court, 1851; presiding judge, 1867; presiding judge of the

court of common pleas, 1875. A lawyer of wide learning and clear comprehension of facts. Published *American Leading Cases in Law* (2 vols.; with H. B. Wallace, 1847); *Smith's Leading Cases in Law* (2 vols.; 1852); *White and Tudor's Leading Cases in Equity* (3 vols.; 1852); *Hare on Contracts* (1887).

HARE, ROBERT, an American scientist; born in Philadelphia, Pennsylvania, Jan. 17, 1781; son of an English brewer. He early showed an interest in chemistry and physics, and before he was twenty was a member of the Chemical Society of Philadelphia. In 1801 he invented the oxy-hydrogen blowpipe; shortly afterward he contrived an apparatus which was the first to render lime, magnesium, iridium and platinum fusible in any considerable quantity; from this discovery proceed what are commonly known as the Drummond or calcium lights. In 1816 he invented the calorimotor, a heat-producing battery; it was the basis of his discovery of the application of voltaic electricity to blasting under water (1831). His chemical "finds" were also many and valuable. In 1818 he became professor of chemistry in William and Mary College, and also accepted a similar position in the medical department of the University of Pennsylvania. He resigned the latter position in 1847. Later he became a believer in spiritualism, and lectured in its advocacy. He made numerous contributions to scientific literature, over two hundred papers in the *American Journal of Science*, and published *Brief View of the Policy and Resources of the United States* (1810); *Chemical Apparatus and Manipulations* (1839); *Compendium of the Course of Chemical Instruction in the Medical Department of the University of Pennsylvania* (1840); *Memoir on the Explosiveness of Nitre* (1850); and *Spiritualism Scientifically Demonstrated* (1855). All his ingenious apparatus, many of them unique in conception and construction, he bestowed by will to the Smithsonian Institution. He died in Philadelphia, May 15, 1858.

HARELD, a duck of the genus *Harelda*, common on the sea-coasts of the northern hemisphere. The bird is often known as the long-tailed duck, also as "old-wife" or "old-squaw."

HARE-LIP. See ANATOMY, Vol. I, p. 831.

HARGRAVE, ROBERT KENNON, a Methodist Episcopal bishop; born in Pickens County, Alabama, September 17, 1829; graduated from the University of Alabama (1852); professor of pure mathematics there (1853-57); entered the Methodist Episcopal ministry (1858); president of the Centenary Institute of Alabama (1867); president of Tennessee Female College (1868-73); bishop of the Methodist Episcopal Church (1882); president of the board of trustees of the Vanderbilt University (1889); saved the publishing-house of the Methodist Episcopal Church South from bankruptcy by his wise management; was a member of the commission of 1868, organized to establish friendly relations between the North and South branches of the Methodist Episcopal Church.

HARGRAVES, EDMUND HAMMOND, an English prospector, the discoverer of the gold-fields of Australia, born at Gosport, England, about 1815; a sailor from boyhood, he saw much of the world, and at the age of 18 settled in Australia; in 1849 he was attracted to California, where he tried his luck as a gold-digger. While thus engaged he was greatly struck by the similarity in the geological formation of California and Australia, and on his return home he entered upon explorations which resulted in the discovery of valuable gold-fields in the Bathurst district, Australia, April 30, 1851. Within a year the export of Australian gold reached \$20,000,000. He was appointed commissioner of crown lands, and received from the government of New South Wales a reward of \$50,000. In 1855, one year after his return to England, he published *Australia and Its Gold-Fields*. He died Oct. 1, 1891.

HARICOT. See BEAN, Vol. III, p. 460.

HARKNESS, ALBERT, an American educator; born in Mendon, Massachusetts, Oct. 6, 1822; graduated from Brown University (1842); taught in the Providence High School (1843-53); spent two years in German universities; professor of the Greek language and literature in Brown (1855). The text-books prepared by him are very extensively used; the leading ones are *First and Second Latin Books* (1851-53); *First Greek Book* (1860; revised 1885); *Latin Grammar* (1864; revised 1874 and 1881); *Latin Reader* (1865); *Latin Composition* (1868); *Complete Latin Course for the First Year* (1883), and his school editions of *Cæsar*, *Cicero* and *Sallust*.

HARKNESS, WILLIAM, an American astronomer, and the son of James Harkness, the Scotch-American Presbyterian divine; born in Ecclefechan, Scotland, Dec. 17, 1837; graduated from the University of Rochester, New York (1858); M. D. (1862); aide to the United States Naval Observatory (1862); joined the army as surgeon just before the second battle of Bull Run; professor of mathematics in the United States Navy (1863); on board the *Monadnock*, during a cruise in South American waters and around Cape Horn, he made exhaustive observations on terrestrial magnetism; the Smithsonian Institution published his notes. From 1868 to 1874 he was attached to the United States Naval Observatory; discovered the 1474th line of the solar corona during the total eclipse of Aug. 7, 1869; as member of the United States Commission to observe the transit of Venus, he visited Hobart Town, Australia (1874); he planned similar expeditions organized since, and invented the machine used to measure astronomical photographs.

HARLAN, a town and the capital of Shelby County, southwestern Iowa; on the Nishnabtna River, and the terminus of a branch of the Chicago, Rock Island and Pacific railroad. It is the trading center of a rich agricultural region, and has manufactories of plows, flour and iron castings. Population 1890, 1,765; 1900, 2,422.

HARLAN, JAMES, an American statesman; born in Clarke County, Illinois, Aug. 25, 1820;

graduated at Indiana Asbury University (1845); superintendent of public instruction for Iowa (1847); president of Iowa Wesleyan University (1853). He sat in the United States Senate as a Whig from 1855 to 1857; was disqualified on a technicality, but reëlected the same year, and again in 1861, when he was a delegate to the Peace Convention. In 1865 he resigned to become Secretary of the Interior; was again elected to the Senate in 1866, and served from March, 1867, to March, 1873. In 1869 he was appointed president of the Iowa University. From 1882 to 1885 he was presiding judge of the court of commissioners of Alabama claims.

HARLAN, JOHN MARSHALL, an American jurist, and son of James Marshall, some time Secretary of State and Attorney-General of Kentucky; born in Boyle County, Kentucky, June 1, 1833; graduated at Centre College, 1850; called to the bar 1853; judge of Franklin County, Kentucky, 1858; he was in the volunteer Union service during the war; was attorney-general of his state 1863-67, and an unsuccessful candidate for governor in 1871 and 1875. On Nov. 29, 1877, he was appointed by President Hayes associate justice of the United States supreme court, and in 1892 one of the arbitrators on the part of the United States before the Bering Sea tribunal.

HARLAND, MARION, pseudonym of TERHUNE, MRS. MARY V. H., q.v. in these Supplements.

HARLEIAN COLLECTION. Manuscripts preserved as a part of the treasures in the British Museum, London, and gathered by Robert Harley, first Earl of Oxford, 1661-1724, and his son. It consists of early civil and ecclesiastical records, manuscripts of ancient classics, illuminated missals and poems, essays, plays, etc., in almost every modern language. There are about 7,600 volumes and 14,000 original rolls, charters and deeds. It was purchased for £10,000 by the British Government just before the death of its collector. See OXFORD, EARL OF, Vol. XVIII, p. 100. The Harleian Society publishes, at stated intervals, reproductions of some of the most important manuscripts of this collection, in its *Harleian Miscellany*. See also BRITISH MUSEUM in these Supplements.

HARLEM RIVER. See NEW YORK, Vol. XVII, p. 457.

HARLEQUIN. See PANTOMINE, Vol. XVIII, pp. 215, 216.

HARLEQUIN DUCK. A duck of the genus *Histrionicus*, found near sea-coasts of northern Europe-Asia and North America. It migrates southward during the winter. The bird is lead-blue in color with irregular white marks; the male with a white collar.

HARLEY, GEORGE, a Scotch physician; born at Haddington, East Lothian, Scotland, 1829; graduated as M.D. from Edinburgh University, 1850; studied for five years in the leading medical schools of the continent; lecturer on practical physiology and histology at University College, London; professor of medical jurisprudence,

1860; physician to the University College Hospital, 1861; in 1863 he received the triennial prize of the Royal College of Surgeons, for his *Essay on the Suprarenal Bodies*; he wrote *Histology, healthy and morbid, on Diabetes; Albuminuria; Jaundice; Kidney Derangements; Liver Diseases* (1,200 pages.) He has advocated strongly a reform of spelling, and wrote *Simplification of the English Spelling* (1877), and *A Conservative Scheme for National Spelling Reform* (1878). He died in London, Oct. 23, 1896.

HARLEY, ROBERT, an English clergyman and mathematician; born in Liverpool, Jan. 28, 1828; when 16 years old he was appointed mathematical master at Seacombe School, and at 17 assistant head-master at Blackburn School, where he had been educated; in 1846 he started his famous correspondence on algebraic investigations with Sir James Cockle, Chief Justice of Queensland, Australia; educated for the ministry at Airedale College, Bradford; ordained pastor of the Congregational Church of Brighouse, Yorkshire, 1854-68, when he accepted a charge in Leicester; appointed vice-master of Mill Hill School (1872); principal of Huddesfield College (1882); finally devoted all his time to mathematical researches; although a nonconformist, was elected, at 35, a Fellow of the Royal Society; author of numerous papers on pure mathematics, *Inter Alia: On the Method of Symmetric Products; The Theory of Quintics; Differential Resolvents; The Theory of the Transcendental Solution of Algebraic Equations; The Explicit Form of the Complete Cubic Differential Resolvents; The Umbral Notation*.

HARMALINE, a vegetable alkaloid derived from the husks of the seeds of *Peganum Harmala*, or Syrian rue, a zygophyllaceous shrubby plant that grows abundantly in the steppes of southern Russia. The seeds have been used in dyeing silk, to which they impart various shades of red.

HARMAN, HENRY MARTYN, an American instructor; born in Maryland, March 22, 1822; graduated from Dickinson College, Carlisle, Pennsylvania (1848); professor in Baltimore Female College (1853-55); principal of Baltimore Classical Institute (1858-68); professor of the ancient languages at Dickinson College (1870-79), when he was appointed there professor of Greek and Hebrew; wrote *A Journey to Egypt and the Holy Land* (1872); *Introduction to the Study of the Holy Scriptures* (1878); and was a contributor to the leading periodicals in his line of study.

HARMAR, JOSIAH, an American soldier; born in Philadelphia, Pennsylvania, in 1753; educated at Robert Prout's Quaker School; entered the Continental army in the First Pennsylvania Regiment (1776); lieutenant-colonel (1777); was in Washington's army (1778-80), and in General Greene's corps, in the South (1781-82); brevet-colonel (1783); brought to France the ratification of the final treaty (1784); was present as Indian agent at the treaty with the Indians at Fort McIntosh (1785); brevetted by Congress brigadier-general (1787); general-in-chief of the United States army (1789); commanded an expedition



against the Miami Indians (1790); resigned (1792); adjutant-general of Pennsylvania (1793-96). Died in Philadelphia, Aug. 20, 1813.

HARMATTAN. See SIERRA LEONE, Vol. XXII, p. 44.

HARMONIC MOTION. See MECHANICS, Vol. XV, pp. 686-691.

HARMONIC RATIO. See HARMONIC ANALYSIS, Vol. XI, pp. 481, 482.

HARMONICS. See MUSIC, Vol. XVII, pp. 88, 89.

HARMONISTS, members of a religious community, of communistic character, organized by George Rapp (1770-1847), a German of Würtemberg. Disturbed by the authorities, they removed in 1803 to Butler County, Pennsylvania, and formed a settlement which they called Harmony. In 1815 they removed to New Harmony, Indiana, but returned to Pennsylvania ten years later, and formed the township of Economy, a few miles from Pittsburg, where they own thirty-five hundred acres of land and carry on important manufactures. They hold all property in common, do not marry, lead blameless lives, and believe in an early second coming of Christ. They make hardly any proselytes and the community is not more than 250 strong (1890). Their very valuable estate will finally become the property of the last survivor.

HARMONY, MUSICAL. See ACOUSTICS, Vol. I, pp. 107-110.

HARMONY OF THE GOSPELS. To write a life of Jesus is a task of more than ordinary difficulty. Research has found no material beyond what is supplied by the canonical books of the New Testament. Before the canon was formed there was opportunity to gather traditions and weave them into a free story, but the oldest extant book of that sort has no larger foundation than the four gospels. Tatian (see Vol. XXIII, pp. 80-82) was in many respects qualified for the task, and his *Diatessaron* was written scarcely more than 140 years from the crucifixion. Yet that work was known to scholars chiefly through the references made to it by Eusebius and Ephraem Syrus, who made a commentary upon it, until the labors of Zahn gave the world a restored text in 1881. The principal worth of Tatian's *Diatessaron* is in its support of the canonical gospels as the sources of authentic information concerning our Lord. He has no other authorities, and he particularly upholds the fourth gospel as to time and genuineness.

For many centuries the conception that the oldest documents received by the Christian church could be harmonized into a corroborative account of Jesus was a favorite theme. Yet, strangely enough, the literature on this subject is scant. Questions have arisen as to which of the evangelists was nearest to the original tradition, or, in other words, was most historical. The earliest writers were not conspicuous for a critical understanding, in the modern sense, and yet they were far from being heedless. Theophilus of Antioch, late in the second century, tried to fit together

the four gospels in one concurrent narrative. In the next century Ammonius of Alexandria made a *Diatessaron* or four-gospels harmony, in which St. Matthew served for a basis of chronology. From this work Eusebius of Cæsarea constructed his *Sections and Canons*, a work with the gospels arranged in parallel passages, and of which the last results of research may be found in Dr. Abbott's article on the GOSPELS, Vol. X, pp. 789-843. This work of Dr. Abbott's, while using the parallelisms of the evangelists, does not aim at harmony, but is a critical effort to exhibit the original tradition of Jesus as current among the first generation of Christians, in which the historic facts are of first importance. It represents the changed view of modern students, for whom historical or higher criticism overrides any mere textual correspondence of language.

In the middle ages there was a characteristic production of lives of Christ, but they were more the work of romancers than scholars. Thus we have the Saxon *Heliand* of 830 in alliterative verse, and a generation later the Alsatian *Life of Christ* by Oufnid, the monk of Weissenburg. These books have philological interest for the study of Teutonic dialects, but are of no value for scriptural students.

The Reformation brought fresh attention to this kind of work, but Osiander's views of plenary inspiration marred the worth of his *Harmonia Evangelica*. Discrepancies he resolved by assuming that events were distinct if their chronology varied. Thus he multiplied Peter's denials of Christ to suit the varied accounts of the evangelists. Calvin's *Harmonia de Tribus Evangelistis Composita* is a more scholarly and critical production. Since his time the number of harmonists has been very great. The best of them have been Griesbach (1776), Robinson, the American (1845), and Stroud (1853). No better work on the subject is to be found than Tischendorf's *Synopsis Evangelica* (1884), which embodies the best results of modern textual study. The tendency, however, of scholarship is away from forced parallelisms and hard conciliations. The scheme of Osiander leads to wild results, and cannot be tolerated, although it supplies an easy solution of chronologies otherwise hard to reconcile. It is seen more and more that each evangelist has his own point of view and is best understood by finding the aim of his narrative and not by processes of forced reconciliation. It is found that Mark and John best accord in narrative. Harmonists are divided upon the duration of our Lord's ministry, and the division turns upon the number of Passover feasts he is reported by the evangelists to have observed. The shortest reckoning of his ministry includes but two, the longest four paschal observances. All commentators of the New Testament must deal with these discrepancies, and harmonizing is now left almost wholly to them. Among these commentaries, mention should be made of Wescott's incomplete and Lange's voluminous work. Dr. Robinson's *Harmony* has been re-edited by M. R. Riddle

(1885-86), both in English and Greek, with a text collated from Tregelles, Wescott and Hort. See also Dr. Frederick Gardiner's *Harmony of the Four Gospels* (Andover, 1871), and Canon Venables's translation of Karl Wieseler's *Chronological Synopsis of the Four Gospels* (1878). Rushbrook's *Synopticon* (1880) is a valuable collection of textual facts bearing upon the harmony of the evangelists, and may well be studied with Dr. Edwin A. Abbott's *Common Tradition of the Synoptical Gospels*.

HARMS, GEORG LUDWIG DETLEV THEODOR, a German clergyman and missionary educator; born at Walsrode in Lüneburg, May 8, 1808. After studying theology at Göttingen he taught a private school till 1844, when he became the assistant of his father, the pastor of Hermannsburg, and a strong rationalist. There he preached pure evangelicism with such vigor and emotional power that the old orthodox tenets soon supplanted the rationalism which had previously prevailed. In 1849, after he had succeeded his father, Harms founded an institute for training young men as missionaries for Africa. It grew to large proportions and to an expenditure of over forty thousand dollars. A book plant was added to the training-school, and, thanks to Pastor Harms's enthusiastic fervor, it never lacked the funds necessary for its healthy growth. He died in 1865. A biography of this good man, and a collection of his most interesting letters to friends and fellow-workers, were published by his brother THEODORE, and had a large circulation.

HARNACK, ADOLF, a German-Russian clergyman and historian, and the son of Theodosius Harnack (1817-1889), a prominent Lutheran divine and professor of Dorpat (Russia) University; born at Dorpat, May 7, 1851; studied there (1869-1872); tutor in Leipsic 1874; professor of church history at Giessen (1879), at Marburg (1886), at Berlin (1889); said to be the leader among the German church historians. Among his very important works are *The Works of the Apostolic Fathers* (1876-78, with Gebhardt and Zahn); the serial publication entitled *Texts and Researches in the History of Early Christian Literature* (1882-96, 12 vols. issued so far); *Introduction to St. Augustine's Confessions* (1888); *Text-book on the History of Dogma* (1889); *The New Testament about A. D. 200*; *Apostolic Faith Knowledge* (1892); *History of Early Christian Literature up to the Time of Eusebius* (first vol., 1893).

HARNETT, CORNELIUS, an American statesman; born, it is supposed, in North Carolina, April 20, 1723. He early manifested his opposition to the encroachments of royal authority, and, as a member of the North Carolina provincial assembly (1770-71), took the lead in many energetic protests and remonstrances; in 1773 he was placed on the committee of continental correspondence for the Wilmington (North Carolina) district. He was president of the Provincial Council, and a signer of the "Articles of Confederation and Perpetual Union." The British excluded him from the offer of a general pardon,

and when, in 1781, they had temporary possession of the Cape Fear region, he fell into their hands, and died a prisoner, at Wilmington, North Carolina, April 20, 1781.

HARNEY, WILLIAM SELBY, an American soldier, born near Haysboro, Tennessee, Aug. 27, 1800. He entered the army in 1818 as second lieutenant of the Nineteenth Infantry, and remained in continuous service until 1863, when he was placed on the retired list, having attained the brevet rank of major-general "for long and faithful service," having refused, although a Southerner by birth, to enter the rebel ranks, in spite of General Robert E. Lee's earnest appeal. General Harney took part in the Black Hawk War (1833); the Florida and Mexican wars; he completely defeated the Sioux at Sand Hills (1855). After his retirement he lived in St. Louis. Died May 9, 1889.

HARO OR SAN JUAN ARCHIPELAGO. See SAN JUAN ISLANDS, Vol. XXI, p. 266.

HARPALUS. See DEMOSTHENES, Vol. VII, p. 71.

HARPER, a city of Harper County, central southern Kansas, situated 47 miles S.W. of Wichita, on the Hutchinson and Southern and the Atchison, Topeka and Santa Fé railroads. It is the shipping center of a fertile farming section, and has shipments of grain, live-stock, hides and wool. Population 1890, 1,579; 1900, 1,151.

HARPER, a family of American book-publishers of wide reputation. The business was established in New York City by the sons of Joseph Harper, a Newton (New York) farmer. The firm's name was, at first (1817), J. & J. Harper; the members were JAMES, born April 13, 1795; mayor of New York in 1844; died March 27, 1869, and JOHN, born Jan. 22, 1797; died April 22, 1875; in 1833 the firm assumed its present name of Harper Brothers, and took in JOSEPH WESLEY, born Dec. 25, 1801; died Feb. 14, 1870, and FLETCHER, born Jan. 31, 1806; died May 29, 1877. Their first book was *Seneca's Morals*. Their plant grew to occupy nine buildings on Pearl street, New York, when it was destroyed by fire in 1853, a net loss (above insurance money) of \$750,000; the stereotype plates were saved, however, and the stock of books quickly replenished. The new building, on Franklin Square, is entirely fire-proof, and forms the most completely equipped house of the kind in the world. Their four periodicals—two weeklies, *Harper's Weekly* and *Harper's Bazar*; two monthlies, *Harper's Magazine* and *Harper's Young People*—are widely read and very profitable. The school-book department is a very important feature, and contains such standards as *Anthon's Classics* and *Harper's Latin Dictionary*. In fiction a number of high-class, copyrighted works are constantly placed upon the market. The owners of this great business are now a number of sons and grandsons of the founders.

HARPER, WILLIAM RAINEY, an American educator, was born in New Concord, Muskingum County, Ohio, July 26, 1856; at fourteen he was

graduated at the Presbyterian College, in his native town; studied at Yale University; in charge of a Masonic institute for boys in Ma-



WILLIAM RAINEY HARPER.

con, Tennessee, 1875; removed to Granville, Ohio, in 1876, and rose from a tutorship to the charge of Denison University, a Baptist college there; in 1879 became professor of Semitic languages in the Baptist Union Theological Seminary, near Chicago; professor of the same branches at Yale University from 1886 to 1891; chosen president in 1891 of the revived University of Chicago, to which office he added the labors of instruction in Semitic literature; obtained endowments of several millions of dollars for that institution, and organized it on a comprehensive scale for continuous academic terms and post-graduate work. (See UNIVERSITY OF CHICAGO, in these Supplements). Dr. Harper gave much personal service to the expansion of the Chautauqua system of general education; adopted a method of teaching language by educating grammar from the text, applied his method to text-book editions of Cæsar's *Commentaries* and the *Aeneid*; was associated with the production of text-books concerned with Biblical Hebrew and Greek; and edited *Hebraica* and *The Old and New Testament Student*.

HARPIGNIES, HENRI, a French painter; born in Valenciennes, July 28, 1819; a pupil of J. Achard; had his first paintings (landscapes) accepted at the Salon of 1853; continued to exhibit remarkably luminous landscapes, generally with some personages or cattle to enliven the scenery; he takes most of his subjects from central France and the mountainous regions of Auvergne; received medals in 1856, 1867 and 1868; also at the Paris International Exposition of 1878; Knight of the Legion of Honor in 1875; officer in the same order in 1883. His *Moonrise* is at the Metropolitan Museum, New York, and a number of his best efforts have been purchased in this country. The Luxemburg (State) Museum in Paris owns his *Oaks of Château Renard* and his *Valley of Aumonce*. Had formed a number of pupils, prominent in their art.

HARP-SEAL OR GREENLAND SEAL (*Phoca granlandicus*), the common seal hunted in the Newfoundland fisheries. It is commercially valuable for its oil and skin. The name refers to the two half-moon shape marks on the back of the male, together forming a lyre-shaped spot—the so-called "saddle." See SEAL, Vol. XXI, p. 581.

HARP-SHELL (*Harpa*), a genus of gasteropodous mollusks of the whelk family (*Buccinidae*), found in the deep waters of tropical seas. The name refers to the regular parallel ribs on the shells, which suggest the strings of a harp. The beautifully colored shells are prized highly by

shell-collectors. The animal itself is used as food by the inhabitants of Mauritius.

HARPSICORD. See PIANO-FORTE, Vol. XIX, pp. 65, 69, 70.

HARRADEN, BEATRICE, an English novelist; born at Hampstead, Jan. 24, 1864; educated at Dresden schools and in English colleges; graduated B. A. in classics and mathematics at the University of London. She belongs to a musical and artistic family, and early showed a disposition toward literature. After writing some short stories, chiefly for children, she was fortunate in appearing in *Blackwood's*. Her first book, *Things Will Take a Turn* (1891), was for children. Her



BEATRICE HARRADEN.

next, *Ships that Pass in the Night* (1893), was partly autobiographical, and secured immediate attention. Her *In Varying Moods* (1894) is a collection of stories including *At the Green Dragon*; *The Painter and His Picture*; *The Umbrella-Mender*; *A Bird of Passage*; *The Clockmaker and His Wife*; *Sorrow and Joy*; and *An Idyll of London*. She lived in California for two years on account of her health, and wrote *The Remittance-Man*, dealing with an American subject, and other stories. Her recent works are *Hilda Strafford* (1897); *Untold Tales of the Past* (for children, 1897); and *The Fowler* (1899).

HARRINGTON, MARK W., an American astronomer and meteorologist; born in Sycamore, Illinois, Aug. 18, 1848; graduated from the University of Michigan (1868); lecturer on astronomy in Oberlin College and at the Louisiana State University (1868-70); in the United States Coast Survey Service in Alaska (1871); studied in Leipzig (1876-77); professor of astronomy in the Chinese Cadet School, Peking (1878); professor of astronomy at the University of Michigan and director of its observatory (1879-91); established the *American Meteorological Journal* (1884); and elected fellow of the Association for the Advancement of Science; chief of the United States Weather Bureau (1891-95), and writer of article on Meteorology in these Supplements.

HARRIS, SIR AUGUSTUS GLOSSOP, an English playwright and theatrical manager, was born in Paris in 1852. He became the manager of several of the London theaters, and raised the performances to a high standard of excellence. Among the most successful of his plays, usually written in collaboration with other dramatic writers, were *The World*; *Human Nature*; *A Run of Luck*; *A Million of Money*; *The Prodigal Daughter*; *A Life of Pleasure*; and *The Sporting Duchess*. He was a member of the London county council, sheriff of the city of London, and a deputy lieutenant of the city of London. The Queen knighted him in 1891, on the occasion of the German Emperor's visit to London. Died in Folkestone, June 22, 1896.

HARRIS, DAVID BULLOCK, an American soldier; born in Frederick's Hall, Louisa County, Virginia, Sept. 28, 1814; graduated from the United States Military Academy (1833), entering the artillery; assistant professor of engineering at West Point (1834); resigned (1835) to engage in civil-engineering and business; joined the Confederate army as captain of engineers (1861); the first to determine the military importance of the line of Bull Run; was conspicuous for his bravery during the first battle of that name; in the staff of General Beauregard during the latter's western expedition (1862); he planned and built the works at Island No. 10 and Fort Pillow, and later the Vicksburg defenses; had charge of the engineering operations around Charleston, South Carolina (1862), and of the same kind of work around Petersburg, Virginia (1864); had just been commissioned brigadier-general when he died of yellow-fever, near Charleston, South Carolina, Oct. 10, 1864.

HARRIS, HOWELL; born 1713. See METHUENISM, Vol. XVI, p. 193.

HARRIS, ISHAM GREEN, an American soldier and public man; born near Tullahoma, Tennessee, Feb. 10, 1818; had only a meager common-school education, as a clerk in a store, and later as a merchant in a small way, he spent his evenings studying for the legal profession; admitted to the bar in 1841, he commenced practice at Paris, Tennessee; elected to the state legislature as a Democrat in 1847; elected Congressman in 1849, and re-elected in 1851. In 1853 he moved to Memphis, and from 1857 to 1863 was governor of the state. During the last three years of the war he was a volunteer aid on the staff of General Albert Sidney Johnston, and was with him when he fell at Shiloh; took part in all the important battles, except Perryville. After the war he lived 18 months in Mexico and a year in England; then resumed his profession at Memphis, Tennessee. In 1877, 1883, 1889, and 1895 he was elected to the United States Senate; and in 1893 was elected unanimously president *pro tem* of that body. His last term would have expired in 1901. Died in Washington, D. C., July 8, 1897.

HARRIS, JOEL CHANDLER, an American author; born in Eatonton, Georgia, Dec. 8, 1848; was, in turn, printer, lawyer and journalist, and by his sole, indefatigable efforts secured an education. In 1890 he succeeded his friend, Henry W. Grady (whose biography he wrote), as editor of the *Atlanta Constitution*. His delightfully original and unexpected book, *Uncle Remus, His Songs and His Sayings; The Folk-Lore of the Old Plantation* (New York, 1880), quickly carried his name even to the Old World, at once to children and scientific students of folk-lore. Later

works are *Nights with Uncle Remus* (Boston, 1883); *Mingo, and Other Sketches* (1884); *Free Joe* (1887); *Daddy Jake, the Runaway* (1889); *Balaam and His Master* (1890). His negro dialect and his way of relating incidents in every-day negro-life in Georgia are recognized as masterpieces of their kind.

HARRIS, ROBERT, a Canadian painter; born in Carnarvon, Wales, Sept. 17, 1849; educated at Charlottetown, Prince Edward Island; after trying surveying as a profession, he studied art, first from nature, later (1877) from prominent teachers in Paris and London; exhibited there, at the Salon and at the Royal Academy; settled in Canada; produced large historical paintings, such as *Fathers of Confederation* (in the library of the Parliament House, Ottawa). His *Meeting of School Trustees*, a realistic canvas of much power, figures in the Canadian National Gallery; devoted himself more especially to portrait-painting; refused to serve as president of the Royal Canadian Academy.

HARRIS, SAMUEL SMITH, an American Protestant Episcopal bishop; born in Autauga County, Alabama, Sept. 14, 1841; was graduated from the University of Alabama (1859); was admitted to the bar (1860), and engaged in the practice of his profession in Alabama until 1865, when he removed to New York. In 1869 he was ordained priest in the Protestant Episcopal Church, and held pastorates at Montgomery, Alabama; Columbus, Georgia; New Orleans, Louisiana; and Chicago, Illinois; declined the bishopric of Quincy, Illinois (1878). In 1879 he was consecrated bishop of Michigan. He published *Bohlen Lectures* (1882).

HARRIS, THADDEUS MASON, an American clergyman; born in Charlestown, Massachusetts, July 7, 1768. His father, a Revolutionary patriot, died during the war, leaving his family destitute; had to make his living on a farm; attracted the attention of Dr. Morse, the owner of a private school, and was prepared there for Harvard; was graduated in 1787; had he not been attacked with small-pox, would have been accepted as Washington's private secretary; librarian at Harvard (1781); studied theology at Worcester, and was chosen pastor of the First Unitarian Church, Dorchester, Massachusetts (1793), where he officiated for 46 years. He wrote *The Minor Encyclopædia* (4 vols., 1803); *Journal of a Tour in the Territory West of the Alleghany Mountains* (1805); *A Natural History of the Bible* (1821). He died in Dorchester, Massachusetts, April 3, 1842.—His son, THADDEUS WILLIAM, an American entomologist, was born in Dorchester, Massachusetts, Nov. 12, 1795; was graduated from Harvard (1815); practiced medicine at Milton Hill, Massachusetts; librarian of Harvard (1831); gave instruction in natural history and organized the Harvard Students' Natural History Society; was made commissioner for the zoölogical and botanical survey of Massachusetts (1837), and published a report of the insects in the state, enumerating 2,350 species; the legislature published his *Insects Injurious to Vegetation* (1841; enlarged ed., 1852); was also much interested and active in antiquarian researches.—His



JOEL CHANDLER HARRIS.

brothers, WILLIAM THADDEUS (1826-54) and EDWARD D., were also men of learning, much interested in genealogy and old state and town histories. The latter died in Cambridge, Massachusetts, Jan. 16, 1856.

HARRIS, WILLIAM TORREY, an American educator; born Sept. 10, 1835, in Killingly, Connecticut; educated at Phillips Andover Academy and Yale; superintendent of St. Louis public schools (1868-80); founded the Philosophical Society of St. Louis and the *Journal of Speculative Philosophy* (1866, the first of its character published in America); president of the National Educational Association (1875); removed to Cambridge, Massachusetts, (1880); represented the United States government at the Brussels International Congress of Educators (1880), and prepared, for the Vienna and Paris (1889) expositions, the official *Statement of the System of Education of the United States*; president of the Boston Schoolmasters' Club; commissioner of education under President Harrison; and editor of an *International Educational Series of School Books*.

HARRISBURG, a town and the capital of Saline County, southern Illinois, 60 miles N.E. of Cairo, on the Cleveland, Cincinnati, Chicago and St. Louis railroad; situated in a county abounding in salt, iron, coal and lead. Agricultural implements are manufactured here, and salt, coal and iron are found in the vicinity. Population 1890, 1,723; 1900, 2,202.

HARRISBURG, the capital of Dauphin County, Pennsylvania, and capital of the state; pleasantly situated on the left bank of the Susquehanna River, which here is crossed by four bridges, each over a mile in length. Besides the state capitol building, the city contains a courthouse, the state arsenal, the State Insane Asylum, a Roman Catholic cathedral, and some forty other churches. The state library contains about sixty thousand volumes. The prosperity of Harrisburg is due chiefly to its facilities for communication with the coal and iron districts of the state; the Cumberland Valley, Northern Central Pennsylvania, Philadelphia and Reading, and the Vanderbilt or Southern Pennsylvania railroads, all centering here, to which the facilities afforded by the Pennsylvania canal, with its outlets, may be added. As a result of the resources, it has large and important manufacturing establishments of iron, steel, boilers, galvanized iron cornices, brick, and tile. The manufactories of the city had, in 1890, a capital of \$6,700,000; and produced merchandise valued at \$10,500,000. They employ, on an average, 6,900 hands, and pay an average of \$3,370,000 annually in wages. Harrisburg is also an important depot for lumber via the Susquehanna River, and has extensive saw and planing establishments. Population 1880, 30,762; 1890, 39,385; 1900, 50,167. For history, description of capitol building, etc., see Vol. XI, p. 494.

HARRISON, a town and the capital of Boone County, northwestern Arkansas, on Crooked Creek, 39 miles E. of Eureka Springs, the nearest railroad station. It is the trade center of a farm-

ing section, and has a United States land-office, and cotton and flour mills. Population 1900, 1,551.

HARRISON, also called East Newark, a town of New Jersey, on the Passaic, opposite Newark, with which it is connected by a bridge. It has manufactures of oil and enameled cloth, wire, thread, cutlery, electrical supplies, a stone-yard, machine-shops, large steel-works, and shade-roller and trunk factories. Population 1900, 10,596.

HARRISON, a post village of Hamilton County, southwestern Ohio, situated on the state boundary, 25 miles N.W. of Cincinnati, on the White Water River, and on the Cleveland, Cincinnati, Chicago and St. Louis railroad. It contains tanneries, flour-mills, brush factories, corn-drill factory, railroad-shops, woolen and furniture factories, creameries and distilleries. It is surrounded by agricultural lands. Population 1900, 1,456.

HARRISON, FORT, a United States military post in the military department of Dakota, situate three miles from Helena, Montana, and reached by the Northern Pacific and Great Northern railroads. It is garrisoned by two companies of infantry.

HARRISON, BENJAMIN, an American statesman; a signer of the Declaration of Independence; born in Berkeley, Charles County, Virginia, about 1740. In 1773, although rather conservative in his views, he was a member of the committee of correspondence which united the colonies against Great Britain, and was five times elected to a seat in Congress. On July 4, 1776, he reported the Declaration of Independence. He opposed, at first, the ratification, by Virginia, of the Federal constitution of 1788, but finally gave it his full support. He was governor of Virginia in 1782-85, and at the time of his death was a member of the legislature. He was the father of President W. H. Harrison (his third and youngest son), and the great-grandfather of President Benjamin Harrison. He died in April 1791.

HARRISON, BENJAMIN, the twenty-third President of the United States, great-grandson of the preceding; born in North Bend, Ohio, Aug. 20, 1833; was graduated in 1852 from Miami University; studied law in Cincinnati. In 1854 he removed to Indianapolis, Indiana, where he has resided ever since when not on duty in Washington; gained a large legal practice; entered the Union army (1862) as lieutenant, and shortly afterward was appointed colonel of the Seventieth Indiana Volunteers, which he organized; served with gallantry in the Atlanta campaign, returning to civil life at the close of the war with the rank of brevet brigadier-general. In 1876 he was an unsuccessful Republican candidate for governor of Indiana, but in 1881 was sent to the United



BENJAMIN HARRISON.

States Senate for six years. In 1888 he was nominated on the Republican ticket for President of the United States, with Levi P. Morton for Vice-President. He received 233 electoral votes to 168 for Grover Cleveland, the Democratic nominee, the popular vote standing 5,439,853 against 5,540,329. Among the important measures adopted during his term were the McKinley Tariff Bill, the suppression of the Louisiana Lottery, the establishment of Mr. Blaine's reciprocity policy, the extension of the new navy, the settlement of the Chilean and Samoan difficulties, and the Bering Sea fisheries arbitration. In 1892 President Harrison was again the nominee of the Republicans, with Whitelaw Reid on the ticket for Vice-President, but this time he encountered defeat from the same rival, who succeeded him in the Presidency in 1893, Mr. Cleveland receiving 276 electoral and 5,553,142 popular votes, against Mr. Harrison's 145 electoral and 5,186,951 popular votes. He resumed his law practice and assumed the duties of lecturer of jurisprudence at the Leland Stanford Junior University, in California.

HARRISON, CONSTANCE (CARY), an American authoress, born April 25, 1845, near Alexandria,



MRS. BURTON HARRISON.

Virginia. She was descended from Archibald Cary of Amptill, Virginia, who presided over the senate of his native state from its organization and through the Revolutionary War, while on her mother's side she belonged to the Fairfax family. Educated in private schools in Virginia, she was noted in her girlhood for her piquant beauty. Her mother's home was devastated in the Civil War, and the family resided in Richmond, where, in 1867, she was married to Burton Harrison, who had been private secretary to Jefferson Davis. He became a member of the New York bar, and early established a summer residence at Bar Harbor, Maine. Mrs. Harrison's first book concerned this summer resort, and was entitled *Goldenrod: An Idyll of Mount Desert* (1879). Eight years later she published *Bar-Harbor Days*.

The literary work of Mrs. Harrison has been concerned with the scenes of her life and with society. In magazines and collections of tales she has depicted with sympathetic art life in Virginia. *Flower de Hundred* (1891) is concerned with the plantations of her native state, where kinship, hospitality and inherited culture gave rise to sunny manners. *Crow's Nest and Belhaven Stories* (1892) disclose life in quaint old Alexandria, one of the most historic cities of the South, and the pathos of the old families living through the war. In 1887 Mrs. Harrison appeared as a satirist of society manners, in *Anglomania's*. The commin-

gling of aspiring and newly opulent people with those of hereditary fortune and culture in the reports of fashion furnished her with themes that she handled with a genial but unsparing pen, and with keen appreciation of incongruities. Of this character are *A Daughter of the South* (1892); *Sweet Bells Out of Tune* (1893); *A Bachelor Maid* (1894); *An Errant Wooing*, a romance of foreign travel (1895); *A Virginia Cousin* (1896); and *A Triple Entanglement* (1898). She also wrote *The Well-Bred Girl in Society* (1898).

HARRISON, FREDERIC, an English jurist and author, president of the London Positivist Committee, was born in London, Oct. 18, 1831; educated at King's College, London, and Wadham College, Oxford; scholar (1848); first class in classics (1853); fellow and tutor (1854); called to the bar, Lincoln's Inn (1858); examiner in jurisprudence for Inns of Court (1869-76), for London University (1875-79); professor of jurisprudence, Inns of Court (1878-86); member of Royal Commission on Trades Unions (1867-69); secretary to Royal Commission for the Digest of the Law (1869-70); member of the State Trials Committee (1888). As president of the London Positivist Committee, he published numerous essays and addresses on positivism, and was the author of very many articles in the *Fortnightly*, *Contemporary*, and *Nineteenth Century*, from their commencement. Also of *The Meaning of History* (1862, expanded 1895, with a series of historical essays added); *Order and Progress* (1875); *Social Statics*, the second volume of Comte's *Positive Polity*, a translation (1875); the *Choice of Books* (1886); *Oliver Cromwell* (1888); and a great number of privately printed lectures on historical, social and religious questions. He was editor and part author of *The New Calendar of Great Men*, a dictionary of general biography, and a constant contributor to Professor Beasley's *Positivist Review*, published since 1893. He was defeated for Parliament by Sir John Lubbock in 1886; was elected an alderman by the London county council in February, 1889, but resigned in October, 1893.

HARRISON, JANE E., an English Hellenist; born in 1850; passed the Cambridge higher scholar examinations, winning the language scholarship; studied at Cheltenham, and later at Newnham, where her success was so great that she was declared by the examiners, informally, to have attained the honors standard; she made a specialty of Greek art and pottery, and traveled extensively in Europe, studying the leading collections of ancient sculpture. Returning in 1882, she began object-lessons at the British Museum, Greek Galleries and at South Kensington, where she lectured on Greek vase-painting; wrote *Introductory Studies in Greek Art; Greek Vase-Painting*. She was indorsed by such men as Professor Sedgwick and Sir E. Burne-Jones.

HARRISON, THOMAS ALEXANDER, an American painter; born in Philadelphia, Pennsylvania, Jan. 17, 1853; a pupil of Gerôme (at the École des Beaux-Arts, Paris); first-class medal, Paris Exposition (1889); knight of Legion of Honor; medal in Munich Exposition (1890). One of his pictures

is in the Luxembourg Palace state collection, and his *Crépuscule (Gloaming)* is in the Museum of Fine Arts, St. Louis. He devoted himself to marine and figure painting, with occasional landscapes. Though a resident of Paris, he was a member of the Society of American Artists, New York. His *Castles in Spain* is in the J. G. Johnson collection, Philadelphia.

HARRISON, WILLIAM POPE, an American Methodist Episcopal clergyman and author; born in Savannah, Georgia, Sept. 3, 1830; graduated from Emory College, Oxford, Georgia; entered the Methodist Episcopal ministry, and was appointed, by the General Conference South, editor of the *New Monthly Magazine* (1870); later book-editor and editor of the *Quarterly Review* (1884-86); four years chaplain of the House of Representatives, Washington; member of the Oecumenical Conference of his church, which met at Washington, District of Columbia (1891). He wrote *Theophilus Walton; or, The Magnets of Truth* (1858); *Lights and Shadows of Forty Years* (1883); *The Living Christ* (1884); *Methodist Union* (1892); *The Gospel Among the Slaves* (1893).

HARRISONBURG, a city and the capital of Rockingham County, northern Virginia, 22 miles N.N.E. of Staunton, on the Baltimore and Ohio railroad. It is in a beautiful region, between the Blue Ridge and the Shenandoah mountains. It is the trade and shipping center of a fertile agricultural tract. It manufactures carriages, farming implements and leather. Population 1900, 3,521.

HARRISONVILLE, a town and railroad center, and the capital of Cass County, central western Missouri, 38 miles S.S.E. of Kansas City. It has excellent transportation facilities, as railroads radiate from it in eight directions, among them the Kansas City, Fort Scott and Memphis and the Missouri Pacific. It ships quantities of coal and farm produce, and manufactures much flour and hardwood lumber, and has machine-shops and foundries. Pop. 1890, 1,645; 1900, 1,844.

HARRODSBURG, a town and the capital of Mercer County, central Kentucky; settled in 1773, and said to be the oldest town in the state; on the Southern railroad, 30 miles S. of Frankfort. It enjoys a reputation for its mineral waters, which makes it quite a resort; is the seat of an academy and of Daughters' College; has a variety of manufacturing establishments, including those of flour, tobacco, jean and whisky, and carries on an important trade in horses, cattle and other livestock. Population 1890, 3,230; 1900, 2,876.

HARROW SCHOOL, one of the famous English public schools, established in 1571, at Preston, near Harrow-on-the-Hill, 12 miles from London, by John Lyon, an enriched yeoman, as a free school for poor boys. It is now a strictly aristocratic institution, containing about six hundred boys, and preparing them for the universities. A number of scholarships have been founded from time to time, to secure free college education to boys of unusual ability. To meet the requirements of the age, the school is divided into

classical and modern sides, the latter being more especially devoted to scientific studies. The boys board in the various houses kept by the masters, but meet in the school buildings for common study. Among the hundreds of *alumni* of Harrow that attained prominence may be mentioned Sir Robert Peel, Cardinal Manning, Lords Byron, and Palmerston, Lord Shaftesbury, Earl Spencer, and Archbishop Trench.

HART, a village and the capital of Oceana County, western southern Michigan, 32 miles N. of Muskegon, on the Chicago and West Michigan railroad, and on the Pentwater River. It is in a grain and fruit growing region, and manufactures flour, sashes and broom-handles, and has saw-mills. Population 1890, 757; 1900, 1,134.

HART, ALBERT BUSHNELL, an American historian; born in Clarksville, Pennsylvania, July 1, 1854; was graduated from Harvard in 1880; received his Ph.D. degree from the University of Freiburg, Germany, in 1883; was successively fellow, instructor and assistant professor of history at Harvard; wrote *Coercive Powers of the United States Government* (1885); *Introduction to the Study of Federal Government* (1890). He prepared *Epoch Maps Illustrating American History*.

HART, ERNEST, an English physician and sanitary reformer; born in 1836; a brilliant pupil of the City of London School; first-prize man in every class during his stay at St. George's Hospital Medical School; ophthalmic surgeon and lecturer at St. Mary's Hospital School; wrote a book on the treatment of aneurism; chosen by the British Medical Association as the editor of their *Journal*; devoted himself to questions concerning social and sanitary progress, editing the *Sanitary Record* and *London Medical Record*; chairman of the National Health Society and the Smoke-Abatement Committee; exposed the defective arrangements for the sick poor in workhouses; urged the measures that culminated in the passage of the Metropolitan Asylums Act in 1867; established societies for the protection of infant life and for cheap concerts for the poor; helped in shaping the Public Health Acts, and in bettering the medical departments of the army and navy; worked strenuously in favor of such measures as would secure the purity of the milk supplied to cities; favored successfully the creation of an Irish peasant proprietary by the reclaiming of waste land—a measure embodied in a recent act of Parliament.

HART, JAMES McDUGAL, a Scotch-American painter; born at Kilmarnock, Scotland, December, 1828; coming to Albany, New York, by his parents, he began life in very humble circumstances, and was apprenticed to a carriage-painter; at the age of 23 he managed to go to Düsseldorf, Germany, and study in the Art School there. Landscape attracted him more particularly. In 1856 he took up his residence in New York City, and was elected a National Academician (1859). His pictures are exquisite in contours and colors without missing any of nature's touches. His best-known works are *Moonrise in*

*the Adirondacks; A Summer's Memory of Berkshire; The Drove at the Ford.* In 1889 he received a medal at the Paris Exposition for *The Rain is Over* and *In the Autumn Woods*.

HART, JOEL T., an American sculptor; born in Clark County, Kentucky, in 1810; as a boy he earned his living as a stone-cutter in Lexington, Kentucky, where he began to model busts in clay. In 1849, in Rome, where he had been sent at the expense of citizens who recognized his budding talent, he modeled the statue of Henry Clay, which is now in Richmond, Virginia. His next work was a colossal bronze statue of Mr. Clay, now in New Orleans, and the marble statue of that statesman now in the Louisville courthouse. He resided until 1879 in Florence, Italy, and finished busts and statues of many distinguished men. Among his portrait-busts are those of Jackson, Taylor and Governor Crittenden, all characteristic and truthful likenesses. His best ideal works are *Charity*, *Angelina*, the graceful *Woman Triumphant*, and *Pensive*. In all of them he showed a delicate, refined fancy. Hart invented an apparatus for obtaining mechanically the outline of a head from life, thus doing away with the great inconvenience of applying plaster direct on the skin. It consisted of a metallic shell which surrounded the head, with a space between, perforated for a large number of pins. Each pin was pushed inward till it touched the head, and then fastened there. The shell was afterward filled with plaster, which was cut away till the points of the pins were reached, thus forming a rough model. He died in Florence, Italy, March 1, 1877.

HART, JOHN, a signer of the Declaration of Independence; born in Hopewell township, New Jersey, in 1700; he was not a soldier, but a courageous public-spirited farmer. He served in the provincial legislature of New Jersey, and was a member of the Congresses of 1774, 1775, and 1776. He died in Hopewell township in 1780.

HART, SIR ROBERT, G. C. M. G., Director of Chinese Imperial Maritime Customs since 1885, was born in 1835 at Portadown, Co. Armagh, Ireland. Educated at Queen's College, Belfast; entered Consular service in China in 1854, and has since been Inspector-General and now Director of the Chinese Imp. Maritime Customs. Has many Chinese decorations. Was among the imprisoned Legionnaires at Peking during the Boxer rising of 1900.

HART, SAMUEL, an American clergyman and educator; born at Saybrook, Connecticut, June 4, 1845; graduated from Trinity College, Hartford, June, 1868, where he has been successively tutor, assistant professor and professor of Latin language and literature; entered the priesthood of the Protestant Episcopal Church; custodian of the *Standayd Prayer Book* (1886); president of the American Philological Association (1891-92); declined the appointment of bishop of Vermont (1893). He prepared editions of *Juvenal* (1873); *Persius* (1875); Bishop Seabury's *Communion Office* (1874); *Historical Sermons of Bishop Seabury* (1883-86).

HART, SOLOMON ALEXANDER, an English painter; born at Plymouth, in April, 1806, the son of a Jewish goldsmith who, in 1820, removed to London. Apprenticed first to a line-engraver, he became a student of the Royal Academy in 1823, and before he was 21 had paintings exhibited. Among his works are *The Elevation of the Law; Isaac of York; English Nobility Receiving the Communion; Henry I Receiving Intelligence of the Death of His Son; Milton Visiting Galileo in Prison; The Three Inventors of Printing.* The government bought his *Interior of a Synagogue* for the National Museum. He also painted miniatures and portraits. In 1840 Hart became R.A.; in 1857 professor of painting at the Royal Academy; in 1863 librarian of the same institution, in which office he improved materially the importance and quality of the collections in his charge. He died in London, June 11, 1881.

HARTE, FRANCIS BRET, an American novelist and poet, was born in Albany, New York, Aug. 25, 1839. His father was a schoolmaster and a man of fine education, and his son at one time designed to follow teaching as a profession. In 1854, however, he made his way to California in quest of fortune, and there, after working for a time at the mines, he became a compositor in a printing-office, and afterward undertook the editing of a local newspaper.



BRET HARTE.

In connection with the latter, he was insensibly drawn to literature, and in 1867 published, under the title of *Condensed Novels*, a collection of clever parodies of the novels of leading American and English writers of fiction. In the following year he became editor of *The Overland Monthly*, and in its pages appeared much of his earliest and most characteristic work, both in prose and verse. In 1870 he published a collection of poems, among which were the famous *Heathen Chinee* and *The Society Upon the Stanislaus*, which earned him a wide reputation as a humorist, followed by the inimitable prose sketches of realistic mining-life entitled *The Luck of Roaring-Camp*. These achievements won for him world-wide fame, and brought him an engagement to write, at a then unprecedented honorarium, a series of poems and sketches for the *Atlantic Monthly*. After this, he settled for a time in New York, when he received an appointment as United States consul at Crefeld, Germany, from which place he was transferred, in 1880, to the consulship at Glasgow, Scotland. At Glasgow, the novelist resided until 1885, when he settled in London, where he actively pursued his literary career, working chiefly, when at his best, in his old-time Californian vein. In him Western life has had no more dramatic or picturesque exponent, and no one has sketched with such vividness and animation the era of the Argonauts.



His style is at once vigorous, but easy and flexible, and in the character-drawing it is terse, vivid and racy. Rare are the skill and insight with which he seizes and portrays a situation, and with a few masterly strokes limns a figure on his canvas, bringing out, by his unerring genius, either the squalid and the base, or the noble and the heroic, elements in humanity. He has, moreover, a delicious humor, though it can at times be broad as well as subtle. His later writings are mainly in the field of fiction. The following are his chief writings: *East and West Poems* (1871); *Mrs. Skaggs's Husbands* (1872); *Echoes of the Foothills* (1874); *Tales of the Argonauts* (1875); *Gabriel Conroy* (1876); *Two Men of Sandy Bar* (1876); *Thankful Blossom* (1877); *Story of a Mine and Drift from Two Shores* (1878); *The Twins of Table Mountain, and Other Stories* (1879); *Flip, and Found at Blazing Star* (1882); *In the Carquinez Woods* (1883); *On the Frontier* (1884); *Maruja and By Shore and Sedge* (1885); *Snowbound at Eagle's* (1886); *The Crusade of the Excelsior* (1887); *A Phyllis of the Sierras and Drift from Redwood Camp* (1888); *The Heritage of Dedlow Marsh* (1889); *A Waif of the Plains* (1890); *Colonel Starbottle's Client* (1892); *A Sappho of Green Springs* (1892); *Sally Doves, and Other Stories* (1893); *A First Family of Tasajara* (1893); *A Protégé of Jack Hanlin's* (1894); *A Ward of the Golden Gate* (1894); *The Bell-Ringer of Angel's, and Other Stories; Clarence; In a Hollow of the Hills; and Stories in Light and Shadow* (1898).

HARTFORD, a city, the capital of Hartford Co., Conn., and of the state since 1873. For an account of its site, history, and government, see HARTFORD, Vol. XI, pp. 496-97. The population in 1890 was 53,182; by the twelfth census (1900), it was 79,850. The postoffice building was completed in 1883, the county courthouse in 1884, the Board of Trade building in 1891. There are several important educational institutions: Trinity College (Episcopal, founded 1823, with a library of forty thousand volumes); the Congregational Theological Seminary, and various high schools and private academies. There are fifteen miles of street-railway, and seven railroads enter the city.

HARTFORD, a village of Van Buren County, southwestern south Michigan, on the Chicago and West Michigan and the South Haven and Eastern railroads, 58 miles S. of Grand Haven, and on the Paw Paw River. It ships much farm produce, especially wheat, apples and stock. It manufactures staves, hardwood lumber and wind-mills. Population 1900, 1,077.

HARTFORD CITY, a town and the capital of Blackford County, northwestern central Indiana, 40 miles S. of Fort Wayne, on the Lake Erie and Western and the Pittsburg, Cincinnati, Chicago and St. Louis railroads. It contains a hub and spoke factory, a heading factory, flour-mill, and window-glass, paper, wood-pulp and stave factories. Population, 2,287; 1900, 2,602.

HARTFORD CONVENTION, THE. See UNITED STATES, Vol. XXIII, p. 759.

HARTING, JAMES EDMUND, an English orni-

thologist; born in London, April 29, 1841; graduated from the University of London (1860); practiced law until 1878; from his youth devoted much attention to the study of ornithology; edited the natural history column of *The Field* (1871); appointed editor of the *Zoölogist* (1877); assisted earnestly in the drafting and passing of the Sea Bird Preservation Act (1869) and the Bill for the Protection of Wild Fowl (1872); appointed Librarian to the Linnæan Society (1888); wrote *The Birds of Middlesex* (1866); *The Ornithology of Shakespeare* (1871); *Handbook of British Birds* (1872); *Our Summer Migrants* (1875); *Rambles in Search of Shells* (1876); *Ostriches and Ostrich-Farming* (1879); *British Animals Extinct Within Historic Times* (1880); *Glimpses of Bird-Life* (1880); *Essays on Sports and Natural History* (1883); and various commented reprints of ancient works on hawks.

HARTINGTON, SPENCER COMPTON CAVENDISH, MARQUIS OF. See DEVONSHIRE, DUKE OF, in these Supplements.

HARTLEY, JONATHAN SCOTT, an American sculptor; born in Albany, New York, Sept. 23, 1845; received his artistic education at the London Royal Academy and in Germany; Royal Academy medallist (1869); one of the original members of the Salmagundi Sketch Club of New York; professor of anatomy at the Art Students' League (1878-84), and for two years its president. He produced *The Young Samaritan; King René's Daughter* (1872); *The Whirlwind* (1878); a statue of Miles Morgan, erected at Springfield, Massachusetts, in 1882; and bas-reliefs on the monument at Saratoga that commemorates the defeat of Burgoyne.

HARTLEY, SIR CHARLES AUGUSTUS, an English civil engineer; born at Heworth in 1825; finishing his course in civil-engineering at Bishop Auckland and Leeds (1845); he entered the service of the Scottish Central railway; resident engineer at Sutton Harbor, Plymouth (1848); captain in the Turkish contingent engineers (1855); engineer-in-chief of the European Commission of the Danube (1856); knighted (1862); awarded the 8,000-ruble prize in the imperial competition for plans to improve Odessa harbor; consulting-engineer to the Danubian Commission (1872). Made a specialty of improvement of docks, harbors, river-outlets, and was engaged by many governments to offer plans for bettering the commercial facilities of their harbors and waterways; received many orders and medals; recommended the improvement of the south pass of the Mississippi (1874), thus assisting the successful efforts of Capt. J. B. Eads; refused his official approval to the Panama canal scheme; wrote *Delta of the Danube; Public Works in the United States and Canada; Inland Navigations in Europe*.

HARTMAN, JACOB, BARON VON, a Franco-German soldier; born in the Bavarian palatinate, Feb. 5, 1795; educated at the military schools of Bonn and St. Cyr; entered French service (1811); at Waterloo saved the eagle of his regiment,

and was made knight of the Legion of Honor; entered the Bavarian service (1815); improved materially the topographical branch of the service; major-general (1849); published a book on the Franco-Austrian war (1859); as lieutenant-general he commanded the Bavarians against the Prussians (1866); as full general he commanded a Bavarian corps against the French, and served at Paris (1870-71). He died at Würzburg, Bavaria, Feb. 22, 1873.

HARTMANN, ALFRED, a Swiss author; born Jan. 1, 1814, near Langenthal, canton of Bern; educated at the public schools of Solothurn (1827-31); studied law in the universities of Munich, Heidelberg, and Berlin. During a prolonged visit to Paris he decided to devote himself to literary pursuits. Returning to his native country he fixed his residence at Solothurn, where he formed a close friendship with the well-known painter Disteli, and where (from 1845) he published a comic periodical called *Postheiri*. He became best known through his Helvetic romance, *Meister Putsch und Seine Gesellen* (1858), and by his sketch of his friend *Martin Disteli* (1861), *H. J. Von Staal* (1861), and *Hory, Kanzler-Denkwürdigkeiten* (1876). Among his other works may be mentioned *Gallerie Berühmter Schweizer* (2 vols., 1863-71); *Junker und Bürger* (1865); *Schweizer-novellen* (1877); *Neue Schweizer-novellen*; and *Fortunat* (1879).

HARTMANN, JULIUS, a German soldier; born at Hanover, March 2, 1817; entered the Prussian Hussars (1834); attached to the staff (1848); employed in confidential missions in Schleswig-Holstein and Austria to promote Prussian interests; major-general (1865); took part in the Bohemian campaign (1866); reorganized a Bavarian army on the Prussian model (1867); fought at the head of the first cavalry division at Metz (1870); captured Tours, the provisional French capital Jan. 1871; governor of Strasburg (1871); retired 1872. He died at Strasburg, April 30, 1878.

HARTMANN, KARL ROBERT EDUARD VON, a German philosopher; born in Berlin, Feb. 23, 1842; entered the Prussian army (1858); but lameness obliged him to leave the service (1865), and he took to literature as a profession. His first work, *Philosophie des Unbewussten* (*The Philosophy of the Unconscious*), created a deep impression (1869), and in thirteen years passed through nine editions. An English translation in three volumes was published in Trübner's English and Foreign Philosophical Library. It was followed by *Zur Geschichte und Begründung Pessimismus* (1880); *Philosophie des Schönen* (1887); *Die Geister-hypothese des Spiritismus* (1891).

HARTRANFT, JOHN FREDERICK, an American soldier; born in Montgomery County, Pennsylvania, Dec. 16, 1830; graduated from Union College, New York (1853); was admitted to the bar (1859); at the beginning of the Civil War he organized the Fourth Pennsylvania Regiment. He commanded it during the three months of its enlistment, and then organized the Fifty-first Pennsylvania Regiment, becoming its colonel;

with General Burnside he captured Roanoke Island, North Carolina; was present at the battles of Bull Run (second), Fredericksburg, Campbell's Station, Knoxville, Vicksburg, the Wilderness, and Spottsylvania; especially distinguished himself by storming the bridge at Antietam; brigadier-general of volunteers (1864); brevetted major-general (1865); the same year he was made auditor-general of Pennsylvania, and re-elected in 1868. From 1872 to 1878 he was governor of the state. His administration was one of reforms and suppression of corrupt politics, Philadelphia being given a new charter, supposed to be proof against further raids upon the city treasury. He became postmaster of Philadelphia in 1879, and in 1882 collector of the port of that city. He retired in 1885 to his home in Norristown, Pennsylvania. He died Oct. 17, 1889.

HART'S FALLS. See SCHAGHTICOKE, in these Supplements.

HARTSHORNE, EDWARD, an American physician, son of Dr. Joseph Hartshorne (q.v.); born in Philadelphia, Pennsylvania, May 14, 1818; graduated from Princeton (1837), and in medicine from the University of Pennsylvania (1840); resident surgeon to the Pennsylvania Hospital (1841); physician to the Eastern Pennsylvania Penitentiary (1843); surgeon in Will's (eye) Hospital (1848), and afterward in the Pennsylvania Hospital. During the war he served as consulting-surgeon in the United States army hospitals and as an active member and secretary of the United States Sanitary Commission; wrote a *Separate System*; notes to Taylor's *Medical Jurisprudence* (1854); and *Ophthalmic Medicine and Surgery* (1856). He died June 22, 1885.

HARTSHORNE, HENRY, an American physician, and the brother of Dr. Edward Hartshorne (q.v.); born March 16, 1823; graduated from Haverford College (1839), and from the medical department of the University of Pennsylvania (1845); professor of the Institute of Medicine in the Philadelphia College of Medicine (1853); professor of the practice of medicine (1859) and of hygiene (1865) in the University of Pennsylvania. In 1867 he was called to the chair of organic science and philosophy in Haverford College. He has also been a professor in the Pennsylvania College of Dental Surgery, in Girard College, and in the Woman's Medical College of Pennsylvania. Editor of the *Friends Review* (1872); wrote *Essentials of Practical Medicine* (1869), a number of medical articles and pamphlets, two volumes of poems, and a romance, *Woman's Witchcraft*. Died in Tokyo, Japan, Feb. 10, 1897.

HARTSHORNE, JOSEPH, an American physician, and the descendant of Richard Hartshorne, a Quaker, and a co-proprietor with William Penn of the colony of East Jersey; born in Alexandria, Virginia, Dec. 12, 1779; graduated in medicine at the University of Pennsylvania in 1805, and, after two years of travel through India, settled in Philadelphia. From 1815 to 1821 he was surgeon of the Pennsylvania Hospital; edited Boyer's *Treatise on Bones*, and invented a splint for a fractured thigh. He died of cholera, in Delaware, Aug. 20, 1850.

HART'S-TONGUE, the common name of species

of *Scolopendrium*, a genus of widely distributed ferns, of which one species, *S. vulgare*, is a native of Europe and North America, and is common in moist woods, on shady banks, in caves on the seashore, and other cold and damp situations. Its fronds are, in general, undivided, although sometimes forked, and from a few inches to two feet in length and from one to three inches in breadth. The sori are in transverse lines on the lateral veins. Fine plants of this fern are ornamental, and are most luxuriant in winter.

HARTT, CHARLES FREDERICK, an American geologist; born in New Brunswick, Aug. 23, 1840. By the invitation of Louis Agassiz he entered the Museum of Comparative Anatomy at Cambridge, Massachusetts; he took part in the Thayer expedition in Brazil (1865-66); professor of natural history at Vassar College (1866); professor of geology and physical geography in Cornell (1868). He made several exploring trips in the valley of the Amazon, on the last of which he died. He organized the Imperial Geological Brazilian Committee, with which he was connected up to the time of his death, and the collections gathered are incorporated in the National Museum, Rio de Janeiro. He died in Brazil, March, 1878.

HARVARD, a thriving village of McHenry County, northeastern Illinois, 63 miles N.W. of Chicago, on the Chicago and North-Western railroad. It has several elevators, railroad repair-shops, and manufactories of farm machinery, carriages and sewing-machines. It is supplied with electric lights, and with city water from an artesian well. Population 1890, 1,967; 1900, 2,602.

HARVARD, JOHN, an American philanthropist; born at Southwark, England, November, 1607; graduated from Emanuel College, Cambridge (1635); having become a dissenting minister, he sailed for America in 1637, and the same year was made a freeman of Massachusetts. In 1638 a tract of land in Charlestown was deeded to him, where he exercised his ministerial functions. At the time of his death his net property was worth £800, one half of which he left for the erection of the college which bears his name. He also gave a library of 320 volumes. He died at Charlestown, Massachusetts, September 24, 1638. See Vol. XI, p. 500; and HARVARD UNIVERSITY, in these Supplements.

HARVARD UNIVERSITY, an important American institution of learning, established in Cambridge, Massachusetts, and including a college of liberal arts, a library of 452,512 volumes and 366,540 pamphlets, divinity, law, medical, dental, veterinary and (Lawrence) scientific schools; also a museum of comparative zoölogy, an observatory, laboratories of all kinds, and a number of buildings for the accommodation of officials and students. It was founded Oct. 28, 1636, by vote of the General Court of the Colony of Massachusetts Bay, which appropriated £400 "toward a school or college in Newtown" (the old name of Cambridge). Nothing was done, however, toward organizing the college until after the death of a young nonconformist clergyman and graduate of Emanuel College, Cambridge, named John Harvard, who died at Charles-

town, a year after his arrival in America, leaving his library (300 volumes) and half his estate (valued at £800) toward the proposed college. It was organized at once, under the title of Harvard, the first class being formed the same year. Henry Dunster, who was the first president, succeeded in obtaining a charter, May 31, 1650, which gave the new institution an independent legal existence. It was signed by Governor Thomas Dudley, and the original parchment is in the custody of the present trustees. Since then the university prospered exceedingly, and its financial resources, as well as its influence, have grown apace. July 31, 1895, the books of the treasurer showed the value of the assets of the corporation to be \$8,381,581.83, and its income during the preceding year (1894-95) to have reached a total amount of \$1,201,908.78. Since its foundation Harvard University bestowed degrees upon 19,984 graduates. In 1896, its various departments included 337 instructors and 3,290 students. See also EDUCATION IN THE UNITED STATES, HIGHER, in these Supplements.

A woman's college of liberal arts has been organized in Boston, under the name of RADCLIFFE COLLEGE (q.v., in these Supplements), and its trustees have been empowered to confer degrees to its students. Harvard professors and instructors are in charge of the teaching, and it is admitted that, so far, its standard of merit is worthy of the great institution that has fathered it. The number of students (1894-95) was 284.

HARVEST-FLIES, a name often applied to the CICADAS; q. v., in these Supplements.

\*HARVESTING MACHINERY. The earliest practice of mechanical harvesting antedates the Christian era, when the Gauls, using a box on wheels, with comb-like teeth in front, and an ox in thills to push at the rear, gathered the heads of the standing grain.

Grain-harvesting machines may be considered as falling under three types: 1. Thrust or push machines, which are known at the present time as "headers"; 2. Reapers, which throw the grain in gavels to the ground; and 3. Harvesters, which now include automatic binding attachments.

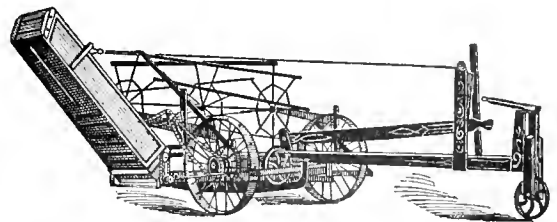

HEADER.

Headers deliver the cut grain upon the ground, or carry it continuously into a special wagon-box, from which it is stacked while still in the loose state.

In California, attachments have been mounted upon the machine to thrash and bag the grain. Binding attachments have also been placed upon them, but the practicability seems a little doubtful, because of the cumbersomeness of this type.

The idea of the push-machine seems to have first  
• Copyright, 1897, by The Werner Company.

presented itself, and the foundation for it was so well laid by the Rev. Patrick Bell of Scotland in 1826, that its principles have been but little departed from thus far, as will be learned by comparison of the modern header with the previous illustration.

Bell's machine was provided with a thrust-tongue in rear and grain-platform in front, and a reel for laying the grain backward. These machines were introduced to a limited extent into America, and, having been copied and improved, reached a high state of development by 1860.

Among the many attempts to improve the Bell type, some of them successful, was that of Cyrus H. McCormick, who, in 1834, patented the machine next shown.

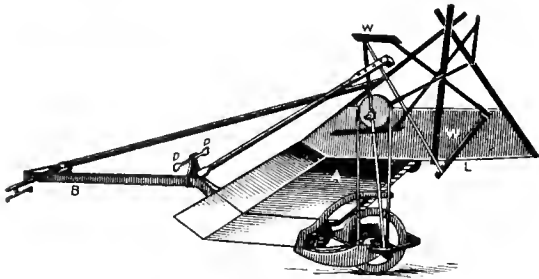

MCCORMICK THRUST-MACHINE, 1834.

It had the gearing-carriage, with the pushing-tongue in rear of the grain-platform, and a reel for laying the grain-stalks backward. Bell's self-delivering platform was removed, and the grain was received by a stationary one, from which a man with a rake, walking beside the machine, was depended upon to deliver the the grain to the ground. McCormick retained Bell's supporting-wheels, but one was placed well forward of the other, and the one next the standing grain was made small. On the machine was placed the enlarged grain-divider, employed on the then existing reaping-machines. Bell's unsupported thrust-tongue was also adhered to.

The actual development of the "header," was slow, and not until 1840 did the efforts of inventors bring it to a sufficient degree of perfection to make it acceptable, the most important improvement being the supporting of the thrust-tongue at rear upon a wheel, or wheels, by means of which the direction of travel could be controlled.

**REAPERS.** The second type is that in which the machine is drawn forward, and by a lateral-reaching cutting-apparatus and grain-platform is adapted to operate upon the standing grain, beside which the team travels.

In late machines of the class, the reel is made to serve as a rake as well, and automatically to deliver the grain to the ground at suitable intervals. The reel is supported by a vertical shaft, and as the machine is drawn forward the arms so move as to dip into the grain in front of the cutting-apparatus, lay it backward, and then rise and move forward for a new stroke. A number of arms being provided, the reeling effect becomes practically continuous. By means of a cam and the double-jointed securement of the arms, the latter are controlled at will, and made to sweep the platform and deliver the

gavel. A suitable timing-device is also provided for controlling them, which makes every arm operate as a rake, or any arm so operate, at will, or any predetermined one operate automatically. As an alarm-clock may be set to awaken the sleeper at any hour, so this device may be set to perform its duties.

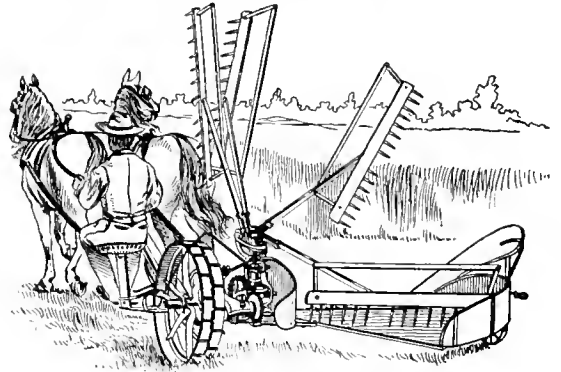

REAPER.

These machines, being light, simple, cheap, and easy to handle, still find homes on small farms.

The early forms of the reaper, up to about 1865, practically monopolized the grain-fields in America, and in other countries where cheap labor did not bar them out.

For the initiative moves in the practical development of this type of machine (from which the third type, soon to be considered, borrowed its reel, its divider, and its cutting apparatus), some credit must be given to Abraham Randall, but more to Obed Hussey than to all other early workers.

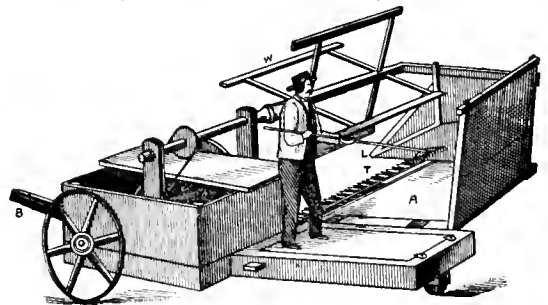

RANDALL, 1833.

The Randall machine was first practically used in 1833, but the Hussey had cut a harvest in 1832, though not patented in the United States until Dec. 31, 1833. The latter machine was so practical, that, with Bell's reel added and Randall's grain-divider, it was imitated at home and abroad. Having won a world-wide fame at a public trial in July, 1833, before the Hamilton County Agricultural Society, near Carthage, Ohio, it was soon widely manufactured, and the rights of the inventor under the patent were not questioned.

"In 1834 this machine was introduced into Illinois and New York, and in 1835 into Missouri, in 1837 into Pennsylvania, and in 1838 Mr. Hussey removed from Ohio to Baltimore, Maryland, and has continued to manufacture his reaper there up to the present time." (*Scientific American*, Dec. 23, 1854.)

The Hussey machine was practically alone, and sang the new harvest-song without accompaniment for ten years. After the value of the invention was thoroughly established, competition became general. Unfortunately, the clamor incident to business efforts has confused history. Let us brush away the cobwebs, of which the writer has watched the spinning, that obscure the successful efforts of Hussey.

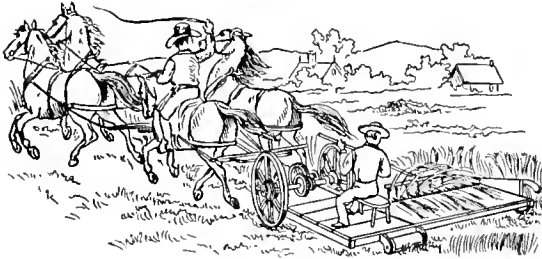

HUSSEY, 1833.

On the twenty-first day of June, 1834, while the Hussey machine was crooning the new harvest-song in Illinois, the above-mentioned patent to Cyrus H. McCormick was granted; but by mistake, as is shown in a letter written by the Commissioner of Patents, Jan. 22, 1848, while considering the matter of the extension of the patent for which an application had been made, in which letter are these words: "The principal features embraced in the said patent, viz., the cutting-knife and mode of operating it, the fingers to guide the grain, and the revolving-rack for gathering the grain, were not new at the time of granting said letters patent. The knife-fingers and

general arrangement and operation of the cutting-apparatus are found in the reaping-machine of O. Hussey, patented 31st December, 1833."

In 1844, McCormick, having previously abandoned the Bell type of machine, and having conducted experiments with the Hussey type, put a machine similar to the latter into the field, but made no provision for carrying the raker (as had Randall and Hussey) until a year or two later. Improvements were patented in 1845 and 1847, and suits were later brought against competitors. The practical defeat of his patents in the courts, however, removed the fears that threats had caused, and new factories sprang up. Fully reduced to practice, Mr. McCormick's machine later became well known, and took its place beside that of Hussey, Seymour and Morgan of New York, Manny of Rockford, Illinois, and a half-dozen others, which for a number of years monopolized the grain-fields of the Mississippi valley.

Early American makers, seeking honors abroad, sent machines to the great London exhibition of 1851, where they were given practical tests. With no competent representative, the Hussey machine yielded to its competitor, and to McCormick was given the preference; but at a subsequent trial, after the arrival of Hussey, "an all but unanimous award was given in his [Hussey's] favor," and to his rival was left the empty honor of holding a medal. (See Vol. I, p. 322.)

From 1860 to 1870 it is probable that more than 100,000 reapers were put out in America annually by the various makers; but the third type of machine, now to be considered, arrived on the scene.

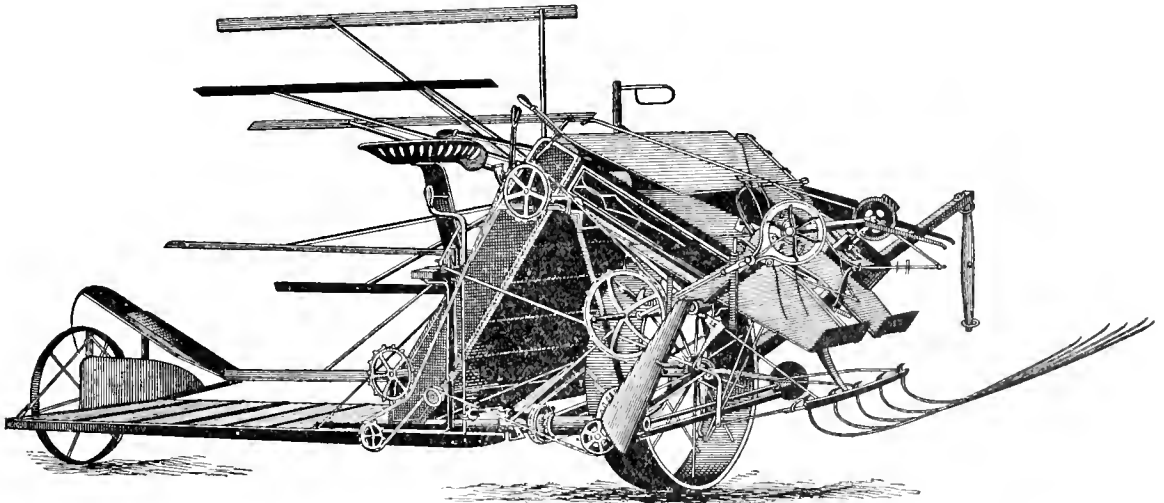

SELF-BINDING HARVESTER.

It at once made inroads into the ranks of the reaping-machines, and ultimately almost entirely supplanted them.

The third type of machine finds its full development in the modern self-binding harvester. It is drawn, not pushed, having the arrangement of cutting-apparatus, grain-divider, reel, and grain-receiving platform introduced by Hussey and Randall. To the platform is applied an endless conveyer,

placed horizontally. From this the grain is received and elevated to a sufficient height to render its swath easily controllable by the parts of the binding-attachment. The reel of the modern machine is wholly supported at one end, and is adapted to be moved forward or backward and there maintained, or to be moved into any desired position of vertical adjustment. Once cut and elevated, the grain is delivered to the automatic binding-attachment, which,

with its arms of steel and nimble fingers, takes a pre-determined quantity of straw, compresses the mass, throws a band of twine around it and deftly ties the ends. From the highest point of elevation the swath is permitted to flow down a sloping table in a path transverse to the line of advance of the machine (and transverse to the length of the straws as well), and, while still in a free state, is deflected, in order that it may so enter the binding-devices proper as to be centrally bound, and while being so deflected the tardily moving butts are hurried to their position in the receptacle. The flow of the grain is checked for a moment, and the needle, supported beneath the table and adapted to reciprocate and take the twine that is threaded into an eye at its point, and carry it to a position somewhat distant above the table, where it is delivered to a knotting-device. These last-mentioned parts are supported in proper positions by a suitable frame, and so connected by gearing as to be moved at such relative intervals of time as to make them work in harmony. From the knotting apparatus, where the end of the twine is held, to the needle's eye below the receptacle, the twine is drawn as the needle retreats, and against this twine, by means of reciprocating packing-fingers, the grain-straws, grasped wisp by wisp, are forced. The history of this last type of machine is largely written in that of the Marsh harvester, which made the unbounded success of the modern automatic binder possible.



MARSH HARVESTER.

Charles W. and William W. Marsh, trained by necessity, became experts in binding grain by hand, and believed that if they could ride upon the machine, and have the grain brought to them, they could handle it. Reasoning that grain-straws could be best formed for binding when allowed to fall into a receptacle, these inventors so provided that the swath carried from the platform-conveyer and elevated a little distance was delivered into a suitable receiver, and they constructed a stand for two men, and a table for each. As the machine moved through the field, a wisp, of the cut grain-straw was taken and a band made. The idle hand of the operator hastened the tardily moving butts of the straws and packed them into the form of a gavel. Thrusting the band through the swath of flowing straws, the operator brought the ends together, and, having united them, placed the completed bundle upon a

carrier. In heavy grain, where two men were required, the gavels, after being encircled by the band, were moved to the table and completed. It was found that one expert operator could bind as much upon the machine as four could upon the ground. Three men could do as much as six or eight could do with a reaper. In the Marsh harvester, provision was made for raising and lowering the machine in order to adapt it to operate in various heights of crop; for rocking it forward in order to tilt its cutting-apparatus and reel downward; and indeed for all the movements necessary to adjust it to its work and fit it to receive an automatic binder, should such ever be perfected.

In order to make a place for an automatic binder, succeeding inventors found it necessary merely to remove the tables, and the binder soon became an important attachment.

In retrospect, the efforts—failures and successes—in reaching this now so simple attachment seem like the struggles of a nightmare; for between 1850 and 1870 more than one hundred inventors clamored at the doors of the United States Patent-Office for recognition of their ill-considered ideas. Some of their machines were intended to bind with straw, some with wire, and some with twine. In the race, wire won at first. Its ends were more easily united by twisting than those of twine by being tied. Wire could be drawn tightly, so that neither compression nor packing was necessary. Previous to 1870, nearly all the underlying principles of the automatic binder had been made known.

When, in 1879 (mainly promoted by Gannon and Deering and Walter A. Wood), wire-binders had become well established, the twine-binding attachments had reached such perfection as to enable them to assert their superiority, and with an easy swing they took their place upon the Marsh harvester, where they are likely to remain.

In accordance with the fitness of things, the necessities of the great harvest-fields of Illinois prompted the most activity, and at Plano, in the northern part of that great state, at the very center of the then greatest grain region of America, the Marsh harvester, conceived on a farm, struggled into existence, was trained to its work, and there won its crown.

The modern twine-using binding-attachment is of the so-called John F. Appleby type, because this inventor conceived the special combination of parts which enabled its foster-parent, William Deering, to reduce the labor and expense of harvesting grain to the lowest point that it is probably destined to reach. The machine once a success, Mr. Deering, with the aid of the late Hon. E. H. Fitler of Philadelphia, turned his attention to the production of a suitable twine, and now the fibers of the Manila islands and of the sisal-fields of Yucatan are deftly made to tie the grain crop of the world.

In these machines, let us credit the broad idea of the knotting-device to Jacob Behel; the wisp-by-wisp gavel-forming mechanism to George H. Spaulding, who gave to the machine what seems to be more than human judgment, for it takes only as much at a time as is required, and so makes all bun-

dles of grain of uniform size. To Watson and Renwick, to Gordon and to Locke, must be accredited the central binding of the grain, whether long or short. To hundreds of diligent workers, the names of many of whom are enshrined in the records of the patent-offices of the United States and England, credit must be given for the fine touches which have produced this newer marvel, surpassing in its operation the skill of human hands.

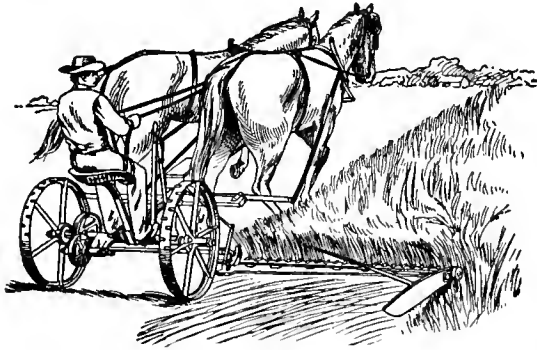

GRASS-CUTTER.

**GRASS-CUTTING MACHINERY.** The above illustration represents a modern mowing-machine. It has a light metal "frame," or gearing-carriage, adapted by suitable conformation to receive the gearing, shafts, seat, draft-tongue and coupling-frame, to which the cutting-apparatus is attached, all cast in one piece. Through a bored sleeve-like portion of this "frame" the axle passes, supported therein by roller-bearings at each end of the frame. Secured to this axle at the immediate end of the frame is a spur-gear, and on a strong pin, supported in a rearward projection of the frame, and adapted to slide longitudinally, are mounted a bevel-gear and spur-pinion as one piece, having a long hub, with roller and ball-bearings within. From beneath the axle extends forward a strong arm, to which the coupling-frame is jointed. Through this arm passes a shaft having a crank-wheel in front and a bevel-pinion in rear, the latter in position to be engaged by the bevel-gear referred to. A pitman connects the crank to the cutting-apparatus. The pin that supports the bevel-gear and spur-pinion is adapted to move longitudinally in its support, and to carry the bevel-gear and pinion with it. In the projecting arm that supports the bevel-gear sustaining-pin is a groove forming part of a spiral revolution, and in the said bevel-gear support a smaller pin is inserted, that is adapted to move in the spiral groove. A lever serves to rock this gear support, and thus throw the bevel-gear into and out of mesh with the bevel-pinion. By this last-mentioned lever the operative mechanism is shifted into action or out, at will. The supporting-wheels are secured to the axle by pawls and ratchets within the hubs, so that the machine may be backed easily without imparting motion to the cutting-mechanism. At front and rear, beneath the metallic frame, is secured a strong iron bar formed like a V, its shorter portion hinged immediately forward of the crank-shaft, and its other part at rear immediately below the crank-shaft. To this, by a compound joint, the cutting-apparatus is

hinged, so that it may be folded directly upward for traveling over the road, and the coupling-frame at the same time may be so lifted by means of a lever as to carry all parts well above the ground. Doubly hinged as the cutting-apparatus is to the gearing-carriage through the instrumentality of the coupling-frame, it may rise and fall, to conform to uneven ground. The cutting-apparatus is also free to rock, and thus conform to the inclinations and undulations of the surface of the ground over which the machine passes. By a suitable lever the cutting-apparatus may be tilted to any desired degree, and there maintained.

A lifting-spring is so connected to the main gearing-carriage as partly to sustain the cutting apparatus throughout its length, and thus throw on the traction wheels such portion of the weight as is lifted, thereby reducing the friction upon the ground.

Constructed as this most modern mowing-machine is, possessing the fine mechanical touches, its weight of 550 pounds suffices to produce traction enough to move all its working-parts, and thus enable a very light team of horses to cut and spread to the sun more than twelve acres of grass as a day's work.

The discovery of the principles embodied in the cutting-apparatus must be credited to Obed Hussey. The adaptability of the cutting-apparatus to rocking must be credited to the genius of Cyrenus Wheeler, A. B. Graham and a few others. Broadly considered, the jointing of the cutting-apparatus to the gearing-carriage, and the modern form of the machine, must be credited mainly to Lewis Miller. For the practical application and introduction of ball and roller bearings to this class of machinery, credit must be given to William Deering. A host of diligent workers must have the credit of the finishing-touches by which the crude cutting-apparatus of Hussey and the cruder framework and heavy forgings of the early jointed-bar machine were converted into the light and lasting embodiment of the principles involved.

Limited space requires us to refer mainly to the records of the United States Patent-Office, where about seven thousand efforts of inventors, successful and otherwise, are made clear. Some were ephemeral, but most of the names we mention are of those who stand head and shoulders above their co-workers in the history of this great art.

**CORN-HARVESTERS.** It having become possible to put small grain into bundles, attention was at once directed to cutting and binding Indian corn. A machine was produced, capable of gathering in the stalks as it advanced, and of throwing them into the binding-receptacle, from which they emerged bound compactly into bundles suitable for being shocked, or loaded upon wagons. The accompanying cut represents one of the latest and most effective forms. With it a team and man may easily form into bundles more than eight acres of corn in a day, thus doing the work of from four to eight men by the old methods.

As an army is led to battle, so great enterprises are led by generals; and to Jonathan Haines, George Esterly, and a few others, must be credited the grand

strategies that ended in the capture of the harvest-fields of the drier sections of America by machines of the header type.

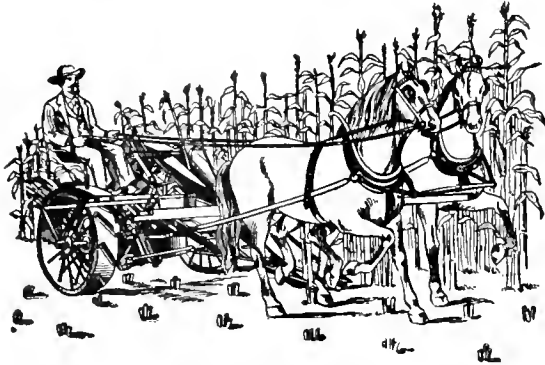

CORN HARVESTER.

To the foresight and energy of Seymour and Morgan, Walter A. Wood and D. M. Osborne, all of New York; to Leander J., Cyrus H. and William McCormick of Chicago; to Aultman, Miller and Company, of Ohio, and a few others, must be mainly credited the inroads that the reaper made; and for the successful self-binding harvester, the grandest achievement of the agricultural world (that so much influenced the opening up of the great Northwest prairie-lands of America to settlement), history must find a place on its pages, as promoters, for the names of Hussey, Charles W. and William W. Marsh, Lewis Steward, John D. Easter, Elijah H. Gammon and William Deering, all of Chicago and vicinity; Walter A. Wood and David M. Osborne of New York; George Esterly, and others, all of whose names are well known in the great industrial centers of the world.

For an account of these mechanisms from an English point of view, see AGRICULTURE, Vol. I, p. 322.

JOHN F. STEWARD.

HARVEST MOON. See ASTRONOMY, Vol. II, p. 798.

HARVEY, MOSES, a British divine and author; born at Armagh, Ireland, March 25, 1820; graduated from Belfast College (1840); ordained Presbyterian minister of Maryport, England (1843); minister of the Free Presbyterian Church, St. John's, Newfoundland, (1852-70), where he devoted much time to literary and scientific pursuits, especially to the geology and natural history of the island. Wrote *Thoughts on the Poetry and Literature of the Bible*; *The Harmony of Science and Revelation*; *Lectures, Literary and Biographical* (1864); *Newfoundland, the Oldest British Colony* (1883); *Textbook of Newfoundland History* (1885); *Where are We, and Whither Tending* (1886). He contributed to this ENCYCLOPEDIA the articles *Labrador*; *Newfoundland*; and *Scal-Fisheries of the World*.

HARVEYZED STEEL. See IRON AND STEEL, in these Supplements.

HARWICH, a village of eastern Barnstable County, Massachusetts, on the south side of Cape Cod, on the New York, New Haven and Hartford railroad. It carries on a good fishing and coast-

ing trade, and is in a region of numerous cranberry-bogs. It was settled in 1694. Population 1890, 2,734; 1900, 2,334.

HARWOOD, ANDREW ALLEN, an American sailor, and the great-grandson of Benjamin Franklin, by his granddaughter, Elizabeth Franklin Bache; born in Settle, Pennsylvania in 1802; appointed midshipman (1818), and served in the suppression of the slave-trade; lieutenant (1827); served in the Mediterranean squadron (1835-37); commander (1848); commanded the *Cumberland* (1853-55); captain (1855), and inspector of ordnance, (1858); chief of the Bureau of Ordnance and Hydrography (1861); commodore (1862); in command of the Washington navy-yard and Potomac flotilla (1862-63); retired (1869), as rear-admiral. Wrote *Summary Court-Martial* and *Law and Practice of United States Navy Court-Martial* (1867). He died in Marion, Massachusetts, Aug. 28, 1884.

HASDEU, BOGDAN PATRICEIU, a Roumanian philologist and author; born at Hatın, Bessarabia, Feb. 16, 1838; studied at the (Russian) University of Charkow; professor of history at Jassy (Moldavia) in 1856; professor of comparative philology at Bucharest (1864), where he has undertaken a *Roumanian Etymological Dictionary* on a gigantic scale, only the letter A having been completed so far. After publishing a few *Poems* (1873), and several dramas, he devoted himself to history and comparative philology. He wrote or edited *Historical Roumanian Archives* (3 vols., 1865-67); *Critical History of the Roumanian Language* (1875); *Texts and Studies of the Roumanian Language from 1550 to 1600* (1878-80). He is the editor of the periodicals, *Trajan's Column* and the *New Review*.

HASE, KARL AUGUST VON, a German theologian; born at Steinbach, Saxony, Aug. 25, 1800. Expelled from Erlangen University for his connection with the political students' union (*Burschenschaft*), he became, in 1823, a university tutor at Tübingen, but, as the result of another investigation, was afterward imprisoned for ten months. In 1828 he settled at Leipsic, and in 1830 was called to Jena as professor of theology. Here he remained until his retirement in 1883, when he was ennobled and appointed a privy councillor. He was a pronounced rationalist. In 1844 he assumed the editorship of the *Protestantische Kirchenzeitung*. He wrote *Lehrbuch der Evangelischen Dogmatik* (6th ed., Leipsic, 1870); *Hutterus Redivivus* (12th ed. 1883); *Das Leben Jesu* (5th ed. 1865; translated into English, 1859); *Kirchengeschichte* (11th ed. 1886; translated into English); *Ideale und Irrthümer* (4th ed. 1891); *Geschichte Jesu* (2d ed. 1891); and *Annalen Meines Lebens* (after his death, 1891). He died Jan. 3, 1890.

HASEBROEK, JOHANNES PETRUS, a Flemish poet; born in Leyden, Holland, Nov. 6, 1812; was graduated from the old Leyden University; completed his theological studies in 1836; was pastor successively in Heiloo, Breda, and Middleburgh in 1849, Amsterdam in 1851, and retired from the pastorate in 1883. His poetry is grace-



fully humoristic and touchingly sentimental; his favorite and most popular creation is one Jonathan, whose ways and sayings are ever droll and catching. He wrote *Waarheit en Droomen door Jonathan* (7th ed. 1887); *Windekkelken* (1859); *Nieuwe Windekkelken* (1864); *Theuwklokjes* (1878); *Winterbloemen* (1879); *Vesper* (1887).

HASHISH, an Arabian preparation of Indian hemp, known in India as *bang* (see BHANG Vol. III, pp. 627, 628) or *siddhi*. It consists chiefly of the leaves and stalks of *Cannabis indica*. The drug is used in the East in various ways. Sometimes it is smoked alone, or with tobacco. At other times beverages are prepared from it, or it is taken in the form of lozenges or electuaries. The *majoon* of Calcutta, the *mapouchari* of Cairo, and the *dawames* or *dawamesc* of the Arabs are preparations of this kind. The effects differ according to the dose and the idiosyncrasy of the individual. Some become pugnacious, while others fall into a state of reverie. After small doses there is a great tendency to causeless merriment. In most cases there is an extraordinary susceptibility to hallucinations of various kinds.

HASSAM, CHILDE, an American painter; born in Boston in 1859; pupil of Boulanger and Lefebvre, in Paris; third medal at the Paris exposition of 1889; devoted himself to landscape; settled in New York City, where he became a member of the Society of American Artists, and president of the New York Water-Color Club, as well as a member of the American Water-Color Society. His paintings are remarkable by their luminous atmosphere and their fidelity to nature.

HASSARD, JOHN ROSE GREENE, an American journalist; born in New York City, Sept. 4, 1836; graduated from St. John's College, Fordham, in 1855; assistant editor on *The New American Encyclopedia*; editor of *The Catholic World* in 1865; on the staff of *The Chicago Republican* in 1866; joined *The New York Tribune* as musical and literary editor in 1866; wrote a *Life of Archbishop Hughes* (1866); *The Ring of the Niebelungs* (1877); *Life of Pius IX* (1878); also a school *History of the United States* (1878); and *A Pickwickian Pilgrimage* (1881). He died in New York City, April 18, 1888.

HASSLER, FERDINAND RUDOLPH, a Swiss-American scientist, was born Oct. 6, 1770, in Aarau; served on the trigonometrical survey of Switzerland; came to the United States when Mr. Gallatin was Secretary of the Treasury, and through him Hassler was appointed mathematical professor at West Point Academy, 1807-11; sent by the government on a scientific mission to Europe; first superintendent of the United States Coast Survey in 1816-18, organizing the new service; chief of the Bureau of Weights and Measures; resumed the superintendency in 1832, and completed a coast triangulation from Delaware Bay to Rhode Island; wrote *System of the Universe* and some mathematical text-books. He died in Philadelphia, Nov. 20, 1843.

HASSLER EXPEDITION, an American exploration of the South American coast, so called

from the name of the vessel used. Professor Agassiz was in charge of the scientific delegation, which started from Boston, Dec. 4, 1871, and reached San Francisco, California, in August, 1872, after making a number of geological coast-observations, deep-sea dredgings and important excursions inland on the less-known points of the coast, especially in Patagonia. Some of the zoölogical results were published by Messrs. Agassiz, Lyman and De Pourtalès. The death of Professor Agassiz prevented the publication of a more complete record of this most interesting expedition.

HASTINGS, a city and the capital of Barry County, southwestern south Michigan, on Thornapple River, 32 miles S. E. of Grand Rapids, on the Michigan Central, the Lowell and Hastings and the Chicago, Kalamazoo and Saginaw railroads. It has a foundry and flouring-mills, and manufacturing of felt boots, lawn hose-reels, steam-engines and furniture. It is in a wheat-growing region. Population 1890, 2,972; 1900, 3,172.

HASTINGS, a city and the capital of Dakota County, southeastern Minnesota, on the west bank of the Mississippi River, at the entrance of the Vermilion, 20 miles below St. Paul, on the Chicago, Milwaukee and St. Paul railroad. Carriages, furniture and flour are manufactured, and the city contains grain-elevators, saw-mills, a foundry, and is a wheat and lumber market. Population 1900, 3,811.

HASTINGS, a city and the capital of Adams County, central southern Nebraska. With the recent rapid growth in population, there has been a corresponding growth in all the important institutions of the city. A land company has been organized. Since 1886 railroad facilities have increased, five roads, with eleven outlets, connecting the city with all parts of the country. Street-railway lines have increased to 18 miles. The streets are well paved and lighted. The public buildings are the Courthouse, City Hall, Opera-House, Masonic Temple, State Asylum for the Incurable Insane, City Hospital, Hastings College (Presbyterian), and academy (Roman Catholic), and Young Men's Christian Association. There are six fine public-school buildings, public library, three daily and four weekly papers, four national banks, one private bank and a loaning company. The water-plant is owned by the city. There are a good police force, fire department and free mail-delivery. There are five extensive brick-yards, two flour-mills, six lumber-yards, two foundries, three sash and door factories, a cold-storage plant and a packing-house. There are 31 jobbing-houses, and the wholesale trade in 1890 amounted to \$1,250,000. Population 1880, 4,500; 1890, 13,584; 1900, 7,188.

HASTINGS, THOMAS, an American musician; born in Washington, Connecticut, Oct. 15, 1784; had only a common-school education, but manifested, at a very early age, a taste for musical composition; taught himself the rudiments of the art out of insignificant primers; later, having become master of the village choir, he mastered the

difficulties of musical composition, with the help of an elaborate treatise on the subject, given him by his brother; assumed charge of church choirs in various New York cities; accepted the editorship of the *Western Recorder*, a religious musical paper, and lectured much and well on the subject of church music; settled in New York City (1832), continuing in the same line of work as choir-director in Dr. Mason's Church, Bleecker Street; issued the *Musical Magazine* (1835-37); published nearly fifty volumes, including *The Musical Reader* (1818); *Dissertation on Musical Taste* (2d ed. 1853); *Spiritual Songs* (1831); *Elements of Vocal Music* (1839); *Sacred Songs* (1842); *The Presbyterian Psalmody* (1852); *Hastings's Church Music* (1860); and *Intraits* (1865). He died in New York City, May 15, 1872.

HASWELL, CHARLES HAYNES, an American mechanical engineer; born in New York City, May 22, 1809; had no college education; learned his profession in a steam-engine factory, and as early as 1836 was appointed chief engineer in the United States navy, then the only one of that grade; helped design the steam-frigates *Missouri* and *Mississippi*. From 1844 to 1850, when he retired on account of ill health, he ranked as senior United States navy engineer-in-chief. He traveled through Europe, and on his return resumed the practice of his profession in New York City; was the first to put zinc into a marine steam-boiler, or the hold of an iron-built steamer, so that the galvanic action of copper bottoms and salt-water might be minimized; engineer of the State Quarantine Commission; trustee of the Brooklyn bridge; author of the *Mechanic's and Engineer's Pocket-Book* (51st ed. 1887).

HATASU OR HATSHEEPU, an ancient Egyptian princess. See EGYPT, Vol. VII, pp. 737, 777; and MUMMY, Vol. XVII, p. 22.

HATFIELD, a town of central Hampshire County, Massachusetts, on the Connecticut River, and on the New York, New Haven and Hartford and the Boston and Maine railroads, 4 miles above Northampton. Farming is the principal business of the region, especially tobacco-raising. An academy is situated here. In colonial times it was the scene of several Indian attacks. Population 1890, 1,246; 1900, 1,500.

HATFIELD, EDWIN FRANCIS, an American Presbyterian clergyman; born at Elizabethtown, New Jersey, Jan. 9, 1807; graduated from Middlebury College (1829); ordained minister after three years' study at Andover Theological Seminary (1832); pastor in St. Louis, Missouri (1832); in New York, Seventh Presbyterian Church (1835); in North Presbyterian Church, New York (1856); special agent of Union Theological Seminary (1864-66); and again (1870-73), raising large sums of money for its support; moderator of the General Assembly (1883); edited the *New York Observer Year-Book* (1871-73); wrote *Universalism as It Is* (1841); *History of Elizabeth, New Jersey* (1868); *The Church Hymn-Book* (1872); *Chapel Hymn-Book* (1873); *The Poets of the Church: Biographical Sketches of Hymn-Writers* (posthumous,

1884). He died at Summit, New Jersey, Sept. 22, 1883.

HATHOR. See ATHOR, Vol. III, p. 13.

HATTERAS, a point of land in Dare County, North Carolina, at lat. 35° 15' 12" N., long. 75° 30' 54" W. It is on a long, low, sandy island, separating Pamlico Sound from the Atlantic Ocean, and shaped like a right angle, Cape Hatteras being the vertex of the angle. The navigation is dangerous off the cape, on account of shoals extending far out to sea. Two miles north of the point stands a lighthouse, showing a flashing dioptric light of the first order, nearly two hundred feet above sea-level.

HATTERIA. See REPTILES, Vol. XX, pp. 437, 448, 450.

HATTON, JOHN LIPTROT, an English musician; born in Liverpool, England, in 1809; entirely self-educated; settled in London in 1832, and became known as a composer and conductor. As leader of the Drury Lane orchestra, he produced *The Queen of the Thames* (1844). The same year he gave, in Vienna, his opera, *Pascal Bruno*. He visited America in 1848; composed music for a number of Shakespearean revivals by Charles Kean at the latter's Princess Theatre, London, composed several cathedral services and anthems; also over 150 songs, several operas and *Hezekiah*, a sacred drama (1877). He died in Margate, Sept. 20, 1886.

HATTON, JOSEPH, an English author; born at Andover, England, Feb. 3, 1839; began to write at an early age. After editing several provincial newspapers, he was placed in charge of the *Gentleman's Magazine* (London); for many years the special correspondent of the *New York Times*; connected with various of high-class dailies, among them the *Standard* and *Telegraph*; wrote several books of note, and biographies on journalists and journalism, but his fame rests on his works of fiction. In 1865 his first novel, *Bitter Sweets*, a love-story, appeared, and in the following year, *Against the Stream*. This was followed in 1867 by *The Tallants of Barton*. His best-known novels are *Clytie* (translated into German and Swedish); *Cruel London*; *Three Recruits*; *The Queen of Bohemia*; *By Order of the Czar* (in defense of the Jews persecuted by the Russian autocrat); *Princess Mazaroff*; *Under the Great Seal*; *The Abbey Murder*; and *John Needham's Double* (dramatized and acted by E. S. Willard and his company). He also wrote a number of volumes of impressions, anecdotes on celebrities, etc. He dramatized Hawthorne's *Scarlet Letter* for Richard Mansfield.

HATZFELDT, COUNT VON, a German diplomat; born Oct. 8, 1831; son of Countess Sophie von Hatzfeldt, the friend of Ferdinand Lasalle, the Hebrew socialist. In 1862 Count Hatzfeldt was one of Count Bismarck's secretaries; during his Parisian embassy, and on the outbreak of the Franco-German war, belonged to the Chancellor's diplomatic suite. In 1874 he was appointed imperial minister at Madrid. Soon after the signing of the Treaty of Berlin he was sent as am-

bassador to Constantinople. After a three years' residence there he was recalled to Berlin to succeed Bülow as Foreign Secretary. In Nov., 1885, he became German ambassador to London.

HAUBERK. See ARMS AND ARMOR, Vol. II, p. 556.

HAUCK, MINNIE. See WARTEGG, *post*, p. 3089.

HAUKSBEE, FRANCIS. See HAWKSBEER FRANCIS, in these Supplements.

HAUPER. See HAPUR, in these Supplements.

HAUPT, HERMAN, an American engineer; born in Philadelphia, March 26, 1817; graduated from West Point in 1835; assistant engineer on the public works of Pennsylvania (1835-39); professor of civil-engineering and mathematics in Pennsylvania College (1844-47); principal engineer of the Philadelphia and Columbia railroad (1847), and superintendent in 1849; chief engineer of the Hoosac Tunnel, in Massachusetts (1856-61). He served in the Civil War as aid to General Irwin McDowell and chief of the Bureau of United States Military Railways; declined the brevet of brigadier-general of volunteers. Since 1875 he has been chief engineer of the Tide-Water Pipe Line Company, having been the first to demonstrate the feasibility of transporting oil in pipes over long distances. He wrote *Hints on Bridge-Building* (1840); *General Theory of Bridge-Construction* (1852); *Plan for Improvement of the Ohio River* (1855); and *Military Bridges* (1864).

HAUPT, LEWIS MUHLENBERG, American engineer, a son of the preceding; born in Gettysburg, Pa., March 21, 1844; graduated from West Point (1867); lieutenant of United States engineers in the lake surveys (1868); in charge of the fifth military district of Texas (1869); engineer of Fairmount Park, Philadelphia (1872); professor of civil-engineering at the University of Philadelphia (1873). He patented an automatic system for improving rivers and harbors and maintaining channels by an adjustable deflecting shield suspended by buoys, floats, or barges; edited the *American Engineering Register*; and wrote *Engineering Specifications and Contracts* (1878); *Working-Drawings, and How to Make and Use Them* (1881); and *The Topographer, His Methods and Instruments* (1884).

HAUPTMANN, GERHART JOHANN ROBERT, German poet and dramatist; born in Ober-Salzbrunn, Silesia, Nov. 15, 1862, the son of an hotel-keeper; educated at Breslau and at Jena University, and studied sculpture for two years; made a sea voyage to Italy, and opened a sculpture studio in Rome, but became ill, returned to Germany, and studied art in Dresden. In 1885 he married the daughter of a Hamburg merchant; and in 1888-92 lived in Ekner, a suburb of Berlin, preparing himself for his future career in literature. In 1894 he visited the United States. His first play, *Promethidenloös* (1885), was a weak imitation of Byron's *Childe Harold*; but he soon broke away from tradition, and his next plays, *Before Sunrise* (1889), and *The Peace Festival: A Family Catastrophe* (1890), are socialistic tragedies dealing with the proletariat. These and *Lonely People* (1891) show the influence of Ibsen and the ultra-realistic mod-

ern German school of writers. In 1892 he published *Railway Watchman Thiel* and *The Apostle*, two novelettes written some years earlier. Then came his first great drama, *The Weavers* (1892), a realistic and powerful picture of the miserable life of the poor weavers of Silesia. This was followed by *Friend Crampton* (1892) and *The Beaver Fur* (1893), two character plays marked by grim humor. Another epoch in his career came with *Hannele* (1893), wherein he deserted realism for symbolism. Next came *Florian Geyer* (1895), in which realism is combined with history, with doubtful results. *The Sunken Bell* (1896), a fairy drama, in which poetry, allegory, and symbolism are mingled, had an enormous success, mainly on account of its striking stage effects. This was followed by *Fuhrmann Henschel* (1898), another socialistic drama. Several of his plays, including *The Weavers*, *Hannele*, *The Sunken Bell*, and *Fuhrmann Henschel* have been played in the United States, either in German or in English.

HAUR, FRANZ VON, an Austrian geologist; born in Vienna, Jan. 30, 1822; educated at Vienna and Chemnitz; assistant curator of the Imperial Museum (1846); director of the Imperial Geological Institute (1867); intendant of the Imperial Court Museum of Natural History (1885); wrote a number of large works on geology, and prepared the map of Austro-Hungary (1867-73).

HAURAN, district and mountain chain in Syria. See SYRIA, Vol. XXII, 821-22; BASHAN, Vol. III, 410.

HAUSSA OR HAUSA, states of the Sudan. See SOKOTO, Vol. XXII, p. 248.

HAUSSMANN, GEORGES EUGÈNE, BARON, a French administrator; born in Paris, March 27, 1809. He first studied music, then law, and was called to the Parisian bar; entering the public service under Louis Philippe, he distinguished himself as subprefect in various southern districts. The revolution of 1848 returned him to private life. Under Napoleon III he was made prefect of Toulon, Bordeaux, and finally of Paris in 1853. He then commenced his great work of improving and embellishing Paris, which, continued until 1870, imposed upon the city a financial burden, submitted to hardly any supervision, of \$120,000,000. He created the parks of the Bois de Boulogne, the Bois de Vincennes, the Buttes-Chaumont, Montsouris, etc.; opened the Rue de Rivoli through to the Bastille, and cut through densely populated quarters the magnificent boulevards Sébastopol, Magenta, Saint-Michel, Malesherbes, Haussmann, Pereiré, Prince Eugène, etc.; created several squares and planted them with trees and flowers; erected the Central Markets, the barracks Napoleon and Prince Eugène, the enormous La Villette slaughtering-houses, the new Prefecture of Police, twelve bridges in stone or iron, the superb churches of St. Augustin, Trinity, St. Ambroise, etc., and a number of monumental fountains; perfected the unique system of sewers Paris is justly so proud of; added to the supply of city water; built the largest theaters in Paris, the Théâtre Lyrique, the Chatelet, the Gaîté, the Vaudeville, finally the National Opera (finished under the republic); erected the

New Hospital, the Hôtel-Dieu; opened sanatoriums for the poor, in the vicinity of Paris and even on the seashore; added numerous municipal and school buildings; widened and straightened hundreds of streets; finally annexed a number of small towns within the fortification-line, and increased the population of the city by 400,000 inhabitants in 1860. He was made baron and Senator in recognition of his services. There was, however, much dissatisfaction with his enormous expenditures, and charges of mismanagement being freely made, he was dismissed from office in 1870. In 1871 he became a director of the Crédit Mobilier, and in 1877 was elected to the Chamber of Deputies. "Haussmannizing" has become a popular term for the destruction of ancient landmarks to make way for improvements. He contributed his share and his editorship to a *History of Paris* (16 vols.), and wrote his *Memoirs* (2 vols., 1891). He was a Protestant by birth. Died in Paris, Jan. 12, 1891.

HAUTBOY. See OBOE, Vol. XVII, p. 705.

HAÜY, VALENTIN, a French philanthropist and the inventor of a system of printing for the blind. See BLIND, Vol. III, p. 827; and TYPOGRAPHY, Vol. XXIII, p. 696.

HAVANA, a post village, the capital of Mason Co., Ill., on the Illinois river, opposite the mouth of the Spoon river; is the shipping-point of an agricultural region, exporting chiefly corn, and Osage-orange bushes for hedges. Pop. 1900, 3,268.

HAVANA, a village of Schuyler Co., N. Y., at the head of Seneca Lake, 18 miles N. of Elmira, on the Northern Central railroad; contains mineral springs, and has machine-shops, potteries, and mills where flour, plaster, and woolen goods are made. Pop. 1890, 1,751.

HAVANA, HABANA, or SAN CRISTOBAL DE LA HABANA, the capital of Cuba. See HAVANA, Vol. XI, pp. 524-25. Population 1900, 235,981. Havana was specially prominent in connection with the struggle for Cuban independence, the destruction of the United States battleship *Maine*, and the American-Spanish war of 1898. See CUBA, "MAINE, THE," and UNITED STATES, in these Supplements. The activity of the insurgents, their destruction of crops, and the Spanish government's war measures combined to destroy the commerce of Havana; but under the new conditions the city will doubtless far outgrow even its former commercial prominence. The strength of its fortifications and the natural defenses of its position and climate saved the city from attack by the American army and navy. The insurgents, however, approached the city closely several times. On June 3, 1896, Consul-General Fitzhugh Lee entered on his duties, which terminated with his withdrawal from the city on April 9, 1898. On July 21, 1896, a plot by a Cuban patriot to blow up the government buildings was frustrated. In the fall of that year, the city suffered severely from yellow fever and smallpox, the hospitals containing nearly 10,000 sick soldiers. The pro-Spanish feeling was always very strong in Havana, and just prior to the embarkation of General Weyler for Spain a great demonstration was held (Oct. 6, 1897) to express popular confidence in his administration.

On the night of Feb. 15, 1898, the United States battleship *Maine* was blown up in the harbor. (See "MAINE, THE," in these Supplements.) On April 22, 1898, Havana and other Cuban ports were declared to be in a state of blockade, and the harbor was closed until August 12, 1898, when the blockade was raised. In anticipation of the evacuation of the city, the Spanish authorities on Sept. 26 exhumed the alleged remains of Columbus from the cathedral and shipped them to Spain, but the identity of the bones is in doubt. On Jan. 1, 1899, the Spanish flag was hauled down, and with the hoisting of the Stars and Stripes in its place Spanish sovereignty over Cuba was transferred to the United States.

HAVEN, ALICE EMILY (BRADLEY), an American authoress; born in Hudson, N. Y., Sept. 13, 1828. Under the *nom de plume* of "Alice G. Lee" she wrote sketches for various papers until 1847; edited the Philadelphia *Saturday Gazette* on the death of her husband, Joseph C. Neal, its editor, her pen-name being then "Cousin Alice." In 1853 she married Samuel L. Haven. She wrote *The Gossips of River-town*, prose and verse (1850); *Helen Morton's Trial; No Such Word as Fail; All's not Gold that Glitters; Nothing Venture, Nothing Have; Where There's a Will There's a Way*, and other popular stories for young people, all of a religious color. Died at Mamaroneck, N. Y., Aug. 23, 1863.

HAVEN, ERASTUS OTIS, an American Methodist Episcopal bishop; born in Boston, Mass., Nov. 1, 1820; graduated from Wesleyan University (1842); president of Amenia Seminary, New York (1846); entered the Methodist ministry in the New York Conference (1848); professor of Latin in Michigan University (1853). In 1856-63 he was editor of *Zion's Herald*, of Boston, and also served two terms in the Massachusetts senate and was for a time one of the overseers of Harvard University. In 1863 he was president of Michigan University; in 1869 of Northwestern University, Evanston, Ill.; in 1872 secretary of the Methodist Episcopal Board of Education; and in 1874-80 chancellor of Syracuse University, N. Y. In 1880 he was ordained a bishop. He published *American Progress; The Young Man Advised* (1855); *Pillars of Truth* (1866); and a treatise on *Rhetoric*. While ardently attached to his own denomination he was remarkable for his broad, catholic behavior toward all other Christian bodies. Died in Salem, Oregon, Aug. 3, 1881.

HAVEN, GILBERT, an American Methodist Episcopal bishop; born in Malden, Mass., Sept. 19, 1821; graduated from Wesleyan University (1846); teacher in Amenia Seminary, New York (1846); ordained a member of the New England Conference (1854). In 1854-63 he preached in churches in Massachusetts, and then traveled in Europe, Palestine, Egypt, and Greece. In 1867 he became editor of *Zion's Herald*, of Boston, and in 1872 was ordained bishop, with official residence at Atlanta, Ga. He visited Mexico in 1873 and 1876, and Liberia in 1877, as missionary superintendent. A zealous reformer, an untiring worker, and a man of wide influence, he declined all collegiate honors. Devoted much of his time and efforts to the development of the Clark University for Freedmen. He was the

author of *The Pilgrim's Wallet; or, Sketches of Travel in England, France, and Germany; National Sermons; Life of Father Taylor, the Sailor Preacher* (1871); and *Our Next-Door Neighbor; or, a Winter in Mexico* (1875). He died in Malden, Massachusetts, Jan. 30, 1880.

HAVEN, JOSEPH, an American Congregational clergyman; born in Dennis, Massachusetts, Jan. 4, 1816; was graduated from Amherst (1835); while studying at the Union Theological Seminary, New York, he taught in the Deaf and Dumb Asylum in that city; ordained pastor of the Congregational Church at Ashland, Massachusetts (1839); had charge of the Harvard Church, Brookline, from 1846 to 1850; professor of mental and moral philosophy in Amherst College (1850), and of systematic theology in the Chicago Theological Seminary (1850-70). He then traveled in Germany, Palestine, and Egypt, and from 1873 until his death was professor of mental and moral philosophy in the old Chicago University. He published *Mental Philosophy* (1857); *Moral Philosophy* (1859); *Studies in Philosophy and Theology* (1869); and *Systematic Divinity* (published posthumously, 1875). The extent and thoroughness of his scholarship were remarkable. He died in Chicago, May 23, 1874.

HAVERFORD COLLEGE, an educational establishment, founded in 1833, at Haverford, near

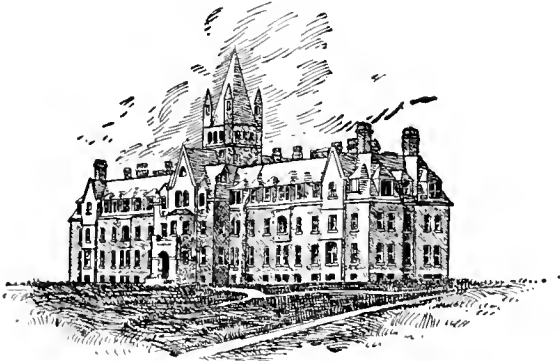

HAVERFORD COLLEGE.

Philadelphia, by a few members of the Society of Friends. It opened, in its present location, in Montgomery County, Pennsylvania, in 1833, with \$40,000 subscribed by its founders. But it changed its name and purpose from a mere school to a full-fledged college only in 1856. It contains now a number of appropriate buildings, an observatory, mechanical, chemical, physical, and biological laboratories, library, and halls for all purposes. The faculty numbers 18 members, with 116 students, and a library of 34,800 volumes. Over 650 students have graduated since the foundation of the college, which continues to be entirely under the influence of the Society of Friends. Since 1849 the admission has not been restricted to Friends or their sons. See FRIENDS, SOCIETY OF, these Supplements.

HAVERGAL, FRANCES RIDLEY, an English devotional and religious writer, youngest daughter of the Rev. William Henry Havergal (q. v.). She was born at Astley Vicarage, Worcestershire, Dec. 14, 1836, and was educated at the Luisenschule, in Düs-

seldorf. At the age of seven years she wrote hymns and letters in verse, but published nothing until 1860, when she began to contribute to *Good Words*. Her principal work was a *Life of the Rev. William Henry Havergal*, her father. In addition she wrote upward of thirty devotional works. Of these the most noteworthy were *The Ministry of Song* (1871); *Four Happy Days* (1873); *Royal Bounty* (1877); *Loyal Responses* (1878); *Red Letter Days* (1879); *Poetical Works* (1881); and *Letters* (1885). She died in Swansea, Wales, June 3, 1879.

HAVERGAL, WILLIAM HENRY, an English clergyman and composer of sacred music, was born at Chipping Wycombe, Buckinghamshire, in 1793. He was educated at the Merchant Taylors School and at St. Edmund Hall, Oxford, where he graduated in 1815. In 1829 he was presented to the rectory of Astley, near Bewdley. A severe accident compelled him to relinquish his clerical ministrations for several years, during which period he devoted himself to the study of music. His initial venture as a composer was a successful setting of Heber's well-known hymn, *From Greenland's Icy Mountains*, as an anthem. The profits from this work, as of many of his other compositions, he devoted to charitable purposes. In 1836 he obtained the Gresham prize-medal for his *Evening Service in A*, and a similar distinction in the following year for his anthem, *Give Thanks*. Other anthems and services followed, and in 1844 he began his labors toward improving the psalmody by the publication of a reprint of *Ravenscroft's Psalter*. In 1845 he was presented to the rectory of St. Nicholas, Worcester, and to an honorary canonry in the Cathedral. In 1847 he published *The Old Church Psalmody*, and in 1854 an excellent *History of the Old Hundredth Tune*. In 1859 he brought out *A Hundred Psalm and Hymn Tunes*, of his own composition. In addition to these works he wrote a number of songs and rounds for the young, besides many hymns, sacred songs, and carols for the periodical press. "As the pioneer of a movement to improve the musical portions of the Anglican services," says Sir George Grove, in his *Dictionary of Music and Musicians* (1893), "Mr. Havergal's labors deserve more general recognition than they have hitherto met with. At the time when church music was at its lowest ebb, the publication of his *Old Church Psalmody* drew attention to the classical school of English ecclesiastical music, and paved the way for the numerous excellent collections of hymns and chants which the Anglican Church now possesses." He died at Leamington, England, April 19, 1870.

HAVERHILL, a city of Essex County, northeastern Massachusetts, pleasantly situated on the Merrimac river, 18 miles from its mouth, and connected with Boston by the Boston and Maine railroad. Its manufactures have a capital of \$8,000,000, and produce, on an average, \$25,000,000 worth of merchandise annually. The average number of employees is 15,000, with wages averaging \$7,000,000 annually. The principal industry is the manufacture of fine boots and shoes, in the production of which the city ranks third in the country. In February, 1882, a large part of the business portion of the city was

destroyed by fire, involving a loss of nearly \$2,000,000. Rebuilding was promptly begun. See also HAVERHILL, Vol. XI, pp. 526-27. Population 1880, 18,472; 1890, 27,412; 1900, 37,175.

HAVERHILL, a village and one of the capitals of Grafton County, central New Hampshire, on the Boston and Maine railroad, and on the east bank of the Connecticut river. Leather, lumber, whetstones, paper, starch, and boxes are made. Population 1890, 2,545; 1900, 3,414.

HAVERSIAN CANALS. See ANATOMY, Vol. I, pp. 314-315.

HAVERSTRAW, a post village of Rockland County, southeastern New York, situated on the Hudson River, 38 miles from New York city, and on the New Jersey and New York railroad. It has a paper-mill, large print-works, a rolling-mill for copper, and engages extensively in the manufacture of brick. Population 1900, 5,935.

HAVILAND, JOHN, an English architect; born at Gundenham, Somersetshire, December 15, 1793. He studied with James Elmes. In 1815 he entered the imperial corps of engineers of Russia; and the following year removed to the United States, where he made a special study of penitentiary buildings, among them that at Pittsburg, the first designed on the radiating principle advocated by Jeremy Bentham; the Eastern Penitentiary at Philadelphia; the Tombs, New York; and the state penitentiaries of New Jersey, Rhode Island, and Missouri. He also designed the United States Naval Asylum at Norfolk, the United States Mint at Philadelphia, and other public buildings. His prisons were considered standard at the time, and were visited by commissioners from England, France, Russia, and Prussia. He died in Philadelphia, March 28, 1852. See ARCHITECTURE, in these Supplements.

HAVRE DE GRACE, a village of Harford County, northeastern Maryland, on the south bank of the Susquehanna river, at its entrance into Chesapeake Bay, and on the Philadelphia, Wilmington, and Baltimore railroad. It has a fine harbor, shipyards, a trade in lumber and coal, fruit-canning factories, shoe factories, tin-can factories, saw, planing, and flour mills, fish-packing establishments, and extensive shad and herring fisheries. The famous canvas-back ducks are obtained in the vicinity. Population 1900, 3,423.

HAWAIIAN ISLANDS, a group of 12 islands (7 inhabited and 5 uninhabited) in the North Pacific Ocean. Census of 1900: Area, 6,449 square miles; population, 154,001; capital, Honolulu (on the southwest coast of Oahu), with a population of 39,306. For the history, government, productions, and early statistics, see Vol. XI, pp. 528-32.

In 1843 the independence of the Hawaiian government was formally guaranteed by the English and French governments in the family of Kamehameha III. When Kamehameha V died in 1872, it ended the line of the Kamehamehas, and a chief named Luñalilo was elected to the throne. He died in 1874, and another chief, Kalakaua, was elected. A new constitution was adopted in 1887. Under it the members of both Houses of Parliament were

elected by the vote of all the adult male subjects, under the provisions of an educational qualification on suffrage, and, in the case of the House of Nobles, a property qualification.

King Kalakaua died in San Francisco, Jan. 20, 1891, of Bright's disease. In 1876 he visited the United States and Europe. His habits were wild and extravagant. Princess Liliuokalani succeeded her brother. Her husband was an Englishman. She was constantly at variance with her legislature and advisers, and in January, 1893, attempted to promulgate a new constitution, depriving foreigners of the right of franchise and abrogating the existing House of Nobles, at the same time giving herself the power of appointing a new House. This was resisted by the foreign element of the community, who at once appointed a committee of safety, and called a mass-meeting of their class, at which about fifteen hundred were present. That meeting unanimously adopted resolutions condemning the action of the Queen and authorizing a committee to take into further consideration whatever was necessary to protect the public safety. The committee issued a proclamation to the Hawaiian people, formed itself into a provisional government, took possession of the national property, and sent commissioners to the United States inviting the annexation of the Hawaiian Islands. The United States did not respond, but, recognizing the Hawaiian republic as a fact, continued its old friendly relations. A constitutional convention held session from May 20 to July 3, 1894, and on July 4 the constitution was proclaimed, the new government calling itself the "Republic of Hawaii." For details of this revolution, see UNITED STATES, in these Supplements, p. 2995.

Soon after the establishment of the republic plots for the restoration of the monarchy were discovered, and in January, 1895, actual conflicts occurred between the royalist rebels and the government forces. The ringleaders were, however, arrested, brought to trial, and condemned to death, the extreme sentence being later commuted to heavy fines and long terms of imprisonment. On Jan. 1, 1896, the prisoners were released. Ex-Queen Liliuokalani was also arrested and tried, and her complicity in the plots having been shown, she was sentenced to a modified form of imprisonment for five years. While under arrest the Queen penned her renunciation of the throne, and admitted the validity of the acts of the republican government. In February, 1896, she received a conditional pardon, which was afterwards made absolute. Much discussion was provoked in Congress by a proposition that the American government should undertake the construction of a cable line to Hawaii, the interest being intensified by a real or pretended dread that Great Britain might seize the opportunity to lay the cable, and perhaps proceed to a seizure of the islands, the establishment of a protectorate, or the exercise of influences over the new republic that would prove hostile to United States' interests.

For some time the Japanese laborers, who had been imported into the islands, under contract, until they formed about one-third the male population, seemed

likely to prove a source of trouble. The Hawaiian government began to enforce existing immigration laws, and thus drew from Japan diplomatic protests against violations of treaty rights in this regard. Early in 1897 three immigrant steamers were compelled to carry back to Japan the passengers they had brought, and who were not allowed to land. Legal and diplomatic proceedings failed to settle the question, and the Japanese government ordered the cruiser *Naniwa* to Honolulu. At the same time the United States government despatched the *Philadelphia* to that port,—a mere hint of the interest that Americans were taking in the islands. The differences between Japan and Hawaii were finally left to arbitration.

Meanwhile the question of annexation to the United States was a live issue, the republican administration of Hawaii working toward that end, while certain sugar-growing and other interests formed a strong party in opposition. In the United States the question had similarly met with both support and opposition, the proposed annexation treaty which President Harrison sent to the Senate in February, 1893, being withdrawn by his successor, President Cleveland, a few weeks later. Throughout the latter's administration the Hawaiian question excited much discussion; and some activity displayed by ex-Queen Liliuokalani, and her visits to Washington, lent color to rumors that she would receive American countenance in the event of her attempting to reestablish her monarchy.

On the 16th of June, 1897, President McKinley sent to the United States Senate a treaty of annexation; but no action was taken thereon by that body until the following January, when the conflict of opinion became very marked in the discussions. The policy of expansion, especially beyond the geographical boundaries of the American continent, aroused fears of imperial aggrandizement, and this subject later became of much more importance by the events of 1898 and the war with Spain (concerning which see UNITED STATES, in these Supplements). The Hawaiian legislature, however, ratified the treaty on the 10th of September, 1897, and it only remained for the action of the United States Senate to complete the annexation. All attempts, however, to secure definite ratification by that body failed; but a solution of the difficulty was arrived at by the passage, after much discussion and vigorous opposition, of a joint resolution of both Houses, which was signed by President McKinley on the 7th of July, 1898. The text of the resolution is as follows:

"WHEREAS, The Government of the Republic of Hawaii having in due form signified its consent, in the manner provided by its constitution, to cede absolutely and without reserve to the United States of America all rights of sovereignty of whatsoever kind in and over the Hawaiian Islands and their dependencies, and to cede and transfer to the United States the absolute fee and ownership of all public, government, or crown lands, public buildings or edifices, ports, harbors, military equipment, and all other public property of every kind and description belonging to the Government of the Hawaiian Islands, together with every right and appurtenance thereunto appertaining; therefore.

"Resolved, By the Senate and House of Representatives of the United States of America, in Congress assembled, that said cession is accepted, ratified, and confirmed, and that the said Hawaiian Islands and their dependencies be, and they are hereby, annexed as a part of the territory of the United States, and are subject to the sovereign dominion thereof, and that all and singular the property and rights hereinbefore mentioned are vested in the United States of America.

"The existing laws of the United States relative to public lands shall not apply to such lands in the Hawaiian Islands; but the Congress of the United States shall enact special laws for their management and disposition; provided that all revenue from or proceeds from the same, except as regards such part thereof as may be used or occupied for the civil, military, or naval purposes of the United States, or may be assigned for the use of the local government, shall be used solely for the benefit of the inhabitants of the Hawaiian Islands for educational and other public purposes.

"Until Congress shall provide for the government of such islands, all the civil, judicial, and military powers exercised by the officers of the existing government in said islands shall be vested in such person or persons, and shall be exercised in such manner, as the President of the United States shall direct; and the President shall have power to remove said officers and fill the vacancies so occasioned.

"The existing treaties of the Hawaiian Islands with foreign nations shall forthwith cease and determine, being replaced by such treaties as may exist, or as may be hereafter concluded, between the United States and such foreign nations. The municipal legislation of the Hawaiian Islands not enacted for the fulfilment of the treaties so extinguished, and not inconsistent with the joint resolution nor contrary to the Constitution of the United States, nor to any existing treaty of the United States, shall remain in force until the Congress of the United States shall otherwise determine.

"Until legislation shall be enacted extending the United States customs laws and regulations to the Hawaiian Islands, the existing customs relations of the Hawaiian Islands with the United States and other countries shall remain unchanged.

"The public debt of the Republic of Hawaii lawfully existing at the date of the passage of this joint resolution, including the amounts due to depositors in the Hawaiian Postal Savings Bank, is hereby assumed by the Government of the United States; but the liability of the United States in this regard shall in no case exceed \$4,000,000. So long, however, as the existing government and the present commercial relations of the Hawaiian Islands are continued, as hereinbefore provided, said government shall continue to pay the interest on said debt.

"There shall be no further immigration of Chinese into the Hawaiian Islands, except upon such conditions as are now or may hereafter be allowed by the laws of the United States; and no Chinese, by reason of anything herein contained, shall be

allowed to enter the United States from the Hawaiian Islands.

"The President shall appoint five commissioners, at least two of whom shall be residents of the Hawaiian Islands, who shall, as soon as reasonably practicable, recommend to Congress such legislation concerning the Hawaiian Islands as they shall deem necessary or proper.

"Section 2. That the commissioners hereinbefore provided for shall be appointed by the President, by and with the advice and consent of the Senate.

"Section 3. That the sum of \$100,000, or so much as may be necessary, is hereby appropriated out of any money in the treasury not otherwise appropriated, and to be immediately available, to be expended at the discretion of the President of the United States of America for the purpose of carrying this joint resolution into effect."

In accordance with the terms of the resolution, President McKinley appointed the following commissioners: Sanford B. Dole, ex-President of the Hawaiian Republic; Walter F. Frear, Justice of the Supreme Court of Hawaii; Senator Shelby M. Cullom, of Illinois; Senator John T. Morgan, of Alabama; and Representative Robert R. Hitt, of Illinois.

The commission met at Honolulu in August, and thereafter prepared measures providing for the erection of the annexed islands into a Territory of the United States, to be called the Territory of Hawaii. These measures were submitted by the President to Congress on the 6th of December, and they await the action of that body.

The formal ceremonies of transferring possession to the American authorities took place on the 12th of August at Honolulu. The former president of the Hawaiian Republic, Sanford B. Dole, conducts the executive department of the government under the new *régime*.

The original importance of these islands to the United States was due to their commercial and agricultural value, their utility as coaling and cable stations, and the desirability of keeping other nations—possible foes—from establishing military and naval stations so near American shores or where so many American people and interests are located. Since the cession of the Philippines to the United States, however, the possession of the Hawaiian Islands has become a military, naval, telegraphic, and commercial necessity.

AREA OF THE ISLANDS AND MOVEMENT OF POPULATION. The areas of the island groups are as follows: Hawaii, 4,210 square miles; Maui, 760; Oahu, 600; Kauai, 590; Molokai, 270; Lanai, 150; Niihau, 97; Kahoolawe, 63; total, 6,449. The islands are to a great extent mountainous and volcanic, but the soil is highly fertile and productive.

According to the census of 1896 the population was composed of 31,019 natives; 8,485 half-castes; 21,616 Chinese; 24,407 Japanese; 15,191 Portuguese; 3,086 Americans; 2,250 British; 1,432 Germans; and 1,534 other foreigners; total, 109,020. The native population is closely allied, ethnologically, to the Maoris of New Zealand. At the time of Captain Cook's discovery of the islands, in 1778, the population

numbered probably 200,000. Since then the natives have rapidly decreased, and since the census of 1878 there has been a decrease in the native population of 13,069. The foreign element, however, is rapidly increasing. The total arrivals from 1886 to 1895, inclusive, were 55,661; the departures during the same period, 32,862; showing a surplus of immigrants over emigrants of 22,799. Most of the immigrants are Chinese and Japanese.

All forms of religion are permitted and protected. Nearly all the natives are Christians. There is a Church of England bishop at Honolulu, as well as a Roman Catholic bishop, and ministers of various denominations. Schools are established all over the islands; the sum allotted for public instruction in 1896 being \$227,695. In 1892 there were 168 schools, with 10,712 pupils; of the latter, 5,353 were Hawaiians, 1,866 half-castes, and 2,253 Portuguese.

The revenue of the republic for 1897 amounted to \$2,282,454; expenditure, \$1,924,358. The revenue was largely derived from customs and internal taxes. The debt on Dec. 31, 1897, was \$4,390,147. The interest varies from 5 to 12 per cent.

In 1897 the total exports, practically the whole of which went to the United States, amounted in value to \$15,934,000, of which sugar (\$15,390,000), rice (\$226,000), coffee (\$100,000), and bananas (\$75,000), formed the largest part. The imports, amounting in 1897 to \$8,838,000, of which 76 per cent were brought from the United States, consisted largely of groceries, provisions, clothing, grain, timber, machinery, hardware, and cotton goods.

Steamers connect the islands with the American continent, Australasia, and China. In the inter-island traffic 20 steamers and 28 sailing vessels are constantly engaged. In 1897 there were 62 vessels belonging to the islands, of 34,066 tons. There are about 88 miles of railway in the islands of Hawaii, Maui, and Oahu. There are telegraphs in the islands of Maui and Hawaii, between Hawaii and Oahu, and around the latter island; total length 250 miles. The various islands also are connected by telegraphic cables. Nearly every family in Honolulu has its telephone, and the system is in operation in the islands of Oahu, Kauai, Hawaii, and Maui. The postal service is very thoroughly organized, and the islands are included within the Postal Union. In 1897 the total number of letters, etc., transmitted and received by the post office was 6,377,761, and there were 81 post offices. The postal savings bank system has over 3,000 depositors.

The city of Honolulu is lighted by electricity, and there is a system of tram cars. Several evening, daily, and weekly papers and monthly magazines are published in English, Hawaiian, Portuguese, Japanese, and Chinese.

HAWARDEN, a small market town of Flintshire, North Wales, seven miles W. of Chester. The church, almost destroyed by fire in 1857, was restored from designs by Sir G. G. Scott. A free library was opened in 1889. Hawarden Castle, the seat of the late W. E. Gladstone, dates from 1752. The park contains the ruined circular keep of a







thirteenth-century castle, which commands a good view of the valley of the Dee.

**HAWEIS, HUGH REGINALD**, an English clergyman and author; born at Egham, Surrey, April 3, 1838; graduated from Trinity College, Cambridge (1859). He was in southern Italy with Garibaldi during the famous campaign of 1860, and wrote an account of the scenes he had witnessed. After being curate of two London parishes for six years he was appointed incumbent of St. James Church, Marylebone, in 1866. He took a great interest in the welfare of the lower classes, diffused knowledge among them by his penny readings, and advocated the opening of the museums on Sundays. In 1868 he was made editor of *Cassell's Family Magazine*, and in 1885 and 1893 lectured in the United States. He wrote *Music and Morals; Thoughts for the Times; Speech in Season; Arrows in the Air; American Humorists; Unsectarian Family Prayers; The Broad Church; or, What is Coming? His Life of Sir Morell Mackenzie*, the surgeon who attended Emperor Frederick III in his fatal illness, caused a great sensation, not altogether of a flattering nature.

**HAWESVILLE**, a city and the capital of Hancock Co., Ky., on the Ohio river. Tobacco-raising and coal-mining are the chief occupations. It is in the centre of the Kentucky coal-beds, and eight mines are in operation. Population 1900, 1,041.

**HAWKBIT**, the *Leontodon autumnale*, or fall dandelion, a plant of weedy aspect, belonging to the family *Compositæ*, closely related to the dandelion. The name is due to the deep, tooth-like lacerations of the leaves. It is a native of Europe, but is naturalized in parts of the United States.

**HAWKE'S BAY**, a provincial district of North Island, New Zealand; area 4,410 square miles; population 1896, 34,038. It presents rich alluvial plains and undulating hills, with enormous forests. The bay was first entered by Captain Cook, on Oct. 8, 1769, and was named after Sir Edward Hawke, then First Lord of the Admiralty. Napier (population 8,300) is the port and chief town.

**HAWKESBURY**, a river of New South Wales, which rises in the Cullarin Range, and, under the names of Wollondilly and Nepean, flows northeast; then turns, as the Hawkesbury, southeast, and enters Broken Bay, near lat. 34° 30' S., about 20 miles N. E. of Sydney. Its length is 330 miles, and it is navigable for vessels of one hundred tons as high as Windsor. The Hawkesbury is crossed by a steel girder bridge (1886-89), one of the largest structures of its kind in the world; it completes railway communication between Brisbane and Adelaide.

**HAWKING**. See **FALCONRY**, Vol. IX, p. 5.

**HAWKINS, BENJAMIN WATERHOUSE**, an English scientist and author; born in London, Feb. 8, 1807; graduated from St. Aloysius College; studied art under the sculptor William Behnes; from 1827 devoted himself to natural history; began the restoration of extinct animals in gigantic models in 1852; assistant superintendent of the London Crystal Palace Exposition (1851), where were placed 33 of his life-size models, one of them (the iguanodon) so colossal that he gave a dinner to 12 people within its

body; made a visit to the United States in 1868, lecturing and building models of antediluvian animals for the Central Park Museum, New York. Wrote *Popular Comparative Anatomy* (1840); *Comparative View of the Human and Animal Frame* (1860); *Atlas of Elementary Anatomy* (with T. H. Huxley, 1865); *Artistic Anatomy of Cattle, Sheep, etc.* (3d ed. 1873); *Artistic Anatomy of the Horse* (5th ed. 1874). He died in New York city in 1889.

**HAWKINS, HAMILTON SMITH**, American army officer, was born in South Carolina, Nov. 13, 1834. In July, 1852, he was appointed from New York state as cadet to the Military Academy, and remained there till January, 1855. On April 26, 1861, he entered the regular army as second lieutenant of the Sixth Infantry, and was promoted to be first lieutenant May 17, 1861, and captain Sept. 20, 1863. For gallant and meritorious services in the battle of Gettysburg, he had, in July previous, been brevetted captain, but he declined the honor; and he also declined the offer of brevet major which was made to him Oct. 11, 1865. From 1861 to 1865 he occupied the staff position of regimental quartermaster of the Sixth Infantry. He was appointed major of the 10th Infantry Oct. 31, 1883; lieutenant-colonel of the 23d Infantry Feb. 17, 1889; and colonel of the 20th Infantry Aug. 13, 1894, when he was placed in command of Fort Leavenworth, Kansas. After the war with Spain broke out, he was made brigadier-general of the volunteers; and as commander of the First Brigade of Kent's division he did excellent service at the battles of El Caney and San Juan, near Santiago de Cuba, July 1-3, 1898. Later he was made major-general of volunteers; and on Nov. 13, 1898, he was retired.

**HAWKINS, SIR HENRY**, an English criminal jurist, was born at Hitchin, Hertfordshire, Sept. 14, 1817, and educated at Bedford School. He was called to the bar in 1843, and rapidly acquired an extensive criminal practice. As a prosecutor he was dreaded by the criminal classes, while his success in pleading for the defense was as remarkable. He was appointed a queen's counsel in 1858, was for many years one of the leaders of the Home Circuit in England, and was engaged in nearly every *cause célèbre* in English courts. In the Roupell forgery case he exhibited that masterly skill in cross-examination which later did so much to discomfit the witnesses for the Tichborne claimant. In the prosecution of this impostor he led the case for the crown, and insured conviction by his remarkable abilities. (See **TICHBORNE**, in these Supplements.) He became judge of the Queen's Bench Division of the High Court of Justice on Nov. 3, 1876, and was knighted. As an able and impartial criminal judge, he had few equals. Invariably lenient to the oppressed, for the villain and the knave his severity was inflexible. To the criminal classes he became known as "the hanging judge." His knowledge of criminal law and practice was most thorough, and his decisions were masterly expositions of legal principles. A keen lover of field-sports, a brilliant wit, with a deep knowledge of human as well as legal affairs, his was an interesting personality in the life of the British metropolis.—ANTHONY HOPE

**HAWKINS**,—his cousin, sought fame and found it in the field of letters, under the name of Anthony



ANTHONY HOPE HAWKINS.

Hope. The son of a clergyman of the Church of England, who kept a school for boys in that dreariest of London suburbs, Hackney, he was born in 1863. His father educated him at Leatherhead, and later sent him to Marlborough School, where he passed five years preparatory to matriculating at Balliol College, Oxford, in 1880. Here he took a good degree and was honorably mentioned as an English essayist. In 1886 he was chosen president of the Oxford Union, that debating society where many an English statesman first tries his oratorical wings. Then he entered the Middle Temple and read law, being admitted to the bar in 1887. He defended a few clients, with poor success, and acted as marshal to his relative, Sir Henry Hawkins. His first attempt in the literary field was *A Man of Mark* (1890), the story of some swindling financiers in a South American republic. *Father Stafford* (1891) fell flat at first. *Mr. Witt's Widow* (1892) and a series of short stories, reprinted from the *St. James's Gazette* under the title of *Sport Royal* (1893), had better success. Then a Parliamentary career attracted him, and he was handsomely defeated by the Hon. G. N. Curzon in one of the divisions of Buckinghamshire. *A Change of Air* (1893) and *Half a Hero* (1893), the latter a story of colonial politics, were more successful than his Parliamentary venture. His persistence and his pure English style were beginning to interest the critics and the reading world. Success came in solid form in 1893, when *The Prisoner of Zenda* came from the Arrowsmith press. It was a modern story of incident, the scene being laid in an imaginary kingdom. With a soldier for a hero, a beautiful woman for a heroine, sprightly dialogue, and a polished style, the book was a striking success. Emerson's aphorism as to all mankind loving a lover applied also to one who could so faithfully portray human affection. The famous *Dolly Dialogues* (1894), followed by *The God in the Car*, *Comedies of Courtship*, and *The Indiscretion of the Duchess*, failed to satisfy the demand for his writings. He turned to the field of his first success, and with *The Heart of Princess Osra* (1896); *Phroso* (1897); *Simon Dale* (1898); *Rupert of Hentzau* (1898); and *Lady Ursula* (1898), was welcomed as a writer of novels of adventure. His *Prisoner of Zenda* was equally successful on the stage, and, with a poetic sense of the fitness of things, in 1896 its author married the beautiful actress, Evelyn Millard, who had created the rôle of his Princess of Zenda.

**HAWKINS, SIR RICHARD**, an English sailor, and son of Sir John Hawkins (q. v.); born, probably at Plymouth, England, about 1562; accompanied his father in his freebooting expeditions

to the West Indies, also to the Portuguese coast; commanded the *Swallow* in its fight against the Armada (1588); started on a trip around the world, on board the *Dainty* (1593); rounded Cape Horn; sacked Valparaiso de Chili; finally was captured in San Mateo Bay (June 22, 1594) by the Spanish fleet sent in pursuit; sent to Spain and imprisoned (1597); escaped (1598); recaptured and finally ransomed (1602); knighted, elected to Parliament and made Vice-Admiral of Devon (1604); took part in Sir Robert Mansell's expedition against the Algerine pirates (1620); died in London, April 17, 1622.

**HAWKINSVILLE**, a city and county seat of Pulaski County, central Georgia, on the Ocmulgee (navigable) River, 40 miles S. of Macon, and on the Southern and the Oconee and Western railroads. It has cotton warehouses, cotton factory, steam grist-mill, manufactures carriages and wagons, and is an agricultural shipping-point. Population 1890, 1,755; 1900, 2,103.

**HAWK-MOTH**. See *Moths*, under **BUTTERFLIES**, Vol. IV, p. 596.

**HAWKS, FRANCIS LISTER**, an American Episcopal clergyman; born in New Berne, North Carolina, June 10, 1798; graduated with highest honors from the University of North Carolina, 1815; admitted to the North Carolina bar, 1819, but, after a few years of marked success in the practice of law, took up the study of theology, and was ordained deacon in 1827, and priest shortly afterward. Assistant rector of Trinity Church, New Haven, Connecticut, 1829, and the same year at St. James's, Philadelphia. Professor of divinity in Trinity College, Hartford, 1830; rector of St. Stephen's Church, New York, 1831. From December of 1831 to 1843 he was rector of St. Thomas's, New York, and from 1845 to 1849, of Christ Church, New Orleans; rector of Calvary Church, New York, 1849. In 1862 he resigned and went to Baltimore, where he became rector of Christ Church, but in 1865 returned to New York. As conservator of documents and historiographer of the Protestant Episcopal Church, he visited England, 1836, and brought back eighteen large folio volumes of manuscripts concerning the Church of England in America; published two volumes of extracts, etc., which were so severely criticised that he gave up the task; was unfortunate in his personal financial affairs and was unpractical in business; he declined several bishoprics. Besides the work above mentioned, he wrote *Commentary on the Constitution and Canons of the Protestant Episcopal Church in the United States* (1841); *Auricular Confession in the Protestant Episcopal Church* (1850); *History of North Carolina* (Vol. 1, 1857); also a number of translations and compilations. He was a forceful orator and a man of sincere religious enthusiasm. Died in New York City, Sept. 26, 1866.

**HAWKS-BEARD**, a name applied to *Crepis*, a genus of annual and biennial plants belonging to the family *Compositæ*, so closely related to Hawkweed (*Hieracium*) that some of the species are referred to the one genus or the other, according

to the peculiar views of individual botanists. The species are widely distributed through Europe and Asia. Doubtful medicinal properties have been ascribed to several species, and *C. lacera*, a native of the Apennines, is said to be poisonous.

**HAWKS BEE OR HAUKS BEE, FRANCIS**, an English natural philosopher; born in the latter half of the seventeenth century, and died about 1730. Was elected a fellow of the Royal Society (1705), and appointed curator of experiments to the society, and elected assistant secretary (1722). He carried further the tentative observations by Drs. Gilbert and Boyle (see Vol. VIII, pp 3, 4) on the subject of electricity, and by his experiments laid the scientific foundations of that branch of knowledge between 1704 and 1713. He contributed forty-three memoirs to the *Philosophical Transactions*, chiefly on subjects connected with chemistry and electricity. His chief work, published in 1709, is entitled *Physico-Mechanical Experiments on Various Subjects*, most of which refer to the action of light and electricity. Well known as the improver of the earlier air-pumps of Boyle, Papin and Hooke, and as the first who used glass in the electrical machine.

**HAWKS BILL TURTLE**. See **TORTOISE**, Vol. XXIII, p. 459.

**HAWKSHAW, SIR JOHN**, an English civil engineer; born in Leeds, April 9, 1811; received only a common-school education; but studied engineering under the famous engineers, Fowler and Alexander Nimmo; he succeeded the latter in the management of the Bolivar copper-mines in Venezuela (1831); returning to England (1834), he was engaged on a number of railroads and other public works at home and abroad, among them, the Southwestern Railway and Charing Cross and Cannon Street railways in London, the Riga-Dunaburg and Dunaburg Witpepsk railways in Russia; the new Spithead forts; the tunnel under the Severn; the great canal from Amsterdam to the North Sea; the docks of Buenos Ayres, and a number of bridges. This is only a very small part of his work. He was consulting engineer for the Suez canal, the navigation of the Nile, the navigation of the Weaver, England, etc.; knighted (1875); president Institution of Civil Engineers (1862), and of the British Association (1875). A man of immense working capacity and of deep and original intellect. Died in London, June 2, 1891.

**HAWLEY**, a village of Wayne County, north-eastern Pennsylvania, situated on the Lackawaxen River, 8 miles S. E. of Honesdale, and on the New York, Lake Erie and Western and the Erie and Wyoming Valley railroads, and also on the Delaware and Hudson canal. It has a large business in the transfer and forwarding of coal. Its other more important industries are silk and lumber manufacturing, and glass-blowing and cutting. Population 1900, 1,925.

**HAWLEY, JOSEPH ROSWELL**, an American statesman, born in Stewartville, North Carolina, Oct. 31, 1826; graduated from Hamilton College, New York (1847); admitted to the Connecticut bar (1850). In 1857 he became editor of the

Hartford *Evening Press*. Enlisted in the Union army as a lieutenant, in 1861; received special praise for gallantry at Bull Run; with A. H. Terry, raised the Seventh Connecticut Volunteers, a three-year regiment, and was its lieutenant-colonel; commanded the regiment in the battles of James Island and Pocotaligo; made a brigadier-general in Terry's division, Tenth Corps; became brevet major-general,



JOSEPH R. HAWLEY.

and in 1866 was mustered out. In April of the same year he was chosen governor of Connecticut; held the office one year, and returned to journalism as editor of the *Hartford Courant*, with which the *Press* had been consolidated; president of the Republican national convention (1868); elected a member of Congress (1872); was re-elected to the Forty-third and Forty-sixth Congresses. He was elected to the United States Senate in 1887 and again in 1893. Was president of the United States Centennial Commission from its organization to the close of the exposition.

**HAWTHORNE, JULIAN**, American author and son of the novelist, **NATHANIEL HAWTHORNE**, q. v. Vol. XI, pp. 536-538; was born in Boston, Massachusetts, June 22, 1846. He studied at Harvard College, but left it without graduating, to devote himself to engineering studies in Dresden, Germany. In 1870 he visited the United States, intending to return to Dresden, but the Franco-German War interfered with his plans, and he became connected with General McClellan's staff of hydrographic engineers, then at work on the New York docks, and remained attached to this service until mid-summer, 1872. Meanwhile, he contributed short stories to American magazines, which, being well received, he henceforth devoted himself to literature. Returning to Germany, he published, in England and in this country, two imaginative novels, *Bressant* (1873), and *Idolatry* (1874), and, settling in London, issued through the *Contemporary Review* and afterward in book form, his *Saxon Studies* (1876), a series of German sketches, the fruit of his residence in Dresden. Hawthorne now essayed longer flights in fiction, beginning with *Garth* (1877), and continuing in *Sebastian Strome* (1879); in *Fortune's Fool* (1883); and in *Noble Blood and Dust* (1883). Besides these, he produced a number of short stories and novelettes of varying merit, and one or two dealing with crime and its detection. Of the latter class was *A Fool of Nature*, which obtained the ten thousand dollar prize offered by the New York *Herald*,

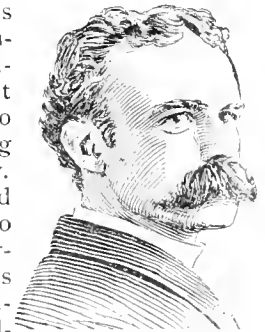

JULIAN HAWTHORNE.

in 1896. Two other kindred stories, founded on facts furnished by a New York detective, are *A Tragic Mystery*, and *The Great Bank Robbery* (1887). His other detective stories include *Another's Crime*; *American Penman*; *Section 558* (1888); *The Trial of Gideon*; *David Poindexter's Disappointment* (1889); and *Confessions of a Convict* (1893). In 1887 Mr. Hawthorne issued a collection of critical papers, chiefly on literary subjects, entitled *Confessions and Criticisms*, and in 1893, in conjunction with Leonard Lemmon, he prepared a text-book on *American Literature*. He has also served journalism fitfully, on one occasion being on the staff of the London *Spectator*; at another, acting as literary editor of the New York *World*. His other writings embrace *Archibald Malmaison* (1878); *Laughing Mill* (1879); *Ellice Quentin*; *Prince Saroni's Wife* (1880); *Beatrice Randolph*; *Love; or, a Name* (1884); *Miss Cadogna*; *Mrs. Gainsborough's Diamonds* (1885); *Constance*; *John Parmalee's Curse* (1887); and *The Professor's Sister* (1888). He also edited and published (1884) *Dr. Grimshawe's Secret*, a posthumous romance by his father, and in 1885 a biography of the latter, entitled *Nathaniel Hawthorne and His Wife*. In 1889 Mr. Hawthorne visited Europe, with a large delegation of workingmen, to examine into the condition of European industries.

HAXO, FRANÇOIS BENOIT (1774-1838). Distinguished French engineer. See FORTIFICATIONS, Vol. IX, pp. 463, 464.

HAY, JOHN, an American author and diplomat; born in Salem, Indiana, Oct. 8, 1838; graduated from Brown University, 1858; admitted to the bar of the supreme court of Illinois, 1861, but immediately afterward made assistant secretary to President Lincoln. He acted also as his adjutant and aide-de-camp, and served for some time under General Hunter and General Gillmore, with the rank of major; he was also brevetted colonel. He was first secretary of legation at Paris, *chargé d'affaires* at Vienna in 1867-68, and then secretary of legation at Madrid. From 1870 to 1875 he was on the editorial staff of the New York *Tribune*, and from 1879 to 1881 was first assistant Secretary of State under President Hayes; was elected president of the International Sanitary Congress, held in Washington, 1881. He published *Pike County Ballads* (1871); *Castilian Days* (1871); and, with John G. Nicolay, *History of the Administration of Abraham Lincoln*. He translated Castelar's *The Republican Movement in Europe* (1874-75). Appointed minister to England in 1897, and Secretary of State on Aug. 16, 1898.

HAYCRAFT ELECTROLYTIC PROCESS. See GOLD AND GOLD MINING, *ante*, p. 1417.

HAYDEN, FERDINAND VANDEVEER, an American geologist; born in Westfield, Massachusetts, Sept. 7, 1829; graduated from Oberlin College, 1850; and, as M.D., from Albany Medical College, 1853; the same year he explored the "Bad Lands" of Dakota, and in 1854-56 was in the basin of the upper Missouri, bringing back fine collections of minerals and fossils. From 1859 to

1862 he was naturalist and surgeon to the expedition sent out to explore the Yellowstone and Missouri rivers under Capt. W. F. Reynolds, and in the latter year became assistant surgeon of volunteers in the United States army. In 1863 he was promoted full surgeon, and in 1865 resigned with the brevet of lieutenant-colonel. Professor of mineralogy and geology in the University of Pennsylvania, 1865-72; became connected again with the government geological surveys, and in 1879 was made United States geologist in charge of the Montana division. In 1886 his failing health compelled him to resign. He is the author of a very large number of scientific papers and government reports. He was elected a member of the National Academy of Sciences. Died in Philadelphia, Pennsylvania, Dec. 22, 1887.

HAYES, AUGUSTUS ALLEN, an American chemist; born at Windsor, Vermont, Feb. 28, 1806; graduated from the Norwich (Vermont) Military Academy; studied chemistry under Prof. J. F. Dana, and settled in Boston in 1828, where he became consulting chemist of some of the most important dyeing, bleaching, gas and smelting works in New England. He discovered the organic alkaloid color-compound sanguinaria, carried through experiments which led to the construction, in 1838, of improved furnaces and boilers, suggested the process of reducing pig to malleable iron without loss by the use of the oxides of iron, as well as new processes in copper-smelting, the decomposition of alcohol and the formation of chloroform, and made important investigations into the properties of guano. He also examined the constitution of sea water and fresh water at various depths, prepared a report for the Navy Department on the copper-sheathing of vessels and supplied a novel process for the manufacture of saltpeter. He used electricity to determine the purity of water at different depths; was for many years state assayer of Massachusetts, and wrote a number of papers on his many valuable observations and discoveries. Died in Brookline, Massachusetts, June 21, 1882.

HAYES, ISAAC ISRAEL, an American explorer of the Arctic regions; born in Chester County, Pennsylvania, March 5, 1832; graduated as M.D. from the University of Pennsylvania, 1853. The same year he sailed as surgeon of the second Grinnell expedition in search of Sir John Franklin, and was the first civilized man to place foot on Grinnell Land. In 1860 he sailed in command of the schooner *United States*, and claimed to have reached a point which he called Cape Lieber, in lat. 81° 35' N., long. 70° 30' W. Some explorers think that his calculations were incorrect, and that he reached Cape Joseph Good, about lat. 80° 15' N., long. 70° W. In 1869 Hayes again entered the Arctic Circle, in the *Panther*. During the Civil War he was surgeon of volunteers, and attained the brevet rank of lieutenant-colonel. He received gold medals from the London and Paris Geographical Societies. He published *An Arctic Boat Journey* (1860); *The Open Polar Sea* (1867); *Cast Away in the Cold*;

*A Story of Arctic Adventure for Boys* (1868); and *The Land of Desolation* (1871). Died in New York City, Dec. 17, 1881.

HAYES, RUTHERFORD BIRCHARD, an American statesman, the nineteenth President of the United States; born in Delaware, Ohio, Oct. 4, 1822; graduated at Kenyon College, Ohio, 1842, and at Harvard College Law School, 1845; began the practice of law at Lower Sandusky in 1845 and in 1850 removed to Cincinnati, where he was city solicitor in 1859-61; was appointed major of the Twenty-third Ohio Infantry and shortly afterward lieutenant-colonel, when he commanded the



RUTHERFORD B. HAYES.

regiment until December, 1862; distinguished himself in the campaigns of West Virginia and in the battles around Winchester. At South Mountain he was severely wounded. In 1863 he was promoted brigadier-general, and the following year was brevetted major-general. From 1864 to 1866 he was a member of Congress from Ohio, and from 1867 to 1871 governor of the state, being elected for a third term in 1875, an honor never bestowed before in Ohio. In 1876 he was the Republican candidate for President of the United States. At the following election, the results of which were hotly disputed and finally settled by a special Electoral Commission (q.v., in these Supplements), he was chosen over Mr. Samuel J. Tilden by a majority of one vote in the Electoral College, and was inaugurated March 5, 1877. He chose W. M. Evarts as his Secretary of State and John Sherman as his Secretary of the Treasury. Shortly after his inauguration he restored North Carolina and Louisiana to full state rights by withdrawing the United States troops therein stationed and recognizing their Democratic governors, Wade Hampton and Nichols. He gave its first serious impulse to civil-service reform; brought to a successful issue the resumption of specie payments Jan. 1, 1879, without impairing the credit or the commercial prosperity of the country; made strong efforts to check the destruction of the United States forests, and showed himself a determined adversary of the free coinage of silver, of any trans-oceanic canal that would not be under the direct control of the United States. His policy may be characterized as wise, conservative and truly American in the highest sense of the word. At the expiration of his term, March 3, 1881, he retired to his home in Fremont, Ohio, and withdrew altogether from public life. Died at Fremont, Ohio, Jan. 17, 1893.

HAYNAU, JULIUS JAKOB, BARON VON, Austrian general; born at Cassel, Germany, Oct. 14, 1786. Entering the Austrian service in 1801, he became noted, during the Italian campaigns of 1848-49, for

military skill and ruthless severity at the capture of Brescia, gaining the name of "Hyæna of Brescia." He was engaged in the siege of Venice, when he was summoned by the Emperor to Hungary, in May, 1849, to take the supreme command of the forces in that country. The storming of Raab, his victory at Komorn, his occupation of Szegedin, and his victories on the Theiss contributed materially to the final success of the Imperialists, but his atrocious severity toward the defeated Hungarians excited the detestation of Europe. Appointed governor of Hungary after its pacification, he was dismissed in 1850 for insubordination. He died in Vienna, March 14, 1853.

HAYNE, an illustrious family of South Carolina.—ISAAC; born in Beaufort district, South Carolina, Sept. 23, 1745; was cavalry officer in the Revolutionary War, and upon the surrender of Charleston was paroled upon the condition that he should not take up arms against the British. Later, Lord Rawdon ordered him to aid in the defense of the city, but, declaring that his parole was nullified by such a summons, he again joined the Colonial army, and, being captured by the British, was hanged without court-martial, Aug. 4, 1781.—PAUL HAMILTON, a poet; born Jan. 31, 1831, in Charleston, South Carolina; was educated to the law, but early turned to literature and became editor of *Russell's Magazine*; in 1865 removed to Augusta, Georgia, and became editor of the *Constitutionalist*; ended his life in retirement near Groveton, July 6, 1886. He published *Sonnets and Other Poems* (1857); *Avolio* (1860); *The Poems of Henry Timrod* (1873); *Lives of Robert Y. Hayne and Hugh S. Legaré* (1878). For ROBERT YOUNG, see Vol. XI, p. 543.

HAYS, ISAAC, an American physician; born in Philadelphia, July 5, 1796. He graduated at the University of Pennsylvania, and practiced medicine in Philadelphia, especially as an oculist. In 1820 he became editor of the *American Journal of the Medical Sciences*; in 1869, associated his son with him, who still edits the magazine; in 1843, established the *Medical News* and in 1874 the *Abstract of Medical Science*. He edited *Wilson's American Ophthalmology*; *Lawrence's Treatise on Diseases of the Eye*; *Arnott's Elements of Physics*. The code of ethics of the American Medical Association was framed by Dr. Hays. It has been adopted by every medical society in the United States. He died in Philadelphia, April 13, 1879.

HAYTER, HARRISON, a British civil engineer; born at Falmouth, England, April 10, 1825; studied applied science at King's College, London; began as civil engineer on the Stockton and Darlington railroad; worked afterward upon the construction of the Great Northern railroad; in 1857, became assistant to Sir John Hawkshaw; in 1870, his partner. In 1895 he was engaged in constructing a system of docks at Buenos Ayres, to cost twenty-five million dollars.

HAYTI, a republic, formerly a French colony, now governed by a constitution adopted June 14, 1867; area (embracing the western portion of the island of Hayti), 10,204 square miles; population 1895, 1,400,000, about nine-tenths of whom are

negroes; capital, Port-au-Prince, with a population of 50,000. For early history, productions, government and statistics, see HAYTI, Vol. XI, pp. 543-546.

The religion of the republic is chiefly Roman Catholic. Public elementary education is free. There are about four hundred national schools, besides several private schools, and five public lycées. The official language is French. As a result largely of long-continued civil war, there has been much disorder in financial affairs, and in 1893 there was a total indebtedness of \$16,993,347.

The army, under a "law of reorganization" passed in 1878, consists of 7,000 men, chiefly infantry. There is a special "guard of the government," numbering 650 men with 10 generals, who act as aides to the president. In 1895 Hayti had a navy of five gunboats.

In 1893 the imports amounted to \$10,143,757, two thirds of them from the United States, while the exports were valued at \$12,163,959. The chief articles exported were logwood, 160,000,000 pounds; coffee, 78,000,000 pounds; cacao, 3,000,000 pounds; mahogany, 35,000 feet. The total revenue for the year was \$7,465,249.

The following is a list of the presidents of Hayti, from the date of the republic:

Presidents.	Assumed Office.
General Fabre Geffrard.....	Jan. 23, 1850
Sylvestre Salnave .....	March 27, 1867
General Nissage Saget .....	May 15, 1870
Michel Domingue .....	May 15, 1874
Boisrond Canal .....	July, 1876
General Salomon .....	Oct. 22, 1879
General Légitime .....	Oct. 22, 1888
General L. M. L. Hippolyte.....	Oct. 17, 1889
General T. A. Simon Sam .....	March 26, 1896

The president's constitutional term is seven years; and his salary \$24,000.

The historic outline for the last decade has been largely interwoven with that of Santo Domingo, which embraces the eastern portion of the island of Hayti. On Jan. 1, 1880, the Republic of Hayti was reported as "tranquil"; and this state of things continued notwithstanding serious government trouble in Santo Domingo until 1883, when a negro insurrection broke out in Port-au-Prince; but this was suppressed Sept. 22, of the same year. In 1886 great troubles arose because of large thefts of funds from the National Bank of Hayti, resulting in convictions of doubtful desert and imprisonments against which the English and American governments protested. The prisoners were soon after released. In 1888 a revolution took place in Hayti, and Salomon was deposed. He fled to Cuba, August, and died in Paris, Oct. 19, 1888. A little later an insurrection took place under General Télémaque; and during the month of October, while engaged in an attack on the Palais National at Port-au-Prince, he was killed with about three hundred of his followers. General Légitime was elected President, Oct. 22, 1888, and General Hippolyte was installed as President at Haytien, Jan. 1, 1889. A conflict of authority and immediate war followed. Légitime was defeated Jan. 29, 1889, and General Hippolyte was defeated Feb. 20, 1889; subsequently the latter advanced on Port-au-Prince, and soon became re-established in office. President Hippolyte repressed another outbreak in 1891, granting amnesty to the lesser participants on Jan. 1, 1892. His official term was afterward marked with several incipient revolts. General Hippolyte died March 24, 1896.

Louis Mondestin Florvil Hippolyte, a Haytien general, was born at Cape Haytien in 1827. His

mother was a Frenchwoman, and his father one of the negro ministers of the Emperor Faustin I. He was educated in France, and entered upon a military career. His defense of the fortress of Belair in the revolution of 1865 was a notable achievement. After the ten-months' war in 1888, General Hippolyte proclaimed a general amnesty, and since that time affairs in the negro republic have been progressing very peaceably.

General Tiresias Augustin Simon Sam, Hayti's new President, succeeding General Hippolyte, issued another amnesty proclamation immediately upon taking his seat.

HAYTIEN, CAPE, OR CAPE FRANÇOIS, a seaport town of the Republic of Hayti, on the northern coast of the island of Hayti, at lat. 19° 46' N., long. 72° 14' W. In the middle of the eighteenth century this town was very prosperous, having a university and an academy of music. In 1791, however, it was burned by Toussaint l'Ouverture; and in 1842 it was destroyed by an earthquake. Its trade is now mostly with the United States. Population, about 12,000. Its original Indian name was Guarico.

HAYWARD, a village and the capital of Sawyer County, northwestern Wisconsin, on Namakagon River and the Chicago, St. Paul, Minneapolis and Omaha railroad, 65 miles S.W. of Duluth. Its principal business is lumbering, its largest saw-mill having a capacity of 40,000,000 feet of lumber per year. It also has planing and feed mills. It has a public library, electric lights and city water. Population 1900, 2,720.

HAZARA, the name of a mountainous district in Afghanistan, between Herat and Cabul. Also, of a peculiar Mongol tribe of herdsmen, inhabitants of the Hazara district. See also AFGHANISTAN, Vol. I, p. 235.

HAZEN, WILLIAM BABCOCK, an American general; born at West Hartford, Vermont, Sept. 27, 1830. He graduated at West Point in 1855, and served against the Indians in California, Oregon and Texas; in 1861 became assistant professor of infantry tactics at West Point, and was made a captain in the same year; soon after took command of the Forty-first Ohio Regiment, and joined General Buell's army. In 1862 he was appointed to command a brigade; fought at Shiloh and Corinth; at the battle of Stone River saved the left wing from being vanquished. He took part at Chattanooga, and in Sherman's march to the sea, commanded a division. With this he captured Fort McAllister, Dec. 13, 1864, and was promoted major-general of volunteers. After the war, Hazen was made colonel of the Sixth Infantry of the Regular Army. In December, 1880, he was appointed chief signal officer, with the rank of brigadier-general. While in this office he sent Lieutenant Greely to Lady Franklin Bay, to make meteorological observations, introduced the "cold-wave signals," promoted the use of local and railway weather signals; organized special observations for the cotton-producing states, established frost warnings, and initiated forecasts for vessels coming to this country from Europe. He published *The School of the Army in Germany and France, with a*



*Diary of Siege-life at Versailles* (1872); *Narrative of Military Service* (1885). He died in Washington, District of Columbia, Jan. 16, 1887.

HAZLEHURST, a village and the capital of Copiah County, southwestern Mississippi, 35 miles south of Jackson, on the Illinois Central Railroad. It is the shipping and trading point for a large cotton-raising section. It has some manufactures, principally of cotton and cotton-seed oil. Population 1900, 1,579.

HAZLETON, a city of Luzerne Co., Pa., in a great anthracite coal region, and on two great railroads, the Lehigh Valley and the Pennsylvania; manufactures undertakers' supplies, pianos and organs, spring-guns, iron, and flour; and a beef company, established in 1884, does an extensive business. The public schools are excellent. The miners' hospital is a commodious building. There are public halls and numerous churches, and two daily, one semi-weekly, and two weekly papers, and three banks. Pop. 1890, 11,818; 1900, 14,230. See Vol. XI, p. 549.

HAZLITT, WILLIAM CAREW, an English author, grandson of William Hazlitt; born Aug. 22, 1834; educated for the law, but early turned his attention to literature. He is the author of *History of the Venetian Republic* (4 vols., 1860); *Sophie Lauric*, a novel (1865); *Memoirs of William Hazlitt* (1867); *Popular Poetical and Dramatic Literature of Great Britain* (1867); *Bibliographical Collections* (1882). He has edited the *Poems of Constable, Lovelace, Herrick*, and other seventeenth and eighteenth century literature.

HEAD, THE VERTEBRATE. See SEGMENTATION OF THE VERTEBRATE HEAD AND BRAIN, in these Supplements.

HEAD-DRESS. See COSTUME, Vol. VI, pp. 453 et seq.

HEADER. See HARVESTING MACHINERY, in these Supplements.

HEADLEY, JOEL TYLER, an American author; born at Walton, Delaware County, New York, Dec. 30, 1813. After graduating at Union College in 1839, he studied theology at Auburn Theological Seminary, and became pastor of a church at Stockbridge, Massachusetts. Ill-health soon obliged him to give up pastoral work. In 1842 he went to Europe, and on his return published *Letters from Italy and the Alps and the Rhine*; after this, numerous works, mostly on historical subjects and popular in character: *Napoleon and His Marshals* (1846); *Washington and His Generals* (1847); *The Adirondacks* (1849), in which he made this region known to the world; *Second War between England and the United States* (1853); *Life of General Hazelock* (1859); *Sacred Heroes and Martyrs* (1865); *Grant and Sherman* (1865); *Great Rebellion* (1866); *Farragut and our Naval Commanders* (1867); *Life of U. S. Grant* (1868); *The Achievements of Stanley and Other African Explorers* (1877). He was assistant editor of the *New York Tribune* in 1846, and in 1855 was elected Secretary of State of New York. Died at Newburg, N. Y., Jan. 16, 1897.

HEADLEY, PHINEAS CAMP, an American author; born in Walton, New York, June 24, 1819; educated to the law; later studied theology, and held pastorates in Adams, New York, and Greenfield, Mas-

sachusetts; wrote historical works similar to those of his brother JOEL TYLER; *Empress Josephine* (1851); *Lafayette* (1856); *Massachusetts in the Rebellion* (1866).

HEALDSBURG, a city of Sonoma County, central California, situated on the Russian River and the San Francisco and North Pacific railroad, 60 miles N. of San Francisco, and 20 miles from the ocean. It has an academy, the Healdsburg College, and a graded school. It is principally engaged in fruit and stock raising, grape-culture and quicksilver-mining. It has manufactories of chairs, baskets and wine. Population 1890, 1,485; 1900, 1,869.

HEALTH, BOARDS OF. A board of health is a commission charged with certain duties and powers for the purpose of protecting or improving the public health. Boards of health in the United States are either national, state or local in their jurisdiction. A national board of health, composed of seven members, is provided for by act of Congress. It has general charge of matters affecting the public health, especially in quarantine matters, and must report to Congress and consult with the various state and local boards when occasion may require. State boards of health are provided for in the various states, to be appointed by the governor, and whose duty extends throughout the state. The duties of these boards may vary in the different states, but they are usually required to supervise generally the matters pertaining to the public health, and collect statistics and report measures to the state legislature for the improvement and protection of public health.

Local boards of health are usually provided for by the general laws of the state, and in cities especially such boards have important duties to perform. When a business is carried on in a city in such a manner as to become a public nuisance and threatens to injure the public health, the board of health usually has the right to abate it. They may prohibit the sale of impure milk and other articles of food, and may be empowered to employ physicians, and may regulate the manner of caring for persons afflicted with contagious diseases. In many matters in which the public health is affected, the board may exercise summary powers for the public benefit, and if it is guilty of gross negligence in the performance of these duties, the members are personally liable for the act. See PUBLIC HEALTH, Vol. XX, p. 97.

HEALY, GEORGE PETER ALEXANDER, an American portrait-painter; born at Boston, Massachusetts, July 15, 1808. He studied for several years in Paris, and painted afterward the portraits of Louis Philippe, Marshal Soult, Lewis Cass, Clay, Calhoun, Daniel Webster, Seward, Pierce, General Sherman, William H. Prescott, H. W. Longfellow, Cardinal McCloskey and Stephen A. Douglas. In twenty years he executed nearly six hundred portraits. In 1851 he completed his large historical picture of *Webster's Reply to Hayne*, which contains 130 portraits, and hangs now in Faneuil Hall, Boston. In 1855 he exhibited at Paris a large picture representing Franklin urging the claims of the American colonies before Louis XVI, besides a series of thirteen por-

traits. To the Philadelphia Centennial Exhibition he sent portraits of Thiers, the Princess of Roumania, Elihu B. Washburn and Lord Lyons. He published his *Reminiscences of a Portrait Painter* shortly before his death, which occurred in Chicago, June 24, 1894.

HEALY, TIMOTHY M., an Irish statesman; member of Parliament; born at Bantry, Ireland, in 1855. He took an active part in the Land League agitation in 1880, and was arrested for a speech at Bantry, but was acquitted. Elected to Parliament without opposition, he took a lively interest in the discussions of the Land Bill of 1881, and obtained the insertion of the clause (since known as "the Healy clause") which excluded the improvements made by tenants from rent. In 1882 he was sentenced to imprisonment for six months for refusing to give bail for good behavior, but was released after four months; in 1884 Healy was called to the Irish bar; in 1888-90 he was one of the Irish leaders brought before the Special Commission; took a prominent part in the struggle against the leadership of Mr. Parnell in 1891; in 1892, and again in 1895, he was returned from North Louth. Healy, with other Irish Land Leaguers, visited America on a lecturing tour in 1881-82. He was one of the founders of the *National Press* of Dublin.

HEARD'S ISLAND, an island in the South Indian Ocean, extending between lat.  $50^{\circ} 2'$  and  $53^{\circ} 14'$  S., and between long.  $73^{\circ} 30'$  and  $72^{\circ} 30'$  E. It is 30 miles long and 10 miles wide, and its highest point, Kaiser Wilhelm Peak, is about 6,000 feet high. The island was discovered by Captain Heard of the American ship *Oriental* in 1853.

HEARING, DEVELOPMENT OF. See SENSE-ORGANS, in these Supplements.

HEARN, LAFADIO, an American author; born at Santa Maura, Ionian Islands, June 27, 1850, of a Greek mother, his father being English; educated in England and France; engaged in journalism in Cincinnati and New Orleans; author of *One of Cleopatra's Nights* (1882); *Stray Leaves from Strange Literature* (1884); *Glimpses of Unfamiliar Japan* (1894), consisting of an account of the marvelous patience, industry, and courtesy of the common people; and *Kokoro* (1896). He now lives in Japan, and is married to a native of that land, where he has been fitly appointed to the chair of English literature in the Imperial University of Tokyo.



LAFADIO HEARN.

HEARNE, a post-village of Robertson County, southeastern central Texas, about three miles E. of the Brazos River, at the junction of the Houston and Texas Central and the International and Great Northern railroads. It ships cotton, grain, hides and stock. Population 1000, 2,129.

HEARSAY-EVIDENCE. See EVIDENCE, Vol. VIII, p. 740.

HEART. See ANATOMY, Vol. I, pp. 899-902; and HEART, DISEASES OF, Vol. XI, pp. 552-554.

HEART'S CONTENT, a port of Newfoundland, beautifully situated on the S.E. side of Trinity Bay, in lat.  $47^{\circ} 50'$  N., long.  $53^{\circ} 20'$  W. It is the landing-place of the Atlantic telegraph cables, extending to Valencia, Ireland, and there are overland wires connecting with St. John's and Cape Ray. It has a fine telegraph building. Most of the inhabitants are engaged in fishing. Population, 900.

HEARTWOOD OR DURAMEN. See BOTANY, Vol. IV, p. 101.

HEATH, FRANCIS GEORGE, an English writer; born at Totnes, Devonshire, Jan. 15, 1843; entered the civil service in 1862, and has taken an active interest in the preservation of forests and in the extension of parks and public squares in London, notably in the enlargement by twenty-four and one half acres of Victoria Park in 1872 and in the preservation of Epping Forest. He has published *The Romance of Peasant Life* (1872); *English Peasantry* (1874); *The Fern Paradise* (1878); *Our Woodland Trees* (1878); *My Garden Wild* (1881); *The Fern Portfolio*, containing colored plates and brief descriptions of all the British ferns (1885); *Sylvan Winter* (1885).

HEATH, WILLIAM, an American Revolutionary general; born in Roxbury, Massachusetts, March 7, 1737. He was active in organizing the militia before the Revolution; was a captain in the Suffolk regiment, of which he afterward became colonel; joined the artillery company of Boston, and was chosen its commander in 1770. In 1774-75 he was a member of the Provincial Congress, and as provincial brigadier-general he performed valuable services in the pursuit of the British troops from Concord, April 19, 1775. He organized and trained the undisciplined forces at Cambridge before the battle of Bunker Hill. Upon the organization of the Continental army he was commissioned a brigadier-general, and stationed at Roxbury with his command; on Aug. 9, 1776, he was made a major-general. In March, 1776, he opposed the evacuation of the city of New York; after the battle of White Plains he took command of the posts in the Highlands; in 1777 had charge of the prisoners of Burgoyne's army at Cambridge. In June, 1779, he commanded the posts on the Hudson with four regiments, and remained in that vicinity till the close of the war. After the war he returned to his farm; was a member of the convention that ratified the Federal Constitution; State Senator in 1791-92; and probate judge of Norfolk County in 1793. In 1798 he published *Memoirs of Major-General William Heath, containing Anecdotes and Details of Skirmishes, Battles, etc., during the American War*. He died in Roxbury, Jan. 24, 1814.

HEATH-FOWL, same as BLACK-COCK. See GROUSE, Vol. XI, p. 223.

HEATHS. See HORTICULTURE, Vol. XII, p. 263; and ERICACEÆ, in these Supplements.

HEATING OF BUILDINGS. See FURNACES, in these Supplements.

HEAVES OR BROKEN-WIND, a disease of horses most common in those of low breed. 12

symptoms are observed most easily when the animal has been severely exercised. At such times the breathing is labored, the expulsion of breath from the lungs being affected by spasmodic efforts; the nostrils are dilated, the eyes blood-shot, and the animal coughs frequently. Little is definitely known about the cause of the disease; some consider that it arises from impurity of the blood, others from a diseased condition of the heart. No method of cure has proved very successful, but the distemper may be relieved by insuring good digestion and not overworking.

HEAVY SPAR. See BARYTES, Vol. III, p. 406.

HEBEL, JOHANN PETER, called the "German Burns"; born at Basel, May 11, 1760. He was educated at Karlsruhe and Erlangen; became professor of ancient languages in the gymnasium at Karlsruhe, later professor of theology and Hebrew, for some time was editor of the *Rheinländische Hausfreund*. He published *Bible Stories* (1824); *Allemanian Poems* (1803). J. G. Schultheiss has written his biography (1831). He died at Schwetzingen, Sept. 22, 1826.

HÉBERT, ANTOINE AUGUSTE ERNEST, a French painter; born at Grenoble, Nov. 3, 1817; studied under Delaroche and D'Angers, and at the school of Fine Arts, in Paris; made commander in the Legion of Honor in 1874; was director of the French Academy, in Rome, in 1866-73, and again in 1885; professor at the Fine Arts in 1882. Among his works are *La Mal' Aria* (1850), now in the Luxembourg; *Portrait du Prince Napoléon* (1853); *Le Baiser de Judas*; *Muse* (1884).

HEBRON, a town and the capital of Thayer County, southeastern Nebraska, on the Little Blue River, and the Burlington and Missouri River and Chicago, Rock Island and Pacific railroads, 55 miles S.E. of Hastings. It is the trade and shipping center of a fertile and well-watered farming and stock-raising region. Fine building-stone is found in the vicinity. Population 1890, 1,502; 1900, 1,511.

HECATOMB, in the worship of the Greeks and in other ancient religions, a sacrifice of a large number of victims; properly, although by no means necessarily, one hundred. As early as the time of Homer it was usual only to burn the legs wrapped up in the fat and certain parts of the intestines, the rest of the victim being eaten at the festive meal after the sacrifice. In Athens the hecatomb was a most popular form of sacrifice, while the Spartans limited the number of victims and sacrifices. In the hecatomb, strictly so called, the sacrifice was supposed to consist of one hundred bulls, but other animals were frequently substituted.

HECKER, FRIEDRICH KARL FRANZ, a German revolutionist; born at Eichersheim, Baden, Sept. 28, 1811. He studied law at Heidelberg; began practice at Mannheim; in 1842 was elected to the Chamber of Deputies of Baden, and became a prominent member of the Opposition, later a leader of the extreme Republican and Socialist party. When the revolution of 1848 broke out he was active in its support, and endeavored to change the preliminary convention into a permanent republican assembly. Failing in this, he put himself at the head of an

army of artisans, with the idea of getting control of some of the smaller German governments. He was beaten by the Baden soldiery at Kaudern, May 20, 1848, and had to retreat into Switzerland, and from there emigrated to America, settled as a farmer near Belleville, Illinois, and became a citizen of the United States. When the Civil War broke out he served in General Frémont's division as colonel of a regiment raised by himself, and afterward as brigadier-general under General Howard. He died in St. Louis, Missouri, March 24, 1881.

HECKER, ISAAC THOMAS, an American clergyman, founder of the Paulists; born in New York City, Dec. 18, 1819. In 1843 he joined the Brook Farm Community, near Boston, where for nine months he baked the bread eaten by the members. In 1845 he became a Roman Catholic; went to Germany to study for the priesthood; joined the Redemptorist Fathers in Belgium in 1847, and was ordained priest in London in 1849 by Cardinal Wiseman.



ISAAC T. HECKER.

After being released from connection with the Redemptorists, he founded in 1858 the new congregation of the missionary priests of St. Paul (the Paulist Fathers) in New York City. The members take no vows, and any priest can leave the order when he chooses. Hecker established *The Catholic World*, a monthly periodical, in 1865; wrote the *Questions of the Soul*; *Aspirations of Nature*; and a pamphlet on *Martin Luther* (1883). Died in New York City, Dec. 22, 1888.

HECKEWELDER, JOHN GOTTLIEB ERNST, an American Moravian missionary to the Indians; born at Bedford, England, March 12, 1743. His father brought him to Pennsylvania in 1754, where he was afterward apprenticed to a cooper. In 1762 he visited the Indian tribes on the Ohio with Christian F. Post, a colonial Indian agent, and in 1771 he became a missionary to the Delaware Indians. In 1792 and 1793 he accompanied the United States commissioners sent to make treaties with Indian tribes near the Great Lakes. After staying in Ohio for some years as postmaster, justice of the peace, and also of the court of common pleas, he retired to Bethlehem, Pennsylvania, where he studied the languages and customs of the Indians, especially the Delawares, and wrote a *History of the Indians of Pennsylvania* (1818); *Narrative of the Mission of the United Brethren Among the Delaware and Mohican Indians* (1820); and a collection of *Names which the Delaware Indians Gave to Rivers, Streams and Localities within the States of Pennsylvania, New Jersey, Maryland and Virginia, with Their Significations* (1822). A *Life of Heckewelder* was written by Edward Rondthaler (1847). Died at Bethlehem, Pennsylvania, Jan. 21, 1823.

HECKLING. See LINEN, Vol. XIV, p. 664.

HECLA, MOUNT. See ICELAND, Vol. XII, pp 616, 617.

HECTIC FEVER, the name given to the fever which occurs in connection with certain wasting diseases of long duration. It is one of the most serious and constant symptoms of consumption, and seems to be directly related to the progressive emaciation which marks the course of that malady. In the morning the patient's temperature may be normal, but toward evening or after eating he grows hot and flushed, and there is a preternatural vividness of expression, which, with the heightened color, sometimes gives a very fallacious impression of health. The patient retires to bed, has uneasy sleep, and wakens in the middle of the night or toward early morning, bathed in cold perspiration, and in a state of extreme languor. The same exhausting cycle repeats itself day after day. The only radical way of treating the fever is to cure the disease on which it depends.

HECTOCOTYLUS OR HECTOCOTYLIZED ARM. See MOLLUSCA, Vol. XVI, p. 675.

HECTOR, MRS. ANNIE, a British novelist, writing under the pseudonym of MRS. ALEXANDER; born in Dublin in 1825. Among her novels are *The Heritage of Langdale* (1877); *The Admiral's Ward*; *Her Dearest Foe* (1883); *Ralph Wilton's Weird* (1884); and *The Cost of Her Pride* (1898).

HEDBERG, FRANS TEODOR, a dramatic author; born in Stockholm, March 2, 1828; was apprenticed to a wig-maker; in 1849 went on the stage; left the stage in 1854, and began writing plays; in 1862 was made professor of declamation at the Royal Theater of Stockholm; in 1871 intendant in the same theater; in 1881 director of a theater at Göteborg. Among his plays are *My Friend the Lieutenant* (1853); *When You Have No Money* (1854); *Glanskis*; *The Vikings*; and *The Wedding at Ulfasa* (1865). He also published *Poems* (2 vols., 1866), and in 1884 biographical works on the Swedish theater and opera.

HEDDING COLLEGE, at Abingdon, Knox Co., Ill., a co-educational establishment, controlled by the Methodist Episcopal Church, was organized in 1855, and in 1898 had 12 instructors, 200 students, and a library of 2,000 volumes. Its productive funds amount to \$30,000; and its total annual income, including tuition fees, is \$6,400.

HEDDLE OR HEALD, an implement used in weaving. See WEAVING, Vol. XXIV, pp. 464-467.

HEDGE. See ARBORICULTURE, Vol. II, p. 319.

HEDGE, FREDERIC HENRY, an American clergyman and author and scholar of note; born at Cambridge, Massachusetts, Dec. 12, 1805; in charge of George Bancroft, he was educated in Germany. On his return to America he studied theology at the Cambridge Divinity School; became pastor of the Unitarian church at West Cambridge in 1829; in 1835, of a church at Bangor, Maine; in 1850, after spending a year in Europe, pastor of the Westminster church at Providence, Rhode Island, from which he removed to Brookline, Massachusetts, in 1856. In 1858 he became lecturer on ecclesiastical history in Harvard College, and edited at the same time the *Christian Examiner*. In 1872 he assumed the professorship of the German language in the same college. Dr. Hedge published *The Prose-*

*Writers of Germany* (1848); *Reason in Religion* (1865); *The Primæval World of Hebrew Tradition* (1870); *A Christian Liturgy for the Use of the Church*, etc. He also wrote hymns for the Unitarian Church and published translations from the German poets. Died at Cambridge, Massachusetts, Aug. 21, 1890.

HEDGE—MUSTARD, a name given to species of *Sisymbrium*, a genus of plants of the family *Cruciferae*, annual or rarely perennial herbs, with various foliage, small yellow or white flowers, and long roundish or four- or six-angled pods. The common hedge-mustard (*S. officinale*) was once employed in medicine. It is said to be a diaphoretic and expectorant, and has a mild pungency. It is an annual, hairy plant, sometimes two feet high, branched with runcinate leaves, very small yellow flowers, and pods closely pressed to the stalk.

HEDGE—SPARROW. See SPARROW, Vol. XXII, p. 369.

HEDJAZ EL HEJAZ OR HIJAZ, a nearly barren district in Arabia noted as the pathway of the pilgrimage to Mecca. See ARABIA, Vol. II, pp. 236-253.

HEDONISM, philosophy of the pursuit of pleasure. See ETHICS, Vol. VIII, pp. 585, 586.

HEGIRA OR HIJRA. See MOHAMMEDANISM, Vol. XVI, pp. 545-551; and CHRONOLOGY, Vol. V, p. 717.

HEIBERG, PETER ANDREAS, a Danish political and dramatic writer; born at Vordingborg, Denmark, Nov. 16, 1758; educated at the University of Copenhagen, and lived in the same city as translator and political writer until 1799, when he was banished for a seditious publication. Went to Paris, and was employed by Napoleon as translator in the department of foreign affairs. Among his writings are *Heckingborn* and *The Voyage to China*, dramas; *Historical and Critical Summary of the Danish Monarchy* (1820); *The Life of a Dollar Bill*. Died in Paris, April 30, 1841.

HEIDENHAIN, RUDOLPH PETER HEINRICH, a German physiologist; born at Marienwerder, Jan. 19, 1834; studied at Königsberg, Halle and Berlin; private instructor at Halle in 1857; professor of physiology and histology at Breslau in 1859. He has published *Studies in Physiology* (1856); *The So-called Animal Magnetism* (1880); *Vivisection applied to the Art of Medicine* (1884). See MAGNETISM, Vol. XV, p. 278. He died Oct. 14, 1897.

HEILBLUTH, FERDINAND, a German painter, born in Hamburg, but moved to Paris and became a citizen of France, and later chevalier of the Legion of Honor; in 1881, officer. Among his works are *Le Mont-de-Piété* (1861), now at the Luxembourg; *Spring*; *The Autumn of Love* (1871); *The Antechamber of the Cardinal*; *By the Thames* (1878).

HEIMDAL, in Scandinavian mythology, the god of watchfulness. See AESIR, Vol. I, p. 211.

HEINSIUS, ANTHONIUS, a Dutch statesman, born at Delft, Dec. 22, 1641. He studied law at Leyden, became the friend and supporter of Wil-

liam of Orange, and when that prince ascended the English throne, was elected Grand Pensionary of Holland, 1689, and re-elected every five years thereafter until his death. While in office he controlled the political policy of Holland, and was instrumental in the formation and maintenance of the grand alliance of England, Holland, Denmark and the German states against Louis XIV. He was the last of the allies to sign the treaty of peace at Utrecht. He died Aug. 13, 1720.

HEINTZELMAN, SAMUEL PETER, an American soldier, born at Manheim, Lancaster County, Pennsylvania, Sept. 30, 1805. He graduated at West Point in 1826, spent several years in border service as lieutenant, served during the Mexican War as captain, and on the 9th of October, 1847, was brevetted major. After serving in California against the Indians and on the Rio Grande against Mexican marauders, he was brevetted lieutenant-colonel in May, 1861, and was made inspector-general of the United States forces with headquarters at Washington. Afterward he commanded a division of McDowell's army at the battle of Bull Run, and was wounded; in March, 1862, was in command of the Third Army Corps; took part in the battles of Williamsburg and Fair Oaks; in the seven days' fighting around Richmond; in the second battle of Bull Run; and commanded the defenses of Washington. After the war he did duty in New York and Texas as colonel of the Seventeenth Infantry. In April, 1869, he was placed on the retired list with the rank of major-general. He died in Washington, District of Columbia, May 1, 1880.

HEISS, MICHAEL, a German evangelist; born in Bavaria, April 12, 1818; removed to the United States in 1842 and acted as a missionary priest in Wisconsin for several years; in 1846 founded the Church of St. Mary, in Milwaukee; in 1868, became bishop of La Crosse, Wisconsin; in 1880 he was made coadjutor to the archbishop of Milwaukee, with right of succession, and in 1881 succeeded to the see. Among his published works are *Über die vier Evangelien* and *Über die Ehc.* He died March 26, 1890.

HEL, in Norse mythology, the goddess of the dead, and daughter of the evil-hearted Loki. The All-father hurled her down into Niflheim, and gave her authority over the lower world. She was of fierce aspect, and to her were assigned the characteristics of insatiable greed and pitilessness. After the diffusion of Christianity the ideas personified in Hel gradually merged, among the races of Scandinavian and German descent, in the local conception of a hell, or dark abode of the dead.

HELENA, a city and the capital of Phillips County, central eastern Arkansas, situated on the Mississippi River, 67 miles below Memphis, Tennessee, and on the Arkansas Midland and the St. Louis, Iron Mountain and Southern railroads. It is the seat of Southland College, and has gas and electric lights, and a street-railway system. It has saw-mills, cottonseed-oil mills, and foundries. Pop. 1890, 5,189; 1900, 5,550.

HELENA, the capital of Montana and of Lewis and Clarke County, situated among foot-hills in the Prickly Pear Valley, 14 miles W. of the Missouri River, and with the Rocky Mountains rising behind the city to the south. The Great Northern and the Northern Pacific railroads pass through Helena, and the city is connected with the Canadian Pacific and Union Pacific roads, and by branch lines with several mining-camps. Many of the streets are wide and straight, shaded with rows of cottonwood trees, and faced with handsome residences and business premises, and well lighted with gas and electricity. There are six street-railways. A board of trade was organized in 1887. There are 34 graded schools, a high school and a number of private and parochial schools. Montana University, opened in 1890, is located outside the city. Charitable institutions are numerous, and nearly all religious denominations are represented by the churches of the city. It is active in manufacturing, having quartz, flour and lumber-mills, foundries, machine-shops, planing-mills, carriage and harness and other factories. Gold was found here in 1864, and the camp was known as Last Chance Gulch until December of that year, when it received its present name. There are also ruby and sapphire fields in the vicinity. Population 1890, 13,834; 1900, 10,770.

HELENUS, son of Priam and Hecuba, and gifted with prophetic powers. He fought against the Greeks in the Trojan War, but later deserted to them, some say beguiled by Ulysses, others because, at the death of Paris, Helen was given to Deiphobus and not to himself. The Greeks turned his gift of prophecy to good account, and he is said to have suggested the construction of the wooden horse and the theft of the Palladium. At the close of the war he became the slave of Pyrrhus, and it was due to his advice that Pyrrhus did not accompany the other Greek chieftains homeward by sea, but went by land instead to Epirus. Upon the death of Pyrrhus, Helenus became king of a portion of Epirus, and married Andromache, the wife of Hector. He was visited by Aeneas, whose future course he prophesied. Alexander the Great claimed descent from Helenus.

HELIANTHUS, a species of sunflower. See HORTICULTURE, Vol. XII, p. 251.

HELICIDÆ (Gr., *helix*, "a spiral"), a large family of terrestrial, air-breathing (pulmonate) gasteropods, of which snails are familiar examples, found in almost all parts of the globe save the Arctic regions. The genus was originally quite extensive, including nearly all land-shells, but has now become greatly restricted. See also MOLLUSCA, Vol. XVI, p. 660.

HELIGOLAND ("Holy Land"), an island 36 miles N.W. of the Elbe mouth. It consists of a rock two hundred feet high, on which are a village and a light-house. It is the resort of bathers from Hamburg. During 1890 the announcement of its proposed transference, under the terms of the Anglo-German agreement respecting Africa, from British to German rule, came as a complete surprise

to the public of both countries, and various opinions were speedily elicited as to the propriety of the step contemplated. In England the value of the island as a naval station was strongly insisted upon. It was declared that the Heligolanders themselves were bitterly averse to the change, and Lord Salisbury was severely criticised in some quarters for not having ascertained more carefully their views upon the subject. The protests, however, proved unavailing, and on August 9th the island was formally handed over to Germany, the ceremony being followed by the visit of the German Emperor on the next day, when a proclamation was read in which his Majesty promised the utmost care for the rights and wishes of the islanders, and announced that all living males would be exempt from compulsory military and naval service, to which they have a remarkable abhorrence. The revenue of the island annually is slightly over \$40,000, and the expenditure over \$35,000. See also HELIGOLAND, Vol. XI, pp. 630-632.

HELIOCHROMOSCOPE, a photographic apparatus for reproducing objects in colors. That exhibited before the Franklin Institute in Philadelphia in 1893, by T. E. Ives, contains an arrangement of mirrors. Three pictures representing the effect upon the three fundamental color-sensations are made by a single exposure on a single sensitive plate, and from a single point of view. The mirrors serve to recombine the three photographs in such manner that the photographic color-record is translated into color again.

HELIOMETER. See MICROMETER, Vol. XVI, pp. 250-252.

HELIOS. See APOLLO, Vol. II, pp. 185, 186.

HELIOSTAT. See HELIOGRAPHY, Vol. XI, p. 633.

HELIOTROPE OR HELIOSCOPE. See GEODESY, Vol. X, p. 165.

HELIOTROPISM, a term in physiological botany applied to the irritability displayed by growing parts of plants and other motile members to the direction of incidence of the rays of light. If the apex of the member is directed toward the source of light, it is said to be *positively heliotropic*, as is the case with most primary stems; if the apex is directed in the opposite direction, the member is said to be *negatively heliotropic*, as in many roots.

HELIOTYPE. See PHOTOGRAPHY, Vol. XVIII, pp. 832, 833.

HELIOZOA, fresh-water animalculæ. See PROTOZOA, Vol. XIX, pp. 844, 845.

HELIUM. Nitrogen from the air having been shown to contain a considerable proportion of argon, it occurred to Professor Ramsay that the "nitrogen" found in certain minerals might also be mixed with a similar proportion of the new gas. This expectation was fulfilled, and at the same time the surprising discovery was made that several minerals gave off a gas which was neither nitrogen nor argon, but something entirely new. Thus cleveite had been thought to give nitrogen on boiling with dilute sulphuric acid. The gas,

however, was found to possess an entirely different spectrum, and showed a brilliant orange line corresponding to the line D<sup>3</sup> of the solar spectrum. This line had long been observed in the spectrum of the sun, and the unknown substance which produced it had been called *helium*. This name, was, therefore, at once conferred on the new element. The same gas has also been extracted from other minerals, such as bröggerite, samarskite, and fergusonite, and from the mineral water of Wildbad. Helium is one of the lightest known gases, having the density of 0.139, air being unity, and is thus twice the density of hydrogen. The gas, like argon, does not seem to enter into chemical combination. Its molecules consist of single atoms; and its atomic weight is 4. Crookes has measured 79 lines in its spectrum, of which 27 seem to be identical with known solar lines. In 1898 Professor Dewar succeeded in liquefying helium, when its boiling-point was found to be about the same as that of hydrogen.

HELLBENDER (*Cryptobranchus alleghaniensis*), a large, voracious salamander, common in rivers of the Ohio system. It is slate-colored, about twenty inches long, and with no external gills. It is greatly feared by many people, but is perfectly harmless. The generic names *Menopoma* and *Protonopsis* are used in some systematic works. The popular names of mud-puppy, water-dog, mud-devil, etc., are given to the animal in common with similar forms.

HELL-DIVER. See GREEL, Vol. XI, p. 79.

HELLENES, ancient Greeks. See GREECE, Vol. XI, pp. 90-93.

HELLER, STEPHEN, a German pianist and musical composer; born at Pesth, May 15, 1814. He made his *début* as a pianist when only nine years of age, and before he was sixteen had played in many of the principal cities of Europe. In 1830 he settled in Augsburg, and began the study of composition. In 1838 he removed to Paris, where he occupied himself with composing and teaching until his death, which occurred Jan. 14, 1888. His works are distinguished by originality and refinement.

HELL GATE, named by the Dutch settlers of New York *Helle Gat*, is a pass in East River, between New York City and Long Island, formerly very dangerous to vessels from its numerous rocks and its rapid currents. These rocks and reefs were in mid-channel, and projected also from several small, rocky islands. The largest were known as the Gridiron, Flood Rock, Hen and Chickens, Negro Head, Bread and Cheese, Hallett's Point, Way's Reef, Pot Rock, Frying Pan, Middle Reef, etc. In 1851 attempts were made to blast away the obstructions, and in these operations Maillefert's process of surface-blasting was employed. This consisted in placing charges of gunpowder, usually 125 pounds, on the surface of a rock and exploding the powder by means of an electric current. The rocks thus operated upon were Pot Rock, Frying Pan, Way's Reef, Baldheaded Billy, Sheldrake Rock, and Diamond Reef. On all of them the depth of the water was increased, in some cases only two feet, and

in others as much as ten feet. These improvements consumed over seventy-four thousand pounds of gunpowder, and cost about fourteen thousand dollars. The money was furnished by New York City. In these operations the broken material was not dredged or otherwise cleared away.

The depths obtained were not sufficient for first-class vessels. Besides, a number of other obstructions remained in the channel. The United States government, therefore, appropriated twenty thousand dollars in 1852, and Major Frazer, United States engineer, continued the surface-blasting on Pot Rock in the same year, thereby increasing the depth of the water over this rock from eighteen to twenty feet. By this time it was deemed necessary to adopt other methods of working. Drilling under water through diving-bells was impossible, because the current runs too fast and the space was too small. The question arose, How can this work be done successfully? No satisfactory plan was devised until 1866, when General John Newton, United States Engineer, proposed drilling from a fixed platform through tubes reaching to the surface of the rocks. Congress made now sufficient appropriations for the work.

In 1869 Newton used a floatingscow having a central opening of 32 feet diameter, through which a large hemispherical iron bell, open both at top and bottom, was lowered to the rock below. This dome-like caisson, made of boiler-iron, afforded a framework for supporting 21 drill-tubes. Drills weighing from six hundred to nine hundred pounds worked through these tubes. The bell had legs which could be let out or drawn in to fit the rock. Cams were used to hold the legs in place. After the drilling was completed the drill-holes were filled by a diver, who inserted charges of nitroglycerine and made the electrical connections with the fuses. After this the scow was floated away and the blasts fired. The broken rock was removed by means of a steam-grapple.

In 1871 Newton used a steam-drilling scow on the Diamond Reef. He now drilled holes from 7 to 13 feet deep and 4 inches in diameter. He fired them with charges of from 30 to 55 pounds of nitroglycerine. In 1871 he operated in like manner on Coenties Reef; in 1872, on the Frying Pan and Pot Rock. In that year the scow was struck 16 times by colliding vessels, and four of the latter were sunk by it. One vessel was drawn under the scow, and carried off its dome; but the dome was afterward recovered in a damaged condition. In 1874 Newton reduced Way's Reef from 17 feet to a depth of 26 feet.

The most difficult problem was the removal of the reef at Hallett's Point. To accomplish this, in 1869 he sank a large shaft on shore. From this shaft 41 radial and 11 concentric galleries of various cross-sections were driven under the reef. The length of all these galleries together amounted to nearly one and one half miles. Diamond drills, Ingersoll drills, Burleigh drills and hammer-drills were all used in this work. The excavations were

completed in June, 1875. Then holes were drilled in piers and roofs for the charges. From Sept. 11, 1876, till the 20th of the same month was occupied by charging the holes. Twenty-three distinct galvanic batteries, aggregating 960 cells of zinc and carbon, were arranged to fire 160 fuses each; 3,680 mines were connected in continuous series with a lead and return wire, so that the circuits of all could be closed with one circuit-closer—i.e., by pressing down a button. After everything was ready the mines were tamped by water run in through a syphon, and on Sunday, Sept. 24, 1876, at 2.50 P.M., they were fired, without any hurtful shocks to surrounding objects. The water was thrown up to a height of 123 feet. The total expense of this blast was \$81,092.

Flood Rock, situated in mid-channel, was still projecting above water, and constituted a dangerous reef. Work tending to its removal began June, 1875, by sinking a shaft 10 feet by 20 feet down through the rock. During the following year the mine was filled with water. Want of appropriations caused several suspensions, which added considerably to the cost of the work, in consequence of the pumping required to free the mine from the water flowing into it by some large seams. In 1884 the undermined area covered 9 acres. The total length of the galleries, 10 feet square, was 21,670 feet. The drill-holes for breaking up the roof and columns amounted to a total length of 113,000 feet, or over twenty miles. For charging the drill-holes, cartridges 2 feet long were inserted and held in place by 4 small wire legs. These cartridges were filled with "rackarock," a mixture of 79 per cent of finely-ground chlorate of potash with 21 per cent of dinitrobenzole. After filling the drill-holes with several rackarock cartridges, a dynamite cartridge, 15 inches long, with a fulminate of mercury exploder, was inserted. The mine was fired by primary charges of dynamite placed at intervals of 25 feet along the galleries, lashed to some timbers. Their explosion produced a concussion strong enough to ignite the fulminate primers in the charges of rackarock. By this "sympathetic" method the entire mine, containing over 120 tons of rackarock and 42,000 pounds of dynamite, was exploded simultaneously, on Oct. 10, 1884. The battery contained 60 bichromate cells, connected together in series. When the electric contact was made, a dull report was heard, the earth shook for a considerable distance around and an immense mass of water was thrown some 200 hundred feet up into the air. But no damage was done except the breaking of a few dozen panes of glass, and shaking down some loose brick and plaster in Astoria. No severe shock was felt anywhere. Yet the entire roof of the mine was shattered, and about 500,000 tons of rock were loosened. The total expense of this blast was \$106,509.

Immediately after this explosion dredging was commenced with the government scow, but in October, 1885, a contract was let for the removal of 30,000 tons of loosened rock, and afterward other similar contracts were let. About 120 tons

were removed daily for a considerable time. But there are some of the rocky obstructions yet to be removed, inasmuch as the mean low-water depth is not quite 26 feet over the Diamond Reef, Coenties Reef, a reef near the North Brother's Island, and the Pilgrim Rock, which have been included in the projected improvements. Both the main and eastern channels, however, now afford passages wide and deep enough for the largest vessels.

**HELLGRAMMITE-FLY**, a neuropterous insect (*Corydalus cornuta*). The larvæ are much used as fish-bait, especially for bass, and have various local names, such as dobsons, crawlers, etc.

**HELLMANN, JOHANN GEORG GUSTAV**, a German meteorologist; born in Silesia, July 3, 1854; studied at Breslau, Berlin, and Göttingen, and afterward spent two years in Spain, making a study of the climate of the country; entered the Meteorological Department of the German government, and in 1880 was made assistant at the Royal Prussian Meteorological Institute. He is on the staff of the *Meteorologische Zeitschrift*, and has written a work on meteorology.

**HELMET-SHELL**, the shell of a mollusk belonging to the genus *Cassis*, a thick, heavy shell, with bold ridges, a short spire, and a long aperture, the outer lip toothed, the canal recurved. There are numerous species, most of them found in tropical seas, some in the Mediterranean. The shells are made up of differently colored layers, and are much used for the manufacture of cameos. (See also *MOLLUSCA*, Vol. XVI, p. 649.)

**HELMHOLTZ, HERMANN LUDWIG FERDINAND VON**, a German physiologist and physicist, born at Potsdam, Prussia, Aug. 31, 1821. After studying medicine in the Military Institute at Berlin, and being attached for a time to the staff of one of the public hospitals there, he returned to his native town as an army surgeon. In 1848 he was appointed professor of anatomy in the Academy of Fine Arts at Berlin; in 1850 professor of physiology and pathology at Königsberg; and in 1855 was appointed to



H. L. F. VON HELMHOLTZ.

the chair of anatomy and physiology at Bonn, whence he removed, in 1858, to Heidelberg, where he filled the chair of physiology. He was afterward appointed professor of physics at Berlin. The works of Professor Helmholtz have reference principally to the physiological conditions of the impressions on the senses. Among those most deserving of notice are *On the Conservation of Energy* (1847); *Manual of Physiological Optics* (1856); and *Theory of the Impressions of Sound* (1862). His *Popular Lectures on Scientific Subjects* were published in London in 1873, and

his work on *Sensations of Tone as a Physiological Basis for the Theory of Music* appeared in 1875. In 1883 a patent of hereditary nobility was conferred upon him by King William, and in 1887 he was put at the head of the Institute of Charlottenburg. He died in Berlin, Sept. 8, 1894.

**HELMUND OR HALMARD**, a river of Afghanistan, rising in the Unai Pass between the Hoh-i-Baba and the Pugman Mountains. It flows southwest and forms the boundary of Baluchistan for 50 miles, turns north and forms the Persian boundary for 30, then flows on, emptying into the salt lake Dek-i-Tir. Its length is estimated at 650 miles. The country through which it flows is generally arid, especially about the upper part of the course, though the immediate river valley is fertile and cultivated.

**HELODERMA**. See *LIZARD*, Vol. XIV, p. 735. See also *GILA MONSTER*, in these Supplements.

**HELOS**, a town in Laconia. It is said by some that the Helots, a slave class among the Spartans, got their name from this place, being originally the Achæan inhabitants of the town, reduced to slavery by their Doric conquerors. The derivation is doubtful.

**HELVETIC REPUBLIC**. See *SWITZERLAND*, Vol. XXII, pp. 793, 794.

**HELVETH**. See *CÆSAR*, Vol. IV, p. 636.

**HEMATITE OR HÆMATITE**, ores of iron. See *MINERALOGY*, Vol. XVI, p. 385.

**HEMIBRANCHII**, an order of fishes characterized by peculiar skeletal arrangements. In the shoulder-girdle a single bone unites the largest bone (proscapula) with the skull. The bones of the branchial apparatus are reduced. The sticklebacks are the best-known members of the order.

**HEMICRANIA**. See *NEURALGIA*, Vol. XVII, p. 364.

**HEMIPLEGIA**. See *PARALYSIS*, Vol. XVIII, p. 255.

**HEMITRIPTERIDÆ**, a family of fishes belonging to the mailed-cheeked group. Two representatives occur along the coasts of the United States, the deep-water sculpin and the sea-raven.

**HEMLOCK OR HEMLOCK-SPRUCE**. See *FIR*, Vol. IX, p. 224.

**HEMP CROP IN THE UNITED STATES**. See *AGRICULTURE*, in these Supplements.

**HEMPSTEAD**, a village of Queens County, southern New York, in Hempstead township, situated on the Long Island railroad, 21 miles E. of New York City. It has Hempstead Institute, public halls, a seminary and many fine residences. The township of Hempstead is bounded on the south by the Atlantic Ocean, and includes Rockaway, a popular bathing-place. It has a few factories, but it is chiefly a residence place, many New York business men having handsome residences here. Population 1900, 3,582.

**HEMPSTEAD**, a city and the capital of Waller County, southeastern Texas, on two branches of the Houston and Texas Central railroad. It has a cotton factory, and manufactures cotton-seed.



oil. The surrounding country is high and salubrious, and produces, chiefly, cotton and corn. Population 1890, 1,671.

**HEMSLEY, WILLIAM BOTTING**, a British botanist; born Dec. 29, 1843, in Sussex, England. His father was a gardener, and as a boy he got a taste for botany. In 1860 he entered the Kew Herbarium on probation, and in 1863 received a regular appointment; in 1883 was appointed assistant for India in the Kew Herbarium, and in 1890 promoted to principal assistant. He is author of a *Handbook of Hardy Trees* (1873); *Diagnoses Plantarum Mexicanarum et Centrali-Americanarum* (1878-79); one of the authors of the *Biologia Centrali-Americana* and of the botanical reports of the *Challenger* expedition to explore the deep seas in 1872-76.

**HENDERSON**, a city and the capital of Henderson County, western Kentucky, on the Ohio River, 212 miles S.W. of Louisville, on the Louisville and Nashville and the Ohio Valley railroads. It has car-works, wagon and carriage factories, tobacco factories, cotton-mills and distilleries. Population 1890, 8,835; 1900, 10,272.

**HENDERSON**, a borough and the capital of Sibley County, southern Minnesota, on the Minnesota River, 43 miles S.W. of Minneapolis, on the Chicago, St. Paul, Minneapolis and Omaha railroad. It has some steamboat traffic, flouring and grist mills, and is a shipping-point for farm produce. Population 1900, 904.

**HENDERSON**, a town and the capital of Vance County, central northern North Carolina, 36 miles N. of Raleigh, on the Seaboard Air Line and the Southern railroads. It is in the Golden Tobacco region, and cotton is also an important export. It has tobacco warehouses and factories, and a canning factory. Several academies are located here. Population 1890, 4,191; 1900, 3,746.

**HENDERSON**, a town and the capital of Chester County, southwestern Tennessee, 15 miles S.E. of Jackson, on the Mobile and Ohio railroad. It is a farming center, and ships corn, cotton, fruit, cattle and hogs. Population 1880, 493; 1890, 1,069.

**HENDERSON**, a town and the capital of Rusk County, central eastern Texas, on the International and Great Northern railroad. It is the seat of Henderson College. It is in an agricultural and fruit-growing section. Population 1890, 1,536.

**HENDERSONVILLE**, a town and the capital of Henderson County, western North Carolina, 20 miles S. of Asheville, on the Hendersonville and Brevard and the Southern railroads. It ships vegetables and hay, raised extensively in the vicinity. It is the seat of Judson (Baptist) College and of an academy. Population 1880, 554; 1890, 1,216; 1900, 1,917.

**HENDRICKS, THOMAS ANDREWS**, an American statesman; born near Zanesville, Ohio, Sept. 7, 1819. He graduated at South Hanover College, Indiana, in 1841; studied law at Chambersburg, Pennsylvania; was admitted to the bar there in 1843; practiced law at Shelbyville, In-

diana; in 1850 was elected to the state convention to revise the constitution of Indiana; from 1851 to 1855 was a member of Congress, after which President Pierce appointed him commissioner of the United States general land office. In 1863 Mr. Hendricks was elected to the United States Senate from Indiana, and was one of the leaders on the Democratic side. In 1872 he became governor of Indiana, and after the expiration of his term continued to practice law at Indianapolis until 1884, when he was unanimously nominated for Vice-President on the Democratic ticket. In November following he was elected, but lived to serve only a few months of his term, dying at Indianapolis, Nov. 25, 1885.

**HENGEST OR HENGIST**. See ENGLAND, Vol. VIII, p. 269.

**HENLEY, WILLIAM ERNEST**, a British poet, critic and dramatist; born at Gloucester, England, in 1849, and educated in the same city. After a period of illness, during which he wrote *In Hospital: Rhymes and Rhythms*, he began writing for the London magazines, and in 1877 was one of the founders as well as editor of *London*, to which he contributed much of his early verse. For a time he was editor of the *Magazine of Art*, and in 1889 became editor of the *Scots Observer*, of which, under its present title, the *National Observer*, he is still the chief. Subsequently he became a contributor to the *Athenaeum* and the *Saturday Review*, from the pages of which have been made up a volume of literary and critical articles published under the title of *Views and Reviews*. He is also well known as a poet and dramatist, having collaborated with the late Robert Louis Stevenson, the novelist, in the publication of a volume of plays, and won the ear of many admirers by his spirited verse in the issue of his *Song of the Sword*. He is, moreover, the editor of two volumes of heroic English verse, entitled *Tudor Translations* and *Lyra Heroica*, as well as of an *Anthology of English Prose*, in conjunction with Mr. C. Whibley. His latest literary enterprise is the editing, in concert with Mr. T. F. Henderson, of the Centenary edition, in four volumes, of Robert Burns's poetry, with an essay by Dr. Henley on the life and genius of the poet. Dr. Henley was a man of much learning, an accomplished journalist and an acute critic. Few modern men of letters were so well equipped as he for the everyday work of an intellectual toiler, and he possessed a forceful and attractive literary style, which invests all he wrote with a peculiar charm. In 1893 Mr. Henley received the honorary degree of LL.D. from St. Andrew's University, and was editor of *The New Review* from 1894 till it ceased to exist in 1898.

**HENLOPEN, CAPE**, a cape in Sussex County



THOMAS A. HENDRICKS.

Delaware, at the entrance to Delaware Bay, 13 miles S.S.W. of Cape May. It has a lighthouse, showing a fixed white dioptric light of the first order, 128 feet above sea-level.

**HENNEPIN, LOUIS**, a French explorer of America; born at Ath, Belgium, in 1640. He entered the order of Recollets of St. Francis, and was employed by his brethren to solicit alms at different places—among others, at Dunkirk and Calais, where the stories related by the sailors stimulated his desire to visit foreign countries. Afterward he traveled in Germany and Italy, and was regimental chaplain at the battle of Seneffe, between the Prince of Condé and William of Orange. In 1673 he was ordered to Canada, where he preached for some time at Quebec, and founded a convent at Fort Frontenac. Father Hennepin went to Niagara with La Salle's expedition (see LA SALLE, Vol. XIV, pp. 318, 319). After building Fort Crève Cœur, at the headwaters of the Illinois, La Salle returned to Canada, while Hennepin set out with two men in a canoe in 1680, descended the Illinois to its mouth, and, after sailing up the Mississippi River for some weeks, fell into the hands of a party of Sioux Indians, who carried him and his men to their country. Here he discovered and named the Falls of St. Anthony. He spent eight months among the savages. Then Daniel Greysolon du Lhut, who had come by way of Lake Superior, rescued him, and enabled him to reach Green Bay by way of the Wisconsin River. Hennepin returned to Quebec in April, 1682, and soon afterward returned to France, where he published his *Description of Louisiana, Recently Discovered to the Southwest of New France* (1683). He was appointed guardian of the Convent of Renty, in Artois, but he soon withdrew to Holland. After laying aside his religious dress he lived in England, where he published his *New Discovery of a Vast Country in America* (1697). His last work was *New Journey in a Country Greater than Europe, between the Arctic Ocean and New Mexico* (1698). His works are invaluable to the historian, but full of exaggerations. He died in Utrecht, Holland, in 1706.

**HENNEPIN CANAL.** See CANAL, in these Supplements.

**HENNER, JEAN JACQUES**, a French painter; born in Bernwiller, Alsace, March 5, 1829; entered the School of Fine Arts in 1848; decorated with the Legion of Honor in 1873; made an officer in 1878; elected to the Academy of Fine Arts in 1889. Among his works are *La Chaste Suzanne*, which is in the Luxembourg; *Alsacienne* (1870), presented to M. Gambetta by a number of Alsatian ladies; *Madeleine dans le Désert* (1874); *Le Christ Mort* (1878); and *Pietà* (1891).

**HENNESSY, HENRY**, an Irish physicist; born in Cork, Ireland, March 19, 1826; became a civil engineer, and pursued the study of natural science and mathematics at the same time; in 1855, became professor of physics in the Roman Catholic University of Ireland; in 1874, professor of mathematics in the Royal College of Science. He wrote *The Study of Science in its Relations to Individuals*

and *Society* (1858); *Relations of Science to Modern Civilization* (1862); and more than eighty papers on miscellaneous scientific subjects, published in the reports of the Royal Society, the Royal Irish Academy and the Paris Academy.

**HENNINGSEN, CHARLES FREDERICK**, a British military adventurer and author; born in England, of Swedish parents, in 1815. He joined the Carlist army in Spain in 1834, and became colonel of cavalry after the battle of Vielos de los Navarros. He was afterward taken prisoner, and released on parole. Then he served in the Russian army in Circassia, and afterward joined Kossuth in the Hungarian Revolution, becoming commander of the Fortress Comorn. Going to America in Kossuth's interest, he joined, in 1856, William Walker in his expedition to Nicaragua, where he was given command of the artillery. He distinguished himself by his defense of Granada, and in the victory of Queresma. After Walker's surrender to Commodore Davis, United States navy, in 1857, Henningsen returned to the United States. At the outbreak of the Civil War he entered the Confederate army as colonel, but soon afterward was made brigadier-general. He was an able artilleryist. Henningsen published *Revelations of Russia* (1845); *The White Slave*, a novel; *Eastern Europe*; *Sixty Hours Hence*, a novel of Russian life; *Past and Future of Hungary*; *Personal Recollections of Nicaragua*. He died in Washington, District of Columbia, June 14, 1877, where he had settled after the Civil War.

**HENOTHEISM.** See THEISM, Vol. XXIII, pp. 235-237.

**HENRIETTA**, a town and the capital of Clay County, northeastern Texas, on the Fort Worth and Denver City and the Missouri, Kansas and Texas railroads. It is in an agricultural and stock-raising country, and some coal has been found near by. It has flour-mills, an ice and a cigar factory, and is supplied with electricity and city water. It has a Roman Catholic convent, a normal college and public and private schools. It was once destroyed by Indians, previous to the Civil War, and was re-established in 1874. Population 1890, 2,100; 1900, 1,614.

**HENROTIN (MRS. CHARLES) ELLEN MARTIN**, an American social reformer; born in Portland, Maine, in 1848, of an old New England family. She was educated partly in America and partly in England, France and Germany; was married, in 1869, to Charles Henrotin, a banker in Chicago. She became a leader in the principal women's clubs of Chicago; was made vice-president of the woman's branch of the World's Congress Auxiliary in Chicago, in 1893, in which she was an active worker, achieving considerable reputation thereby; in Philadelphia, in 1894, was elected president of the Federation of the Women's Clubs of the United States; was re-elected for two years in Louisville, Kentucky, in May, 1896. She contributed the articles on INDUSTRIAL CONDITION OF WOMEN, WOMEN'S CLUBS and WOMEN IN AMERICA to these Supplements.

**HENRY**, a village of Marshall County, north-

ern central Illinois, on the Illinois river, 120 miles S. of Chicago; has a paper-mill, a wagon factory, wind-mill factory, and grain elevators, and is the seat of Marshall College. Population 1900. 1,637.

HENRY, CAPE, in Princess Anne Co., Va., at the entrance of Chesapeake Bay. Has a lighthouse showing a fixed light 120 feet above the sea.

HENRY, FORT, in the northwestern part of Tennessee, on the Tennessee river. In the early part of the Civil War it was garrisoned with 2,700 men under the Confederate general, Tilghman. In Feb., 1862, General Grant advanced upon it with a land force of 17,000 men and a fleet of seven gunboats under Commodore Foote. The gunboats arrived first, and forced Tilghman to surrender, Feb. 6. Owing to floods which delayed the advance of the land force, most of the garrison escaped to Fort Donelson.

HENRY, CALEB SPRAGUE, an American clergyman and author; born in Rutland, Vt., Aug. 2, 1804. Graduated at Dartmouth in 1825; studied theology at Andover and New Haven, and was ordained minister of the Congregational Church in 1829; held pastorates in Greenfield, Mass., and in Hartford, Conn.; ordained priest in the Episcopal Church in 1836; professor at Bristol College, Pa., 1835-38; professor of philosophy in the University of New York, 1839-52; rector of St. Clements, New York, 1847-50. He was one of the founders of the *New York Review* and the *American Advocate of Peace*. He published *Cousin's Psychology* (1834), translated from the French; *Compendium of Christian Antiquities* (1837); *Moral and Philosophical Essays* (1839); *Guizot's History of Civilization*, with notes; *Ancient and Modern History* (1845); *Epitome of the History of Philosophy* (1845); *Dr. Oldham at Greystones, and His Talk There* (1860); *Social Welfare and Human Progress* (1860); and *Satan as a Moral Philosopher* (1877). Died March 9, 1884.

HENRY, GUY VERNOR, American army officer; born at Fort Smith, Indian Territory, March 9, 1839. He was the son of Major William Seaton Henry (1816-51), who served in the Florida war of 1841-42, and in the Mexican war, and wrote *Campaign Sketches of the War with Mexico* (1848). The son, Guy Vernor Henry, graduated at the Military Academy in 1861, and was assigned to the artillery. On May 14, 1861, he was made first lieutenant, and was on General McDowell's staff at the battle of Bull Run (July 21, 1861). He commanded a battalion in General David Hunter's unsuccessful expedition against Charleston, S. C. (May-June, 1862); and was brevetted captain for gallantry in an action near Pocotaligo, S. C. (Oct. 22, 1862). On Nov. 9, 1863, he was made colonel of the 40th Massachusetts volunteers. In 1864-65 he commanded a brigade in the army of the James, and for services before Petersburg he was made brevet brigadier-general of volunteers (June 30, 1864), and brevet lieutenant-colonel in the regular army (Sept. 30, 1864). On Dec. 1, 1865, he was made captain of the First Artillery. In 1874 he accompanied Custer in the expedition to the Black Hills, S. D., where he was severely frost-bitten. On June 17, 1876, he was wounded and lost an eye in the battle with Sitting Bull at Rosebud Creek, Mont. On June 26, 1881, he was pro-

moted to be major of the 9th cavalry, and stationed at Salt Lake City. In 1884 he was stationed at Fort Leavenworth, Kan., and in 1887 at Omaha, Neb. On Jan. 30, 1892, he was promoted lieutenant-colonel of the 7th cavalry, and on June 1, 1897, colonel of the 10th cavalry. During the war with Spain (April-August, 1898) he was made brigadier-general of volunteers, and was in command of the second brigade of General Wilson's division of the Puerto Rico expedition, and took part in the brief campaign in that island. On Sept. 28, 1898, he was made brigadier-general in the regular army; and from Dec., 1898, to May, 1899, was governor-general of Puerto Rico. He wrote *Military Records of Civilian Appointments in the United States Army* (2 vols., 1865-71); *Army Catechism for Non-Commissioned Officers and Soldiers* (1881); and *Manual of Target Practice* (1884). Died in New York, Oct. 27, 1899.

HENRY OF BATTENBERG. See BATTENBERG, HENRY MAURICE, OF, in these Supplements.

HENSCHEL, GEORG, a German singer and composer; born Feb. 18, 1850, at Breslau, Germany; studied music at Leipsic and Berlin, and began to sing in concerts; in 1881-84 was conductor of the Boston Symphony Orchestra, and in 1885 took up his residence in England. His voice was a baritone of great strength, richness, and compass.

HENSON, JOSIAH, an American clergyman; born at Port Tobacco, Md., in 1787. He was a negro, and was born and bred a slave. Mrs. Stowe took his life as the foundation for *Uncle Tom's Cabin*. His arms were crippled as the result of blows from a Maryland overseer. Although he paid \$500 toward purchasing his freedom, his master's son took him to New Orleans to be sold. The latter was attacked with yellow fever, and the slave accompanied him back to Kentucky and nursed him through his sickness. He finally escaped with his wife to Canada, carrying his two children through swamps and thick forests. "Uncle Si," as he was called, settled on Sydenham river, Ontario, near the present town of Dresden, and prospered as a farmer. He was also the pastor of a church. When 52 years old he learned to read and write. In 1858 he published an *Autobiography*. He went three times to England, lecturing and preaching in various cities, and was, in 1876, presented to Queen Victoria at Windsor Castle. Died in Dresden, Ont., in 1881.

HENTY, GEORGE ALFRED, an English writer, born at Trumpington, Eng., Dec. 8, 1832; educated at Westminster School and at Cambridge; went to the Crimea in the Purveyor's Department, and later served in Italy and England; engaged in mining in Wales and Italy, and later became correspondent for the London *Standard* in the Austro-Italian, Franco-German, and Turco-Servian wars; the Abyssinian and Ashanti expeditions; with Garibaldi in the Tryol; and in the Carlist insurrection in Spain. He wrote *With Clive in India*; *With Lee in Virginia*; *By England's Aid*; *In Freedom's Cause*; *Under Drake's Flag*; *By Pike and Dyke*, and a host of others, largely juvenile stories of adventure, based on history.

HENTZ, CAROLINE LEE, an American writer, daughter of General John Whiting; born at Lancaster, Mass., June 1, 1800. In 1824 she married

Nicholas M. Hentz, a French teacher, and in 1831 moved with him to Covington, Ky., where they conducted a young ladies' seminary. She wrote plays and novels of a sensational character, dealing mostly with society in the Southern states, including *De Lara*, a tragedy, which won a prize of \$500 offered by the directors of the Arch Street Theatre, Philadelphia; *Linda* (1850); *The Planter's Northern Bride* (1854); and *Ernest Linwood* (1856). Died Feb. 11, 1856.

HEPATICÆ. See LIVERWORTS, Vol. XIV, p. 718.

HEPATITIS. See PATHOLOGY, Vol. XVIII, 396.

HEPBURN, JAMES CURTIS, an American missionary; born in Milton, Pa., March 13, 1815; graduated at Princeton in 1833, and from the medical department of the University of Pennsylvania in 1836. In 1841-46 he was medical missionary in China; practiced in New York 1846-59; then went to Japan as missionary; worked there as physician and in the translation of the Bible and the compilation of a Japanese-English and English-Japanese dictionary. The latter was published in 1867. In 1892 he published a *Japanese Dictionary of the Bible*.

HEPPENHEIM, an old walled town and a health resort of Hesse, Germany, 16 miles S. of Darmstadt; noted for its excellent wine, and for the ruins of the castle of Starckenburg. Population 5,300.

HEPTAGON, a plane figure of seven sides and seven angles; when the sides and angles are equal, the figure is a *regular heptagon*. Geometers have hitherto failed to discover a method of inscribing the heptagon in or of circumscribing it about a circle, and the problem is believed by many modern mathematicians to be impossible of solution by geometry.

HEPTANOMIS, seven divisions of Egypt. See EGYPT, Vol. VII, p. 701.

HEPTARCHY, the seven kingdoms which were finally united to form early England. See ENGLAND, Vol. VIII, pp. 269-72.

HEPWORTH, GEORGE HUGHES, an American clergyman and writer; born in Boston, Mass., Feb. 4, 1833; graduated at the Theological School at Cambridge in 1855; held pastorates in Unitarian churches at Nantucket, 1855-57; and in Boston, 1858-70; in 1862-63 served as army chaplain in the Forty-seventh Massachusetts and on the staff of General Banks; in 1870-72 was pastor of the Church of the Messiah, New York; in 1872 he declared himself a Trinitarian, and organized the Church of the Disciples, of which he was a pastor until 1879; pastor of the Congregational Church at Newark, N. J., 1882-85; left the pulpit and went on the staff of the New York *Herald*. He wrote *The Whip, Hoe, and Sword* (1864); *The Criminal, The Crime, The Penalty* (1865); *Rocks and Shoals* (1870); *Starboard and Port* (1876).

HERACLEIDÆ, descendants of Hercules. See GREECE, Vol. XI, p. 92.

HERALDS' COLLEGE. See HERALDRY, Vol. XI, pp. 687-88.

HERBERT, HILARY A., an American statesman; born in Laurensville, S. C., March 12, 1834; educated at the Universities of Virginia and Alabama; admitted to the Alabama bar, and then served in the Confederate army until 1864. After the war he

resumed practice in Alabama, at Greenville and Montgomery. He was elected as a Democrat to consecutive Congresses from the Forty-fifth to the Fifty-second; in 1893 became Secretary of the Navy.

HERBERT, JOHN ROGERS, an English painter; born at Maldon, Essex, Jan. 23, 1810; studied art at the Royal Academy, London, and for a while was obliged to support himself by portrait-painting and illustrating; studied in Italy, and in 1839 exhibited his *Brides of Venice*; in 1840 became a Roman Catholic, and turned his attention to the painting of events in religious history. In 1846 he was elected to the Royal Academy, and was employed on mural decorations for the new Houses of Parliament. He painted *The Introduction of Christianity into Britain* (1842); *Christ and the Woman of Samaria* (1843); *St. John Reproving Herod* (1848); *Moses Descending from the Mount with the Tables of the Law* (in the Houses of Parliament); *Adoration of the Magi* (1874); *Ruth with the Reapers* (1883). Died March 17, 1890.

HERBERT, SYDNEY, LORD HERBERT OF LEA, an English statesman; born at Richmond, Sept. 16, 1810. Educated at Harrow and Oriel College, Oxford; from 1832 to 1861 was M. P. for South Wilts; secretary to the admiralty, 1841-45; secretary for war, 1845-46, 1852-55, and in 1859. He was an able and popular Conservative leader, his army administration being signalized by great improvements in the sanitary condition and education of the army, the amalgamation of the Indian with the royal army, and the organization of the volunteer force. In 1861 he was created Baron Herbert of Lea. He was heir-presumptive to the earldom of Pembroke, and his son became thirteenth earl in 1862. Died at Wilton, Aug. 2, 1861.

HERCULANO, ALEXANDRE (1810-1877), a Portuguese writer. See PORTUGAL, Vol. XIX, p. 558.

HERCULES, PILLARS OF, the name given by the ancients to Calpe (now Gibraltar) and Abyla (now Ceuta), two rocky promontories forming the entrance to the Mediterranean Sea. According to the fable, they were originally one rock, but were torn asunder by Hercules.

HERCULES BEETLE (*Dynastes hercules*), a gigantic lamellicorn beetle from tropical America. The male bears on the thorax an enormous horn, which is met by a shorter upturned horn from the head. The female is without horns, and smaller. Another species, *D. tityus*, about two inches in length, occurs in the United States. The genus *Megasoma* is regarded by entomologists as nearly allied to *Dynastes*. See COLEOPTERA, Vol. VI, p. 131.

HERCYNIAN MOUNTAIN SYSTEM. See AUSTRIA, Vol. III, p. 116.

HÉRÉDIA, province and town. See COSTA RICA, Vol. VI, p. 450.

HEREDIA, JOSÉ MARIA DE, a French poet; born near Santiago, Cuba, Nov. 22, 1842; studied in the École des Chartes, Paris, and began to write for the *Temps*, *Revue des Deux Mondes*, and other Parisian periodicals. His reputation rests on a volume of sonnets much admired by the literary class. He was elected to the Academy, Feb. 22, 1894.

HEREDITAMENTS are things which are legally

capable of being inherited. They are either corporeal or incorporeal. Corporeal hereditaments are things of a substantial, permanent nature which have a tangible existence, as land and other similar property. Incorporeal hereditaments are those classes of inheritable property which are not tangible or visible, but which are rights which grow out of something corporeal, as commons, ways, franchises, rents and other similar classes of property.

HEREDITY, PLANT. See REPRODUCTION, in these Supplements.

HEREDITY, THE NEW. Perhaps in no branch of science has greater progress been made both in original research and in the development of theories based thereon, than in the laws governing heredity. The advances in the former and the changes in the latter have been so enormous that the whole are fittingly embodied in the caption above given. A complete revolution has taken place in the methods of investigation, in the results attained, and in the theories derived therefrom. To such an extent is this true that the new heredity is likely to become the chief corner-stone of evolution itself.

Interest now centers not in what are or what are supposed to be the final results of heredity as seen in the individual, but in the nascent influences determining those results traceable from the earliest period of regeneration or recreation in the new being itself.

The assurance of the existence and the certainty of the location of a particular substance credited with hereditary continuity, is the great fact of the history of the histological research in this direction. The substance seems to be fully recognized in both egg and sperm-nuclei.

The central ideas, to which all others are subordinate, are embodied in what is comprehensively termed Weismannism—or the system laboriously elaborated by Professor August Weismann of Freiburg, in Brisgau (Baden).

The preliminary consideration of the subject thus involves the study of the elementary products of generation, viz., the ovum and spermatozoon. For this the reader is referred to the article REPRODUCTION, Vol. XX, p. 407; and EMBRYOLOGY, Vol. VIII, p. 163, and in these Supplements.

The special details of these articles, to be carefully studied, refer to the homologies of oögenesis and spermatogenesis; the significance of the extrusion of the polar bodies; the chromosomes and the centrosomes; karyokinesis (see PROTOZOA, Vol. XIX, p. 833); and parthenogenesis (see Vol. XII, p. 574; Vol. XIII, p. 146; Vol. XX, p. 427). Especially to be noted are the processes of *Reducing Division*, by means of which the egg and sperm-cell receive half the number of chromosomes, originally present in the egg and mother-sperm cell respectively; of *Fertilization*, or the union of the nuclei of the egg and sperm cells to form an oöspERM, true germ, or embryo, in which the normal number of chromosomes is restored; and which gives significance to what is called amphimixis (see REPRODUCTION, Vol. XX, p. 417, 418); and of *Cell Lineage*, which traces the germ-cells to the germ-layers of the embryo, i.e., the mesoderm which has no converse with the ex-

ternal layers; where the germ-cells are early differentiated, where their integrity and continuity are secured, and where their independence of other cells seems demonstrable. (See EMBRYOLOGY, Vol. VIII, pp. 163-167.)

The central fact of the new heredity is that each segmentation nucleus contains one half of the number of original male chromatin loops *plus* one half of the female. As all subsequent cell-division proceeds as described, by a continual interstitial growth, this intermixed male and female chromatin must be distributed in the mature individual during life in gradually diminishing force, until its longevity is interfered with by natural death.

Besides, as this process of regeneration which occurs as a result of fertilization is ever continuously the same at each generational period, it can be very readily conceived that there must be a continuity of some part of the germ-plasm which can give rise not only to the production of the cells of the body and thus of the individual, but also to the production of cells referable to the preservation of the potential germ-plasm itself, and thus of the race.

In the *fundamental plasms*, independently of the nutritive or secondary plasm (deutoplasm), as seen in the well-stored egg, we have to deal with two kinds of protoplasm alone in the simplest form of sexual cells: (1) the cytoplasm or cell-plasm outside of (2) the nucleo-plasm of the nucleus.

Here we have at once the simple distinction which Weismann maintains exists throughout multicellular organisms; that is, the individual or *body cells* (somatoplasm), and the reproductive, ancestral or *germ-plasm*. But in the complicated process of the rapid transformation of these cells into others descended therefrom, we have to imagine the existence of a reproductive plasm of a disposition to differentiate in certain well-defined directions. Hence Weismann, in so conceiving the germ-plasm, finds it convenient to give to germ-plasm acting in its several conceived rôles, names indicative thereof. To aid the student, Dr. G. J. Romanes (*An Examination of Weismannism*, 1893, p. 32), has tabulated these plasms in a useful manner. This tabulation we use here in an altered form, to enable us to represent as graphically as possible the whole scheme and purpose of cell-plasms in their relations to one another and the results produced therefrom. In this tabulation occurs the new and very useful name of "idio-plasm" (from the Greek *idios*, meaning "one's own self"). It may be regarded as the active force of germinal or intracellular life.

{ Cytoplasm = all the contents of the cell other than nucleo-plasm.

{ Nucleo-plasm = the whole contents of any cell nucleus.

|| Idio-plasm.

A = that portion of a nucleus which "controls" a single cell.

B = that portion of nucleo-plasm which is destined to construct future cells.

|| Germ-plasm = undifferentiated idio-plasm B.

Somato-plasm = idio-plasm A + cytoplasm.

Broadly speaking, the cytoplasm and nucleo-plasm together represent the starting-point of the individual; the idio-plasm represents the substance that

transforms the first-named into the perfected somatoplasm or individual, while preserving by its isolation the germ-plasm, the integrity of which is kept intact for handing on the phylogeny to future generations. It is meanwhile, in a latent condition, but ever ready to differentiate whenever the fertilizing impulse again demands it.

The ideal mechanism of heredity, as conceived by Weismann, consists of the following parts:

(4.) *Idants*, the definite arrangements of the hereditary substance in the nucleus, already known to us as the loops or chromosomes and composed of granules or microsomes.

(3.) *Ids* (formerly designated the "ancestral germ-plasms"), consisting probably of the microsomes. They are clearly defined and localized vital units, possessing a fixed architecture, "indissolubly united in phylogeny, and, therefore, transmitted (each) as one complex whole" (Romanes). The ids are composed of the

(2.) *Determinants*, the primary constituents of a cell or of a group of cells, possessing special qualities "capable of directing the ontogeny of such; and such a group of cells as is independently variable from the germ onwards" (Romanes). The determinants consist of groups of

(1.) *Biophors*, the bearers of vitality and of cell qualities. They are of different kinds and are the ultimate (or initial) units of the germ-plasm, and themselves consist of a number of simple molecules (properly) chemically understood, and therefore capable of unlimited rearrangement.

Let us obtain a conception, if we can, of the minuteness of these biophors. The largest idants as yet observed are those of the thread-worm of the horse (*Ascaris megalocephala*). Each of the idants of this animal is composed of six more or less distinct granular portions (microsomes). Supposing an id to be as large as one of the larger of these spherules or granules, it would measure about 0.0008 of a millimeter in diameter, and would contain two millions biophors of such a size that seven hundred and three millions of them could be contained in the cube of a blood corpuscle. Each of these biophors, determinants and ids, in regard to each other and their related constituents, has a certain autonomy of its own, and is, we may conceive, endowed with the regal capacity of variation and differentiation in initiatory and determinative results.

The possibility of variation thus depends upon the changes and interchanges of relationship in the component parts named, as well as upon the varied opportunities of growth that occur during the process of amphigony. To illustrate the infinite possibilities of the idants and their constituent units, the following illustration may be used: Tacquet, the mathematician, has calculated that one thousand million writers in one thousand million years could not write out all the combinations of the 26 letters of the alphabet if each of them were daily to write out forty pages of these combinations, each page containing different orders of the letters. It would indeed require an "immortality" to accomplish such a task, but the biophors are being continually augmented by growth to take the place of such as may

be worked out of the combination. Thus the biophors are constantly rearranged and reconstituted from their self-generating potentiality. The biophors are indeed not only the carriers of heredity, but the creators of careers.

*The immortality of the germ-plasm* is also an idea of Weismann, which we have endeavored to develop in the remarks preceding; and now no one is surprised at what is only metaphorically synonymous with the more sedate phrase, "continuity of the germ-plasm." Even this was considered a heresy in its apparent meaning; but when analyzed, we obtain a substantial thought which represents the descent of progeny from ancestors, sometimes referred to as the "lineage." The idea had been already anticipated in the declaration: "We are the same our fathers have been"; while another expressed the idea when he said:

"My flame expires, but let true hands pass on  
An unextinguished flame from sire to son."

Thus we must imagine an ever-present surplus of creative substance, guarded, as it were, within sacred precincts, experiencing a separate existence amidst surrounding microcosms. Weismann believes that after segmentation a minute portion of the germ-plasm is preserved in its integrity, and "remains unaltered in one of the daughter-cells mingled with its nuclear idio-plasm, but in an inactive state; and that it traverses in this manner a longer or shorter series of cells, till, reaching those cells on which it stamps the character of germinal cells, it at last (again) assumes the active state."

This lineal as well as linear course traversed by the germ-plasm, leads directly to and from the germ-cells, originating in the mesoderm—"a layer which," according to Spencer, "as the mode of formation implies, never has any converse with the surrounding medium and its contents, or with the nutritive bodies taken into it"—which is of vital importance for any theory that might refer to germ-plasm.

If we can thus conceive of the germ-plasm overflowing, as it were, in certain directions for the purpose of carrying from a preceding generation to that following certain individual characters, while retaining in all its integrity the mainspring of racial or specific characters, we must at once accept the hypothesis of the absolute independence of the germ-plasm from the somato-plasm. This hypothesis involves the corollary that the characters that appear to arise newly in the individual, the existence of which commences at the period of segmentation, belong only to the individual, die with it, and cannot be transmitted.

Upon this rock, evolutionists have split. It is this difference that has aroused such an intensity of interest to the extent of dividing an apparent impregnable union of evolutionists into two antagonizing camps holding two opposing views, embodied in the names Neo-Darwinism and Neo-Lamarckism (q.v., in these Supplements).

Neo-Lamarckians deny Weismannism because it upsets their work, removes the foundations from the apparently sure structure they thought to have erected, and leaves them, in fact, no place among evolutionists. To this they refuse to submit. Neo-

Darwinians, on the other hand, hail Weismannism as enabling them to explore the very sources and fountain-head of evolution.

The difference between the two theories, arising from a difference in view as to the processes by which the same end, the origin and heredity of variations, is accomplished, must now be noted. Lamarckism evidently involves the process known as pangenesis (see *BIOLOGY*, Vol. III, p. 690), on which it is unnecessary here to dilate, it being well understood. In contradistinction to this, Neo-Darwinians maintain the distinctively Weismannian plasmogenesis (or origin of variations from the germ-plasm) by its own inherent activity, to use the words of Erasmus Darwin. (See Vol. VI, p. 830.)

If we could eliminate the conception of the pangenetic process, we might describe the material basis of heredity (as conceived of by Weismann) as the stirps of Galton constituted of Spencer's "physiological units, in all of which dwells the intrinsic aptitude to aggregate into the form of a certain species."

Natural selection has at the very beginning a free hand and the first word. The battle for the survival of the fittest nascent characters is at once inaugurated, being continued until it is eventually fought out between individual and individual, species and species. The potential disposition of the nascent constituents of the stirps is toward the selection or choice and initial encouragement of the determinants of these characters that will or can take the fullest advantages of the novel environmental conditions always presented to them. Thus natural selection at once adopts and adapts what, out of its infinitude of choice, will give individualism a continuous advantage in the struggle for the preservation of self and race. It is, then, according to the new heredity, the variation that fits the environment, not the environment that fits the variation.

Selection, therefore, has its most advantageous opportunity whenever the influence of fertilization sets the machinery of heredity in motion. The selection is germinal. The process has a constantly renewed opportunity of intensifying its effects by amphimixis (the mingling of the hereditary substances of two like individuals in an act of sexual selection); and its cumulative effects are always interrupted by the process of panmixia (the condition of free-intercrossing, or what Romanes described as the "cessation of selection").

This conception of "germinal selection" has been indeed the latest of Weismann's contributions to his theory. It was the subject of an address recently delivered by him and translated and published, January, 1896, in *The Monist* (vol. vi, p. 292), in which he says: "By a selection of the kind referred to, the germ is progressively modified in a manner corresponding with the production of a definitely directed progressive variation of the part." Going back to the self-originating point in this process, the selection may be described in the words of a Lamarckian, Prof. H. F. Osborn, as "the disposition to adaptive atrophy or hypertrophy at certain points"; but, according to the followers of Weismann, strictly within the germinal elements.

A few illustrations may be cited to illustrate, in part, the two opposing processes. Take the case of mimicry in insects. The Lamarckians explain this by saying that the insect, constantly striving to appear like a certain leaf, for protective purposes, by some means develops outwardly a distinct resemblance to the leaf it desires to imitate. This result it contributes in pangenes, to the material basis of heredity, and thus transmits its individual accomplishment to its progeny. That progeny follows the excellent example of the thoughtful parent, the effort is repeated and transmitted, and so on until the consummation has been reached in the fortunate descendants. But, in the mean time, it might be asked by the thinking originators of this mimicry: What has posterity done for us and our present condition that we should waste our efforts to accomplish a future result of no present benefit to ourselves, especially when it is the present advantage that determines in the struggle for existence? The Darwinian would explain the case thus: That as certain insects, by germinal variation and selection, exhibit a disposition to resemble certain leaves, not fortuitously but fortunately, those so characterized have at the very start a better chance of surviving, and therefore of reproduction. Segregation and amphimixis increase the tendency to the so-called mimicry. The often misrepresented case of the giraffe is the same. Lamarckians say that the animal, suddenly thoughtful of the browsing benefit of his descendants, while he himself must perhaps starve, comes to the conclusion that he must stretch his neck, throw the stretching effects off in gemules, and pangenetically transmit the result to the next generation of giraffes, when at length, if starvation has not obliterated the persevering intention, the long neck is attained and the nutritive salvation of the race is accomplished. But while this has been going on, the whole locomotor apparatus is thrown so thoroughly out of gear that the unfortunate animal would be an easy prey to its devouring enemies. (Spencer, *Factors of Organic Evolution*, p. 15.)

The explanation by Darwinians of the "stretching" is simply that certain giraffes come into existence with longer necks than others and can secure food at greater heights, and have thus an advantage over their less well-favored companions. Natural variation, as in the former case, determines at its earliest stages the extension of the neck, which is of advantage to the race. Natural selection accomplished what germinal selection began.

Goethe saw the difficulty when he "pointedly remarked" that the future question for naturalists will be, for instance, "why cattle get their horns, and not for what they are used." Lamarckists explain this case: "It is well known that in many cases shocks, repeated blows or frictions cause the repairs to exceed the waste, and excrescences of bone are the results, as in the hands and feet. The bony excrescences on the heads of horned animals have been explained as having arisen in this way, under the intensifying effects of inheritance and selection." (Dr. Henry B. Orr, *A Theory of Development and Heredity*, p. 163; see also Spencer, *Factors*, p. 7). But, replies the Darwinian, is it reasonable to sup-

pose that a pugnacious bull became so from the deliberate determination of ancestral peaceful bulls to injure themselves against each other while heroically enduring the "callosities consequent upon the habit of butting"? This case of indelible contusion reminds one of the prize-ring. If the horns were derived in the way supposed, why could we not have a race of pugilists with heads exhibiting protuberant points of defense, derived from the inability of their ancestors to avert the blows so well directed by the victors? But then, the survivor in the original contest, coming off with few marks of the battle, could not contribute to the benefit of his descendants, who would find themselves quite anomalously placed and at an absolute discount—the process in this case working in an entirely opposite manner.

The evolution of the trotting-horse has been similarly explained by Lamarckians: "The shock of the feet striking the ground furnishes the motive for the lengthening of the bones." (Orr, *sup. cit.*, p. 164). Such a process has been strongly insisted upon by the distinguished American palæontologist, Dr. Edward Drinker Cope, in his recent works. But it might be permitted to offer another explanation: that it is more logical to suppose that the natural tendency to produce longer legs, cannon-bones, etc., marked those so originally characterized as more adapted to the new environment found by or forced upon the progenitors of the horse, and was developed *de novo*; rather than that the several-toed animal, being placed upon an uncongenial terrain, should have to "think out" laboriously by continual severe poundings the salvation of his descendants, while he was reaping direct disadvantage in the mean time. The Darwinians think it more reasonable to suppose that the animals capable of taking instant advantage of the new environment would have the best chance of perpetuating a race with long shank-bones. Besides, a practical horseman would on this point speedily inform the investigator that it is of these very poundings that the horseman stands in most dread; for it is these shocks and strains and impacts that cause the "break-down" of colts—so carefully avoided by trainers. If the Lamarckian theory were true, we would soon have a race of horses incapable of "going" in any form.

The general understanding we have obtained of the germ-plasm tends to explain those phenomena apparent in individual growth which may be referred to the reproductive remains of the idio-plasm in the somatic tissue, such as repair, budding, graft hybridization, dichotomy, etc. But, furthermore, such a rational conception of the germ-plasm should be able to offer a substantial solution of such phenomena, arising as a result of fertilization, as twins, hybridity, and perhaps the relative prepotence of parents, as well as the overpowering and suppression of influence by one or other parent.

Again, though the essential hereditary matter is of different sexual origin, Weismann regards it, in the segmentation-nucleus, as sexless, be-

cause there is no apparent sex in the embryo visible during its early development. But sex is, evidently, determined or becomes apparent by the action of mysterious agencies on what we can regard only as the hermaphroditic elements derived from the mingling of the paternal and maternal chromosomes.

The facts as to the likeness or unlikeness of progeny to one or other parent and to each other, particularly in regard to full brothers and sisters, seems to be referable to the re-combinations occurring within the idants. These further resolve themselves into the more general phases of atavism and variation, of accumulation and elimination, and of progress and retrogression. Thus we approach the domain of the possibilities of evolutionary heredity as it affects in its widest scope the human race itself, the consideration of which is beyond the limits of this article.

But there are some forms of transmission which have been brought forward as arguments against the acceptance of the new heredity. These are: (1) *Initial heredity*, or results supposedly due to the condition of the parents at the time of coition; (2) *Sympathetic heredity*, or results supposedly due to the effects of imagination upon the dam at the time of impregnation and early conception; (3) *Artificial heredity*, or results supposedly due to the acquirement of artificial characters by the parents, such as mutilations, etc.

Lastly, we have the often-advanced argument of *Telegony*, or the results supposedly due to the influence of the primary impregnation on subsequent progeny by other sires. Admitting this, what is to be done with the form of heredity which we may call *Metagony*, described as referring to the results supposedly due to the later, or after-developed, influence of one sire's impregnations on a female of a different variety (whose first and some immediately subsequent progeny resemble herself entirely and not the sire), as shown, for example, in the fourth, fifth and sixth, etc., progeny, which resemble the sire and not the dam?

But whatever the results of the forms of heredity mentioned in the two preceding paragraphs may be, it must be pointed out that the struggling hereditary force remaining to carry the race, as so represented, onward, is directed, not to the preservation of such monstrous characters, but to their elimination.

Some have gone so far as to assert that, according to Lamarckism, "anything is transmissible"; while Weismannism claims that "nothing goes into the offspring but what comes out of the parents," and, in the mature individual, nothing can be got out of it that is not in it. Here comes forward the argument of training, schooling, etc., the results of which have usually been claimed as belonging to the class of characters called "acquired." Training, etc., in any direction, mental or physical, is very evidently worthless unless there is "that within" the individual which is capable of being developed, of "coming out." This kind of test is always helpful in discovering what



abilities are inherent, and in what direction they can be best utilized. The results of training may thus be regarded, from Weismann's standpoint, as the measure of the adaptability of the determining units of the germ-plasm or stirps. Thus, in the same view, nurture favors nascence.

Weismannism teaches that variation in its self-origination, takes place and is determined at the very threshold of the regeneration of the nascent material of heredity.

Lamarckism believes in a sort of precipitation of the accretions or products of vicissitudinous individualism, involving the accumulation of a burden of monstrosities, against the transmission of which nature would revolt. Lamarckism has to assume full-fledged perfect pangenetic parents: for how could the recreating gemmules be produced without the finished individual? Such a theory of original creation seems incompatible with that of evolution itself, which Lamarckism claims to uphold. Weismannism inspires a different conception and confidence in the destiny of races. It strives to furnish an opportunity of reaching a future state of perfection by its potential ability of holding fast to that which is good, and continually leaving behind that which must fail. Thus it designs to attract by its promise of approximating to that goal of evolutionary aim—a point at which it might be found true that "The higher the life the less the strife"; and stepping in the direction of "one far-off, divine event to which the whole creation moves."

Historically considered, it should be pointed out that most of the theories of the new heredity have occurred to former thinkers. One hundred years ago, as indicated, Erasmus Darwin had the idea of germinal activity in his mind; and, contemporaneously with him, Dr. James Anderson (q.v., Vol. II, p. 14) in one of his works had also expressed views opposing the inheritance of acquired characters. Later, Galton had shown the significance of stirps (germ-plasm) and "double parentage," and Romanes showed the results of the "cessation of selection" (panmixia), while the idea of continuity seems to have been a general conception. What has been gained to-day seems to be the demonstration of a physical basis upon which such theories can be more fully and securely elaborated.

In dealing with this subject here, space has admitted only of its treatment in regard to the higher animals. The object has not been to plead specially for the new heredity, but to attempt to present it as it appears to be conceived of by its sponsors, as compared with the old theory. Its presentation in this manner has been deemed only its due. But the older doctrine has always a zealot following.

The truly splendid labors of Dr. Cope, in the palæontological field, and the arguments and illustrations of processes he has deduced therefrom, will long be regarded as their ægis by the American school of Lamarckists.

*Bibliography.* The reader is referred, for further study of this subject, to the following works, etc.: Francis Gal-

ton, *On Blood-Relationship*, paper read before the Royal Society, London (1872); *A Theory of Heredity*, in *Journal of the Anthropological Society*, London (1875); the same, reprinted in the *Contemporary Review*, December, 1875; *Hereditary Genius* (1869); *Natural Inheritance* (1889); *Experiments in Pangenesis* (1871). August Weismann, *Studies in the Theory of Descent* (1882); *Essays on Heredity* (1889-91); *The Germ-Plasm* (1893); *Germinal Selection*, reprinted from *The Monist*, with a preface, appendix and index (Chicago, 1896). Herbert Spencer, *The Factors of Organic Evolution* (1886). G. T. H. Eimer, *Organic Evolution as the Result of the Inheritance of Acquired Characters, etc.* (London, 1890). W. K. Brooks, *The Law of Heredity* (Baltimore, 1883). H. F. Osborn, *Are Acquired Characters Inherited?* (New York, 1875). W. Platt Ball, *The Effects of Use and Disuse* (1890). Lester F. Ward, *Neo-Darwinism and Neo-Lamarckism* (Washington, District of Columbia, 1891). H. B. Orr, *A Theory of Development and Heredity* (New York, 1893). G. J. Romanes, *Darwin and After Darwin* (2 vols., Chicago, 1892, 1896); *An Examination of Weismann* (Chicago, 1893). E. D. Cope, *Origin of the Fittest* (1887); *The Primary Factors of Evolution* (Chicago, 1896). Also, *Nature*, *Contemporary Review*, *American Naturalist*, *Popular Science Monthly*, etc., for these years.

R. C. AULD.

HEREDITY, THEORY OF. See EMBRYOLOGY, in these Supplements.

HERGENRÖTHER, JOSEPH, a German theologian; born at Würzburg, Bavaria, Sept. 15, 1822; studied theology at Würzburg, at Rome, and at Munich; in 1852 was made professor of canon law and church history at Würzburg. He was a vigorous upholder of the doctrine of papal infallibility, which he defended in his *Antijanus*. Among his other works are: *Catholic Church and Christian State* (1876); *Church History* (1884); and *Leonis X Regesta*, left unfinished at the time of his death, which occurred Oct. 7, 1890.

HERING, CONSTANTINE, a German physician; born at Oschatz, Saxony, Jan. 1, 1800. He studied medicine at Leipsic and Würzburg; was converted to homœopathy while preparing a refutation of its theories, and after personal acquaintance with Hahnemann became his admiring friend. The king of Saxony sent him to Surinam to study the flora and fauna of that country. In 1833 he arrived in Philadelphia, where he founded the first homœopathic school in the United States. From 1845 to 1869 he filled the chairs of homœopathic *materia medica* and medicine in this school. He edited the *Homœopathic Quarterly*, the *Homœopathic News*, and the *American Journal of Homœopathic Materia Medica*. He published in English and German on his favorite doctrine, among them the *Rise and Progress of Homœopathy*; *Effects of Snake-Poison*; *Condensed Materia Medica*; *Hering's Domestic Physician*; and *American Drug Proving*. He died in Philadelphia, July 23, 1880.

HERING, EWALD, a German physician; born in Saxony, Aug. 5, 1834; educated at Leipsic; tutor in medicine, Leipsic, 1862-65; professor in Vienna, 1865-70; in 1890 became professor of physiology at Prague. He was an investigator in the realm of psycho-physics, and is the discoverer of the accepted theory of color-vision. (See *PHYSIOLOGY*, Vol. XIX, p. 22.) Among his works are *Contributions to Physiology* (1861-64); *The Relationship of Body and Soul* (1875).

HERIOT, the right by which a feudal lord was

entitled to seize the tenant's beast or other chattel in the event of the tenant's death. See *COPYHOLD*, Vol. VI, p. 356.

**HERKIMER**, a village and the capital of Herkimer County, eastern central New York, on the Mohawk River and the West Canada Creek, with canal and railroad facilities. It is a thriving village; has good schools and street-railways. It is noted for its cheese and butter; it manufactures also flour, paper, knit-goods, air-guns and rifles, office desks, furniture and mattresses. Population 1890, 3,456; 1900, 5,555.

**HERKIMER, NICHOLAS**, an American soldier, born in Herkimer County, New York, about 1720. In 1758 he became lieutenant of militia, and commanded Fort Herkimer, on the Mohawk, during the attack of the French and Indians in that year. In 1775 he became colonel and chairman of the committee of safety of Tryon County, New York. A year later he was made brigadier-general in the New York militia, and fought during the Revolution until Aug. 5, 1777, when he was mortally wounded while leading an expedition to the relief of Fort Stanwix (now Rome, New York). He died at his home in Danube, New York, Aug. 17, 1777. Congress and New York united in erecting a monument to his memory in 1884.

**HERKOMER, HUBERT**, an English artist, born in Waal, Bavaria, May 26, 1849. He was taken to the United States by his father, Lorenzo Herkomer, a wood carver, in 1851, but in 1857 returned to Europe and studied at the Art School, Southampton, England, and under Frederick Walker at the South Kensington Art Schools in 1866. His pictures were first exhibited at the Dudley gallery in 1869, and his success was immediate. Is a member



HUBERT HERKOMER.

of the British Institute of Water Color Painters, Royal Academy and Berlin Academy. He personally directs the Art School at Bushey, near London of which he is the founder, and is a popular instructor. He was created an officer of the Legion of Honor in 1889, on account of services in connection with the Paris Exposition. Among his most famous works are *The Last Muster: At Death's Door: Missing: Natural Enemies: and Windswept*.

**HERMANDAD, SANTA**, or **HOLY BROTHERHOOD**. See *SPAIN*, Vol. XXII, p. 326.

**HERMANN**, a town and the capital of Gasconade County, central eastern Missouri, 81 miles W. of St. Louis, on the Missouri River and the Missouri Pacific railroad. It is a noted wine-producing town, and its inhabitants are mostly Germans. Its other more important products are beer, cigars, flour, carpenters' tools and castings. Population 1890, 1,410; 1900, 1,575.

**HERMAPHRODITISM**. See *MONSTER*, Vol. XVI, p. 764.

**HERMAPHRODITUS**, son of Hermes and Aphrodite. He inherited the beauty of both his parents, and was brought up by the nymphs of Mount Ida. At the age of 15 he removed to Caræ, and, being near the fountain of Salmacis, in the neighborhood of Halicarnassus, the nymph of the fountain fell in love with him. After trying in vain to win his affections she embraced him one day as he bathed in the fountain, praying, at the same time, that they might be united forever. Her prayer was answered and their bodies united, retaining the characteristics of both sexes. There are several statues of him, and on a large number of monuments he is grouped along with the Bacchic train.

**HERMANN OR ARMINIUS**. See *GERMANY*, Vol. X, p. 478.

**HERMAS**. See *APOSTOLIC FATHERS*, Vol. II, p. 197.

**HERMESIANISM**. See *HERMES, GEORG*, Vol. XI, p. 750.

**HERMIAS**, a slave in the household of Eubulus, tyrant of Atarneus and Assus, in Mysia, Asia Minor; being made free, he succeeded his master, Eubulus, 347 B.C.; was noted as the friend of Aristotle, who spent several years at his court. He was seized by Mentor, the Greek general of the Persian king, and sent captive to the Persian court, where he was crucified. Aristotle married his adopted daughter, Pythias, celebrated his praises in an ode to Virtue, and erected a monument to him at Delphi.

**HERMIONE**, a daughter of Menelaus and Helen; was very beautiful, and had been promised to Orestes before the Trojan War, but was married to Neoptolemus after Menelaus returned home. Orestes claimed her, and finally caused Neoptolemus to be slain at Delphi. He then married her. This story is varied at times so as to make Orestes the first husband of Hermione, from whom he was separated; and in the interval Neoptolemus seized her, and Orestes, returning, caused the Delphians to kill Neoptolemus.

**HERMIT-CRAB**. See *CRUSTACEA*, Vol. VI, p. 642.

**HERMITE, CHARLES**, a French mathematician, born at Dieuze, Lorraine, Dec. 25, 1822; studied first at Nancy and then at Paris; became professor of higher algebra at Sorbonne and honorary professor at the École Polytechnique. His articles on mathematics have appeared in scientific and mathematical journals in France and other countries. Among other honors conferred upon him were foreign member of the Royal Society, and of the Mathematical Society of London; of the Royal Society of Edinburgh; of the Academies in Berlin, Paris and Vienna; and commander of the Legion of Honor. He edited, in conjunction with Serret, *The Elementary Treatise of Lacroix on the Differential and Integral Calculus* (1867).

**HERMITIC BOOKS**. See *HERMES TRISMEGISTUS*, Vol. XI, p. 750.

HERMITS. See MONACHISM, Vol. XVI, pp. 699, 700.

HERMODACTYL ("Hermes's finger"), a bulbous root, formerly brought from Turkey and much esteemed as a cathartic, but entirely discarded in modern times. It is probably obtained from *Colchicum variegatum*.

HERMONTIS, now ARMENT, a town of Egypt. See EGYPT, Vol. VII, p. 782.

HERMOPOLIS or SYRA, the capital of Syra, an island of the Cyclades in the Ægean. It is on the eastern shore of the island, built about its harbor on a conical hill. It has since classical times been of great commercial importance. It is at present the residence of many European consuls, and is a station of the steamers going to and from Constantinople. It manufactures flour, ropes, glass, pottery, iron-wares, castings, handkerchiefs, sashes and yarn, and has tanneries, ship-yards, a gymnasium and a normal school. Population, 1896, 17,894.

HERMOPOLIS MAGNA, an ancient Egyptian city. See EGYPT, Vol. VII, p. 775.

HERNDON, WILLIAM LEWIS, an American naval officer; born at Fredericksburg, Virginia, Oct. 25, 1813. He served in the American navy and in the Mexican War. In 1851 he was sent to explore the Amazon River. He crossed the Andes from Lima to the headwaters of the Amazon, and then sailed down the river in a canoe. The United States government published two volumes of Herndon's *Exploration of the Valley of the Amazon*. In 1857 he was captain of the steamer *Central America*, which, with 580 persons on board, sailing from Havana for New York, sank in the Gulf stream, September 12th. The women and children were saved, but Herndon with 426 men sank with the vessel. His daughter was the wife of President Arthur.

HERODES. See ATTICUS HERODES, Vol. III, p. 61.

HERODIONES, order of Herons. See ORNITHOLOGY, Vol. XVIII, p. 47.

HEROÓPOLIS. See RAMESES, Vol. XX, p. 265.

HEROPHILUS, ancient Greek physician. See ANATOMY, Vol. I, p. 802; also, MEDICINE, Vol. XV, p. 801.

HERO'S APPARATUS. See STEAM ENGINE, Vol. XXII, p. 473.

HEROSTRATUS. See EPHESUS, Vol. VIII, p. 466.

HERPES. See SKIN DISEASES, Vol. XXII, p. 123.

HERPETOLOGY. See REPTILES, Vol. XX, pp. 432, 433.

HERRON, FRANCIS JAY, an American soldier; born in Pittsburg, Pennsylvania, Feb. 17, 1837; graduated at Western University of Pennsylvania, 1853; and in 1861 entered the army as captain of volunteers from Iowa. He served in the operations west of the Mississippi; rose to the rank of major-general of volunteers, and in 1865 received the surrender of the trans-Mississippi army of the Confederates. He was Indian commissioner in 1865, but resigned during the same

year, at the same time resigning from the army. He was United States marshal in Louisiana, 1867-69; secretary of state of Louisiana, 1872-73; and afterward took up his residence in New York City.

HERRING-GULL (*Larus argentatus*), a bird of the gull family, common on the west coasts of Europe. There is an American variety.

HERRMANN, ALEXANDER, an American magician, known as "Herrmann the Great," of Hungarian and Jewish ancestry; born in Paris, Feb. 10, 1844. He passed for the brother of the prestidigitator, Carl Herrmann, from whom he learned his art as a boy, but there is reason to think that Alexander's name was Nieman, and that he was of Hungarian birth. His first wife was the Hungarian prima donna Rosa Csillag (1835-92), from whom he was speedily divorced. In 1859 he gave a court exhibition at Madrid; two years later he and his brother came to the United States and appeared at the Academy of Music, New York, and gave exhibitions in almost every town in the Union. He was naturalized at the earliest opportunity; made highly lucrative tours in America, Europe, Siberia, India, and Australasia; became renowned for his sleight of hand; was usually assisted by his second wife, an actress whom he married in 1881. Died in his car near Salamanca, N. Y., Dec. 17, 1896.

HERSCHELL, FARRER, LORD, an English statesman; born Nov. 2, 1837. After being educated at the Universities of London and Bonn he was called to the bar; became a Queen's counsel in 1872, and recorder of Carlisle in 1873. In 1880 he was solicitor-general in Gladstone's ministry, and in 1886 became Lord Chancellor and Baron Herschell. On the appointment of a royal commission to inquire into the working of the Metropolitan Board of Works, he was elected president of this commission. In 1892 he was again Lord Chancellor under Gladstone, and in 1894-95 under Rosebery. He was chosen chancellor of the University of London in 1893. In 1897 he was a member of the British Guiana and Venezuela Boundary Arbitration Tribunal; and in 1898-99 chairman of the Canadian-American Joint High Commission. Died in Washington, D. C., March 1, 1899.

HERTSLET, SIR EDWARD, a British diplomat and author; born in London, Feb. 3, 1824; educated at private schools; entered the Foreign Office, 1840. He was attached to the special embassy of the Earl of Beaconsfield and the Marquis of Salisbury to the Congress of Berlin in 1878; was one of the delegates appointed in June, 1880, to settle the boundary between Dutch and British Borneo; and was knighted in 1892. He published *Hertslet's Commercial Treaties* (1875-79); *British and Foreign State Papers; The Map of Europe by Treaty* (1891); and *The Foreign Office List*.

HERTZ, HEINRICH, a German electrician, discoverer of the so-called Hertzian waves or rays; born in Hamburg, Feb. 22, 1857; took his degree at Berlin in 1880, when he became assistant to Helmholtz; became professor of physics at Bonn in 1889. His investigations were directed principally to electrical phenomena. He attracted the attention of the whole scientific world in 1890, by a paper on the relations between light and elec-

tricity. His researches were collected and published under the title, *Die Ausbreitung der Elektrischen Kraft*. He died in Bonn, Jan. 1, 1894.

HERTZ, WILHELM, a German poet; born in Stuttgart, Sept. 24, 1835; studied philology at the University of Tübingen; served in the army of Württemberg, and then traveled in France and England. He became professor of German in the technical school at Munich in 1869. He published epics and poems of the middle ages, *Lancelot and Ginevra* (1860); *Marie de France* (1862); *Tristan et Isolde* (1877); *A Legend of the Convent Bruder Rausch* (1882); and *Lager in Alsace* (1872).

HERVÉ, AIMÉ MARIE EDOUARD, a French journalist; born in St. Denis, Réunion island, May 28, 1835. In 1854 he entered the normal school, but sent in his resignation shortly afterward, in order that he might devote his undivided attention to journalism. He was connected with several journals until 1867, when, after the publication of the imperial letter of Jan. 19, 1867, inaugurating a new system for the press, Hervé established, in conjunction with M. Jean Jacques Weiss, the *Journal de Paris*, which became noted for its persistent attacks on the imperial régime. At the general election of May, 1869, Hervé came forward in the circonscription of Arras, as the candidate of the Liberal opposition, under the patronage of Thiers, but he was defeated at the poll by the official candidate, Sens. Weiss having retired from the strife of political journalism on being nominated general secretary of the Ministry of Fine Arts, Hervé remained sole editor of the *Journal de Paris*, and on Feb. 5, 1873, started the *Soleil*. After the visit of the Comte de Paris to Frohsdorff, which preceded the attempt to re-establish the ancient monarchy, Hervé proclaimed loudly "the reconciliation of the House of France," and engaged, with reference to this subject, in an animated controversy with Edmond About, the editor of the *Dix-Neuvième Siècle*. This dispute ended in a duel, in which About was slightly wounded. After the proclamation of the septennate, Hervé supported the policy of the Broglie, Cissy, and Buffet cabinets. The *Journal de Paris* was discontinued in 1876, and he remained editor of the *Soleil*. He wrote *A Page of Contemporary History* (1869), and a *History of the Irish Crisis* (1885). Died in Paris, Jan. 4, 1899.

HERVEY ARCHIPELAGO. See COOK'S ISLANDS, Vol. VI, p. 331.

HERWARTH VON BITTENFELD, KARL EBERHARD, a Prussian general; born at Grosswerther, Sept. 4, 1796. He entered the military service in 1811, and gained his first laurels in the war of liberation, especially in the battle of Leipzig. In 1863 he was promoted to the rank of general, and in 1864 commanded the Prussian troops against Denmark, distinguishing himself by his daring capture of the Isle of Alsén. In the campaign of 1866 he was intrusted with the occupation of Saxony, and then with the command of the army, which advanced from Saxony into Bohemia. He gained victories at Hühnerwasser and Münchengrätz, and took a prominent part in the

battle of Königgrätz. In 1870, on the outbreak of the Franco-German War, he was made governor of the Rhine provinces, and in 1871 a general field-marshal. He retired from active service April 8, 1871, and died at Bonn, Jan. 14, 1884.

HERZ, HENRI, a French pianist and composer; born of Jewish parentage at Vienna in 1806, and educated in Paris, where his talent was recognized early. His compositions became popular over Europe, and he was received with applause on visiting England in 1834 and America in 1846. In 1837 he received the decoration of the Legion of Honor, and from 1842 till 1874 he was professor of music at the Conservatory of Paris. He was also manager of a pianoforte factory, and in 1855 his pianofortes won the first prize at the Paris Exhibition. His compositions, more than two hundred in number, are mostly for the piano. He died Jan. 6, 1888.

HERZEN, ALEXANDER, an Italian physiologist; born at Vladimir, Russia, June 25, 1839; educated in England; studied medicine at Berne; became assistant to Schiff in Florence, and was called to Lausanne in 1881. He published many works on physiology and physiological psychology, among them, *Analisi Fisiologica del Libero Arbitrio Umano* (1870); and *Le Cerveau et l'Activité Cérébrale* (1886).

HERZOG, JOHANN JAKOB, a German theologian; born at Basel, Sept. 12, 1805. He studied theology in his native city and in Berlin, became professor at Lausanne in 1830, at Halle in 1847, and at Erlangen in 1854, retiring in 1877. Among his works are *Calvin* (1843); *Das Leben Cœcolampadii* (1843); *Die Romanischen Waldenser* (1853); but his name is best known for the great theological encyclopædia edited by him, *Realencyklopädie für Protestantische Theologie und Kirche* (22 vols., 1854-68). He died at Erlangen, Sept. 30, 1882.

HESPERIS OR ROCKET. See HORTICULTURE, Vol. XII, p. 251.

HESPERORNIS, fossil swimming-bird. See ORNITHOLOGY, Vol. XVIII, pp. 36, 37.

HESSE, the name generally applied to Hesse-Darmstadt, a grand-duchy of the German Empire. Area, 2,966 square miles; population (1895), 1,039,020. Capital, Darmstadt. For history, productions, and early statistics, see Vol. XI, pp. 779-80.

The former landgraves of Hesse had the title of grand-duke given to them by Napoleon I in 1806, together with a considerable increase of territory. At the Congress of Vienna this grant was confirmed, after some negotiations. The reigning family is not possessed of much private property, but dependent almost entirely upon the grant of the civil list, amounting to 1,331,857 marks, the sum including allowances to the princes.

The executive is assisted by a ministry, divided at present into three departments, viz.: of the grand-ducal house and foreign affairs and of the interior; of justice; and of finance.

The largest towns of the grand-duchy are Mayence, or Mainz, with a population, in 1895, of 76,946; Darmstadt, 63,745 (including Bessungen); Offenbach, 39,408; Worms, 28,636; Giessen, 22,924.

Of the population on Dec. 2, 1895, there were,

Protestants, 68 per cent; Roman Catholics, 30 per cent; Jews, 2 per cent, and the remainder unclassified.

The public debt in 1898 was \$56,877,150. The revenue for each of the three years, 1897-1900, was estimated at \$8,903,851, and the expenditure at \$8,913,390.

HESSE-NASSAU. See HESSE, Vol. XI, p. 779.

HESSIAN-FLY (*Cecidomyxia destructor*), a popular name for one of the gall-midges, which has been very destructive to wheat in the United States and to some extent in Europe. The perfect insects emerge from the pupæ in autumn and deposit their eggs on young plants of winter wheat. The eggs develop, and winter is passed in the pupa stage. The popular name was given because the Hessian troops were supposed to have brought the insects in their baggage in 1776, but there is no foundation for this belief.

HETAERISTS, Greek revolutionists. See ROMANIA, Vol. XXI, p. 20.

HETEROCERA. See INSECTS, Vol. XIII, p. 151.

HETEROCERCAL (Gr., *heteros*, "different," "unequal," and *kerkos*, "a tail"), a term introduced by Agassiz, to designate the unsymmetrical tail of fishes, in which the vertebral axis is bent upward in the tail, making the upper lobe much the larger, and the lower lobe is placed at a distance from the extremity. A heterocercal tail is found in sharks (*Elasmobranchii*), chimæras (*Holocephali*) and in certain ganoid fishes. This type of tail is a modification of a simple type in which the vertebral axis is straight, and the dorsal and ventral lobes are equal (diphycercal). The outwardly symmetrical tail (homocercal) of most bony fishes is a modification of the heterocercal.

HETERODONTIDÆ, a family of sharks, in geologic times numerous, now represented by a few living genera, among which is the Port Jackson shark (*Heterodontus philippi*). There is one representative on the western coast of the United States. The term *cestraciontida* is synonymous. See SHARK, Vol. XXI, p. 775.

HETEROGAMY, a botanical term indicating that the gametes concerned in the sexual act are unlike. All higher plants are heterogamous; while the transition from *isogamy* (similar gametes) to heterogamy is very evident among the algæ.

HETEROGONY, a botanical term signifying dissimilar reproductive organs, and applied to that condition of flowers in which stamens and pistils are of reciprocal lengths. In *Houstonia*, for example, some flowers have short stamens and long styles, while others have long stamens and short styles. The arrangement is such that pollen from the short stamens, through insect agency, reaches the short styles, and pollen from the long stamens reaches the long styles. The pollen is impotent, or nearly so, upon any style not the length of the stamen. In case there are two kinds of flowers thus reciprocally related, as in *Houstonia*, it is said to be a case of *dimorphism*; in *Lythrum Salicaria* the flowers are *trimorphous*, three kinds of flowers, different as to the lengths of stamens and styles, manifesting reciprocal relations.

HETEROPODA, a group of marine gasteropod mollusks, abundant in the warmer seas. Their most peculiar feature is the foot, which is expanded to form a leaf-like fin. They swim near the surface of the water, with the ventral side uppermost. The animals are quite transparent. The nervous system is more highly developed than in any other gasteropod. The peculiarities of the heteropods formerly caused them to be considered a separate order, but recent authors unite them with the prosobranchiate gasteropods. The term *Natantia* is equivalent; under which, see MOLLUSCA, Vol. XVI, p. 653.

HETEROPTERA. See HEMIPTERA, Vol. XI, p. 646; and INSECTS, Vol. XIII, p. 153.

HETEROPYGIA GROUP. See MAMMOTH CAVE, Vol. XV, p. 450; also ICHTHYOLOGY, Vol. XII, p. 693.

HETEROSOMATA, a suborder of fishes, which, unlike most other vertebrates, are asymmetrical with respect to their external form. The body is greatly compressed laterally, and one side is almost uncolored; the other is dark. The eyes of the adult are on the dark side. The fish lies on the bottom, and on the white side of the body. The young fish is as symmetrical as most other fishes, with an eye on either side. Later, it begins to lie on the bottom, and one eye gradually shifts to the side occupied by its fellow. The fishes of this group are popularly known as flat-fishes. There are two families, the *Pleuronectide* and the *Soleiide*. The former includes the flounders, halibut, turbot, plaice, etc., while the latter includes the sole and related fishes.

HETEROSPORY, a botanical term signifying the production by the Sporophyte of two kinds of spores, one of the most fundamental facts of the plant kingdom. The larger spore is known as the *macrospore*, and produces the female gametophyte; the smaller spore is known as the *microspore*, and produces the male gametophyte. Heterospory appears first in the higher Pteridophytes, or fern-plants, and characterizes all of the Spermatophytes, or seed-plants. In the latter group it results in the formation of the structure known as the seed, the macrospore being retained instead of being shed, as in the lower groups. The microspores in the seed-plants have long been known as pollen-grains, and the macrospores as the embryo-sacs of the ovules.

HET-HOR OR HATHOR. See ATHOR, Vol. III, p. 13.

HETMAN OR ATAMAN, the title of the head of the Cossacks, now retained only among the Cossacks of the Don. From earliest times the office was elective, and might be held by any member of the tribe. His power was very great, extending over life and death. In 1654 the office was suppressed among the Ukraine. The office gradually came under royal control, and is now the hereditary title of the heir to the throne.

HEWES, JOSEPH, a signer of the Declaration of Independence; born in Kingston, New Jersey, 1730. In 1774 he was a delegate to the Continental Congress. He belonged to the Society of Friends, and when this society denounced the proceedings of Congress he severed his connection with it, and became even a promoter of war. In 1776 he was

one of the signers of the Declaration of Independence, and was at the head of the naval committee. Hewes declined a re-election in 1777, but resumed his seat in Congress in 1779. He died in Philadelphia, Nov. 10, 1779.

HEWIT, AUGUSTINE FRANCIS (baptized NATHANIEL AUGUSTUS), an American clergyman; born at Fairfield, Connecticut, Nov. 27, 1820. He studied theology at East Windsor, Connecticut, and in 1843 was ordained deacon in the Protestant Episcopal Church; became a Roman Catholic, and was ordained in that church in 1847 by Bishop Reynolds. Hewit thereupon was appointed vice-principal of the Charleston Collegiate Institute. He joined the order of the Redemptorists in 1850, and in 1858, on the foundation of the congregation of St. Paul by Father Hecker, Hewit became one of its chief members, taking the religious name of Augustine Francis. He was appointed professor of philosophy, theology and Holy Scriptures in the Paulist Seminary in New York City in 1865. From 1869 till 1874 he edited the *Catholic World*. He was active as an author, and published *Reasons for Submitting to the Catholic Church* (1846); *Life of Princess Borghese* (1856); *Problems of the Age* (1868); *Light in Darkness* (1871); *The King's Highway* (1874); and many other works. Died at New York, July 3, 1897.

HEWIT, NATHANIEL, an American clergyman; born in New London, Connecticut, Aug. 28, 1788; studied divinity at Andover, and was licensed in 1815; preached till 1827, when he took up temperance work. He was very successful, and was called the "Luther of the early temperance reforms." In 1830 he returned to preaching. He was in England from 1831 to 1834 on temperance work. He was a founder of the Hartford Theological Seminary. He died in Bridgeport, Connecticut, Feb. 3, 1867.

HEWITT, ABRAM STEVENS, an American statesman; born at Haverstraw, New York, July 31, 1822.



ABRAM S. HEWITT.

After graduating at Columbia College, he studied law, and was admitted to the bar in 1845. His impaired eyesight soon made him give up the practice of law, and he became associated with Peter Cooper in the manufacture of iron. The firm of Cooper and Hewitt became the owners of the Trenton, Ringwood, Pequest and Durham iron works. He was a commissioner to the French exhibition of 1867, and made a report on iron and steel. He married Peter Cooper's daughter, and was secretary of the Cooper Union for the Advancement of Science and Art after its incorporation in 1859; was elected to Congress in 1874 as a Democrat, and served continuously, with the exception of one term, until 1886; advocated moderate tariff reform. In 1886 he was elected mayor of New York City. In this office he enforced the laws strictly and held the heads of the departments strictly accountable. In 1887 Columbia College gave him the degree of LL.D.

on account of his expert knowledge in the manufacture of iron.

HEXACORALLA, coral insects. See ACTINOZOA, Vol. I, p. 130.

HEXAMETER, the name applied to the most important form of classical verse. It is the heroic or epic verse of the Greeks and Romans, the grandest examples of which are the *Iliad* and *Odyssey* in Greek and the *Æneid* in Latin. It consists of six feet, or measures, the last of which must be a spondee (a measure composed of two long syllables), and the penultimate a dactyl (one long syllable and two short). If the penultimate is also a spondee, the verse is said to be spondaic. The verse consists of two cola or numbers, and hence has a verse-cæsure, which regularly falls in the third foot, after the first long, or between the two short syllables, but seldom after the first long of the fourth foot. Klopstock, Goethe and Voss have produced admirable specimens of hexameter verse in German, and it has become familiar in English through Longfellow's *Evangeline*. The following lines from the last show the only varieties of the hexameter which are endurable to the ear—that is, those in which the accent on each foot falls on its first syllable:

"Felt she in | myriad | springs her | sources | far in the |  
mountains,  
Stirring, col | lecting, | heaving up, | rising, | forth | out |  
flowing."

It will be observed that on whatever syllable here the metrical accent falls, that syllable is precisely the same which the voice naturally accentuates. Whether this was the case in ancient Greek and Latin hexameters we do not know; but, if the present system of Greek accentuation represents the natural accent of Homeric words, Homer disregarded the natural accents, or did not observe our rule of always placing the metrical accent on the first syllable of each foot. We still pronounce Latin hexameters by preserving what we take to be the natural accent of each word, whether that corresponds to the metrical accent or not. Thus, in the line—

"Itali | am fa | to profu | gus La | viniaque | venit,"

we disregard the metrical accent, which should fall on the first syllable of each foot (and actually does so on the fifth and sixth), and in reading the line give effect to the natural accents only, as we conceive them, in the words *Italiam, fato, profugus*.

When English hexameters were first written they were constructed in the same manner: the natural accent, except in the last two feet, overruled the metrical. In the following lines from Stanihurst's translation of the *Æneid*, it will at once be seen that the effect is absurd if we read the lines as modern English hexameters are read:

"Either here | are crouch | ing some | troops of | Greekish  
as | ssembly,  
Or to crush | our bul | warks this | work is | forgéd, all—  
houses  
For to pry, | surmount | ing the | town; some | practice  
or other  
Here lurks | of cun | ning; trust | not | this | treacherous  
ensign."

If we read by the natural accent, the effect is rough and harsh to the ear; if by the modern metrical, ridiculous and absurd. Such are the limitations of the hexameter in English.

HEXAPLA. See BIBLE, Vol. III, p. 646.

HEXATEUCH. See PENTATEUCH, Vol. XVIII, p. 506.

HEYSE, PAUL JOHANN LUDWIG, a German author; born in Berlin, March 15, 1830; educated there and at Bonn. He was one of the band of authors whom King Max of Bavaria gathered around him in Munich in 1854. He published more than a score of collections of novelettes under various titles, good specimens of which are contained in *Das Buch der Freundschaft* (1883-84). His poetic works include narrative poems, such as *Urica* (1852); and epics, such as *Die Braut von Cypern* (1856); and *Thekla* (1858). His miscellaneous poems are collected in *Das Skizzenbuch* (1877); *Der Salamander, ein Tagebuch in Terzinen* (1879); and *Verse aus Italien* (1880). As a dramatist he proved quite a voluminous but scarcely a successful writer. Among his dramas are *Francesca da Rimini* (1850); *Ehre um Ehre* (1875); *Die Weiber von Schorndorf* (1881); and *Getrennte Welten* (1886). He wrote two more ambitious novels, *Die Kinder der Welt* (1873), and *Im Paradiese* (1875), which have been very popular; and translated the poetical works of Giusti, of Leopardi, and of Parini, Monti and Manzini.

HEYWARD, THOMAS, JR., an American statesman; born in St. Luke's Parish, South Carolina, 1746. He studied law in the Temple, in London. After returning home he was elected to the Continental Congress of 1775, and became one of the signers of the Declaration of Independence. In 1778 he was appointed judge of the criminal and circuit court of South Carolina. At the siege of Charleston, May 12, 1780, he was taken prisoner and sent to St. Augustine, Florida, where he was confined one year. After his release he resumed his office as state judge. In 1790 he was a member of the constitutional convention, and then retired to his plantation. Died in St. Luke's Parish, March 6, 1809.

HEYWOOD, JAMES, an English writer; born at Manchester, May 28, 1810; was educated at Trinity College, Cambridge, where he was a senior optime in 1833, but did not graduate until 1857. He studied but never practiced law; was a member for North Lancashire in 1847, and from that time till 1856 succeeded in passing several reform bills regarding educational institutions; and, after removal of religious tests from degrees in arts, law, medicine and music at Cambridge, took his degree. He resided for many years at Kensington, and presented his free library to that parish. He published, among other works, *The History of University Subscription Tests* (1853); *The Early Cambridge Statutes* (1855); and edited Professor Heer's *Primæval World of Switzerland* (1881).

HIAWATHA, a city and the capital of Brown County, northeastern Kansas, 40 miles W. of St. Joseph, Missouri, on the Missouri Pacific and the St. Joseph and Grand Island railroads. It is in an agricultural and stock-raising region, and has grain-elevators and flour-mills; it also has an academy and

a public library. Population 1890, 2,486; 1900, 2,829.

HIBBERT, SIR JOHN TOMLINSON, an English politician; born at Oldham, 1824; was educated at Cambridge, and studied law; entered politics as a Liberal in 1859 and was defeated in Oldham, but was successful in 1862. From that time till 1874 he represented the same borough, but was defeated in 1874; regained his seat in 1877 and held it till 1886, when he was again defeated; was returned in 1892, but not in 1894. In 1883 he was appointed Under-Secretary at the Home Office, and in 1885 Financial Secretary to the Treasury, which office he again held after the elections of 1892 and 1894. He was chairman of the Council of the County Palatinate of Lancaster and of the County Councils Association.

HIBERNIANS OF AMERICA, ANCIENT ORDER OF. See BENEFIT SOCIETIES, in these Supplements.

HIBISCUS, genus of showy plants. See HORTICULTURE, Vol. XII, p. 251; and GUMBO, Vol. XI, p. 276.

HICKMAN, a city and the capital of Fulton County, western Kentucky, on the Mississippi River, 40 miles below Cairo, Illinois, on the Nashville, Chattanooga and St. Louis railroad. It contains a college, town library and manufactories of flour, wagons, stoves, lumber and boxes. Population 1890, 1,652; 1900, 1,589.

HICKOK, LAURENS PERSEUS, an American clergyman and philosopher; born at Bethel, Connecticut, Dec. 29, 1798. After studying theology he became successively pastor at Newton, Kent and Litchfield, Connecticut, from 1822 to 1836. In the latter year he was appointed professor of theology in the Western Reserve College, and in 1844 professor of the same branch in the Auburn Theological Seminary. In 1852 he removed to Schenectady, New York, to become professor of mental and moral science and vice-president of Union College there. From 1860 to 1866 Dr. Hickok had full charge, and was then elected president of the same college. At the age of seventy Dr. Hickok retired to Amherst, Massachusetts, where he devoted himself to philosophical studies. He published *Rational Philosophy* (1848); *System of Moral Science* (1853); *Empirical Psychology* (1854); *Rational Cosmology* (1858); *Creator and Creation* (1872). He died at Amherst, May 6, 1888.

HICKORY, a town of Catawba County, western North Carolina, on the Chester and Lenoir and the Southern railroads, 48 miles N.W. of Charlotte, near the Catawba River. The district is very fertile, and abounds in iron ore; corn, wheat, tobacco and cotton are exported. The town contains the Claremont Female College, Lenoir College, St. Paul's Seminary and Meade School for Boys. Population 1890, 2,023; 1900, 2,535.

HICKS, HENRY, a British geologist; born in St. David's, Pembrokeshire, England, in 1837; was educated at the collegiate and chapter school in his native place, and at Guy's Hospital, London. Practiced medicine at St. David's from 1862 to 1871, during which period he commenced his geological researches. He carried on valuable investigations

in North Wales and England, confining his attention, in later years, to the oldest rocks, and proved their existence in many places where their presence was unsuspected; published evidence tending to show that men occupied the caverns during a part of the glacial period, and did much other glacial work. He published several articles, and prepared a geological map of North Wales. He was president of the London Geologist Association; elected a fellow of the Royal Society, and connected with many other geological societies.

HICKS, THOMAS, an American portrait-painter; born at Newton, Bucks County, Pennsylvania, Oct. 18, 1823; studied at the Pennsylvania Academy of Fine Arts in Philadelphia, at the National Academy in New York, and later in London, Rome, Florence and Paris. In 1850 he settled in New York, and a year later became prominent in the Academy. He painted many celebrated persons, among them being President Lincoln, W. H. Seward, O. W. Holmes, Mrs. Harriet Beecher Stowe and Edwin Booth. Died at Trenton Falls, New York, Oct. 8, 1890.

HICKS, WILLIAM MITCHINSON, a British physicist; born at Lancelton, England, Sept. 23, 1850; was educated at St. John's College, Cambridge, and was elected fellow of the same college in 1876, holding the fellowship six years. In 1883 he became principal and professor of mathematics and physics at Firth College, Sheffield; became a fellow of the Royal Society in 1885, and was author of several papers published in the *Transactions of the Royal Society*. Among them are *On the Motion of Two Spheres in a Fluid* (1879); *On Toroidal Functions* (1881); *Researches in the Theory of Vortex Rings* (1885); read before the British Association a *Report on Recent Progress in Hydronamics*; author of *Elementary Dynamics of Particles and Solids* (1889); and contributed to various journals.

HICKS-BEACH, SIR MICHAEL EDWARD, a British statesman; born in London in 1837; finished his education at Oxford in 1861; was elected to Parliament for East Gloucestershire in 1864, and retained his seat until 1885, when he was returned for West Bristol, which he still represents; served as Under-Secretary for the Home Office till 1868, and consecutively as Chief Secretary for Ireland (1874), and Secretary of State for the Colonies (1878); was Chancellor of the Exchequer and leader of the House of Commons in the first Salisbury administration; and when Salisbury returned to power, in 1886, Hicks-Beach became again Chief Secretary for Ireland, but resigned in a few months on account of failing eyesight. From 1887 to 1892 he was president of the Board of Trade; was made Church Estates Commissioner in 1893, and Chancellor of the Exchequer in 1895. He served on the Royal Commissions, on Friendly Societies, on Industrial Schools, on Labor and on Reformatory.

HICKSITES, followers of Elias Hicks. See QUAKERS, Vol. XX, p. 149; and FRIENDS, SOCIETY OF, in these Supplements.

HICKSVILLE, a village of Defiance County, northwestern Ohio, on the Baltimore and Ohio railroad, 20 miles W. of Defiance. It is surrounded by a farming and lumbering district. It has furniture-

works, planing and wagon works, and produces various kinds of wooden articles. Population 1890, 2,141; 1900, 2,520.

HIDALGO, a state of central Mexico, between lat. 19° 30' and 21° 30' N., and between long. 98° and 100° W. Its surface is mountainous in the northern and eastern parts, the highest point being Cerro Canjardo, 9,380 feet in height. It is drained by the Octapan, the San Juan and the Amajaque rivers. The most common agricultural products are maize, wheat, barley, rice, cotton, sugar-cane, beans, peas and sarsaparilla; and pulque, a Mexican beverage, is produced in large quantities here. In mining resources the state is rich, producing gold, silver, copper, iron and lead in abundance, the annual mineral product being valued at over \$5,000,000. Capital, Pachuca, of which the population is 40,500. Population of the state, by the official estimate of 1893, 506,028; area, 8,917 square miles.

HIDALGO, Y COSTILLA, DON MIGUEL, a Mexican patriot; born in Mexico, May 8, 1753. He studied at Valladolid, and in 1779 went to the City of Mexico, where he became a priest. In December, 1809, a conspiracy was formed at Valladolid against the Spanish government of Mexico; of this, Hidalgo was a member. After some preliminary disturbances, Hidalgo issued a declaration of independence to the people of Suevavato. He was quickly surrounded by a mob of almost unarmed men, which had swelled to 50,000 when he reached Guanajuato, which place he stormed, and, in accordance with the fashion of Indian warfare, massacred the inhabitants. After establishing a cannon foundry and mint, he marched against Valladolid and occupied it without much resistance. Having been excommunicated by the archbishop, many of his plundering followers deserted, and on December 2d Hidalgo began his retreat. On the 7th his body of troops and pillagers were attacked near Acula, by General Callega, and the greater part dispersed. Hidalgo then took refuge in Valladolid. Here he organized a government and prepared to resist the Spanish forces. On Jan. 17, 1811, 6,000 Spanish troops attacked the mob of 100,000 armed natives and won a complete victory. He, with several of his officers, tried to escape to the United States, but were betrayed by a companion-in-arms. On July 29th Hidalgo was degraded from his sacerdotal character, and executed on the following day at Chihuahua, 1811.

HIDES. See LEATHER, Vol. XIV, p. 380.

HIDEYOSHI, Japanese general and statesman. See JAPAN, Vol. XIII, p. 583.

HIEL, EMANUEL, a Belgian poet; born at Den-dermonde, May 31, 1834. After holding various positions in business houses he finally secured a post in the Ministry of the Interior, and in a short time was appointed professor of declamation in the Conservatory of Music at Brussels; also, librarian of the Industrial Museum. Among his poetical publications of interest are the following: *Gedichten* (1863); *Bloemcken een Liederkrans* (1877). His miscellaneous writings include dramatic poems, *Jacoba Van Beieren* (1879), and *Bloemardinne* (1877); children's poems, *Liederen voor Groote en Kleinkinderen*; *De Schelde*; and others, written for music. In 1880, at



the anniversary of Belgian independence, he wrote *Belgenland* and *Eer Belgenland*.

HIEROMAX. See PALESTINE, Vol. XVIII, p. 173.

HIERONYMUS. See JEROME, SAINT, Vol. XIII, p. 630.

HIERONYMUS, tyrant. See SYRACUSE, Vol. XXII, p. 817.

HIGGINSON, FRANCIS, a New England clergyman; born in England in 1588. He was a Puritan preacher of great influence in Leicester, England. In 1628 he was invited by the Massachusetts Bay Company to accompany its expedition to New England. He arrived at Salem on June 29, 1629, and was soon after chosen teacher of the congregation. He drew up a confession of faith, which was assented to by thirty persons. During the ensuing winter he was attacked by a fever, which disabled him and finally caused his death. He wrote *New England's Plantation: or, A Short Description of the Commodities of that Country* (1630). He died in Salem, Massachusetts, in 1630.

HIGGINSON, THOMAS WENTWORTH, an American author; born in Cambridge, Massachusetts, Dec. 22, 1823, being a lineal descendant of Francis Higginson, first minister at Salem (1629); graduated at Harvard in 1841, and at the Divinity School of that university in 1847; settled at Newburyport, and afterward took charge of a liberal Unitarian parish in Worcester, but resigned and left the ministry in 1858. He took an active part in the anti-



THOMAS W. HIGGINSON.

slavery agitation, and, together with Theodore Parker, Wendell Phillips and others, engaged in an attempt to rescue Anthony Burns, arrested in Boston under the fugitive slave law, in 1854. For this assault Higginson was indicted, escaping trial only through a legal technicality. In 1856 he joined the Free-State forces in Kansas, being made a brigadier-general and bearing a conspicuous part in the effort to exclude slavery from the new commonwealth. Upon the breaking out of the Civil War, his ardent support of the Union finally led him to take the field as captain in a Massachusetts regiment of volunteers. Subsequently he was appointed to the command of the first colored regiment of freed slaves raised in the United States service, its ranks including many former slaves from Pierce Butler's plantation on St. Simon's Island, Georgia. During a Florida campaign in 1863 he was disabled by a wound received in the capture of Jacksonville, and compelled to retire from the service. He now devoted himself largely to literature, although taking a warm interest in public affairs, being chosen to the Massachusetts legislature in 1880-81, and serving upon the staff of Governor John D. Long, as well as on the state board of education. He contributed many papers to the *Atlantic Monthly*, afterward collected under various titles, and has always been especially ardent

in his advocacy of woman's rights and health reform. He has published several poems of merit, together with felicitous translations from Petrarch. Among his earlier essays may be mentioned *A Charge with Prince Rupert*, as indicating a talent for historic narrative, afterward developed in histories of America, by which as a writer he is widely known. His works include *Woman and her Wishes* (1863); *Out-door Papers* (1863); *The Works of Epictetus* (1865), an admirable revision of Elizabeth Carter's translation; *Harvard Memorial Biographies* (1867, edited); *Malbone: An Oldport Romance* (1869); *Army Life in a Black Regiment* (1869); *Oldport Days* (1873); *Young Folks' History of the United States* (1875), translated into French and German; *A Book of American Explorers* (1877); a biography, *Margaret Fuller Ossoli* (1884); *Larger History of the United States* (1885); *Women and Men* (1888); *Tales of the Enchanted Isles of the Atlantic* (1898); besides many separate essays. He is state historian of Massachusetts, and a constant contributor to various periodicals, possessing a cultivated, graceful style, a scholarly grasp of letters, and the courage of his convictions.

HIGGINSVILLE, a village of Lafayette County, northwestern central Missouri; on the Chicago and Alton and the Missouri Pacific railroads, 48 miles east of Kansas City. It is a trading and shipping center for a wheat-growing section, sending off corn and other produce, and also some coal. A Confederate home is located here. Population 1890, 2,342; 1900, 2,791.

HIGHER CRITICISM. See CRITICISM, in these Supplements.

HIGHLAND, a city of Madison County, southwestern central Illinois, on the Terre Haute and Indianapolis railroad, 22 miles east of East St. Louis. It has a Roman Catholic University, woolen and flour mills, and a foundry, brewery and machine-shop; manufactures condensed milk and embroidery. Many Germans and Swiss reside here. Population 1890, 1,857; 1900, 1,970.

HIGHLAND, a town of Ulster County, southeastern New York, on the Hudson River and the West Shore and the Philadelphia, Reading and New England railroads. It contains flour-mills, felloe factories and fruit-package factories. It has daily steamboat connections with Albany, Newburg and New York. Fruit, especially grapes, is raised in the vicinity. Population 1890, 1,570.

HIGHLAND FALLS, a village of Orange County, southeastern New York, on the Hudson River and the West Shore railroads, 46 miles north of the Battery, New York City. It is a summer resort, and has many fine residences of New York business men. West Point and the United States Military Academy grounds are just to the north. Population 1900, 4,510.

HIGHLAND PARK, a city of Lake County, northeastern Illinois, a suburb of Chicago, 22 miles north of the City Hall. It has many summer residences of Chicago business men, and has several educational institutions, including the Northwestern Military Academy, Deerfield Township High School and Sylvan Dell's School for Boys. It is connected with Chicago by the Chicago and Northwestern railroad. Population 1890, 2,163; 1900, 2,806.

**HIGHLAND REGIMENTS**, regiments originally raised in the north of Scotland. There are nine in the British army, of whom five wear the national costume. The first Highland regiment was organized in 1739. See **ARMY**, Vol. II, p. 580, and **BLACK WATCH**, in these Supplements.

**HIGHLANDS**, a city of Arapahoe County, northeastern Colorado, on the South Platte River, opposite Denver. It is a suburb of Denver, on the Union Pacific railroad. Population 1890, 5,161. It has since been annexed by Denver.

**HIGHLANDS OF THE HUDSON**. See **HUDSON RIVER**, Vol. XII, p. 331.

**HIGH-LEVEL BRIDGE**, at Halifax, England, opened in 1890, was built to provide railway accommodation for the upper part of the town, which is 400 feet higher than the station of the Lancashire and Yorkshire railway. The line ascends in a ruling gradient of one foot in fifty, with sharp curves and several deep cuttings; there are also a tunnel of 820 yards, a viaduct of ten spans of 50 feet each, and a number of bridges. The total length is three and one-half miles, and there are two stations. The cost was \$1,500,000.

**HIGH MISDEMEANOR**, an offense closely bordering on treason. See *Cognate Offenses*, under **TREASON**, Vol. XXIII, pp. 528, 529.

**HIGH POTENTIAL DISCHARGE**. See **ELECTRICITY** §94, in these Supplements.

**HIGH PRIEST**. See **PENTATEUCH**, Vol. XVIII, p. 510.

**HIGH SEAS**, the open sea, including the whole extent of sea, not the exclusive property of any particular country. The rule of international law is that every country bordering on the sea has the exclusive sovereignty over such sea to the extent of three miles from its shores, all beyond being common to all countries. The part of the sea within three miles distance is generally called the territorial sea of the particular country, or *mare clausum*. The distinction has little effect on the right of navigation, but as regards fishing it is otherwise.

**HIGHTSTOWN**, a post borough of Mercer County, central New Jersey, 13 miles E.N.E. of Trenton, on the Pennsylvania railroad. It contains three educational institutions, including Peddie (Baptist) Institute, with 200 students, and manufactories of plows, chains and doors. Population 1895, 1,875; 1900, 1,749.

**HIJAZ**. See **ARABIA**, Vol. II, pp. 236-253, and **HEDJAZ EL HEJAZ** in these Supplements.

**HIJRA OR HEGIRA**. See **MOHAMMEDANISM**, Vol. XVI, pp. 545-551, and **CHRONOLOGY**, Vol. V, p. 717.

**HILARY**. See **HILARIUS**, Vol. XI, p. 812.

**HILDEBRAND**. See **GREGORY VII**, Vol. XI, pp. 176, 177.

**HILDEBRAND, HANS OLOF**, a Swedish archæologist; born in Stockholm, Sweden, April 5, 1842. He was educated at Upsala; was attached to the Museum of Archæology, and in 1879 succeeded his father in the post of royal antiquarian and guardian of the medals; founded the Society of Archæology, and did much to popularize archæ-

ological research concerning his own country. He has published, among other things, *The Swedish People During Pagan Times* (1866); *Life in Iceland During the Saga Times* (1867); *Prehistoric Nations in Europe* (1873-80); a collection of essays *From Ancient Times*; and with his father, Bror Emil Hildebrand, he prepared several volumes of plates of designs from the Historical Museum of the Swedish state.

**HILES, HENRY**, an English musician; born at Shrewsbury, England, Dec. 31, 1826; held various organ appointments in England, and in 1880 was appointed lecturer on harmony and musical composition at Owens College, Manchester, a position he still holds, together with a like position in Victoria University. Besides, he is director of several musical societies. He gained prizes for the best organ composition in 1864, 1865 and 1868 from the College of Organists. In 1878 he received the prize for the best serious glee, from the Manchester Gentlemen's Glee Club. Among his works are *The Grammar of Music; Part-Writing, or Modern Counterpart*; and has composed *The Crusaders; War in the Household*, and other works.

**HILGARD, EUGENE WOLDEMAR**, an American chemist; born at Zweibrücken, Bavaria, Jan. 5, 1833. He studied at the Royal Mining Academy in Freiburg, Saxony, at the Universities of Zürich and Heidelberg. In 1857 he became assistant state geologist of Mississippi, and in 1857 he was appointed chemist in charge of the laboratory of the Smithsonian Institution, and filled also the chair of chemistry in the National Medical College at Washington. From 1858 to 1866 he was state geologist of Mississippi, and till 1873 also professor of agricultural chemistry in the State University there. In 1873 he was called to the chair of geology and natural history in the University of Michigan, and in 1875 to the professorship of agricultural chemistry and botany in the University of California, where he has since remained. During 1881-83 he had charge of the agricultural division of the northern transcontinental survey; wrote various geological articles for the government, and in 1892 prepared for the weather bureau, a report on the relation of soils and climate, which became well known abroad, being translated into several languages.

**HILGARD, JULIUS ERASMUS**, an American engineer and scientist; born in Zweibrücken, Bavaria, Jan. 7, 1825. From 1843 to 1845 he studied civil engineering in Philadelphia. In the latter year he became one of Alexander D. Bache's assistants on the coast survey, and soon rose to the office of assistant in charge of the bureau at Washington. This place he held until the death of the superintendent in 1881, when he was appointed to fill the vacancy. Hilgard also had charge of the United States standard weights and measures, and in 1872 he was made a delegate to the International Metric Commission which met at Paris. In 1885, on the advent of Cleveland's administration, he was suspended, and then permitted to resign. Professor Hilgard's work in terrestrial physics, geodesy, the magnetic survey

of the United States, tidal action in harbors, etc., and his papers and lectures on these topics, are of considerable scientific importance. He died in Washington, May 8, 1891.

HILGARD, THEODORE ERASMUS, a German lawyer; born in Nassau, Germany, July 7, 1790; was educated at Heidelberg and Paris. His writings on the working of the Code Napoleon in the Germanic provinces of Switzerland were influential in jurisprudence; his dislike for the return of absolutism at home led to his emigration. He went to southern Illinois, where he spent his time educating his sons, one of them being Julius Erasmus Hilgard. He afterward returned to Germany, where he busied himself with sociological subjects, on which he wrote several treatises. He also translated Virgil and Ovid. He died in Heidelberg, Feb. 14, 1873.

HILL, AMBROSE POWELL, an American soldier; born in Culpeper County, Virginia, Nov. 9, 1825. He graduated at the United States Military Academy in 1847; served as lieutenant of artillery during the Mexican war, and was engaged in Florida against the Seminoles in 1849-50. When Virginia seceded, in 1861, Hill went with it, and was appointed colonel of the Thirteenth Regiment of Virginia volunteers. After the battle of Bull Run he was promoted brigadier-general, and fought as such in the battle of Williamsburg, in May, 1862, with such a spirit that he was made a major-general. After Jackson's death he became lieutenant-general, fought at Gettysburg, and in 1865 commanded the city of Petersburg during its siege. On April 2, of the same year, while reconnoitering, Hill was killed by a rifle-shot.

HILL, BENJAMIN HARVEY, an American statesman; born in Jasper County, Georgia, Sept. 14, 1823. He practiced law successfully in La Grange, Georgia, from 1845 to 1861. When his state seceded he was elected to the Confederate Senate at Richmond, where he remained till the close of the war. He was a Federal prisoner for several weeks, during 1865, and after his release earnestly opposed the reconstruction acts of Congress. In 1875 he was elected to Congress, but resigned on being chosen United States Senator in 1877. He died in Atlanta, Georgia, Aug. 19, 1882.

HILL, DANIEL HARVEY, an American general; born in York district, South Carolina, July 12, 1821. After graduating at West Point in 1842 he served through the Mexican War; resigned in 1849; was made professor of mathematics in Washington College, Virginia; and in 1859 president of the military institute at Charlotte. On the outbreak of the Civil War he became a Confederate colonel in the First North Carolina volunteers, and took part in the fight at Big Bethel, Virginia, in June, 1861. He then rose to the rank of major-general, and continued fighting till the surrender of Johnston's army. At the close of the war General Hill returned to Charlotte, North Carolina, where he published a monthly magazine, *Field and Farm*; and subsequently, *The Land We*

*Love*; also, *Elements of Algebra*; *The Crucifixion of Christ*; and *Consideration of the Sermon on the Mount*. He died at Charlotte, Sept. 24, 1889.

HILL, DAVID BENNETT, a United States Senator and lawyer; born in Havana, New York, Aug. 29, 1843. He received a

common-school and academic education; removed to Elmira, New York, and entered the profession of law. In politics he is a Democrat, and in 1865 was elected city attorney of Elmira; was elected a member of the state assembly in 1871 and 1872; afterward was elected mayor of Elmira. In 1882 was



DAVID B. HILL.

elected lieutenant-governor of the state of New York; became governor when Mr. Cleveland resigned to become President of the United States; was elected governor in 1885 and in 1887. In 1891 he was elected to the United States Senate to succeed William M. Evarts. He was nominated for governor in 1894, but was defeated at the polls; but still retained his seat in the Senate. He opposed the policy of President Cleveland, especially in relation to the tariff and income tax. At the Democratic convention of 1896 he refused to vote.

HILL, DAVID JAYNE, an American educator; born at Plainfield, New Jersey, June 10, 1850. He was educated at what is now Bucknell college, Pennsylvania, becoming professor of rhetoric there between 1877 and 1879, and from then till 1888 president of the same school. At that time he was called to the presidency of the University of Rochester. He published *The Science of Rhetoric* (1877); *Life of Washington Irving* (1879); *Principles and Fallacies of Socialism* (1885); *The Social Influence of Christianity* (1887); *Genetic Philosophy* (1893); besides many others; and writes for several magazines.

HILL, GEORGE WILLIAM, an American astronomer, born in New York City, March 3, 1838; after graduating from Rutgers College, 1859, he was appointed assistant in the office of *The Nautical Almanac*, which position he retained until 1892. He gave his attention almost entirely to mathematical theories of the celestial bodies; and in 1887 received the gold medal of the Royal Astronomical Society. In 1892 he published a work on the theory of Jupiter and Saturn.

HILL, JOHN HENRY, an American educator, born in New York City, Sept. 11, 1791; was educated at Columbia college; became a deacon in the Episcopal Church, and immediately, in 1830, started as a missionary to Greece. Through his efforts and those of his wife, a school for girls and later a school for boys was started, as well as a department for training teachers. Dr. Hill was chaplain of the British Legation for thirty years before his death; but continued his educational work, and the education and elevation of

women in Greece are due largely to his efforts and those of his wife. He died July 1, 1882, but his wife continued to manage the school for several years, and it is still in operation.

HILL, OCTAVIA, a British social reformer; born about 1838. She began work among the London poor under Frederick D. Maurice, but it was when acting as the almoner of John Ruskin that she performed her great work for those unfortunates. Going down into the slums, she purchased, in the east end of London, tenements which were filthy and dirty, which she put in sanitary condition and then rented to the inhabitants of these low quarters; looked after them herself and kept them on a paying basis, at the same time going among the occupants and striving to arouse in them habits of cleanliness, and feelings of self-respect. Her example had a good effect, and her strict sanitary regulations worked wonders. She never gave alms, but worked to make people help themselves, and was successful to a wonderful extent, reforming some of the most squalid families in London. Miss Hill wrote *Homes of the London Poor* (1875); *Our Common Land and Other Essays* (1878); together with other articles.

HILL, THOMAS, an American Unitarian clergyman and educator; born at New Brunswick, New Jersey, Jan. 7, 1818. He studied theology at Cambridge, and was ordained pastor at Waltham, Massachusetts, in 1845. From 1859 to 1868 he was successively president of Antioch College and of Harvard College. In 1868 he resigned on account of bad health. Then he became botanist of the Hassler expedition around the coast of South America under Professor Agassiz, in 1871. In 1872 he was pastor of a church at Portland, Maine, and remained till 1888. Hill published *Geometry and Faith* (1846); *Liberal Education* (1858); *Jesus the Interpreter of Nature* (1859); *Natural Sources of Theology* (1877); and some elementary mathematical books. He died in Waltham, Massachusetts, Nov. 21, 1891.

HILL, THOMAS, an American artist; born in Birmingham, England, Sept. 11, 1829; removed with his father to the United States when 11 years of age, settling first in Taunton, and afterward in Boston, in which latter city he was a carriage-painter, no one suspecting his talent until he began to paint little ornamental pictures in the omnibuses and stages which he was called upon to decorate. These called attention to him, and he was advised to study art. He went to Philadelphia in 1853, and entered the life class at the Academy; went to California in broken health in 1861, where he began work on portraits and figure pieces. One of the latter, the trial scene in *The Merchant of Venice*, won for him the first prize in the Art Union of San Francisco, in 1865. In 1866 he studied art in Paris for six months with Paul Meyerheim. Determined to follow landscape-painting, he returned to America, and opened a studio in Boston in 1867; but the climate was too severe for him and he returned to California, where he continued to

reside. It was his picture of *The Yosemite Valley* that introduced that scenic wonder to the world. Some of his noted works since that one are *The White Mountain Notch*; *Donner Lake*; *The Great Cañon of the Sierras*; *The Heart of the Sierras*; *The Driving of the Last Spike*; and *The Yellowstone Cañon*.

HILLARD, GEORGE STILLMAN, an American lawyer; born at Machias, Maine, Sept. 22, 1808; was graduated from Harvard College, 1828; admitted to the bar, 1833; was editor of the *Christian Register*, and assisted in editing the *Jurist*; state senator, 1850; and served in the Massachusetts constitutional convention, 1853, the labors of which, however, were rejected by the people. He was city solicitor, 1856, and then became part proprietor and editor of the *Boston Courier*, in which he opposed the efforts of the national government to restore its authority in the South. He published the lives of various men, among them General McClellan and John Smith; also wrote *Six Months in Italy*. He died Jan. 21, 1879.

HILL CITY, a village of Hamilton County, southeastern Tennessee, on the Tennessee River, opposite Chattanooga, of which it is a suburb. It is engaged in agriculture and mining. Population 1890, 1,763.

HILLER, FERDINAND, a German composer; born at Frankfort-on-the-Main, Oct. 24, 1811; was of Jewish parentage, and early developed his musical tastes. He studied under the best masters in Germany, Austria and France; returned to Frankfort in 1836, and took charge of the Cäcilienverein; for a few years was kapellmeister at Düsseldorf; and in 1850 accepted a like position at Cologne, where he resided during the rest of his life. He was director of concerts in all parts of Europe, and conducted the lower Rhine musical festivals from 1850. Besides publishing many compositions, he was a writer and teacher, having organized the conservatory at Cologne. Among his compositions are *Destruction of Jerusalem* (1839); *Traum der Christnacht* (1845); *Wala und Damayanti* (1871); and has written *Aus dem Tonleben unserer Zeit*; and *Briefe an eine Ungenannte*. He died at Cologne, May 12, 1885.

HILLERN, WILHELMINE BIRCH, a German novelist; born in Munich, March 11, 1836. She studied at Coburg, and later married the Kammerheer von Hillern, of Coburg, 1857. She wrote *Guten Abend* (1873); *Die Auge der Liebe* (1878); *Ein Arzt der Seele* (1869); *Die Geyer-Wally* (1873); *Die Friedhofsblume* (1883); and *Am Kreuz* (1890).

HILLIARD, HENRY WASHINGTON, American lawyer, statesman, and writer; born in Fayetteville, Cumberland Co., N.C., Aug. 4, 1808; was admitted to the bar at Athens, Ga., in 1829; and appointed professor in the State University of Alabama in 1831. In 1838 he was elected to the legislature as a Whig, and in 1842 President Tyler sent him as United States Minister to Belgium. From 1845 to 1851 he sat in Congress. At the outbreak of the civil war he went with the South, and held the nominal rank of brigadier-general in the

Confederate army. After the war he resumed the practice of law at Augusta, and afterward at Atlanta. From 1877 to 1880 he was United States Minister to Brazil. Hilliard published a volume of speeches in 1855. He died in Atlanta, Dec. 17, 1892.

**HILLSBORO**, a city and the capital of Montgomery County, southern central Illinois, 66 miles N.E. of St. Louis, Missouri, on the Cleveland, Cincinnati, Chicago and St. Louis railroad; on Shoal Creek. It exports agricultural produce, flour, furniture and woolen goods. Population 1900, 1,937.

**HILLSBORO**, a post village of northern Hillsboro, New Hampshire, situated in the Contoocook Valley. It contains woolen-mills, bedstead factory and shovel-handle shops. Population 1890, 2,120; 1900, 2,254.

**HILLSBORO**, a post village and the capital of Orange County, central northern North Carolina, 40 miles N.W. of Raleigh, on the Southern railroad, in a pretty, undulating region and a fertile, farming one. It has several tobacco factories and a military academy. Population 1900, 707.

**HILLSBORO**, a city and the capital of Highland County, southwestern Ohio 60 miles E. of Cincinnati, on the Baltimore and Ohio, and the Cincinnati, Portsmouth and Virginia railroad. It contains several educational institutions, banks, churches, scale and agricultural works, planing, flouring and woolen mills, foundries, bent-wood and furniture factories. It is the seat of Hillsboro College, a Methodist institution, founded in 1854. Population 1890, 3,620; 1900, 4,535.

**HILLSBORO**, a village and the capital of Washington County, northwestern Oregon, on the Tualatin River and the Southern Pacific railroad, 13 miles W. of Portland. It is situated in a farming and stock-raising section, with several blooded-stock farms near by. It has saw and flouring mills. Population 1900, 980.

**HILLSBORO**, a city and the capital of Hill County, eastern central Texas, on the Missouri, Kansas and Texas and the St. Louis Southwestern railroads, five miles S. of Fort Worth. The district produces grain, cotton and live-stock. It has a fine courthouse, costing one hundred thousand dollars; an academy, an artesian well water supply, and manufactures cotton-seed oil, ice, gin-feeders, and has a cotton compress. Population 1890, 2,541; 1900, 5,346.

**HILLSBORO RIVER**, the name of three streams in Florida. The first, sometimes called Mosquito River, is a salt-water lagoon in Volusia County, Florida, a continuation of Halifax River, extending 30 miles S. of Mosquito Inlet. It is separated from the ocean by a narrow strip of land, and was formerly called Mosquito South Lagoon. It is navigable for small boats, and is full of fish and oysters. The second rises in Polk County and flows southwest into Tampa Bay. Its length is about seventy miles. The third is a small stream, 15 miles long, in Dade County. Its course is nearly parallel with the coast, and it enters the ocean near lat. 26° N.

**HILLSDALE**, a city and the capital of Hillsdale County, central southern South Michigan, 25 miles S.W. of Jackson, on the Lake Shore and Michigan Southern railroad. It is the seat of Hillsdale College, a co-educational Free Baptist institution with 28 instructors and 521 students, founded in 1855, with a good library containing about 9,000 volumes. Its manufactories include screen-door, table and chair factories, machine-shops, foundries and flour-mills. It is provided with city water, gas and electricity and city mail service. Population 1900, 4,151.

**HILL STATES**, a number of small principalities of India on the east side of the Upper Sutlej, comprising about 10,000 square miles and about 550,000 inhabitants. With the exception of this aggregate name, they have but little in common with each other. There are about twenty distinct states.

**HILO**, an important seaport of Hawaii, situated on Byron Bay, an inlet on the east coast of the island, in lat. 19° 48' N., long. 155° 4' W. It is the second town in size in the Hawaiian Islands, and has a spacious and commodious harbor. Population, 4,231.

**HIMILCO**. See **CARTHAGE**, Vol. V, p. 160.

**HIMYARITIC OR SABÆAN LANGUAGE**. See **SEMITIC LANGUAGES**, Vol. XXI, p. 653.

**HINAYANA**, ancient school of Buddhism. See **LAMAISM**, Vol. XIV, p. 229.

**HINCKLEY**, a village of Pine County, central eastern Minnesota, on the Great Northern and the St. Paul and Duluth railroads, 72 miles N. of St. Paul. It was destroyed in September, 1894, by the devastating forest-fire of that region. Over 235 lives were lost in this one town. It was rebuilt, but is not growing. Population 1900, 459.

**HINCKS, SIR FRANCIS**, a Canadian statesman; born in Cork, Ireland, Dec. 14, 1807. He settled at Toronto in 1832, when he entered politics and edited the *Examiner*. After being elected to the Dominion Parliament, in 1841, he was appointed inspector-general. In 1851 he became Prime Minister of Canada, and held this post till 1854. The next year he was made governor of the Windward Islands, and in 1862 governor of British Guiana. After returning into Canada he assisted in uniting the British provinces to the Dominion of Canada. In 1869 Hincks was knighted. From that time till 1873 he was the finance minister of Canada. He founded the *Toronto Examiner* in 1838, and the *Montreal Pilot* in 1844, being editor of the first. For the last few years before his death he was editor-in-chief of the *Journal of Commerce* in Montreal. Died Aug. 18, 1885.

**HIND, JOHN RUSSELL**, an English astronomer; born at Nottingham, May 12, 1823. At an early period he became interested in the study of astronomy, and in 1840 obtained a situation in the Royal Observatory at Greenwich, where he remained till June, 1844. He was then sent as a member of the commission appointed to determine the exact longitude of Valentia, and on his return entered Bishop's Observatory, Regent's

Park, London. Here he calculated the orbits of more than seventy planets and comets, noted a number of new stars, and in 1847-54 discovered ten minor planets. In 1851 he obtained from the Academy of Sciences at Paris the Lalande medal, and was elected a corresponding member; in 1852 he received the gold medal of the Astronomical Society of London and a pension of £200 a year from the government. In 1853-92 he edited the *Nautical Almanac*; and in 1880 became president of the Royal Astronomical Society. His scientific papers were usually published in the *Transactions* of the Astronomical Society, in the *Comptes-Rendus* of Paris, and the *Astronomische Nachrichten* of Altona. He wrote *The Solar System* (1852); *Illustrated London Astronomy* (1853); *Treatise on Comets* (1857); etc. Died in Twickenham, Dec. 23, 1895.

HINDLIP, BARON. See ALLSOPP, SAMUEL, in these Supplements.

HINDMAN, THOMAS CARMICHAEL, a Confederate general, born in Tennessee in 1818. In the Mexican War he served as lieutenant of Mississippi volunteers. During 1859 and 1860 he was in Congress. On the outbreak of the Civil War he was made a brigadier-general in the Confederate army. He served first under Gen. S. B. Buckner in Kentucky, and commanded afterward at Memphis. He fought at the battle of Shiloh, was made a major-general and assigned to the chief command in Arkansas. At Chickamanga he commanded a division in General Polk's army. He was killed at Helena, Arkansas, by one of his former soldiers, Sept. 27, 1868.

HINDS, SAMUEL, a British clergyman; born in Barbadoes, 1793; graduated at Queen's College, Oxford, in 1815; became principal of Codrington College, Barbadoes, and in 1827, vice-principal of St. Alban's College, Oxford. He was successively chaplain to Archbishop Whately; vicar of Yardley; prebendary and rector of Castlenock, Dublin; chaplain to the Lord-Lieutenant of Ireland; dean of Carlisle, and bishop of Norwich, which office he resigned in 1857. He wrote a *History of Christianity* (1828); *The Three Temples of the One True God Contrasted* (1830); and *Scripture and the Authorized Version* (1845). He died in London, Feb. 7, 1872.

HINDUISM. See INDIA, Vol. XII, pp. 779-782; and BRAHMANISM, Vol. IV, pp. 201, et seq.

HINDU PHILOSOPHY. See SANSKRIT LITERATURE, Vol. XXI, p. 289.

HINGHAM, a manufacturing town of Plymouth County, eastern Massachusetts, on Hingham Harbor, 17 miles S.W. of Boston, on the New York, New Haven and Hartford railroad; has daily steamship connection with Boston. Fancy knit-goods, woodenware, cordage, bagging, furniture, boots and shoes, iron castings and worsted upholstery are made here. It is a popular summer resort. Population 1900, 5,059.

HINKSON, KATHARINE (TYNAN), an Irish authoress; born at Clondalkin, Ireland, in 1861; first known as a writer of verses and later as a novelist. Among her works are *Louise de la Val-*

*lière and Other Poems* (1885); *Shamrocks* (1887); *The Way of a Maid* (1895); *An Isle in the Water* (1896); *The Wind in the Trees* (poems, 1898); *The Handsome Brandons* (1898); and other tales, in which the writer displays much humor and insight.

HINSDALE, a village of Du Page County, north-eastern Illinois, on the Chicago, Burlington and Quincy railroad, 15 miles W. of Chicago. It has a classical academy. Population 1900, 2,578.

HINSDALE, a post village of Cheshire Co., N. H., on the Connecticut river and the Boston and Maine railroad; has good water-power, and manufactures woolen goods, lumber, and mowing-machines. Population 1890, 2,258; 1900, 1,933.

HINSDALE, BURKE AARON, an American educator and author; born at Wadsworth, Ohio, March 31, 1837. In 1861 he became a minister of the Christian (or Campbellite) Church; was pastor of a church at Solon in 1864, and afterward at Cleveland till 1868. Then he was made professor of history and English literature in Hiram College, and was its president from 1870 to 1882, when he became superintendent of public schools in Cleveland till 1886. In 1886 he was elected to the chair of pedagogy in the University of Michigan. He published *Authenticity of the Gospels; Evolution of the Theological Systems of the Ancient Church; Life and Works of President Garfield; Schools and Studies; The Old North West; American Government* (1891); *Studies in Education* (1895); *History and Civil Government of Ohio* (1896); *Teaching the Language Arts* (1896); articles on EDUCATION and SCHOOLS in these Supplements.

HINTON, a town and the capital of Summers County, southern West Virginia, on the New River, where it receives the Greenbrier; on the Chesapeake and Ohio railroad, at the foot of the White Oak Mountains, amidst beautiful scenery. The railroad has repair-shops here, and there are here also large steam saw-mills, a valuable brownstone quarry and coal-mines. Population 1880, 879; 1890, 2,570.

HIODONTIDÆ (derived from the shape of the hyoid bone), an order of isospondylous, teleocephalous, herring-like fishes, with cycloid scales and naked head, a peculiar structure of supra and intermaxillaries, and dorsal fin situated in the posterior portion of the body. The eggs are first injected into the abdominal cavity. The "moon-eye" herring (*Hiodon tergesius*), proper to the family, finds its habitat in western lakes and rivers.

HIP, in botany, a name often applied to the fruiting condition of the peculiar concave receptacle found in many of the *Rosaceæ*, notably in the genus *Rosa* itself, where the hip, commonly known as the fruit, ripens into a more or less pulpy and bright-colored body. Certain rose-hips are used in pharmacy and in confections, and some are used as food by wild animals.

HIP-JOINT DISEASE, technically known as *Coxalgia*, *Coxitis*, *Tubercular Arthritis*, etc., an inflammation of the hip-joint and adjacent tissues. It is a disease of childhood, occurring rarely after the twelfth year, the majority of cases being

between one and six years of age; but adults are not infrequently the subjects of attack.

The predisposing causes are such as weaken the general tone of health; as, a disturbance of nutrition; and the scrofulous constitution. In persons thus predisposed a slight injury to the joint, a fall or a blow, a distortion, a wrench or over-exertion may be followed by inflammation of the joint. But the real cause is believed to be the presence in the body of exceedingly minute organisms called *tubercle bacilli*. These bacilli exist in the air, in food and water, and find their way into the blood through the lungs, stomach, a puncture or other form of wound.

The symptoms are at first pain, either in the hip or the knee of the affected side, greater at night or in the early morning; the person rests on the ball of his foot, and in walking limps, or drags the leg, stiffly extending it. In time the person lies with the thigh flexed on the abdomen, the body bends forward in walking, the leg is shortened.

The disease may originate either in the synovial membrane which lines the cavity of the joint or in the head of the thigh-bone. Bacilli finding their way to the synovial membrane induce in it an inflammation. Tubercular nodules, spongy fungous forms, granulations and fibrous growths cover the surface of the membrane. Its blood-vessels are congested and weakened, and blood may escape into the joint-cavity. The fluid of the joint (synovial) is increased in quantity, often so much as to distend the capsule or covering of the joint and force the fluid into surrounding tissues. If the inflammation continues the capsule becomes thickened and the joint-cavity is filled with diseased products. The tubercular growths push their way over the cartilages and ligament into the bone of the socket and into the head of the thigh-bone, which are softened and disorganized; in short, wherever tubercular tissue develops the original tissue is destroyed. The whole joint and adjacent parts, by this destructive process, may form an abscess which may work its way outward through the skin. If the bacilli first find lodgment in the thigh-bone they work their way upward into the joint, with results as above described. In the last stage of the disease the head of the thigh-bone separates from its shaft, adheres to the socket and the leg is shortened. The patient's strength is undermined, hectic fever sets in, emaciation becomes extreme, and death occurs from exhaustion or from general tubercular infection, often from tuberculosis of the lungs.

The prospects for complete recovery are not favorable. Partial or complete stiffness of the joint, with more or less shortening of the limb, will, in most cases, be the result, however well treated. At least 12 per cent of all cases beginning with inflammation of the thigh-bone terminate fatally in from one to six years. Good and timely treatment in the first stage cures 50 per cent; surgical treatment in the last stage cures one half the cases treated. The treatment of

this disease, until within a few years, was largely surgical, and often of the most heroic kind. But at present (1896) it is of a more conservative character. Instead of operative treatment there is now chemical treatment, chiefly by the injection of antiseptic fluids into the diseased parts to destroy the bacilli. Much attention is given to nourishing food and pure air, to baths, and to tonics in general which strengthen life. Dr. Koch, a German physician, who discovered the tubercle bacilli, has prepared a remedy which he calls "tuberculin," and which has been used in the treatment of the various forms of tuberculosis. Its curative principle is an excretion from the bodies of the bacilli themselves, which it destroys. It is injected into the blood, through which it reaches the diseased tissues. But the results from its use have not as yet been uniformly successful or satisfactory, and it is now rarely employed. It is believed, however, that a similar remedy, and one to be found along similar lines of investigation, will yet be discovered. See *Diseases of Joints*, under SURGERY, Vol. XXII, pp. 685, 686.

HIPPEAU, CELESTIN, a French author and educationist; born at Niort, Deux-Sèvres, May 11, 1803. His earlier studies were pursued in his native city, and he subsequently held positions as professor at Poitiers, Napoléon, Vendée, Strasbourg, Paris and Caen. He received the decoration of the Legion of Honor in 1861. Among the most prominent of his writings are *Histoire de l'Abbaye de Saint-Etienne de Caen, 1006-1790* (1855); *Histoire du Gouvernement de la Normandie* (1863-73); and *Avènement des Bourbons au Trône d'Espagne* (1875). He died in Paris, May 31, 1883.

HIPPIAS, tyrant. See GREECE, Vol. XI, pp. 97-99.

HIPPIAS OF ELIS. See SOPHISTS, Vol. XXII, p. 265.

HIPPOCRAS (*vinum Hippocraticum*, "wine of Hippocrates"), an aromatic medicated wine, formerly much used as a cordial. It was prepared from white wine, flavored with cinnamon and other spices, lemon peel, almonds, etc., and sweetened with honey or sugar.

HIPPOCRENE. See PEGASUS, Vol. XVIII, p. 468.

HIPPODAMIA. See PELOPS, Vol. XVIII, p. 480.

HIPPODROME. See OLYMPIA, Vol. XVII, p. 768.

HIPPOGRIFF OR HIPPOGRYPH (Gr. *hippos*, "a horse," and *gryph*, "griffin"), a fabulous animal, unknown to the ancients, which is represented by modern writers as a winged horse with the head of a griffin. The hippogriff figures as the horse of the Muses, and plays a conspicuous rôle in the *Orlando Furioso* of Ariosto.

HIPPOLYTUS LEGEND. See THESEUS, Vol. XXIII, p. 294.

HIPPOPHAGY, HIPPOPHAGI (Gr., "eaters of horse-flesh"), was a name given by the Greeks to a Scythian people living northeast of the Caspian Sea, and to a Sarmatian tribe north of the

Euxine, who ate horse-flesh. In some parts of Europe horse-flesh is a regular and wholesome article of diet. In 1866 the sale of horse-flesh in the Paris markets as an article of food was recognized and regulated officially; and during the siege of Paris, horse-flesh was gladly eaten by all who could get it. In Great Britain an act was passed in 1889, regulating the sale of horse-flesh, requiring that all horse-flesh exposed for sale should be expressly so described. In the United States no general law has been enacted, but the use of horse-flesh for food is prevented in the larger cities by a high-license system. From experiments, horse-flesh has been found to contain more nutriment than beef, and people who eat it claim it is better than beef of the same age.

**HIPURIC ACID**,  $C^9H^9NO^3$ , a compound of great interest to chemist and physiologist. It derives its name from its having first been discovered in the urine of the horse, and that fluid, or the renal secretions of the cow, affords the best and readiest means of obtaining it. The crystals of hippuric acid are moderately large, colorless, but subsequently becoming milk-white, four-sided prisms, which are devoid of odor, but have a faintly bitter taste. They dissolve readily in boiling water and in spirit. It is an abundant normal constituent of the urine of the horse, cow, sheep, etc., and probably is to be found in the urine of all vegetable feeders. In the urine of healthy persons living on an ordinary mixed diet it occurs in very small quantity, but it is increased by an exclusively vegetable diet and in the well-known disease, diabetes. The hippuric acid occurring in the animal organism exists in combination with bases, and chiefly as hippurate of soda and hippurate of lime. The last-named salt can be obtained by the mere evaporation of the urine of the horse. Hippuric acid readily splits into benzoic acid and glycocholl. If benzoic acid is administered it is excreted as hippuric acid, combining with glycocholl in the body. In herbivorous animals the benzoic acid is largely derived from the food; in animal feeders, even in starvation, it occurs in small amount in the urine; and, therefore, it is concluded that its forerunners may be derived from the metabolism of the tissues. That certain bodies closely allied to benzoic acid may so be formed, has now been demonstrated experimentally, while glycocholl can also be proved to be produced in that manner. At one time the belief was entertained that these bodies were combined in the liver; but more recent search has shown that the synthesis chiefly takes place in the kidneys.

**HIPPURITES**, a genus of bivalve mollusks found in the cretaceous formations of Europe and America. The Hippurite limestone of Europe is composed largely of their shells. These mollusks are so unlike ordinary bivalves that they have been classed as barnacles, worms or corals by some authors. The valves of the shell are very unequal, and the animal is attached to foreign objects by one valve. One valve is greatly elongated into a tubular or cone-like

structure. *Hippurites* is the typical genus of a family of cretaceous mollusks which Lamarck named *Sudistes*, but recent authors adopt the term *Hippuritide*.

**HIRAM**, a town of Portage County, north-eastern Ohio, 11 miles northwest of Ravenna, on the New York, Lake Erie and Western Railroad. It is the seat of Hiram College, an institution founded by the Church of the Disciples of Christ in 1850. The college has 18 instructors, 400 students, and a library of 5,000 volumes. Population 1900, 659.

**HIRAM**, King of Tyre. See PHENICIA, Vol. XVIII, p. 807.

**HIRE**, LAURENT DE LA, a French classical painter; born in Paris in 1606. He was a student under Vouet, but endeavored to form a style of his own. His easel pictures and landscapes were prized highly, while some of his larger works are to be seen in the Carmelite and Capuchin churches in Paris. He was one of the first members of the Academy of Painting and Sculpture, founded in 1648, and now known as the Academy of Fine Arts. He died in Paris, 1656.

**HIRN**, GUSTAVE ADOLPHE, a French physicist and engineer; born at Logelbach, near Colmar, Alsace, Aug. 21, 1815. He entered the cotton-mill of his grandfather, and there made his first investigations. As a result of his systematic study of the steam-engine, he revealed to the engineering world the extent of the wastes of the modern engine. In 1845 he published his first essay, *On the Mathematical Theory of Fan-blowers*, and later followed this with others of a scientific nature, besides numerous contributions to the *Bulletin de la Société Industrielle de Mulhouse*. He was elected secretary of the Academy of Sciences in 1867. He died March 12, 1890, at Logelbach.

**HIROSHIMA**, a city of Japan, in the department of Aki; situated on the Inland Sea. Opposite Hiroshima lies the island of Miyajima or Itskushima, "island of light." This island is one of the San-Kei or three chief sights of Japan. The great temple of Bentin, being partly built over the sea on piles, has the appearance at high tide of floating on the surface of the water. The Royal Naval College, removed from Tokyo in 1890, is situated on an island of Hiroshima. Population 1896, 107,685.

**HIRSCH**, EMIL G., an American Jewish rabbi; born in the Grand Duchy of Luxemburg, May 22, 1852; emigrated to the United States in 1866; educated in America and Germany, being a graduate of the universities of Pennsylvania, Berlin and Leipsic. He has held the position of rabbi in the cities of Baltimore, Maryland; Louisville, Kentucky; and Chicago, Illinois; a professor of Semitic languages in the University of Chicago; director of the Chicago Public Library, having been twice president of the Board of Directors; president of the Board of Examiners of the Civil Service Commission. Dr. Hirsch has published a volume of sermons, and *Truths of Fiction from a Jewish Point of View*. He contributed the article



ON JUDAISM AND JEWS IN THE UNITED STATES, in these Supplements.

HIRSCH, JOSEPH, a French civil engineer; born at Lyons, France, May 22, 1836; graduated at the École des Ponts et Chaussées, 1857; constructed a portion of the Canal de l'Est; director of the metallurgical works of Ars-sur-Moselle; invented the Mittersheim siphon. He was appointed professor on steam-engines at the École des Ponts et Chaussées and at the Conservatoire des Arts et Métiers. He published a number of valuable scientific works, including a translation of Thurston's *On the Steam-engine*.

HIRSCH DE GEREUTH, BARON MAURICE DE, Austrian financier and philanthropist; born in



BARON MAURICE DE HIRSCH.

Munich, Bavaria, Dec. 9, 1833; died at O'Gyalla, near Komorn, Hungary, April 20, 1896, leaving an estate estimated at \$200,000,000; married the daughter of a wealthy Belgium senator, whose dowry, added to his own inheritance, enabled him early in life to undertake financial schemes resulting in a princely fortune. In 1888 the loss of

a beloved son at the age of 20 moved the baron to devote \$20,000,000, accumulated by the youth's financial ability aided by his father's prevision, wholly to charities. By the advice of prominent Jews of all countries, the investment of this vast sum was made in behalf of indigent Jews in Hungary, Russia, Galicia, and Roumania, among which countries the amount was equally divided. Even in Russia and Roumania, where the experiment proved unsuccessful, owing to Russian opposition, the accrued interest from the son's imaginary bequest has been regularly distributed for charitable purposes, the baron having regarded himself merely as a faithful executor. Then came the heartless decrees of expulsion of Jews from the Russian Empire, which inspired Baron Hirsch with intense sympathy for the fate of his co-religionists. He devised a colossal scheme of emigration, guaranteeing an expenditure of \$10,000,000, with the object of assisting the expatriated Jews, embracing colonial settlements in other countries—chiefly in the Argentine Republic, where nearly half a million acres were acquired, at a cost of more than \$1,000,000. The Russian government tardily acquiesced in the project, which proved an eminent success, in 1895 the establishment of 1,222 families being reported, the earlier colonists rapidly becoming independent of provisional subsidies. The refusal of the Tsar to accept \$10,000,000 for popular education on condition that his Jewish subjects should share in the advantages is a significant commentary on the baron's munificence and the recalcitrant attitude of the Russian government.

The above benefactions but partially cover the enormous sums dispensed in Baron Hirsch's charitable work. In 1891 alone he expended \$15,000,-

000 in philanthropic service. He was an enthusiastic turfman, and won large sums from successful ventures in horse-racing; yet his entire winnings were devoted to the London hospitals, not even his personal expenses being withheld. To the Alliance Israélite, of Paris, he contributed nearly \$500,000. Not less interesting among his beneficent enterprises was the establishment of a Jewish settlement at Woodbine, N. J., in 1891, now a thriving community of 700 Russian exiles, each family being supplied with thirty acres of land and necessary farming implements. His total gifts amounted to \$50,000,000; and those of his widow were proportionately munificent. She died in Paris, April 1, 1899.

HIRSCH FUND, THE, was created by Baron Hirsch for the benefit of needy Hebrew immigrants from Russia and Roumania in the United States. The fund, amounting to \$2,400,000, was conveyed in February, 1891, to a board of trustees in New York City, to be invested in the United States, and the net income (estimated to be \$10,000 a month) to be loaned to Hebrew immigrants. The specific purpose of the fund is to furnish mechanics with tools, teach easy trades, aid in securing employment, and in exceptional cases to be loaned out to immigrants until they become self-supporting. At present a flourishing colony is in existence at Woodbine, New Jersey. Similar colonies are being projected in Minnesota, Pennsylvania, Texas and New Mexico. In addition, classes are conducted in manual training in connection with the Hebrew Technical Institute of New York, and a school for young and old immigrants is established, while transportation is furnished those leaving the seaboard cities for the interior.

HIRST, THOMAS ARCHER, an English mathematician and scientist; born at Heckmondwike, Yorkshire, April 22, 1830; studied under Bunsen and others at the University of Marburg, and obtained the degree of doctor of philosophy. He became a friend of Tyndall, and in company with him made a study of the glaciers of Switzerland. His experiences are described in *Glaciers of the Alps*. He was made a fellow of the Royal Society in 1861, and in 1873 director of studies of the Royal Naval College. He wrote a large number of original papers on mathematics and physics, published in the proceedings of various societies. Among these writings are *On the Correlation of Two Planes* (1875-77); *On Congruences of the Third Order and Class* (1885); and *Cremonian Congruences which are Contained in a Linear Complex* (1887).

HIS, WILHELM, a Swiss anatomist; born at Basel, July 9, 1831; educated at the Universities of Berlin, Würzburg, Prague, Vienna and Paris; professor of anatomy and physiology at Basel; and, since 1872, professor of anatomy at Leipsic. He published several valuable works on anatomy and embryology, among them *Crania Helvetica* (1864), and *Recherches sur la Formation Primitive du Corps des Vertébrés* (1868).

HISSARLIK. See TROAD, Vol. XXIII, p. 581.

HISTILÆA. See EUBŒA, Vol. VIII, p. 648.

HISTILÆUS. See PERSIA, Vol. XVIII, p. 570.

HISTORICAL AND GENEALOGICAL SOCIETIES IN AMERICA. Following the interest awakened in GENEALOGIES (q. v., in these Supplements) considerable activity has been shown in the United States in the formation of historical and genealogical societies. These, with naturally a wider scope than that of the man delving into the history of a single family, have as a rule issued at stated intervals valuable reports of their proceedings, which, in themselves, constitute the most valuable material for the local historian. At times the organization has been enlarged in its operations to a county or state, rather than confined to a single township or a distinct locality.

The pioneer society—The New England Historical and Genealogical Society—bravely covered the New England field, and from 1847 regularly issued its invaluable and well-indexed *Register*. A work such as this last has become a *sine qua non* to the historian of the future, whether he deals with state, county or town. Massachusetts holds high rank in the matter of such societies, no fewer than eighty-nine being described in Senator Roe's *Massachusetts Year Book*.

New York, Rhode Island, Pennsylvania and many other states have long boasted of excellent societies doing meritorious work. It is in the exhumation and publication of local and long-forgotten records dealing with important eras of national and local history that these societies have been in the past, and will be in the future, of inestimable value to the community. Often a society has rendered valuable assistance in the publication of local histories. A list of the more important of such works may be found in Durrie's *Index to American Genealogies*; Marshall's *Genealogist's Guide* (as to England, mainly); and in *The Bulletin of the Boston Public Library* (October, 1891).

HITCHCOCK, CHARLES HENRY, an American geologist; born at Amherst, Massachusetts, Aug. 23, 1836; was graduated from Amherst College. He studied divinity at New Haven and science at the Royal School of Mines, London. He was professor of geology at Lafayette College from 1866 to 1870, and, after the latter year, professor of the same science at Dartmouth College. He published many scientific papers, and several volumes of reports prepared in connection with various state geological surveys, most important among which is the *Final Report on the Geology of New Hampshire* (1874-78).

HITCHCOCK, EDWARD, an American specialist in physical culture; born at Amherst, Massachusetts, May 23, 1828; was graduated from Amherst College in 1849, and attended Harvard Medical School in 1852. In 1861 he was appointed professor of hygiene and physical education in Amherst College. The chair of physical culture at Amherst was the first of the kind established in this country. He was for many years a member of the state board of health of Massa-

chusetts, and a director of Mount Holyoke College and of Clark Institute for the Blind. Author of *Anatomy and Physiology* (1852).

HITCHCOCK, ETHAN ALLEN, an American general and author; born at Vergennes, Vermont, May 18, 1798. After graduating at West Point in 1817, he was assistant instructor in tactics there until 1829, and from that time till 1833 he was commandant of cadets. In the Mexican War he was inspector-general under Scott. Becoming colonel in 1851, he was placed in command on the Pacific coast. When the Civil War broke out he was appointed major-general of volunteers in the Union army in February, 1862, and soon afterward made commissary-general of prisoners. He retired from service in October, 1867, and died at Sparta, Georgia, Aug. 5, 1870.

HITCHCOCK, ROSWELL DWIGHT, an American theologian and educator; born at East Machias, Maine, Aug. 15, 1817. Graduated at Amherst College in 1836, and after some years spent in teaching and in attendance at Andover Theological Seminary, he was in 1845 ordained pastor of the First Congregational Church of Exeter.

He later spent a year in Germany at the Universities of Halle and Berlin; resigned his pastorate in 1852 to accept the Collins professorship of natural and revealed religion in Bowdoin College; and three years later was called to the Washburn professorship of church history in Union Theological Seminary, New York City. He spent some time in travels through Greece, Italy and Palestine, and in 1871 was elected president of the American Palestine Exploration Society. In 1880 he was appointed president of Union Theological Seminary.

He received the degree of D.D. from Bowdoin in 1855 and from the University of Edinburgh in 1885, and of LL.D. from Williams in 1873 and from Harvard in 1886. He was a trustee of Amherst from 1869 until his death. From 1863 to 1870 he was one of the editors of the *American Theological Review*.

Besides numerous articles, essays, orations and addresses on religious topics, he also wrote and published a number of church hymns. Among his writings are *Life of Edward Robinson* (1863); *Hymns and Songs for Social and Sabbath Worship* (1875); and *Socialism* (1879). Died at Somerset, Massachusetts, June 16, 1887.

HUEN-TSANG. See HWEN T'SANG, Vol. XII, p. 418.

HIVES. See NETTLE-RASH, Vol. XVII, p. 360; and SKIN DISEASES, Vol. XXII, p. 122.

HIWASSEE COLLEGE, an institution established by the Methodist Episcopal denomination in Monroe County, Tennessee, in 1849. The college had, in 1895, 4 instructors, 70 students, and a library of 2,200 volumes. The institution became co-educational in 1894.

HOADLEY, BENJAMIN, JR., an English physician and author; born in London, Feb. 10, 1706; studied at Cambridge, and received the degree of doctor of medicine in 1728; was appointed physician to the royal household in 1742. He

wrote a successful comedy, *The Suspicious Husband*, and assisted Hogarth in his *Analysis of Beauty*. In 1756 *Observations on a Series of Electrical Experiments* was published by him. He died at Chelsea, Aug. 10, 1757.

HOANG-HO OR HWANG-HO. See *Yellow River*, under CHINA, Vol. V, pp. 630, 631.

HOAR, EBENEZER ROCKWOOD, an American jurist, son of Samuel Hoar, mentioned below; born at Concord, Massachusetts, Feb. 21, 1816. His mother was a daughter of Roger Sherman. He was admitted to the bar in 1840. In 1849 he became judge of the court of common pleas, but resigned in 1855. Soon afterward he was appointed a justice of the supreme court of Massachusetts, and held this office until 1869, when President Grant appointed him Attorney-General of the United States. He was one of the joint high commission on the Washington treaty of 1871, and a member of Congress from 1873 to 1875. He died at Concord, Jan. 31, 1895.

HOAR, GEORGE FRISBIE, an American jurist and statesman, brother of the preceding; born at Concord, Massachusetts, Aug. 29, 1826; studied at Harvard; and was admitted to the bar of Massachusetts in 1849. He was elected a member of the lower house of Congress from Massachusetts in 1869, and to each subsequent House of Representatives till 1877, when he took his seat as a Republican in the United States Senate, to which



GEORGE F. HOAR.

he was re-elected in 1883, 1889 and 1895. He presided over the Republican National Convention of 1880.

HOAR, SAMUEL, an American statesman, born at Lincoln, Massachusetts, in 1778. Being admitted to the bar in 1805, he soon became eminent in his profession. He was a member of Congress in '835-37, and a state councilor in 1845-46. The state of Massachusetts sent him to South Carolina in 1844 to test the constitutionality of acts of the latter state by which free negro sailors were seized and imprisoned on entering its ports. But on December 5th of the same year he was driven from Charleston by a mob, and the South Carolina Legislature authorized the governor on the same day to expel him from the state. He died at Concord, Massachusetts, Nov. 2, 1856.

HOBART, Tasmania. See HOBART-TOWN, Vol. XII, p. 29.

HOBART, GARRET AUGUSTUS, an American statesman, born at Long Branch, New Jersey, in 1844. He graduated from Rutgers College and studied law in the office of one of New Jersey's most distinguished lawyers, Socrates Tuttle, whose daughter he afterward married. After completing his law studies he began the practice of his profession in Paterson, New Jersey, which he made his permanent residence, and in

addition to his legal occupation engaged in various enterprises, becoming president of several local corporations in the nature of water companies, gas companies, street and suburban railways. He also acquired interests in various manufactories and railroads. He early identified himself with the politics of his state, and served in both branches of the legislature, both as speaker of the house and president of the state senate.

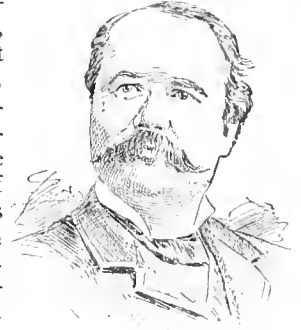

GARRET A. HOBART.

In 1884 he became both state and national committeeman, holding these positions until Nov., 1896, when he was elected Vice-President of the United States, on the regular Republican ticket. Died at Paterson, N. J., Nov. 21, 1899.

HOBART, JOHN HENRY, an American Protestant Episcopal bishop and author; born in Philadelphia, Sept. 14, 1775; was graduated in 1793 from Princeton College, where he was afterward tutor until admitted to holy orders in 1798. He was successively pastor at New Brunswick, Hempstead, and Trinity Church, New York City, and in 1816 was chosen bishop of New York. He was active in founding the General Theological Seminary in New York City, in which he became professor of pastoral theology in 1821. He visited Europe in 1824, and in England published sermons on the *Redemption*. By his writings and his personal influence, Bishop Hobart must be considered one of the leaders of theological thought in the United States. Among his published works are *Companion for the Altar*; *Apology for Apostolic Order*; and two volumes of sermons. He died at Auburn, New York, Sept. 12, 1830.

HOBART COLLEGE, an institution at Geneva, New York, under the control of the Protestant Episcopal Church. The school, projected in 1812, founded for academic work in 1822, was chartered as Geneva College in 1825; the name was changed to Hobart Free College in 1852, and in 1860 it became Hobart College. There are three courses, leading respectively to the degrees A. B., B. S., and B. L. The college is not open to women. There were in the college in 1896, 17 instructors and 81 students, with alumni numbering over thirteen hundred. The equipment includes numerous scholarships, a chemical and physical laboratory, a cabinet and museum, a gymnasium and a library of 30,000 volumes.

HOBART PASHA, AUGUSTUS CHARLES HOBART-HAMPDEN, an Anglo-Turkish naval officer, third son of the Earl of Buckingham; born at Waltham-on-the-Wolds, Leicestershire, April 1, 1822; entered the British navy in 1836, retiring from active service in 1860. During the Civil War in the United States he became distinguished as a successful blockade-runner, under the name of Captain Roberts, skillfully eluding pursuit, and

rendering material assistance to the Confederate cause. He afterward entered the Turkish service, being appointed to the chief command of the Turkish fleet in the war against Russia. He was the first naval officer to maintain the possibility of perfect immunity from torpedoes by the adoption of suitable precautions, such as ample nettings, etc. His assumption of the chief command in the Turkish naval service brought him into conflict with the home authorities, and led to the erasure of his name from the British navy-list. In 1885, however, he was reinstated, with the rank of vice-admiral. He published several works full of stirring adventure, among them *Twelve Successful Trips in Blockade-Running* (1867); *The Torpedo Scare* (1885); and *Sketches from My Life* (1886). Died in Milan, Italy, June 19, 1886.

HOBBES, JOHN OLIVER. See CRAIGIE, MRS. MARY E., in these Supplements.

HOBBY. See FALCON, Vol. IX, p. 3.

HOBOKEN, a city and port of entry of Hudson County, New Jersey, on the west bank of the Hudson river, opposite New York city, and immediately above Jersey City. It has an extensive trade in coal, being one of the principal depots from which New York and its shipping are supplied; and four lines of European steamships (the Netherlands-American, the Hamburg-American, the North German Lloyd, and the Thingvalla) start from this port. The principal industries of the place are the manufacture of lead pencils, caskets, leather goods, foundry and machine-shop products. It is connected with Jersey City by electric railways; and is lighted with electricity. It has a public library, two convents, a monastery of the Passionate Fathers, St. Mary's Hospital and Stevens Institute of Technology. Population 1880, 30,999; 1890, 43,648; 1900, 59,364. See Vol. XII, p. 40.

HOBOKEN DOCKS FIRE. On June 30th, 1900, a terrible fire, resulting in a calamitous loss of life, broke out in the docks at Hoboken, N. J., of the North German Lloyd Steamship Co. The fire had its origin in some cotton bales, and everything being dry with the excessive heat then prevailing, it speedily destroyed three piers belonging to the company, together with three great liners, the "Saale," the "Main," and the "Bremen." The "Kaiser Wilhelm der Grosse" was saved with difficulty, her bow having caught fire before she was removed. About 1,000 persons, many of them women and children, were on board the ill-fated vessels, between two and three hundred of whom, including stokers and seamen, were burned or drowned.

HOCHHEIM, a town of southeastern Prussia, in Hesse-Nassau, on the right bank of the Main, 3 miles E. of Mainz. Here is produced the white wine known as *Hochheimer*.

HÖCHST, a town of Hessen-Nassau, southwestern Prussia, on the north bank of the Main, five miles W. of Frankfurt. Here, in June 20, 1622, Tilly defeated Duke Christian of Brunswick, and on Oct. 11, 1795, the Austrians defeated the French under Jourdan. It has manufactories of furniture and to-

bacco. Population 1890, 8,455. See AUSTRIA, Vol. III, p. 130.

HOCKING OR HOCKHOCKING RIVER, a river in Ohio, having its rise in Fairfield County, and flowing southeast for 80 miles until it joins the Ohio River. It is navigable for a distance of 70 miles.

HODGE, CHARLES, an American theologian; born in Philadelphia, Dec. 28, 1797; graduated at Princeton College in 1815; in 1822 appointed professor in the Princeton Theological Seminary, where he remained till the close of his life. He was founder and long the editor of the *Princeton Review*; and besides numerous essays, etc., he was the author of commentaries on Romans, Corinthians and Ephesians, of a history of the Presbyterian Church in America (1840), and of the well-known *Systematic Theology*, now a standard work of the Calvinistic churches. He died June 19, 1878, at Princeton, New Jersey.

HODGE, FREDERICK WEBB, an American ethnologist; born at Plymouth, England, Oct. 28, 1864; was taken to the United States when seven years of age; he was educated at Washington, District of Columbia, and in 1884 received appointment to the United States Geological Survey. In 1886 he resigned his position in the Geological Survey, and became secretary of the Southwestern archaeological expedition. Detailed surveys and maps on a large scale of the ruins of Los Muertos, with their accompanying irrigation *acequias* and reservoirs, descriptions of which have been embodied in papers on the *Architecture of the Prehistoric Pueblos of Southern Arizona* and *Methods of Irrigation of the Ancient Inhabitants of the Salado Valley*. In 1889 Mr. Hodge was appointed to the bureau of ethnology, Smithsonian Institution.

HODGE, HUGH LENOX, an American surgeon; born in Philadelphia, June 27, 1796; graduated from Princeton; took medical degree from the University of Pennsylvania, and was for many years professor of obstetrics in the latter institution. He wrote a standard treatise on *Diseases Peculiar to Women* (1868), and was the author of a *System of Obstetrics* (1864). He died in Philadelphia, Feb. 23, 1873.

HODGKINSON, EATON, an English engineer; born at Anderton, near Northwich, Cheshire, Feb. 26, 1789. He devoted his life to a study of the strength of iron rails, pillars, etc. He discovered that an iron rail in the shape of an inverted letter T will support a greater pressure than any other. His formulæ for solid and hollow iron pillars are generally accepted. Hodgkinson was associated with George Stephenson in the construction of the tubular Britannia bridge in 1845. He died near Manchester, June 18, 1861.

HODGSON, JOHN EVAN, an English painter; born in London, March 1, 1831. Spent his early years in Russia; returned to England in 1853; entered the Royal Academy in 1855, and exhibited his first picture the following year. He went to Tunis and Tangiers in 1868, and after his return exhibited many pictures of Eastern life. Among his noted works are *The First Sight of the Armada*

and *An Arab Story-Teller*. He died June 19, 1895.

HODSON, WILLIAM STEPHENS RAIKES, a noted English soldier; was born at Maise more Court, near Gloucester, March 19, 1821. Choosing a military career, he joined the Indian army in 1845. From 1849 to 1852 he was employed in the work of civil government in the Punjab. Then being made commandant of the Guides Corps, he did excellent service on the turbulent frontier. But in 1856 he was deprived of his command on account of irregularities in the regimental accounts and of his unjust treatment of the troops and natives under his authority. In the crisis of the mutiny, however, he was appointed head of the intelligence department in the army engaged before Delhi, and was commissioned to raise a new regiment of irregular cavalry, which became known as "Hodson's Horse." With this body of men Hodson took part in the siege of Delhi and in the subsequent operations down to the siege of Lucknow. After the siege of Delhi, Hodson pursued the King, who had taken to flight, and captured two of the princes. An attempt was made on the road to Delhi to rescue the princes, whereupon Hodson shot them both with carbines, which he had seized from his soldiers. He himself was shot on March 11, 1858, during the assault on a royal palace in Lucknow, and died the following day.

HOE, RICHARD MARCH, an American inventor; born in New York City, Sept. 12, 1812; was the son of an English printer, who came to this country in 1803, and who invented the printing-press known by his name. The son improved upon the invention of the father, and to his efforts are due many notable improvements which the power-press has received. In 1846 he brought out "Hoe's Lightning Press," used very widely for newspaper-work. He died in Florence, Italy, June 7, 1886.

HOEFER, JOHANN CHRISTIAN FERDINAND, a German scientist and author; born at Doerschnitz, in the principality of Schwarzburg-Rudolstadt, April 21, 1811; became, in 1834, secretary to Victor Cousin, whom he assisted in the translation of the works of Plato; he took up the study of medicine, and in 1843 was sent by Cousin to Germany to study the methods of medical instruction and practice in that country. In 1842 he published the *History of Chemistry from the Earliest Times to the Present*. In 1851 he was selected by the Messieurs Didot to edit their great biographical dictionary, *Nouvelle Biographie Générale*, for which he wrote able articles on Aristotle, Cæsar, Columbus, Descartes, Erasmus and others. He died at Brunoy in May, 1878.

HOEY, FRANCES SARAH (JOHNSTON), an Irish authoress; born at Bushy Park, near Dublin, Feb. 15, 1830. She married A. M. Stewart in 1846, and in 1858 John Cashel Hoey. After 1860 she contributed largely to magazines, and published a large number of novels; also translations of French and Italian works. Among her novels are *A House of Cards* (1868); *The Blossoming of an Aloc* (1874); *Griffith's Double* (1876); *The Question of Cain* (1882); *The Lover's Creed* (1884); *A Stern Chase* (1886); *The Queen's Token*; *His Match and More*; and *Buried in*

*the Deep*. Her translations include *The Outbreak of the French Revolution*, by Erckmann-Chatrian (1871); *Thorwaldsen, His Life and Works*, by E. Plon (1873); and *The Memoirs of Madame Rémusat* (1881).

HÖFER, EDMUND, a German novelist; born at Greifswald, Oct. 19, 1819; studied philology and history at Greifswald, Berlin and Heidelberg. He devoted himself to writing, and produced many novels which had a wide popularity. His descriptions of Pomeranian peasant-life are excellent, but he wrote too much to always write well, and only a few of his works have permanent value. Among his stories are *Auf Deutscher Erde* (1860); and *Land und Seenovellen* (1871). He also wrote a *History of German Literature* (1876); and *Wie das Volk Spricht* (1876), a collection of rustic sayings. He died at Cannstatt, May 23, 1882.

HOFFMAN, CHARLES FENNO, an American author; born in New York City in 1806. When he was 11 years old his leg was crushed and had to be amputated above the knee. After studying law at Columbia College he was admitted to the bar in 1827. In 1833 he was the chief editor of the *Knickerbocker Magazine*. After a trip through the West, he wrote *A Winter in the West* (1835); and *Wild Scenes in the Forest and the Prairie* (1837); and a novel, *Greyslaer* (1840). He also wrote poetry. The first volume is called *The Vigil of Faith* (1842); and the second, *Borrowed Notes for Home Circulation* (1844). He was the author of *The Administration of Jacob Leisler*, in Sparks's American Biography Series (1848); and *The Pioneers of New York* (1848). A mental disorder which attacked him in 1849 closed his literary career. He died in Harrisburg, Pennsylvania, June 7, 1884.

HOFFMAN, DAVID, an American lawyer and author; born in Baltimore, Dec. 25, 1784; was professor of law in the University of Maryland from 1817 to 1836. He spent two years in travel in Europe, and on his return began the practice of law in Philadelphia. He published a *Course of Legal Study* (1817), which has been highly commended. He also wrote or compiled *Chronicles Selected from the Originals of Cartaphilus, the Wandering Jew* (1853); *Legal Outlines* (1836); *Miscellaneous Thoughts on Men, Manners and Things* (1837); and *Legal Hints* (1846). He died in New York City, Nov. 11, 1854.

HOFFMAN, EUGENE AUGUSTUS, an American clergyman; born in New York City, March 21, 1829. After graduating at Harvard College in 1848, he attended the General Theological Seminary, where he graduated in 1851; was rector, successively, of Grace Church, Elizabeth, New Jersey; of St. Mary's Church, Burlington, New Jersey; of Grace Church, Brooklyn Heights, New York; and of St. Martin's Church, Philadelphia, Pennsylvania. In 1879 he was appointed dean of the General Theological Seminary, and made large donations to this institution. He wrote a number of religious articles and historical papers.

HOFFMAN, MURRAY, an American jurist; born in New York City, Sept. 29, 1791; after graduating at Columbia College in 1809, he studied law and was admitted to the bar; was assistant vice-chancellor

from 1839 to 1843, and judge of the superior court of New York from 1853 to 1861. He wrote quite largely on law topics, both civil and ecclesiastical. Among his best-known writings are *Reports of Cases, Court of Vice-Chancery* (1839-40); *On the Law of the Protestant Episcopal Church in the United States* (1850); *Ecclesiastical Law in the State of New York* (1868); *Law and Practices as to References, and the Powers and Duties of Referees* (1875). He died in Flushing, Long Island, May 7, 1878.

HOFFMAN, WALTER JAMES, an American ethnologist; born at Weidasville, Pennsylvania, May 30, 1846; was graduated from Jefferson Medical College, Philadelphia, Pennsylvania, in 1866, and after practicing at Reading, Pennsylvania, until the outbreak of the Franco-Prussian war, was commissioned surgeon in the Prussian army. On his return from Prussia he was appointed acting assistant surgeon in the United States army, and attached as naturalist to the expedition for the exploration of Nevada and Arizona; detailed as surgeon to the expedition for the selection, along the Yellowstone River, of a route for the Northern Pacific railroad. At the organization of the ethnological bureau in 1879, he was appointed assistant ethnologist. Dr. Hoffman published numerous articles on ethnology, biology and folk-lore. He was ten times decorated by foreign powers for his services in medicine and science.

HOFFMANN, FRIEDRICH, a German physician; born at Halle, Feb. 19, 1660; studied at Jena, and afterward traveled in England and Holland. On the opening of the University at Halle, he was appointed to the professorship of medicine. In 1708 he was appointed body-physician to Frederick I of Prussia, but still retained his professorship. Hoffmann rendered important services to practical medicine by his experiments with various remedies. He was one of the first to bring mineral waters into general use. He wrote, in Latin, *Systema Medicinæ Rationalis* (1718-40), a work in nine volumes. His name is perpetuated by HOFFMANN'S ANODYNE. He died at Halle, Nov. 12, 1742.

HOFFMANN VON FALLERSLEBEN. See HOFFMANN, AUGUST HEINRICH, Vol. XII, p. 44.

HOFLER, KARL ADOLPH KONSTANTIN RITTER, a German historian; born at Memmingen, in Bavaria, March 26, 1811; educated at Munich and Göttingen, and in Italy; professor of history in Munich, and after 1851 at Prague. The most prominent of his writings are *Die Deutschen Päpste* (1839); *Papst Adrian VI* (1880); *Abhandlungen aus dem Gebiet der Slavischen Geschichte* (1883).

HOFMANN, AUGUST WILHELM, a German chemist; born at Giessen, April 8, 1818. After obtaining the degree of doctor of philosophy he became assistant to Liebig in the laboratory at Giessen, and on the establishment of the Royal College of Chemistry in London in 1845, was made superintendent of the new institution. From 1856 to 1865 he was chemist to the Royal Mint, and in 1865 accepted an appointment as professor of chemistry in the University of Berlin. He made important discoveries in chemistry (see ANILINE, Vol. II, p. 48), and contributed numerous papers to the transactions of scien-

tific societies, for the most part on the highest departments of organic chemistry. At Liebig's death Hofmann became editor of the *Annalen der Chemie*. He was ennobled on his seventieth birthday. He died in Berlin, May 5, 1892.

HOFMEYER, HON. JAN H., South African journalist and politician, was born July 4, 1845, and educated at Cape Town. He is the leader of the Afrikaner Bond, and has often represented Cape Colony at Colonial and other conferences. For some years Mr. Cecil Rhodes found him a staunch ally; but after the Jameson Raid he broke with Mr. Rhodes, and in the elections of 1898, as wire-puller of the Bond caucus, was active in his opposition to him. At one time Mr. Hofmeyr advocated total separation of South Africa from England; but after the Transvaal war of 1882 he acted as mediator between the Boers and the Cape Government, especially over the Swaziland question, and it was through his influence that a solution of the difficulty was arrived at. He was prominent in the negotiations which followed on the Bloemfontein Conference (1899), and his influence induced President Kruger to offer a better franchise than that which he had put forward at the Conference, but failed to persuade him to grant the five years' franchise.

HOGG, JABEZ, an English surgeon and writer; born at Chatham, April 4, 1817; studied at Gill's school in company with Charles Dickens; at the age of 15 he was apprenticed to a medical practitioner, after which he went to London and took up literary work. He brought out *The History, Construction and Application of the Microscope* (1854), which has passed through many editions and still remains the textbook of the microscope. He died April 23, 1880.

HOGG, QUINTIN, an English philanthropist; born in February, 1845. He early took a special interest in the education of homeless boys, young mechanics and artisans in London. In 1873 he started an institute for this purpose, which in 1893 had twelve thousand members. The work of the institute, known as the Polytechnic, is of a threefold character,—social, educational and religious,—but attendance at religious meetings is optional. During the nine years preceding 1891, Mr. Hogg expended over five hundred thousand dollars in the institute work.

HOG-GUM, a name applied to various gums used in the arts and in medicine. It is a product of various tropical trees of both hemispheres, notably *Spondias mangifera* of India, whose yellowish fruit is called wild mango.

HOG-PLUM, a name ordinarily applied to the plum-like fruit of the various species of *Spondias*, a genus of *Anacardiaceæ*. The species are natives of the East and West Indies, and also of India and Brazil.

HOGUE, CAPE DE LA, the northernmost point of the department of Manche, northwestern France, in lat. 49° 44' N., long. 1° 56' W., in the English Channel.

HOHENLOHE, PRINCE CLODWIG KARL VICTOR, a German Chancellor, and Prime Minister of Prussia, was born March 31, 1819. In 1841 he entered the University of Göttingen, and in 1845 he became a member of Parliament in Bavaria. He af-

terward represented the kingdom as ambassador at the Papal, Italian and Greek courts. In 1870



PRINCE HOHENLOHE.

he took his seat in the House of Peers. After the close of the Franco-German war he became a member of the first Imperial Parliament; three years later he succeeded Count Arnim as German representative at Paris, and attended the congress of Berlin that was held in 1878. In the same year he entered the Reichstag. On the death of General Manteuffel, governor of Alsace-Lorraine in 1885, he succeeded to the governorship, retaining that office up to his promotion, in October, 1894, to the position of Chancellor of the German Empire and Prussian Prime Minister. This office Prince Hohenlohe resigned Oct. 1900. See HOHENLOHE, Vol. XII, p. 51.

HOHENSTAUFFEN FAMILY. See GERMANY, Vol. X, pp. 488-490.

HOHENZOLLERN, LEOPOLD, PRINCE OF. See Vol. XII, p. 52; and FRANCE, Vol. IX, p. 620.

HOKUSAI, KATSUSHIKA, a Japanese artist; born in 1760; famous for his illustrations of Japanese scenery, costumes and life. His work is preserved in the *Hokusai Tchon* and the *Fuji Hiakké*, which contain one hundred views of the famous volcanic mountain, the scene of annual Buddhist pilgrimages. His drawings have furnished ideas and suggestions to all manner of artistic workmen on Japanese subjects. He died in 1849.

HOLBROOK, JOHN EDWARDS, an American naturalist; born at Beaufort, South Carolina, Dec. 31, 1795. After receiving his degree of M.D. from the University of Pennsylvania, he went to Europe to continue his medical studies there, especially at Paris. In 1824 he was made professor of anatomy in the Medical College of South Carolina, which position he held for more than thirty years. During the Civil War he served as surgeon in a South Carolina regiment. His chief work is *American Herpetology*, published in 1842. He died at Norfolk, Massachusetts, Sept. 8, 1871.

HOLCOMBE, JAMES PHILEMON, an American lawyer and author; born at Lynchburg, Virginia, in 1820; educated at Yale College and the University of Virginia; professor of law in University of Virginia (1852-60); a member of the Confederate Congress from 1861 to 1863; principal of a high school from 1868 to 1873. He was the author of numerous magazine articles and also wrote a number of papers on legal questions, chief among which are *Introduction to Equity Jurisprudence* (1846); *Law of Debtor and Creditor in the United States and Canada* (1848); *Literature and Letters* (1868). He died in Capon Springs, Virginia, Aug. 26, 1873.

HOLDEN, a city of Johnson County, central western Missouri, on the Missouri, Kansas and Texas and the Missouri Pacific railroads, 42 miles S.E. of Kansas City. Farming is carried on in the neigh-

borhood, and timber, building-stone and coal are obtained in abundance. It has grain-elevators, flour and grist mills, schools, water-works, hotels, St. Cecilia's Seminary, etc. Population 1890, 2,520.

HOLDEN, EDWARD SINGLETON, an American astronomer; born in St. Louis, Missouri, Nov. 5, 1846. He studied at West Point, and subsequently held several positions in the army, as instructor in mathematics and philosophy. He resigned from the army in 1873, and was appointed professor of mathematics in the navy, where he was assigned to duty in the naval observatory as assistant to Professor Newcomb. The telegraph time-ball in New York was planned by him. In 1881 he became professor of astronomy in the University of Wisconsin and director of the new Washburn Observatory, where he remained, with brief intermissions, until 1886, and published four volumes of observations. In 1883 he visited the Caroline Islands to observe a total eclipse of the sun; in 1896 was chosen president of the University of California and director of the Lick Observatory on Mount Hamilton, San José. He published *Astronomy for Students* (1880); *Sir William Herschel: His Life and Works* (1881); *Hand-book of Lick Observatory* (1888).

HOLDER, JOSEPH BASSETT, an American zoölogist; born at Lynn, Massachusetts, Oct. 26, 1824. In 1860 he entered the United States army, and was surgeon-in-charge at the United States military prison in Tortugas, Florida, until 1867, and then was assistant post-surgeon at Fortress Monroe, Virginia. In 1870 he was made curator of invertebrate zoölogy, ichthyology and herpetology in the American Museum of Natural History, New York, of which he was one of the founders. His principal works are a *History of North American Fauna* (1882); *History of the Atlantic Right Whales* (1883); *The Living World* (1884). He died Feb. 28, 1888.

HOLDREGE, a city and the capital of Phelps County, central southern Nebraska, on the Burlington and Missouri River railroad, 23 miles S.W. of Kearney. It has flour-mills, brick and marble yards and grain-elevators. It is a great-cattle and hog market. It is supplied with electric lights and water-works. Pop. 1890, 2,601; 1900, 3,007.

HOLD-THE-RENT MANIFESTO. See HOME RULE, in these Supplements.

HOLE, SAMUEL REYNOLDS, an English clergyman and author, Dean of Rochester; born Dec. 5, 1819; educated at the grammar school, Newark-on-Trent and at Brasenose College, Oxford; ordained deacon, 1844; priest, 1845; vicar, 1850; prebendary of Lincoln, 1875; dean of Rochester, 1887. He is the author of *A Little Tour in Ireland*, illustrated by John Leech (1858); *A Book about Roses* (1859); *Six of Spades* (1860); *Nice and Her Neighbors* (1881); *Book about the Garden* (1892); *Memories of Dean Hole* (1892); *More Memories* (1894); *A Little Tour in America* (1895).

HOLE, WILLIAM, an English artist; born at Salisbury, Nov. 7, 1846. After studying at the University of Edinburgh he was apprenticed to a firm of civil engineers; four years later he visited Rome, where his latent artistic instincts were developed, causing him, on his return to Edinburgh, to

give up engineering for art. He was trained at the Edinburgh School of Art, and under Cameron and Chalmers at the school of the Royal Scottish Academy. Mr. Hole's distinction was gained chiefly through his power as an etcher. Among his leading pictures are *The Evening of Culloden* (1880); *Prince Charlie's Parliament* (1881); *Gethsemane* (1887). His principal original etchings are *Quasi Cursors* (1884); portraits of the professors of Edinburgh University; and *The Canterbury Pilgrims* (1888).

**HOLGUIN**, a city of Santiago de Cuba, eastern Cuba, 115 miles E.S.E. of Puerto Principe. It is on the Rio Salado, near its source, in a fertile plain, which produces cattle, maize, tobacco and timber. The place was settled in 1720, and received its city charter in 1751. Population 1894, nearly 10,000.

**HOLIDAY**, in legal terms, imports Sunday, Christmasday and any other day appointed as a public festival or fast day. (See **FESTIVALS**, Vol. IX, pp. 113-119.) The old English holidays, which had their origin and obtained their name in mediæval England when the state religion was that of the Church of Rome, are still observed in some parts of England, Scotland and Ireland. These holidays are as follows:

January 6th, Twelfth day, sometimes called Old Christmas day, the same as Epiphany; February 2d, Candlemas, the Festival of the Purification of the Virgin; February 14th, Old Candlemas, St. Valentine's day; March 25th, Lady day, the Annunciation of the Virgin; April 6th, Old Lady day; June 24th, Midsummer day, Feast of the Nativity of John the Baptist; July 7th, Old Midsummer day; August 1st, Lammas day, originally the festival of the wheat-harvest, but in the church the festival of St. Peter's miraculous deliverance from prison; August 13th, Old Lammas day; September 29th, the Feast of St. Michael the Archangel; October 11th, Old Michaelmas day; November 1st, Allhallowmas; November 2d, All Souls' day; November 11th, Martinmas; and December 28th, Childermas, or Holy Innocents' day.

Lady day, Midsummer day, Michaelmas and Christmas are quarter (or rent) days in England, and Whitsunday, Martinmas, Candlemas, and Lammas day in Scotland. Shrove Tuesday, the day before Ash Wednesday, and Maundy Thursday, the day before Good Friday, are observed by the church. Mothing or Refreshment Sunday is Mid-Lent Sunday, on which the old rural custom obtains of visiting one's parents with presents.

Legal holidays in the United States are days appointed by law to be kept as holidays, especially as regards the closing of public offices and the suspension of judicial proceedings and general business. A list of the legal holidays observed by the various states is as follows:

**JANUARY 1** (*New Year's day*). In all the states except Arkansas, Massachusetts, Mississippi, New Hampshire and Rhode Island.

**JANUARY 8** (*anniversary of the battle of New Orleans*). In Louisiana.

**JANUARY 10** (*Lee's birthday*). In Florida, Georgia, North Carolina and Virginia.

**FEBRUARY 12** (*Lincoln's birthday*). In Illinois, Minnesota, New Jersey, New York and Washington (state).

**MARDI GRAS**. In Alabama and the parish of Orleans, Louisiana.

**FEBRUARY 22** (*Washington's birthday*). In all the states, except Arkansas, Iowa and Mississippi.

**MARCH 2** (*anniversary of Texan independence*). In Texas.

**MARCH 4** (*Firemen's anniversary*). In New Orleans, Louisiana.

**STATE ELECTION DAY** In Rhode Island.

**GOOD FRIDAY**. In Alabama, Louisiana, Maryland, Pennsylvania and Tennessee.

**APRIL 19** (*Patriots' day*). In Massachusetts.

**APRIL 21** (*anniversary of the battle of San Jacinto*). In Texas.

**MEMORIAL DAY**. In Alabama, Florida and Georgia.

**MEMORIAL DAY**. In North Carolina.

**MAY 20** (*anniversary of the signing of the Mecklenburg declaration of independence*). In North Carolina.

**DECORATION DAY**. In Arizona, California, Colorado, Connecticut, Delaware, District of Columbia, Illinois, Indiana, Iowa, Kansas, Kentucky, Maine, Maryland, Massachusetts, Michigan, Minnesota, Missouri, Montana, Nebraska, Nevada, New Hampshire, New Jersey, New York, North Dakota, Ohio, Oklahoma, Oregon, Pennsylvania, Rhode Island, Tennessee, Utah, Vermont, Wisconsin, Washington and Wyoming.

**JUNE 3** (*Jefferson Davis's birthday*). In Florida.

**JULY 4** (*Independence day*). In all the states.

**JULY 24** (*Pioneers' day*). In Utah.

**AUGUST 16** (*Bennington battle day*). In Vermont.

**LABOR DAY**. In Alabama, California, Colorado, Connecticut, Delaware, Florida, Georgia, Illinois, Indiana, Iowa, Kansas, Louisiana, Maine, Maryland, Massachusetts, Michigan, Minnesota, Missouri, Montana, Nebraska, New Hampshire, New Jersey, New York, Ohio, Oregon, Pennsylvania, Rhode Island, South Carolina, South Dakota, Tennessee, Texas, Utah, Virginia, Washington and Wyoming.

**SEPTEMBER 9** (*Admission day*). In California.

**OCTOBER 15** (*Lincoln day*). In Connecticut.

**OCTOBER 31** (*Admission day*). In Nevada.

**NOVEMBER 1** (*All Saints' day*). In Louisiana.

**GENERAL ELECTION DAY**. In Arizona, California, Colorado, Idaho, Indiana, Iowa, Kansas, Maryland, Minnesota, Missouri, Montana, Nevada, New Hampshire, New Jersey, New York, North Dakota, Ohio, Pennsylvania, Rhode Island, South Carolina, South Dakota, Tennessee, Texas, West Virginia, Washington, Wisconsin and Wyoming.

**THANKSGIVING DAY**. Observed in all the states, though in some it is not a statutory holiday.

**DECEMBER 25** (*Christmas day*). In all the states.

Sundays and fast days are legal holidays in all the states which designate them as such.

There are no statutory holidays in Arkansas and Mississippi, but by common consent the Fourth of July and Christmas are observed as holidays.

*Arbor day* is a quasi holiday in Colorado, Kansas, Minnesota, North Dakota, Wisconsin and Wyoming, the day being set by the governor; in Texas, February 22d; in Nebraska, April 22d; Montana, third Tuesday in April; Utah, first Saturday in April; Rhode Island, first Friday in May; and Idaho, on Friday after May 1st.

Every Saturday after twelve o'clock noon is a legal holiday in New York, New Jersey, Pennsylvania and Maryland, and the cities of New Orleans and Wilmington, Delaware, and June 1st to September 30th in Newcastle County, Delaware, and Denver, Colorado.

There is no national holiday, not even the Fourth of July. Congress has at various times appointed special holidays. In the second session of the Fifty-third Congress it passed an act making Labor Day a public holiday in the District of Columbia, and it has recognized the existence of certain days as holidays, for commercial purposes, in such legislation as the Bankruptcy Act, but with the exception named there is no general statute on the subject. The proclamation of the President designating a day of thanksgiving only makes it a holiday in those states which provide by law for it. The Federal Courts and officers of the United States government, however, observe the legal holidays of the states in which they are located.

**HOLL**, a family of English artists descended from **WILLIAM HOLL**, an engraver of note in the early part of the nineteenth century. He was the father of two eminent engravers, **WILLIAM**, born at Plaistow in 1807, and **FRANCIS**, born at Camder Town, March 23, 1815. **WILLIAM** studied under



his father, and after devoting himself for a considerable time to work in portraiture and illustration, began engraving after William Powell Frith and George Richmond. He was not a prolific artist. His best-known works are *An English Merry-making a Hundred Years Ago*; the *Village Pastor*, after Frith; and *Rebekah*, after Richmond. Died in London, Jan. 30, 1871.

FRANCIS, like his brother, got his training from his father, and like his brother, also, worked principally after Frith and Richmond in some of their best productions. Holl's success with Richmond's work, which was almost exclusively portraiture, led to court patronage. His best-known works are the *Railway Station* and *Coming of Age*, after Frith, and his illustrations in Martin's *Life of the Prince Consort*. He died at Godalming, Jan. 14, 1884.—FRANK HOLL, a son of Francis, was born July 4, 1845, in London, and educated at University College, in that city. He became a student at the Royal Academy, and at the age of 19 exhibited a portrait, and a picture called *Turned Out of Church*. In 1868 he produced a picture entitled *The Lord Giveth and the Lord Hath Taken Away*, which gained for him a two-years' traveling scholarship. During his later years he devoted himself to portrait-painting, and his work in this line includes many of the most prominent men in England. Some of his best-known productions are *A Village Funeral*; *Her Firstborn*; *No Tidings from the Sea*. Mr. Holl became a member of the Royal Academy in 1883. He died in London, July 31, 1888.

HOLLAND. See Vol. XII, pp. 59-98; and NETHERLANDS, in these Supplements.

HOLLAND, a city of Ottawa County, central western south Michigan, on the Black River, and on the Chicago and West Michigan railroad, 4 miles E. of Lake Michigan. It is the seat of Hope College, a co-educational institution of the Reformed Church, having 256 students and 13 instructors in 1898; has iron-smelting furnaces, mills, and tanneries. It is largely populated by Hollanders. Population 1890, 3,945; 1900, 7,790.

HOLLAND, JOSIAH GILBERT, an American journalist and novelist; born at Belchertown, Massachusetts, July 24, 1819. After graduating at Berkshire Medical College, Pittsfield, Massachusetts, he practiced medicine for three years and then became superintendent of public schools at Vicksburg, Mississippi. In 1849 he became associate editor of the *Springfield Republican*. In 1866 he sold his interest in the *Republican* and traveled for some time in Europe.

*Scribner's Magazine* was established by him in 1870, and of it and its successor, *The Century Magazine*, he remained editor until his death. Having removed to New York, Dr. Holland be-

came president of the Board of Education of New York city, and also chairman of the board of trustees of the College of the City of New York. A large number of works were written and published by him, all of which were of the highest moral tone, and many of which obtained very great popularity. Some of the best known of these works are *History of Western Massachusetts* (1855); *Letters to Young People* (1858); *Married and Single* (1858); *Bitter Sweet: A Poem in Dramatic Form* (1858); *Gold Foil* (1859); *Miss Gilbert's Career* (1860); *Arthur Bonnicastle* (1873); *The Story of Seven Oaks* (1875); *Nicholas Minturn* (1876); and *Complete Poetical Works* (1879). Died in New York city, Oct. 12, 1881.

HOLLAND, ROBERT AFTON, an American clergyman and author; born in Nashville, Tennessee, June 1, 1844. At the age of 17 he became a Methodist preacher, and in the following year chaplain of a brigade in the Confederate army. At the close of the war he was called to the pastorate of Trinity Methodist Church, Baltimore, and became editor of the *Christian Advocate*, published in that city. In 1872 he joined the Protestant Episcopal Church, and after that time held charges in St. Louis, New Orleans, and Chicago. A number of his sermons and articles on religious topics have been published. Among his publications are *The Philosophy of the Real Presence*; *The Proof of Immortality*; and *Democracy in the Church*.

HOLLAND, THOMAS ERSKINE, an English writer on jurisprudence; born at Brighton, July 17, 1835; educated at Oxford, and called to the bar in 1863; was frequently lecturer and law examiner at Oxford, University of London, and at Cambridge; probably best known by his *Elements of Jurisprudence* (1880), which became a textbook in most English and American universities and law schools. In addition, he published *Essays on the Form of the Laws* (1870); *The Institutes of Justinian as a Recension of the Institutes of Gaius* (1873); *A Manual of Naval Prize Law* (1888); *Studies in International Law* (1898).

HOLLEY, a village of Orleans County, northwestern New York, 22 miles W. of Rochester, on the New York Central and Hudson River railroad, and on the Erie canal. It exports farm produce, Medina sandstone, cider, vinegar, and evaporated apples. Its evaporating establishment is the largest in the state. It has good schools, good water-supply, and electric lights. Population 1900, 1,385.

HOLLEY, ALEXANDER LYMAN, an American metallurgist and engineer; born at Lakeville, Connecticut, July 20, 1832; graduated from Brown University and took up practical work at the Corliss steam-engine works. From 1856 to 1863 he was a contributor to and editor of various engineering journals, and in connection with Colburn published his *Railway Economy: A Report on European Railways* (1858). The Bessemer process of steel-making was introduced by him into the United States in 1865, and steel-works and rolling-mills were built by him at Har-



DR. JOSIAH G. HOLLAND.

risburg, Troy, Chicago, Joliet, and Pittsburg. In the same year he published *A Treatise on Ordnance and Armor*. Mr. Holley was consulting engineer to a large number of steel-works; was connected with various scientific societies; and achieved the rare distinction of being a leading authority in three separate lines—railways, ordnance, and steel-manufacture. He died in Brooklyn, N. Y., Jan. 29, 1882.

**HOLLIDAYSBURG**, a borough and the capital of Blair County, southwestern central Pennsylvania, on a branch of the Juniata River, and on the Pennsylvania railroad. It has furnaces, foundries, rolling-mills, and nail factories. Population 1890, 2,975; 1900, 2,998.

**HOLLINGSHEAD, JOHN**, an English author; and theatrical manager; born in London, Sept. 9, 1827. He joined the staff of *Household Words* in 1857; was a constant contributor to that periodical and to *All the Year Round*, *Cornhill Magazine*, *Good Words*, and *Once a Week*. From 1859 to 1864 he published several volumes of essays and stories, chiefly on life in London. He wrote several original dramatic pieces; among them, *Rubbing the Gilt Off* and *Rough Diamonds*. He was for ten years the dramatic critic of the *Daily News*, *London Review*, etc., and became a member of the Dramatic Authors' Society. Mr. Hollingshead opened the Gaiety Theatre, in the Strand, in Dec. 1868. He had three metropolitan theaters under his direction at one time, with the most powerful combination of actors in London. He was also the director of the principal theater in Manchester. In 1879 he induced the whole Comédie Française to visit London and play for six weeks at the Gaiety.

**HOLLIS**, a town of southern Hillsboro County, New Hampshire, on the Nashua River, 5 miles S.W. of Nashua, and on the Boston and Maine railroad. It is engaged in agriculture and the manufacture of lumber and caskets. Population 1890, 1,000, 1900, 910.

**HOLLISTER**, a town and capital of San Benito County, central California, 94 miles S. of San Francisco, by the Southern Pacific railroad. Tobacco and grain and fruits are raised in the vicinity, while coal and quicksilver are found in the surrounding mountains. Wool and wine are also exported. A complete system of irrigation has been introduced with success. Population 1890, 1,234; 1900, 1,315.

**HOLLISTON**, a manufacturing town of southern Middlesex County, Massachusetts, 26 miles S.W. of Boston, on the Boston and Albany railroad. It manufactures boots, shoes, harness, straw and woolen goods, nails, wrenches and pumps. Population 1890, 2,619; 1900, 2,598.

**HOLLOWAY COLLEGE, THE ROYAL**, an institution at Egham, England, for the higher education of women. It is connected with the universities of London, and provides the instruction necessary for the London degrees in science and arts, the preliminary M.B., and for the examinations of the University of Oxford. Instruction is also provided in music, drawing and painting.

There were, in 1896, 88 students, 8 resident women lecturers, and 10 non-resident lecturers and professors. No student may enter the college for less than one year, nor reside for more than four, without special leave.

**HOLLY**, a post village of Oakland county, southeastern South Michigan, 52 miles N.W. of Detroit; on the Detroit, Grand Haven and Milwaukee and the Flint and Pere Marquette railroads. Ice is shipped, and the manufactures are furniture, boxes, pickles and vinegar, lumber, flour and castings. Population 1890, 1,266; 1900, 1,419.

**HOLLY OAK**. See **HOLM OAK**, in these Supplements.

**HOLLY SPRINGS**, a city, railroad junction and the capital of Marshall County, central northern Mississippi, noted for its educational institutions. Rust University (Methodist), Franklin Female College (non-sectarian), Bethlehem Academy (Roman Catholic), Maury Institute (non-sectarian), and the State Normal School are located here. It is a cotton-shipping point, and manufactures hubs, spokes, wagons, and contains potteries and marble-works. Population 1900, 2,815.

**HOLMAN, AGNES**, the stage name of **GILFERT, AGNES**; q.v., in these Supplements.

**HOLMAN, WILLIAM STEELE**, an American statesman; born in Dearborn County, Indiana, Sept. 6, 1822. He was admitted to the Indiana bar, and from 1843 to 1846 was judge of the probate court. From 1847 to 1849 he was prosecuting attorney; was a member of the legislature in 1851, and was a judge of the court of common pleas from 1852 to 1856. He was a Democratic member of the successive Congresses from the 36th to the 53d, except the 45th and 46th. From his opposition to all doubtful measures and schemes of lobbyists, he gained the title of "The Great Objector." He was defeated for Congress in 1894. Died in Washington, D.C., April 22, 1897.

**HOLMES, AUGUSTA MARY ANNE**, a French composer; born in Paris, Dec. 16, 1847, of Irish parents. Her musical education was completed in Paris under Lambert and Franck. Her works consist mostly of operas and symphonies. She produced the *Ode Triumphale* at the Paris Exposition in 1889; an opera, *La Montagne Noire*, was produced by the Grand Opera at Paris in 1895. Among her other compositions are *Hero and Leander*, an opera; *In Exitu Israel*, a psalm; and a symphonic ode with choruses, *Ludus pro Patria*.

**HOLMES, GEORGE FREDERICK**, an American educator; born in Georgetown, British Guiana, Aug. 2, 1820. He was a teacher in Virginia, Georgia and South Carolina, and in 1842 was admitted to the South Carolina bar. In 1845 he became a professor in Richmond College, Virginia; in 1846 president of the University of Mississippi; in 1847 professor of political economy, history, and international law in William and Mary College; and in 1857 professor of history and literature in the University of Virginia. He published a series of text-books used in Southern schools. Died at Richmond, Va., Nov. 4, 1897.

HOLMES, MARY JANE HAWES, an American novelist, born at Brookfield, Massachusetts. Her father was a brother of Dr. Joel Hawes. She married Daniel Holmes, and resided in Versailles, Kentucky, and Brockport, New York. Her numerous novels are of a domestic character and of a high moral tone. Some of the best known are *Tempest and Sunshine* (1854); *Lena Rivers* (1856); and *Madeline* (1881).

HOLMES, NATHANIEL, an American jurist and Shakespearean scholar; born at Peterboro, New Hampshire, July 2, 1814. After graduating from Harvard he studied law and was admitted to the bar in 1839; was judge of the supreme court of Missouri from 1865 to 1868, and professor of law in Harvard University from 1868 to 1872. Mr. Holmes was well known as a believer in and advocate of the Baconian theory of the authorship of Shakespeare's plays, and in 1866 published *The Authorship of Shakespeare*.

HOLMES, OLIVER WENDELL, an American surgeon, poet and essayist; born at Cambridge,

Massachusetts, Aug. 29, 1809, and died at Boston, Oct. 7, 1894. He was the son of the Rev. Abiel Holmes, a Congregational minister, and of Sarah Wendell, of Dutch ancestry, and related to many well-known families in New England. He entered Harvard College at the age of 16, and graduated in 1829, in a class,

many of whose members afterward became famous. For a time he studied law, but later on abandoned it for a course in medicine at Harvard, whence he went to the hospitals of Paris, and, returning, took the M.D. degree at his *alma mater* in 1836. Two years afterward he was appointed professor of anatomy and physiology at Dartmouth College, and in 1847 was called to the same chair in the Massachusetts Medical School, Boston, a post which he held for 35 years. He became distinguished as an anatomist, and was the first to establish the infectiousness of puerperal fever. In 1882, at the age of 73 he retired from his professorship. His literary career dates from his student days, when he found amusement in dashing off quaint and humorous verse, the first collection of which appeared in 1836, supplemented by a further volume in 1848. Selections from both of these volumes were at an early period published in England, where they won a wide audience.

The poems are mainly short pieces, attuned to a delicate ear, and many of them exquisitely wrought. Others belong to the class known as *vers d'occasion*, delightful conceits, playful and witty, and turned out with great felicity of expression. A few, such as *The Voiceless*, *Nearing the Snow-Line*, and *The Last Leaf*, are half-serious effusions, with a pathos that touches all hearts:

while others, again, like *The Chambered Nautilus*, in which he used a meter of his own devising, belong to the highest type of verse. It is as a poet of humor that Holmes is likely to remain best known—the vein that he worked at his happiest at anniversary gatherings, banquets, and celebrations. He has a masterly command of metric form, with an uncommon freshness and originality. His later collections of verse are *Songs in Many Keys* (1862); *Songs of Many Seasons* (1875), *The Iron Gate, and Other Poems* (1880); and *Before the Curfew, and Other Poems* (1888.)

In Holmes's correspondence (*Life and Letters*, edited by John T. Morse, Jr., 2 vols., Boston, 1896), the grave and gay commingle, as they do, also, in the poet's most characteristic prose writings, the series of discursive philosophizings and personal talks, styled *The Autocrat of the Breakfast-Table* (1857-58). The work originally appeared as contributions to the *Atlantic Monthly*. In the same vehicle appeared, in 1860, *The Professor at the Breakfast Table*, and, after a lengthened interval, *The Poet at the Breakfast-Table* (1872). The first of the series is the best. Here the distinctive charm of the man comes freely out, and in reading the sparkling pages one hardly knows which most to admire—the wit or the wisdom of the writer, his half-bantering chidings and criticisms, or the delightfully familiar and amusingly unconventional character of his personal confidences.

In his two notable novels, *Elsie Venner* (1859) and *The Guardian Angel* (1867), Dr. Holmes writes purposively, and as a medical man and scientific observer. The former is a study of heredity as affected by prenatal influences; the latter, which is a less weird and more artistic story, is a fine historical and semibiographical study, with an admirable New England setting. To these he added a third novel in 1885, entitled *A Mortal Antipathy*, in which the hero, a weak and uninteresting character, has a repulsive feeling for a young and pretty cousin, owing to her having caused him to fall from a balcony in his childhood.

The further serious side of Holmes's personality we see in quasi-scientific essays, written with an eye to popular acceptance, in the intervals of an active and engrossing professional career. These include *Currents and Counter-Currents* (1861); *Border-Lines of Knowledge* (1862); *Soundings from the Atlantic* (1864); and *Mechanism in Thought and Morals* (1871). Even here there is much of the buoyancy of manner and sprightliness of thought habitual to him. Of these qualities he could never divest himself, even in his most intellectual prelections, and where his personal antipathies, as in the case of rigid theological creeds, would excite him to the point of vehement denunciation and sometimes to heretical irreverence.

Holmes's faculty for memoir-writing was not great. His *Life of John Lothrop Motley* (1878) and that of *Ralph Waldo Emerson* (1885) are respectable performances, but cannot be satisfactory to the admirers of either. Both works have many



OLIVER W. HOLMES.

brilliant and suggestive passages in the writer's characteristic vein; but neither quite achieves a success. In 1886 Dr. Holmes visited Europe, and in Britain came into pleasant contact with many admirers. A record of this tour was published under the title of *One Hundred Days in Europe* (1887). While in the United Kingdom the great universities conferred on him their academic honors. Cambridge made him a doctor of letters, Edinburgh gave him an LL.D.; and Oxford made him a doctor of laws. Holmes made a further annual appearance in letters in 1890, when he published *Over the Tea-cups*, full of the old-time wit, wisdom and humor, though the "Autocrat" himself speaks of it as "the wintry products of my freezing wits." He died four years later in his loved native city of Boston.

G. MERCER ADAM.

HOLMES, WILLIAM HENRY, an American archaeologist; born near Cadiz, Ohio, Dec. 1, 1846; became attached, as draftsman, to the Smithsonian Institution at Washington, in 1871, and in 1872 was appointed artist to the Hayden exploring expedition; from 1874 to 1882 he was connected with the Geological Survey; in 1882 he was made honorary curator of aboriginal pottery in the National Museum; and in 1889 was placed in charge of the archaeological explorations of the bureau of ethnology. He was elected professor of archaeological geology at the University of Chicago in 1892. Besides his writings, which include reports on the cliff ruins of the San Juan country and Hayden's *Atlas of Colorado*, he has done a large number of water-colors of western scenery, which have been largely used in the reports of the Geological Survey.

HOLM-OAK OR HOLLY-OAK, a beautiful evergreen oak (*Quercus ilex*), a native of southern Europe and northern Africa. It affords excellent timber.

HOLOCEPHALA. See ICHTHOLOGY, Vol. XII, p. 686.

HOLOFERNES. See JUDITH, Vol. XIII, p. 765.

HOLOPHYTES. See ECOLOGY, in these Supplements.

HOLOSTOMIDÆ. See TREMATODA, Vol. XXIII, p. 539.

HOLOTHURIDEA. See ECHINODERMATA, Vol. VII, pp. 639, 640.

HOLST, HERMANN EDUARD VON, a Russian-German historian; born at Fellin, Livonia, June 19, 1841; studied at Dorpat and Heidelberg; settled in St. Petersburg, but having, while traveling in Germany, written an article displeasing to the Russian government, he was forbidden to return, and soon after emigrated to the United States, where he engaged in literary and editorial work in New York. In 1872 he was appointed professor of history at Strasburg University, and two years later was called to the chair of modern history at Freiburg. He afterward revisited the United States and lectured at Johns Hopkins University. In 1892 he was called from Freiburg to the chair of history at the University of Chicago. His articles on the Monroe Doctrine in

1896 attracted wide attention. His principal work is *Verfassung und Demokratie der Vereinigten Staaten von Amerika*, translated by J. J. Lalor and A. B. Mason, under the title *The Constitutional and Political History of the United States* (1876-85). Among his other works are a *Life of John C. Calhoun* and *The Constitutional Law of the United States of America* (1887).

HOLSTEIN. See SCHLESWIG-HOLSTEIN, Vol. XXI, p. 415.

HOLSTON, a river of eastern Tennessee, rising in several branches in Smyth and Washington counties, western Virginia, on the eastern slope of the Clinch Mountains. It flows W.S.W. into Tennessee, receives the French Broad, the Little Tennessee and the Watega, joins the Clinch River at Kingston, Roane County, and forms the Tennessee. Its length is about 200 miles, and it is navigable for most of the distance for river-boats of light draft.

HOLT, JOSEPH, an American jurist; born in Breckinridge County, Kentucky, Jan. 6, 1807; studied at Center College, Danville, and St. Joseph's College, Bardstown. He was admitted to the Kentucky bar in 1828; in 1857 was appointed Commissioner of Patents; became Postmaster-General in 1859, and in 1860 assumed charge of the War Department; with the exception of General Cass, he was the only member of the old Buchanan Cabinet who did not sympathize with the South. In 1862 he was made judge-advocate-general of the army, and in 1864 was put at the head of the bureau of military justice. In 1865 he was brevetted major-general of the United States army, for faithful, meritorious and distinguished services in the bureau of military justice during the war, and in 1875, at his own request, was retired. He was conspicuous in various courts-martial and courts of justice, notably that before which President Lincoln's assassins were arraigned. He died in Washington, D. C., Aug. 1, 1894.

HOLTON, a city and the capital of Jackson County, northeastern Kansas, 56 miles W. of Leavenworth, on the Union Pacific, Missouri Pacific, the Kansas City North-Western, and the Chicago, Rock Island and Pacific railroads. It manufactures flour, and exports excellent fruit, good timber, live-stock and building-stone. It is the seat of Campbell University, a co-educational, non-sectarian institution with 550 students, opened in 1882. Population 1900, 3,082.

HOLTZENDORFF, FRANZ VON, a German jurist; born at Vietmannsdorf, in Brandenburg, Oct. 14, 1829. Educated for the law, he practiced in the courts at Berlin till 1857, when he became a lecturer on law at the university. Made professor there in 1861, he was called to Munich in 1873. He is known as an able writer on several branches of law, and especially as an advocate for the reform of prison and penal systems. Among the more important of his numerous works are *Französische Rechtszustände* (1859); *Prinzipien der Politik* (1869); and, with Jagemann, *Handbuch des Gefängniswesens* (1888). He died Feb. 4, 1888.

**HOLTZ MACHINE.** See **ELECTRICITY**, Vol. VIII, p. 102.

**HOLTZMANN, ADOLF**, a German archæologist, born at Carlsruhe, May 2, 1810. He first studied theology at Berlin, then Old German under Schmeller at Munich, and afterward Sanskrit under Burnouf, Paris. In 1852 he was appointed professor of German language and literature at Heidelberg. It was Holtzmann who first advanced the theory that manuscript C of the *Nibelungenlied* was the oldest form of the mediæval epic, and thus caused the war among students of German philology over the origin of the *Nibelungenlied*. Among his works are translations of the *Mahâbhârata* and the *Râmâyana*, and an *Old German Grammar*. He died at Heidelberg, July 3, 1870.

**HOLTZMANN, HEINRICH JULIUS**, a German theologian, son of Adolf Holtzmann; born at Carlsruhe, May 17, 1832. In 1861 he became extraordinary, in 1865 ordinary, professor of theology at Heidelberg, and in 1874 accepted a call to the theological faculty at Strasburg. He became one of the leaders of the advanced school. Among his writings are *Kanon und Tradition* (1859), and, with Zöpffel, *Lexikon für Theologie und Kirchenwesen* (1882).

**HOLY ALLIANCE.** See **AUSTRIA**, Vol. III, p. 135; **FRANCE**, Vol. IX, p. 619; and **MONROE DOCTRINE**, in these Supplements.

**HOLY BROTHERHOOD.** See **SPAIN**, Vol. XXII, p. 326.

**HOLY COMMUNION.** See **EUCCHARIST**, Vol. VIII, p. 651.

**HOLY GHOST.** The word *ghost* has here its proper meaning of spirit; and many religious writers now prefer the name *Holy Spirit*, owing to the associations suggested to certain minds by the word *ghost*.

The Holy Spirit is the third person in the Trinity, of the same substance with the Father and the Son, and co-eternal and co-equal with them.

The Christians of the first three centuries had no well-defined doctrine of the Holy Spirit. The formula of baptism and the apostolic benediction taught them to think of three divine persons as engaged in the work of our salvation, but naturally Christ attracted their chief reverence and affection, and challenged their chief thought. Yet they regarded Christ as inferior to the Father in nature, and naturally, therefore, regarded the Spirit as inferior to Christ in nature; and this gradation of the persons of the Trinity was taught by all the Fathers who wrote on the subject, as Justin, Tertullian and Origen.

In the fourth century, however, the study of the Scriptures led the orthodox Christians to believe that God exists naturally as a Trinity, and produces his Son by nature, and not by an act of will. It followed logically that the Son possesses the same nature with the Father, and that, though he may be subordinate in functions, he is not subordinate in nature. When this view was reached it was but a step to the conclusion

that the Spirit also possesses the divine nature equally with the Father and the Son. Yet it is not probable that a majority of the bishops who attended the council of Nicæa in A.D. 325 accepted this view of the Holy Spirit, and it was not set forth in the Nicene creed. But the statements of the Nicene creed concerning the Father and the Son led necessarily to the full doctrine of the Holy Spirit, and this doctrine was formulated at the council of Constantinople in 381. Thus the Christians of the fourth century were brought to the doctrine of the Holy Spirit almost without design, and as a natural result of their studies of Christ in his relations to the Father.

Up to this point the East and the West, the Greek and Latin branches of the church, had moved as one body in these inquiries. The East now paused, while the West proceeded further. If, as some affirm, there were traces of subordinationism in the creeds of Nicæa and Constantinople they were removed, for the West, by Augustine, who taught strenuously the contrary view. Again, the Nicene creed, as completed at Constantinople, in 381, declared that the Holy Spirit proceeds from the Father. But there were many in the Latin Church who believed that he proceeds from both the Father and the Son. Perhaps they were led to this view by the Arian objection to orthodoxy, that, if he proceeds from the Father only, the Son must be inferior to the Father. The third council of Toledo, in 589, declared that he proceeds from both. This council was not ecumenical, however, and had no authority to amend the creeds; but the statement was accepted gradually throughout the Western Church, though to this day it has never been promulgated officially by any ecumenical council or any pope. The general adoption of this statement in the West was a chief cause of the separation of the Latin and the Greek churches, and is now a chief impediment to their reunion. Protestant theologians, in general, teach the procession of the Spirit from both the Father and the Son, but they do this solely on Biblical grounds, and with the admission that the doctrine of the double procession has not been revealed so clearly as some others, and should not be made an occasion of divisions among brethren.

The offices of the Holy Spirit have not caused much controversy. It has always been held by all, that he inspired the prophets and the other writers of the Scriptures, and that he regenerates and sanctifies those who are saved.

*Literature:* Schaff, *The Creeds of Christendom*; the histories of doctrine and of dogma, by Hagenbach, Shedd, Fisher, Sheldon and Harnack; the histories of the church, by Neander, Schaff and others.

FRANKLIN JOHNSON.

**HOLY GHOST, ORDER OF THE**, a name given to various orders of the Roman Catholic Church, which have existed at different times since the twelfth century. The first, consisting of hospital knights of St. Augustine, was founded by Guido of Montpellier in 1178, and in part removed to Rome in 1204, receiving the hospital in

Sassia. Here they became, in part, canons regular, and the knightly branch, in 1700, ceased to exist. It 1254 the Hospitallers of the Holy Ghost, a secular branch of the above, containing both brothers and sisters, were organized. Another congregation of canons of the Holy Ghost was confirmed in 1588. The congregation of the Holy Ghost was founded in Paris by Claude Desplaces in 1703, and in 1848, after many vicissitudes, it was united with the Congregation of the Immaculate Heart of Mary, an order founded in 1841, by Marie Paul François Libermann. The organization carries on work principally among the negroes of Africa.

**HOLY-GHOST FLOWER OR DOVE-FLOWER**, a name given to a Central American orchid, *Pristeria alata*, from the fancied resemblance of the flower to a white bird with expanded wings. This resemblance causes it to be regarded as a sacred plant by the natives.

**HOLY GRAIL**. See **GRAIL**, Vol. XI, pp. 34-36.

**HOLY INNOCENTS' DAY**. See **INNOCENTS' DAY**, in these Supplements.

**HOLY LEAGUE**, a name applied to various European alliances, as that of 1511, between the Pope Julius II, Spain and Venice, against France; or that of Nuremberg in 1538, between Charles V and the Catholic princes of Germany against the League of Schmalkald. For the league of 1576 against the Huguenots, see **FRANCE**, Vol. IX, p. 562.

**HOLYOAKE, GEORGE JACOB**, an English reformer; born at Birmingham, April 13, 1817. He taught mathematics at the Mechanics' Institute in his native city; acted as secretary to the British contingent that went to the assistance of Garibaldi; was for many years editor of *The Reasoner*; was chiefly instrumental in securing the passage of the bill legalizing secular affirmations; and took a prominent part in various public movements. He was one of the leaders in the co-operation movement in England, and wrote a work entitled *The History of Co-operation* (1875-78). Holyoake was the last person imprisoned in England on a charge of atheism (1841). He was president of the Carlisle Congress of the Co-operative Societies (1887). Among his writings are *The Logic of Life* (1861); *The Trial of Theism* (1877); *Among the Americans* (1881); and *Self-Help a Hundred Years Ago* (1888).

**HOLYOKE**, a city in central Hampden County, western Massachusetts, on the Connecticut River, and on the Boston and Maine railroad. It connected is also with Springfield by an electric street-railway. It has electric lights and rail-ways, water-works, and a very beautiful granite city hall, costing nearly \$500,000. Its manufactories have a capital of \$24,000,000, and their annual products are valued at \$26,000,000. They employ, on an average, 13,140 hands, and pay in wages, annually, \$6,200,000. Of its industries, the most important is the production of fine writing-papers. Its manufactories of this are the largest in the country, employing 4,000 persons, in 26 mills. Holyoke also has the largest blank-

book works in the country. Cutlery, machinery, screws and wire are important products. It was incorporated as a city in 1873. Population 1875, 16,260; 1890, 35,637; 1900, 45,712.

**HOLYOKE, MOUNT**, a ridge in central Hampshire County, Massachusetts, consisting of greenstone trap, very narrow and steep. It separates the townships of Hadley and Amherst from South Hadley and Granby. On the northern side, in the first-named township, lies Mount Holyoke College, the oldest college for the education of women in the United States, being founded in 1837. It has 34 instructors, 335 students and a library of 16,000 volumes. The scenery surrounding the grounds is very beautiful.

**HOLY ROOD**, the cross on which Christ was crucified. See **CROSS**, Vol. VI, pp. 610, 611.

**HOLY THURSDAY**. See **HOLY WEEK**, Vol. XII, p. 106.

**HOME, DANIEL DOUGLAS**, a Scotch-American Spiritualist; born near Edinburgh, Scotland, March 20, 1833. He removed to the United States in 1840. In his youth he claimed to have had spiritualistic visions, and at 17 years of age published himself as a medium. In 1853 Home went to New York to study medicine. He finished his course, but did not practice. Later he removed to London, where he remained for several years giving spiritualistic seances, and exhibited his art in Russia, Germany, Italy and France. In 1858 he married a Russian lady of wealth and station. In 1863 Home went to Italy to study art, and in 1866 a Mrs. Lyons made over to him \$165,000 with the proviso that he should add "Lyons" to his name. Some years afterward the donor demanded the return of her gift. Home refused compliance, the case came to trial, and was decided in favor of the plaintiff. In 1871 he married another Russian lady, but the union proved unhappy. Thereafter Home retired from public view, and died insane. While in Europe Home was befriended by many of the literary and scientific men and women of the time; among them, Mrs. Browning, Mary Howitt, Alexandre Dumas, Professor Crookes and Victorien Sardou, all of whom testified to the genuineness of the phenomena he produced. Robert Browning's *Mr. Sludge, the Medium*, is supposed to be a study of Home. He died June 21, 1886, in Auteuil, France.

**HOMER**, a city of Champaign County, central Illinois, 48 miles E.S.E. of Bloomington, on the Illinois Central, the Cleveland, Cincinnati, Chicago and St. Louis and the Wabash railroads. It has a flour-mill and is a shipping-point for fruit and grain. Population 1900, 1,080.

**HOMER**, a city and the capital of Claiborne Parish, northwestern Louisiana, a terminus of the Louisiana and Northwest railroad, on the D'Arbonne Bayou. It is in a large cotton-growing district, and grapes are cultivated extensively. Population 1890, 1,132; 1900, 1,157.

**HOMER**, a village of Calhoun County, central southern Michigan, on the Michigan Central, the Lake Shore and Michigan Southern and the

Cincinnati, Jackson and Mackinaw railroads, 22 miles W. of Jackson. It is the shipping point for a large grain district, and has manufactures of flour, agricultural implements, dairy products, oil-stoves, and bath-tubs. Pop. 1900, 1,097.

HOMER, a village of Cortland Co., N. Y., on the Delaware, Lackawanna and Western railroad, 27 miles S. of Syracuse, in a farming and dairying district; has foundries, flour-mills, and factories of wire-cloth, rotary-engines, wagons, and sleighs. Population 1900, 2,381.

HOMER, WINSLOW, an American artist; born in Boston, Feb. 24, 1836;



WINSLOW HOMER.

at 18 he went to work for a lithographer in Boston; in 1859 moved to New York, and was engaged as designer for a publishing house, at the same time studying art in the evening at the Academy of Design; first won public notice by two pictures on war subjects, entitled *Home, Sweet Home*, and *The Last Goose at Yuletown*. In 1865 he was elected academician, and two years later went to Paris to study. His pictures have the qualities of originality and individuality, and won the praise both of the critics and the public. Among the best known are *Prisoners from the Front*; *Snap the Whip*; *Eating Watermelon*; *Flowers for the Teacher*; *Undertow*; *Eight Bells*, which attracted much favorable attention at the Chicago Fair in 1893; and three marines, *Northeaster*, *Stormbeaten*, and *Wood's Island by Moonlight*, which gained the medal of honor at the exhibition of the Academy of Fine Arts, Philadelphia, in 1896.

HOME RULE, a title selected by an Irish political organization as definitive of its objects, and also applied to the British Parliamentary party representing that organization. Originating among the moderate spirits of the Irish agitators in the period following the repression of the Fenian rising of 1867, and fanned by the disestablishment of the Irish Church, the movement crystallized into action on May 19, 1870, when, at a meeting of prominent Irishmen in Dublin, a resolution was adopted "that the true remedy for the evils in Ireland is the establishment of an Irish Parliament with full control over Irish domestic affairs."

An organization entitled "The Home Government Association of Ireland" was formed, and a programme or platform adopted, which, while in the main more moderate than the Fenians desired, in some respects went beyond O'Connell's demand for repeal of the Union. The Parliamentary leader selected was Isaac Butt, an Irish barrister whose pleadings for the Fenian prisoners had brought him popularity, and won for him election to the presidency of the Amnesty Association. In 1871 the new movement succeeded in seating its Parliamentary candidates for the counties of Meath, Galway and Westmeath and for

Limerick borough, in which last-named constituency Isaac Butt was returned without opposition.

The year 1872 witnessed a further accession of strength and the adoption of "Home Rule" as the watchword. In November, 1873, a national conference, held in Dublin, attended by 900 delegates, resolved to reorganize under the name of Home Rule League. The party carried 60 Irish seats in the general election of February, 1874, and soon commenced to demonstrate at Westminster that its desires constituted a condition rather than a theory, and as evidence thereof opened the session with a Home Rule amendment to the Address, the amendment being defeated by 314 votes to 50.

The next three sessions of Parliament were occupied by motions for committees to inquire into the causes of Irish discontent, which shared the fate of the amendment to the Address. Then internal dissension weakened the Home Rulers, the obstructionist or extreme wing of the party, under Major Nolan and the future leader, C. S. Parnell (q.v. in these Supplements), desiring to block all Parliamentary legislation by persistent but dexterous obstruction until Ireland's grievances received attention and relief.

The younger man prevailed. At the end of 1877 the control of the Irish Parliamentary party was in Parnell's hands, and Butt's death in 1879 marked the close of the original and strictly constitutional phase of the Home Rule question. This may be called the first period of the Home Rule agitation, one which was marked by a gradual growth of the Irish Parliamentary party from a quartet of earnest men in 1870 to a compact voting-power of 60 members in 1874. Under Butt's leadership the policy of the party was simple and efficacious. On Irish questions it voted as a unit; in other matters, each member followed the lead of the party with which he was in sympathy. The principal achievement was to draw attention to Irish affairs by an annual motion, which was as regularly voted down. With the advent to Westminster of Joseph Gillis Biggar and Charles Stewart Parnell came a change to more aggressive tactics. General and systematic obstruction in the hands of 60 determined members grew in favor, and while it cost the Irish party the support of the advanced Conservative and Whiggish-Liberal members, it attracted Irishmen the world over, and appeased the home demand for activity.

In the interim between Butt's death and Parnell's formal election as leader, Parnell's was undoubtedly the hand which held the strings of the Irish party. William Shaw, a Liberal, was for a time in nominal control, but, backed by the influence of the agrarian agitation, and, strangest of all, as a Protestant supported by the entire body of the Catholic priesthood, Parnell placed eight fresh Home Rule members in Parliament in 1880, and before May of that year had passed, was formally chosen as the leader of the Parliamentary party. The land-agitation was the co-

hesive power which made him the great leader of the Celtic and Catholic peasantry. O'Connell rose to power by agitation for Catholic relief. His successor had as popular a platform in promising relief from the evils of absenteeism, rack-renting and eviction.

Home Rule, as urged by Parnell and his supporters, was hardly distinguishable from O'Connell's repeal of the Union. The Shaw faction withdrew into opposition in 1881, disapproving the Parnellites' persistent obstruction to coercive measures. Thenceforth until 1886 the agitation was directed by a mastermind in politics, by a man who, until his moral fall, controlled the varying forces and moods of his party with the military skill of an Alexander, the patience of a Fabius, and with the silent mastertactics of a Von Moltke. To his persistence alone is to be attributed William E. Gladstone's conversion to Home Rule.

From October, 1879, dates the formation of the Irish Land League by Michael Davitt, and the commencement of widespread anti-rent agitation. The winter was severe, and distress and evictions were general and frequent. Davitt and other leaders were arrested for agitating, but soon released on bail. In Parliament, Parnell and his followers brought to perfection their policy of obstruction, being supported by no inconsiderable faction of the English and Scotch members. An Irish Universities Bill was offered as a sop to Cerberus, carried with the co-operation of Mr. Shaw and the milder spirits of the Irish party, but fell far short of the reforms demanded. The anti-rent agitation and a demand for a general reduction of rents had at least the reason of apprehended distress to support it. But little could be done amid the glamour of Beaconsfield's theatrical return from the Berlin Congress. His "Peace with honor" and "Imperium et libertas" awoke the chauvinism of 1878 and kept his party in power until March, 1880. Then Gladstone faced obstruction, with 349 Liberal members supporting him, and 243 Conservatives to oppose his plans. Sixty Home Rulers were potent in debate and obstruction, but were unable, as at a later date, to turn the ministry out of office.

The Peace Preservation Act was to be discontinued, and a Relief of Distress Act to be passed. In this last a Compensation for Disturbance Clause was passed by the Commons by 303 votes to 237, but rejected in the House of Lords by 282 votes to 51. The extreme Irish party speedily took their places on the opposition side of the House of Commons, and passed the word to "distrust the Whigs." The Land League, with whose working machinery Mr. Parnell had come to power, began to be active, and commenced to enroll the peasantry under the banner of "Hold the rent." The Compensation for Disturbance Bill was but a reopening of old sores. It satisfied no one, and irritated many. The tenants were told to hold the harvest as well as the land, and to defy all legal process for recovery of rent or premises. Agrarian outrages increased apace, and "Griffith's valuation" of nearly a century before, which was

at least 25 per cent under the letting value of ordinary land, was decided upon by the Land League as the only valuation upon which rent should be paid. The assassination of Mr. Boyd, a land agent's son, the murder of Lord Mountmorris and the shooting of Mr. Hutchin's car-driver were some of the incidents of the agitation.

The Peace Preservation Act of 1870 was allowed to expire in June, and the autumn witnessed a carnival of inexcusable crime. It was impolitic crime, also, as it still further postponed all remedial agrarian legislation, and produced merely a demand for more coercion from the English majority in Parliament.

Mr. Forster, the Chief Secretary for Ireland, had to meet an indignant body of landlords clamoring for military and police protection, and even the precincts of Palace Yard at Westminster were invaded by Rachels mourning for their children, and refusing to be comforted by anything less than a military expedition. Between the obstructive Home Rulers and an indignant country the Gladstone government had not much choice. An ill-advised information for seditious conspiracy against Mr. Parnell, several of his party and some of the officials of the Land League was applied for by the crown officials, and the great state trial which ensued ended in a fiasco by a long-expected disagreement of the jury. Ireland looked on the result as a victory, and crowned Parnell and his co-defendants as victors in the fray.

In the Cabinet all was dissension and division as regards Irish policy. While Mr. Gladstone and Mr. Forster argued for heroic measures, Chamberlain, Bright, and the Birmingham school of Liberals as loudly proclaimed that force was no remedy. In Ireland, juries refused to convict on direct and conclusive evidence, lawlessness was prevalent and prolific in murder, and all legal authority was at an end.

Intimidation was widely prevalent, and gave a new word to the English language, in the treatment of Captain Boycott, Lord Erne's agent, near Lough Mask. Police protection was powerless, and the government supine until the tenant farmers of Cavan and Monaghan organized an expedition for the relief of Lough Mask House. Then, fearing a racial and religious conflict, an army of a thousand men was sent to relieve the obnoxious agent, and the "emergency" men of Ulster, generally provided by Orange lodges, were allowed to gather in Captain Boycott's crops. But his position was little better than before. He had to leave the farm, in which he had sunk much capital; and the impossibility of keeping intimidation in check with soldiery was strikingly demonstrated. Boycotting became general, and even steamship and railroad companies came under its ban.

The government had to decide between surrender and coercion, and Mr. Forster introduced the "Protection for Life and Property Bill" in the early days of 1881. It was a stringent and coercive statute, the worst feature of which was a "suspect" clause, superseding all *habeas corpus* proceedings, and enabling a timid official to tem-



porarily imprison any person he was afraid to try before a jury. The measure was met with a determined policy of obstruction. One sitting of the House of Commons lasted 41 hours. Obstruction was rampant until an exasperated majority compelled the Speaker to end the debate and order the first reading of the obnoxious bill. The next day, 36 Irish members defied the Speaker's authority, and one by one were suspended and removed from the House. New rules of procedure were passed to meet organized obstruction, and in March, 1881, the act became law. Gladstone endeavored to placate the Irish in April, with an Irish land bill, which cost him the support of the Duke of Argyll. It was a half-hearted, tentative measure, permitting a tenant to sell his interest, and enabling him to obtain a judicial fixing of his rent at a valuation which was to be inviolable for 15 years. It passed into law while the nation was mourning for Beaconsfield. The agitation still went on, and the Land League ruled Ireland more potently than did Dublin Castle. John Dillon was the first arrested of the Home Rule members, and many of his fellow-members were sent to join him in Kilmainham jail, while the "physical force" party in America inaugurated the gospel of dynamite in the principal cities of Great Britain. It only served to nerve a weak executive to more persistent coercion.

The political situation was a grave one for the government. The extremists, catering to the demand of Transatlantic supporters, repudiated the Land Act, and called on the tenants to resist eviction and hold the rent. Nothing more than "prairie value" was to be paid for the land, and "landlordism" was to become extinct in the future. The Catholic hierarchy, Sir Charles Gavan Duffy, and other prominent Irishmen supported Gladstone in his resistance to what he termed "the gospel of public plunder."

The government struck its blow in October, and imprisoned Mr. Parnell and many of his party in Kilmainham jail. This was met by a counter-movement—the "no-rent manifesto," adjuring the tenantry to pay no rent until the victims of British despotism were released. The rejoinder of the government was the suppression of the Land League on October 20th, as "an illegal and criminal association, intent on destroying the obligation of contracts and subverting law." Outbreaks of lawlessness and rioting in Dublin, Limerick and other places were suppressed, and a visible reaction against the "no-rent manifesto" began to develop. The action of Archbishop Croke, hitherto one of the principal supporters of the Land League, in condemning the refusal of rents, did much to smooth the path of the executive. The Land Commission commenced its sessions and adjudicated some 50,000 applications for reduction of rent. Ulster accepted the Land Act all but universally, and the severe reductions of rent, by the subcommissioners, filled the hearts of the tenantry with hope and carried dismay into the ranks of landlordism. But coercion was pres-

ent in prosecutions and arrests under the suspect clause, and police and soldiery were freely employed in aid of evictions. The widespread refusal of rents, however, produced much genuine distress among the Irish landlords, and, evoking sympathy in England, caused a Mansion House fund to be started in England for their relief.

The year 1882 opened peacefully, but it was the stillness before the storm. Parnell and many of his supporters were in Kilmainham jail; coercion was rigidly administered by Chief Secretary Forster, a sturdy Quaker of the old Puritan stripe; the harvest had been plentiful, and there was no distress. The spring brought a renewal of agrarian murders, and the actions of juries were unsatisfactory and opposed to evidence. Then the radical element in the Liberal councils prevailed, and Captain O'Shea negotiated the so-called "Kilmainham treaty," whereby, in return for the release of the imprisoned suspects, the cooperation of the Home Rulers was to be given to the pacification of Ireland. Forster, disgusted with a treaty with treason, resigned from the Cabinet, and his warnings were fully justified by the assassination of his successor, Lord Frederick Cavendish, and Under-Secretary Burke, in broad daylight, within Phoenix Park, and in sight of the viceregal lodge. For a time the assassins escaped. England was moved to the core, and Ireland recoiled from the inhumanity meted out to one who bore the olive branch of peace. Connaught soon imitated the example of Dublin; Mr. Bourke and a soldier escort, and Mr. Blake, Lord Clanricarde's agent, and his steward, were ambushed and shot to death. Assassination stalked in the footsteps of outrage, and provoked the most stringent of coercion acts, with the exception of Lord Grey's act. G. O. Trevelyan became Chief Secretary, the police were reinforced by patrols of marines, and convictions in the Maamtrasna and Lough Mask murder cases did much to inspire respect for the law.

The year saw the inauguration of the Irish National League, an active political organization founded in succession to the Land League, after the suppression of the latter by the British government. It was both political and agrarian in character, its main objects being the reform of the land laws, the weakening of the power of the landlords, the increase of peasant proprietors, and the creation of an independent or semi-independent government for Ireland, under the name of Home Rule. There were soon about two thousand branches of the league scattered throughout Ireland, each with its president, secretary and treasurer. In America there was an organization of a similar character, and another in England. Scotland, also, had a league, composed principally of Irishmen, which advocated the principles of the parent institution north of the Tweed.

A conflict of opinion between Parnell and Davitt showed that the former was the leader of the party, and shelved the more violent measures conceived by his more open and adventurous follower.

The year 1883 commenced with an era of comparative peace in Ireland. A revival of an antique method of legal procedure, in requiring sureties for good behavior of all prominent agitators, consigned Healy and Davitt, with many others, to temporary imprisonment. The invincibles, assassins of Lord Frederick Cavendish, were arrested, and five suffered the extreme penalty of the law, mainly on the evidence of the informer, James Carey, who, if possible, was more blood-guilty than they. The informer met the usual fate, at the hands of an Irish-American named O'Donnell. Again the physical force party in America tried the policy of dynamite. Ulster rallied to repel the separatists, and Parnell received a national tribute of £38,000.

The year 1884 found Parliament so occupied with the Franchise and Redistribution Bills that Ireland's grievances obtained little attention. More dynamite outrages occurred, only two of many perpetrators being brought to justice. Explosions in the Tower of London and at the House of Commons occurred in the early days of 1885. The possibilities of the Franchise Bill enabled Parnell to formulate his policy for the future. The absolute minimum of Irish demand was to be the restoration of Grattan's Parliament, but, as he significantly declared, "we have never attempted to fix the *ne plus ultra* of Ireland's nationhood, and we never shall." But the nearer reform came, the more fierce was the opposition to coercion. There were other forces besides the Home Rulers opposed to exceptional legislation. Gladstone was defeated on a budget proposal, and Lord Salisbury came to power, prepared to rule Ireland with the iron hand of coercion unless agrarian crime ceased. Lord Ashbourne's Land-Purchase Act passed, and the general election restored Gladstone to power in the early days of the following year.

More than memorable was the year 1886, marking, as it did, the conversion of W. E. Gladstone to the principles of Home Rule and the parting of the ways between the influential and patriotic Whigs on the one side and the followers of the "old Parliamentary hand" on the other. In April, Gladstone introduced his first Home Rule Bill.

The following were some among its chief provisions:

An Irish legislature to sit in Dublin, with the Queen as its head, to consist of 309 members, 103 in the first order (with property-qualification, and elected on £25 franchise), and 206 in the second order, the two orders to sit together, and, unless a separate vote is demanded, to vote together; if the two orders disagree, the matter to be vetoed for three years; if then carried by the second order, it was to be decided by a majority of both orders. The Lord-Lieutenant to be appointed by the crown, not as the representative of a party; his office not to be altered by the Irish legislature; he can assent to or veto any bill. The executive to be constituted as in England. All constitutional difficulties to be settled by the privy council, whose decision was to be final. The prerogatives of the crown to be untouched. All matters concerning peace or war, foreign and colonial relations, trade, navigation, post and telegraphs, coinage, army, navy and reserve forces to remain in the hands of the imperial Parliament. The Irish legislature not to establish or endow any religion, or to prohibit religious freedom. The customs and excise to

be levied by the British treasury. The rights of existing civil servants, judges, and other permanent officials and police to be safeguarded. The Irish legislature to raise and pay a police force. The Irish members not to sit at Westminster, except when summoned back for special purposes. This act not to be altered unless they are so summoned back (28 to the Lords, 103 to the Commons). Ireland to pay one fifteenth as her portion of interest on national debt, of army and navy and civil service charges, and £1,000,000 toward present Irish constabulary till superseded.

Imposing was the array against the bill. The heads of the great Whig houses—the Grosvenors, the Russells, the Cavendishes, the Greys, the Fitzwilliams—declared against the "disruption of the empire and the surrender of property to the apostles of public plunder." The statesmen were, to a man, against the measure. Lord Hartington, Lord Selborne, the Duke of Argyll, Lord Derby, Lord Northbrook, John Bright, Mr. Goschen, Sir Henry James, Mr. Chamberlain and Mr. Trevelyan turned from the ranks of the leader whom they had followed for years. The Liberal scientists, jurists and men of letters rallied to the defense of the empire, and numbered among them Lord Tennyson, Lord Wolsley, Lord Bramwell, Sir James Stephen, Matthew Arnold, Goldwin Smith, James A. Froude, W. E. H. Lecky, Professor Huxley, Professor Tyndall, Sir Frederick Leighton, Swinburne the poet, the Rothschilds and the Barings. In a word, every representative Liberal was found on the Unionist side.

The second reading of the measure was lost, June 7, 1886, by a vote of 341 to 311, no less than 93 Liberals voting in the majority. Every available method was used to increase the majority, and undoubted was the effect of the publication of the productions of Richard Pigott's facile pen. "Parnellism and Crime," as it ran day after day in the columns of the *Times*, was an engine of rare power wherewith to frighten doubtful members, and the silence of the Irish members lent force to the attack. The session ended, and Gladstone appealed to the country. The verdict was adverse, and the new Parliament held 316 Conservatives and 78 Liberal-Unionists, as opposed to 191 Home Rule or Gladstonian Liberals and 85 Irish Home Rulers. With Lord Randolph Churchill as leader of the House of Commons, a start was made with that twenty years' policy of resolute government outlined by Lord Salisbury, and reviled by the Gladstonians as a policy of "Manacles or Manitoba."

Parnell's Tenants' Relief Bill was rejected, and the "Plan of Campaign" was published in *United Ireland*, October 23, 1886. It was a system of procedure propounded by William O'Brien, and supported by the Land League. It was a recommendation to Irish tenants not to pay rent to landlords, but to pay officials representing the League what was deemed a fair rent, which would be handed over to the landlords, provided the latter accepted it as a payment in full. If refused, the money was to be used for the support of evicted tenants. The "Plan" was not long in being put in operation, and proved so embarrassing that the government proclaimed it as illegal.

In spite of this, however, it was long subsequently in operation in remote districts.

Early in the year 1887 an attempt was made, by means of the Round-Table Conference, to win back the Unionist Liberals to the Gladstonian fold. But the breach was too wide to bridge. In July came the passage of an Irish Land Bill, the proclamation of 18 counties under the Crimes Act, and with August and September the proclamation of the Land League, the Mitchelstown riot, which gave an exasperating party-cry to the Home Rulers. Gladstone's American admirers now presented him with a silver centerpiece in recognition of his efforts to secure Home Rule. In October occurred the semi-ludicrous incident of the struggle over Mr. O'Brien's clothing, and in December several Irish members of Parliament felt the force of the Crimes Act.

Little marked the opening of 1888, until a conflict between the police and the Nationalists occurred at Loughrea, in April, but June saw the ordering of a special commission of Parliament on the charges made in *The Times* articles on "Parnellism and Crime." The commission met for the first time, Sept. 17, 1888, and made such progress that on Feb. 27, 1889, the forgeries by Pigott were confessed, and *The Times* had withdrawn the charges made. Pigott, a fugitive in Madrid, committed suicide to avoid arrest on March 1st of the same year. When the commission finally presented its report in 1890, it practically found the Irish members guilty of handling pitch and playing with fire. Their association with and verbal approval of the acts of criminals formed the gravamen of the commission's findings.

Mr. Balfour's Land-Purchase Bill was introduced, as well as a Light Railroads Act, and John Dillon and O'Brien tried to force the Plan of the Campaign on the Ponsonby estate, in Tipperary. "New Tipperary" was built, and in its shanties the self-imposed martyrs waited for Gladstone's victory. In the middle of November came the exposure of the O'Shea divorce case. A long course of low intrigue, diversified by disguises, *aliases* and fire-escape flights was laid bare. The liaison had long been known to the English police, but was a revelation to many a Home Ruler. A majority of the Irish Parliamentary party refused to follow Parnell's rule, and elected Justin McCarthy as their sessional chairman. Ireland became the scene of a series of faction fights, in which vituperation contended with violence. The contending factions warred together in 1891. It was amusement for the contestants and spectators, but it was death for their cause. The priests, to a man, opposed Parnell, and by October had defeated his candidates everywhere in Ireland. In the midst of the turmoil Parnell died at Brighton, in the arms of the woman for whom he had sacrificed the brightest of Parliamentary careers, and whom he had married after the divorce decree was made absolute.

The year 1892 witnesses the amnesty debates

as regards the convicted dynamitards, and the introduction of an Irish Local Government Bill, which was spurned as a sham by the Nationalists. It was carried to a second reading by 339 to 247, but soon after was dropped. Mass meetings preceded the general election, which resulted in a Gladstonian majority of 40. Mr. Gladstone formed his fourth Cabinet at the age of 83, and nothing but the House of Lords stood in the way of Home Rule.

The expected measure was introduced. The second Home Rule Bill was introduced in the House of Commons, Feb. 13, 1893, by Mr. Gladstone, in perhaps the greatest speech that he ever made in all his sixty years of Parliamentary service. The interest centered not so much in the provisions of the bill, for in the seven years since the introduction of the bill of 1886 the English people had become accustomed to the idea of Home Rule for Ireland, as in the fact that a man of 84 made a speech of two hours' duration.

The bill which he outlined was recognized to be a great improvement on that of 1886. Then Home Rule was linked with a scheme of \$1,000,000,000 to buy out Irish landlords; in the new bill there was no hint of a penny for such a purpose. Then there was a fantastic plan of a big upper house with two orders, with Irish peers playing a dominant part; in the new bill there was a compact senate of only 48, all elective, and peers dropped out without a word of mention. The lower house, too, was cut down from an unwieldy body to 103, or 25 less than the New York state legislature.

The object of the bill remained, as in 1886, to establish a legislative body in Dublin for the conduct of both legislation and administration in Irish, as distinct from imperial, affairs. The bill, in detail, provided for a legislature for Ireland, consisting of the Queen and of two houses—the legislative council and the legislative assembly. This legislature, with certain restrictions, was authorized to make laws for the peace, order and good government of Ireland in respect of matters exclusively relating to Ireland, or some part thereof. The bill provided that the powers of the Irish legislature should not extend to the making of any law respecting the establishment or endowment of religion or prohibiting the free exercise thereof, or imposing any disability or conferring any privilege on account of religious belief, or whereby any person might be deprived of life, liberty or property without due process of law, or whereby private property might be taken without just compensation.

According to the bill, the executive power in Ireland continued vested in her Majesty the Queen, and the Lord-Lieutenant, on behalf of her Majesty, was to exercise any prerogatives or other executive power of the Queen the exercise of which might be delegated to him by her Majesty, and should, in the Queen's name, summon, prorogue and dissolve the legislature. An executive committee of the privy council of Ireland was provided for, which "should aid and advise in the government of Ireland." The Lord-Lieutenant, with the advice and consent of the executive council, was authorized to give or withhold the assent of her Majesty to bills passed by the houses of the legislature.

The legislative council, by the terms of the bill, consisted of 48 councilors. Every man was entitled to vote for a councilor who owned or occupied any land or tenement of a ratable value of twenty pounds. The term of office of the councilors was to be for eight years, which was not to be affected by dissolution, but one half of the councilors retired in every fourth year, and their seats were to be filled by a new election. The legislative

assembly was to consist of 103 members, returned by the Parliamentary constituencies existing in Ireland. This assembly, unless sooner dissolved, might exist for five years. The bill also provided for eighty Irish members in the House of Commons.

In regard to finance, the bill provided that, for the purposes of this act, the public revenue should be divided into general revenue and special revenue, and general revenue should consist of the gross revenue collected in Ireland from taxes; the portion due to Ireland of the hereditary revenues of the crown which was to be managed by the commissioners of woods, an annual sum for the customs and excise duties collected in Great Britain on articles consumed in Ireland; provided, that an annual sum of the customs and excise duties collected in Ireland on articles consumed in Great Britain should be deducted from the revenue collected in Ireland and treated as revenue collected in Great Britain; these annual sums to be determined by a committee appointed jointly by the Irish government and the imperial Treasury. It also provided that one third of the general revenue of Ireland, and also that portion of any imperial miscellaneous revenue to which Ireland might claim to be entitled, should be paid into the Treasury of the United Kingdom as the contribution of Ireland to imperial liabilities and expenditures; this plan to continue for a term of six years, at the end of which time a new scheme of tax-division should be devised.

The legislature, in order to meet expenses of the public service, was authorized to impose taxes other than those then existing in Ireland. Ireland should also have charged up against her, and be compelled to pay out of her own treasury, all salaries and pensions of judges and liabilities of all kinds which Great Britain had assumed for her benefit. The bill further provided that appeal from courts in Ireland to the House of Lords should cease, and that all persons having the right of appeal should have a like right to appeal to the Queen in council.

The term of office of the Lord-Lieutenant was fixed at six years. Ultimately the Royal Irish Constabulary should cease to exist, and no force other than the ordinary civil police should be formed. The Irish legislature should be summoned to meet on the first Tuesday in September, 1894, and the first election for members should be held at such time before that day as might be fixed by her Majesty in council.

The bill passed the Commons, September 1st, by a vote of 301 to 267, but failed in the Lords, September 8th, by a vote of 41 to 419.

Home Rule was dead thenceforth, until England, "the predominant partner," should reverse her judgment. The Irish party had their revenge in 1895, when, in a solid phalanx, they voted down a proposition to erect a statue to Oliver Cromwell. John Morley introduced a bill to carry out the recommendations of a committee on the land question to the effect that the term for which the rent was fixed (by statute) should be reduced from 15 to 10 years. The bill, however, on approaching the second reading, was dropped. In the general election of 1895, 70 anti-Parnellites and 12 Parnellites were part of the Liberal minority of 259, as against 411 Unionist members. The "predominant partner," however much disposed to local self-government, was firmer than ever against separation or Home Rule.

In February, 1896, John Dillon succeeded Justin McCarthy as the chairman of the party, and a national convention held in Dublin in September was more remarkable for violent internal dissensions than for actual results.

Considered as a theoretical political question,

the future of Irish government is a question beset with difficulties and conflicting theories.

Naturally, the bibliography of so far-reaching a subject is extensive as well as remarkable. A few of the more important and most recent works can alone be specified. They include,—

*The Speaker's Handbook on the Irish Question; The Handbook of Home Rule; T. P. O'Connor, The Parnell Movement; A. M. Sullivan, New Ireland; Prof. A. V. Dicey, England's Case Against Home Rule; Justin McCarthy, The Case for Home Rule; R. B. O'Brien, Irish Wrongs and English Remedies; Joseph Chamberlain, Home Rule and the Irish Question; Ireland's Disease, translation from the French of Philippe Daryll; H. W. Hurlbut, Ireland Under Coercion; Dr. T. Dunbar Ingram, History of Legislative Union Between Great Britain and Ireland and Two Chapters of Irish History; W. E. Gladstone, Special Aspects of the Irish Question; Sir Frederick Pollock, Home Rule and Imperial Sovereignty; Clifford Lloyd, Ireland Under the Land League; Sir Charles Russell, New Views on Ireland; Duke of Argyll, Irish Nationalism; William O'Brien, Irish Ideas; Sir Henry James, The Work of the Irish Leagues; etc.*

HOMESTEAD, a borough of Allegheny County, western Pennsylvania, on the Monongahela river, seven miles above Pittsburg, on the Pennsylvania railroad. It is the center of extensive iron, steel, and glass industries. The steel-works of Andrew Carnegie are situated here, where, from the 5th to the 10th of July, 1892, there occurred one of the most serious labor disturbances ever known in the United States, 3,421 men employed in the mills striking against a decrease in wages; and the attempt to fill their places with non-union men was followed by bloodshed and riot, and the whole organized militia of the state was called out to suppress the disorder. Some twenty men were killed during the disturbances, but the strike was not declared off until the 20th of November. Population 1890, 7,911; 1897, about 9,000. See also PINKERTON LAWS, in these Supplements.

HOMESTEAD LAWS. See HOMESTEAD, Vol. XII, pp. 122-24; and also EXEMPTION LAWS, in these Supplements.

HOMILETICS. See HOMILY, Vol. XII, pp. 125-26.

HOMINIDÆ. See MAMMALIA, Vol. XV, pp. 444-446.

HOMOPTERA. See *Hemiptera*, under INSECTS, ol. XIII, p. 153.

HOMOSPORY, a botanical term indicating that the sporophyte produces but one kind of spore. All the lower plants are homosporous, as distinguished from certain fern-plants and all seed-plants, which are *heterosporous*.

HOMS, a Syrian town. See HEMS, Vol. XI, p. 649.

HONAN, PROVINCE OF. See CHINA, Vol. V, pp. 634, 635.

HONDT FAMILY, a family of Flemish artists and engravers. JOSSE, born at Wackene, Flanders, in 1546; died in London in 1610; map-engraver. He lived most of his life in England, to escape religious persecution.—HANS (the elder), born at Ghent in 1573; died at The Hague in 1610; son of Josse; painter of portraits of Wycliffe, Savonarola, Calvin, Melancthon, Knox and others.—HENRY (the younger), born in London in 1581; died in Amster-

dam in 1650. He painted the portraits of William of Orange and Queen Elizabeth of England.—ABRAHAM, animal-painter, was born at Rotterdam in 1638, and died in London in 1691.

HONDURAS, BRITISH, a crown colony on the Caribbean Sea, south of Yucatan, and 660 miles W. from Jamaica. For general description and history, see Vol. XII, pp. 132-134.

Area, 7,562 square miles. Population 1897, 34,277. Capital, Belize, with a population of 6,972. Schools, 46; pupils, 3,693; government grant, \$14,162. Detachments of the Second West India Regiment are stationed in the colony.

Imports in 1897, \$1,422,097; exports to Great Britain, \$769,867; revenue, \$314,017; expenditure, \$322,990.

The chief sources of revenue are customs duties, excise, licenses, land tax, etc., and the sale and letting of crown lands. The expenditures are mainly administrative and for the various services. Debt (1896), \$168,815.

In 1897, mahogany exported, 6,777,382 superficial feet; logwood, 20,018 tons; fruit (chiefly to New Orleans), \$125,000; sugar, 953 tons. The transit trade greatly increases the traffic of the ports, especially in india-rubber, sarsaparilla, coffee, etc.

In 1897, tonnage of vessels entered and cleared, 390,333.

Number of letters, newspapers, etc., passed through the post office, 1894, was about 120,000, about 80 per cent being international and 20 per cent inland.

United States gold was adopted as the standard of currency, Oct. 15, 1894.

HONDURAS, GULF OF, an inlet of the Caribbean Sea, between British Honduras, Guatemala, and the Republic of Honduras. It has a great many islands and reefs, particularly along its western shore.

HONDURAS, THE REPUBLIC OF, was established Jan. 11, 1839, before the dissolution of the Confederation of Central America in 1839. (For general description and history, see Vol. XII, pp. 129-32.) It is governed under a charter proclaimed in October, 1894. This gives the legislative power to a congress of deputies in the ratio of one to each 10,000 inhabitants. The executive authority rests with a President, nominated and elected by popular vote for four years. Area, about 43,000 square miles. Population 1897, 398,877, mainly of aboriginal Indians, but with a small proportion descended from Europeans, mostly Spanish. The capital is Tegucigalpa, with about 14,000 inhabitants.

The finances of the country are in great disorder, owing to prolonged civil strife, aggravated by wars with Guatemala and San Salvador. The revenue for 1895-96 was \$1,901,606; the expenditure, \$2,264,586. The foreign debt of Honduras consists of English loans of over \$16,000,000 and a French loan of \$11,000,000, or a total of \$27,000,000. No interest has been paid since 1872, and its accumulation has reached the amount of over \$59,000,000. The finances of Honduras have become further complicated by a bloody revolution in the summer of 1892. In 1896-97 the imports amounted to \$3,260,575, and the exports to \$2,647,248. In 1897 there were 237 post offices, 2,734 miles of telegraphs; and there is a railway from Puerto Cortés to La Pimienta (57 miles), and an interoceanic railway is projected from Puerto Cortés to Amapala, on the Pacific; also a line from Puerto Cortés by the north coast, through one of the best fruit districts of the republic.

The chief products of the country are bananas, tobacco, sugar, coffee, and maize. The mineral resources are great; gold, silver, copper, lead, and coal are found. There are 17 important mining companies at work. The annual value of the gold product is about \$200,000. Since Nov., 1894, the standard of currency has been the United States gold dollar.

On the 20th of June, 1895, a treaty between Honduras, Nicaragua and Salvador was signed, which provided for the temporary union of the three republics under the name of the Greater Republic of Central America, pending a union of all the Central American republics under the name of the Republic of Central America, which should be effected, if possible, within three years. The autonomy of each country in its local affairs was to be left undisturbed. Difficulties arose, however, when the attempt was made to put the scheme into operation, and in Nov., 1898, the union was declared dissolved.

HONEYE FALLS, a village of Monroe County, northwestern New York, on the New York Central and Hudson River railroad, 15 miles S. of Rochester, on Honey Creek. The factories produce woolen goods, flour, farming-implements, strawboard, sashes, doors and blinds. The surrounding farms produce principally grain, fruit, potatoes and beans. Population 1890, 1,128; 1900, 1,175.

HONESDALE, an agricultural and manufacturing borough, and the capital of Wayne County, northwestern Pennsylvania, 23 miles N.E. of Scranton, on the Lackawaxen River, and on the Delaware and Hudson, and the New York, Lake Erie and Western railroads; also on the Delaware and Hudson canal. It manufactures green, cut, engraved and decorated glassware, silk and woolen goods, boots and shoes, canal-boats, electric elevators, axles, castings, emery and polishing wheels, and clothing. It is also a coal-depot, shipping annually two million tons. The first locomotive used in America made its trial trip from Honesdale on Aug. 8, 1829. The place is supplied with city water, electric and gas lights, and has a public library. Population 1900, 2,864. The surrounding country is well populated.

HONEY-ANT, a hymenopterous insect of the genus *Myrmecocystus*, common in the Southwestern states and in Mexico. Certain members of a colony store up honey in the abdomen during the summer. These individuals lose much of their activity, and food is regularly brought to them by the workers. In times of scarcity these fattened ants supply the others with food. Some naturalists assert that the honey is regurgitated; others state that the honey-bearers are devoured. The honey-bearers are modified workers, not a special caste. They are often dug up by the natives, and from them an agreeable drink is prepared. See HONEY, Vol. XII, p. 136.

HONEY-BUZZARD OR BEE-KITE (*Pernis apivorus*), a bird of the falcon family, found in many parts of Europe. The bird is insectivorous, seeking chiefly the larvæ of hymenopterous insects, such as bees and wasps. The nests of these are plundered by the bird, in search of larvæ, and sometimes the honey is said to be extracted from the cells. Another species is peculiar to Asia.

HONEYCOMB-MOTH OR BEE-MOTH, the popular name of two species of moths belonging to the genus *Galleria*. These insects live in the nests of bees, and they are especially common in the hives occupied by domesticated bees. The eggs are deposited in the honeycomb. The caterpillars destroy the comb by eating and by constructing in it long silk lined galleries. The caterpillar is cream-colored,

with brown head. The moth has gray fore wings, streaked with purplish brown. Two broods a year are developed, and winter is passed in the pupa state.

**HONEYDEW**, a viscid, saccharine exudation, often found in warm, dry weather on the leaves and stems of trees and herbaceous plants. Often, but not always, it is associated with the presence of insects which feed on the juices of plants, and its flow is ascribed to their punctures, but the rupture of the tissues from any other cause seems also to produce it, and warm, dry weather seems to produce in the sap that superabundance of sugar which is thus thrown off. Aphides themselves exude a fluid called honeydew, which probably differs considerably from the direct exudation of the plant, but mingles with it where they abound. Different kinds of manna are the dried honeydew of certain plants. But, generally, this exudation as it dries coats the surface of leaves and branches with a clammy film, on which molds and other small fungi soon grow, and thus the pores of the plant are clogged and its health is impaired. Gardeners are therefore careful to wash off honeydew. Orange and lemon plantations sometimes suffer great injury from the abundance of honeydew, as do the coffee-plantations of Ceylon.

**HONEY GROVE**, a city of Fannin County, northeastern Texas, on the Texas and Pacific railroad, 40 miles E. of Sherman. It is surrounded by farm and stock lands, and building-stone is quarried near here. It has flour and grist mills, a cotton-compress and gins. Population 1900, 1,483.

**HONEY-LOCUST**, a name given to species of the leguminous genus *Gleditschia*, notably *G. triacanthos*, which is a rather tall tree, with compound pinnate leaves and usually large compound thorns. The pods are linear and flat, often twisted or curved, and contain a sweetish pulp about the seeds.

**HONEY-SUCKER**. See **HONEY-EATER**, Vol. XII, p. 139.

**HONGKONG**, a crown colony of Great Britain, formerly a part of China. (See Vol. XII, pp. 141-42.) It is the great center for British commerce with China, and a military post of first importance. By the convention of June 9, 1898, China leased to Great Britain, for 99 years, a portion of the mainland opposite to the island of Hongkong, and the area of the colony is now about 400 sq. miles. The population of the former colony was, in 1891, 221,441, of whom 210,995 were Chinese; in 1898 it was about 248,710, of whom 13,700 were British and foreign. The population of the newly leased area is about 100,000 additional. The governor has a salary of \$32,000. In 1897 there were 109 schools (subject to government supervision), with 6,787 pupils, expenditure \$66,214; also private schools, with 2,000 pupils. In 1897 the revenue was \$3,352,366, the expenditure \$2,513,693. There is an imperial garrison of 2,800 men. Hongkong is the headquarters of the China squadron, numbering 34 vessels in 1898. In 1897 4,974 vessels, of 6,063,640 tons, entered the port.

**HONOLULU**, the capital of the Hawaiian or Sandwich Islands, on the southern coast of the island of Oahu, lat. 21° 18' N., long. 157° 55' W.

It is beautifully situated and has a salubrious climate, the temperature ranging from 60° to 87° F. Its most interesting public buildings are the Palace, the Parliament buildings, the Roman Catholic Cathedral and the Bishop Museum. It has a public library, and is supplied with city water, electric lights and a telephone system. It is the seat of government and the commercial center of the islands; but it was not originally the capital, and its importance is of modern growth, being due to the fact that its harbor is the only really well-protected port in the archipelago. Steamers between San Francisco and Vancouver and Australia touch here regularly. Pop. 1900, 39,306. See HAWAII, in these Supplements.

**HONORS OF WAR**, certain privileges granted to a garrison when surrendering, either by the generosity of the conquering general or by stipulated agreement in the terms of capitulation. It is evident, therefore, that the degree of such honors may be varied indefinitely, according to circumstances. The highest honor that can be paid to an enemy is to allow them to march away with their arms, and with drums beating and colors flying. In other cases they are permitted to march out of their lines, either silently or not, and deposit arms, colors, etc., in a stipulated place, and then either march back as prisoners of war or to their own territory, after having given their parole not to take up arms again. Of the latter sort were the terms given the Confederate army at the surrender at Appomattox Courthouse, April 9, 1865.

**HONVÉD**, the Hungarian militia. The term (meaning land-defenders) was first used in the early history of Hungary to denote the national champions. It was revived in 1848 and applied to the army that fought against the Slavonic nations in the south, and when the war broke out with Austria, to the entire Magyar army. After the close of the revolution, upon the formation of the Austro-Hungarian monarchy, the Hungarian militia was called the Honvéd, out of feeling for national prejudice. In organizing the Honvéd the principle of universal military duty is applied. Active service for two years is required, then ten years' service in the reserve. On a war-footing the Honvéd numbers two hundred thousand.

**HOOD**, ALEXANDER, an English admiral; born in 1827, near Axminster; entered the service under the patronage of Admiral Smith; made lieutenant in 1746; in 1756 was given command of the *Prince George*; became admiral in 1782, and viscount in 1800; died May 3, 1814. During the War of Independence in America, he commanded under Kappel, Rodney and Howe, and in 1794-95, in the channel and at Gibraltar, gaining a victory over a French fleet in the latter year.

**HOOD**, JOHN BELL, an American soldier; born at Owingsville, Kentucky, June 1, 1831; graduated at West Point in 1853, and served against the Indians. When the Civil War broke out, he entered the Confederate army as lieutenant, and finally rose to the rank of lieutenant-general, with the command of an army. He served throughout the Virginia campaign and was wounded at Gaines's Mill, at Gettysburg, and at Chickamauga, where he lost a

leg. He commanded a corps under Gen. J. E. Johnston in the retreat to Atlanta, and in July, 1864, succeeded him in command of the army. On September 1st he was compelled to evacuate the city and leave the road free for Sherman's march to the sea. He yet made a bold attempt to cut Sherman's communications, and though worsted at Franklin on November 30th, pushed as far north as Nashville, but here he was defeated again by Thomas on December 16th, and at his own request he was



GENERAL JOHN B. HOOD.

relieved of command. His personal experiences were published posthumously as *Advance and Retreat* (1880). He died in New Orleans, Aug. 30, 1879.

**HOODED SEAL** (*Cystophora cristata*), a seal, often called bladder-nose, sometimes taken at Newfoundland and on the northern coasts of Europe, but nowhere abundant. In the male the skin of the nose can be inflated into a crest or hood, hence the name. The color is black above, lighter on sides and on the ventral surface. The male sometimes reaches a length of eight feet, and a weight of 800 pounds. The animal is valuable for its skin and oil. See SEAL, Vol. XXI, p. 581.

**HOOGLY**, a part of the river Ganges known as BHAGIRATHI; q.v., in these Supplements.

**HOOF**. See HORSE, Vol. XII, pp. 178, 195.

**HOOK, JAMES CLARKE**, an English painter; born in London, Nov. 21, 1819. He became a student at the Royal Academy in 1836; went to Italy to study in 1846; was elected to the Royal Academy in 1860. At first he painted religious or romantic subjects, but afterward turned his attention almost exclusively to marine pictures. Among his early works are *Ris-pah*, which won him a traveling-scholarship in 1846; *Luff-Boy*; *Gathering Eggs*. Among his later ones, *The Sapphire-Gatherer* (1875); *Seaside Ducks* (1877); *Friends in Rough Weather* (1878).

**HOOKAH** (a smoking-pipe). See PIPE, Vol. XIX, p. 111.

**HOOKER, SIR JOSEPH DALTON**, an English botanist, son of Sir W. J. Hooker (1785-1865), was born at Halesworth, in Suffolk, June 30, 1817; educated at the High School and University of Glasgow, graduating M.D. in 1839. He soon afterward joined the Antarctic expedition of the *Erebus* and *Terror*, upon which he gathered material for his *Botany of the Antarctic Voyage* (6 vols., 1847-60). Returning after four years' absence, he acted for some time as substitute for Professor Graham in the chair of botany at Edinburgh University; in 1846 was appointed botanist to the Geological Survey of Great Britain, and in the following year undertook a botanical expedition to the Himalayas, which lasted three years. In 1871 he made an expedition to Morocco, ascending the great Atlas, the summit of which had never before been reached by a European. In 1877 he accompanied Dr. Asa Gray in a scientific

tour through Colorado, Utah and California. On his return he presented to Kew a large collection of seeds and museum specimens, and a herbarium of about a thousand species, together with notes on the distribution of North American trees. He published *Himalayan Journals* (2 vols., 1854); *Genera Plantarum* (1862-83); *Students' Flora of the British Islands* (1870); *Tour in Morocco* (1878). He was president of the Royal Society from 1873 to 1878, director of Kew Gardens from 1865 to 1885.

**HOOKER, THOMAS**, an American colonial settler, one of the founders of Connecticut; born at Markfield, Leicestershire, in 1586; studied at Cambridge; became a fellow of Emmanuel College, and was for four years a curate at Chelmsford. Ejected for nonconformity in 1630, he lived in Holland until 1633, when he went to Massachusetts, and received a charge at Cambridge. In 1636 he removed with his congregation to Connecticut, and founded the town of Hartford, where he died, July 7, 1647.

**HOOK-SQUID**, a popular name for cephalopod mollusks of the family *Onychoteuthidae*, which have long tentacles armed with hooks and sometimes with suckers. The name is especially given to the genus *Onychoteuthia*. The tentacles of this animal have enlarged tips with recurved hooks, and suckers at the base of the hooks. In the related genus *Eupleuteuthia* the suckers are wanting. These squids are found in most seas, warm and cold. Some individuals attain a length of six feet.

**HOOPER, SAMUEL**, an American merchant; born at Marblehead, Massachusetts, Feb. 3, 1808. After receiving a common-school education he entered the counting-house of his father, a West India merchant. In 1832 became a partner in the firm of Bryant, Sturgis and Company, Boston; in 1842 a member of the firm of William Appleton and Company; elected to the Massachusetts house of representatives in 1851; in 1857 to the state senate; in 1860 to Congress, being re-elected at every election thereafter until his death. In 1866 he gave Harvard College \$50,000 with which to found a school of mines. He died in Washington, District of Columbia, Feb. 13, 1875.

**HOOPER, WILLIAM**, a signer of the Declaration of Independence; born in Boston, June 17, 1742. Graduated at Harvard; studied law, and in 1767 settled in Wilmington, North Carolina; elected to the Continental Congress of 1774; re-elected in 1775, and at the expiration of his term, serving until 1777. He died at Hillsboro, North Carolina, October, 1790.

**HOPESTON**, a village of Vermilion County, eastern Illinois, on the Chicago and Eastern Illinois and the Lake Erie and Western railroads, 98 miles S. of Chicago. It has grain-elevators, brick and tile works, corn-canning, clothing and carriage factories, and considerable traffic in grain and hay. It is the seat of Greer College. Population 1890, 1,911; 1900, 3,823.

**HOOSAC RIVER**, a stream of eastern New York, which rises in Lanesboro township, Berkshire County, Massachusetts, flows north for about twenty miles, then turns northwest and flows through the

southwest corner of Vermont into New York, where it is known as the Hoosick. It enters the Hudson in the northern part of Rensselaer County, 14 miles above Troy. It affords abundant water-power, which is extensively utilized.

HOOSICK FALLS, a village of Rensselaer County, central eastern New York, 26 miles N.E. of Troy, on the Hoosick River, and on the Fitchburg railroad. It has manufactories of lumber, mowing machines, farming tools, saw and knitting mills and malleable iron-works. Population 1900, 5,671.

HOPE, a post village and railroad junction of Hempstead County, southwestern Arkansas, 112 miles S.W. of Little Rock, on the St. Louis, Iron Mountain and Southern and the Arkansas and Louisiana railroads. It has lumber and planing mills and a sewing-machine factory. It is an important shipping-point for cotton, lumber and hides. Population 1890, 1,937; 1900, 1,644.

HOPE, ALEXANDER JAMES BERESFORD, an English statesman and author; born in London, Jan. 25, 1820. Educated at Harrow and Cambridge; member of Parliament for Maidstone from 1841 to 1852, and again in 1857; for Stoke-upon-Trent in 1855; for Cambridge in 1868, and until his death. He took an active part in promoting artistic church architecture. He published *Letters on Church Matters* (1851); *The English Cathedral of the Nineteenth Century* (1861); and the novels *Strictly Tied Up* (1880) and *The Brandreths* (1882). During the American Civil War he was chairman of the Southern Independence Association. He died Oct. 20, 1887.

HOPE, ANTHONY. See HAWKINS, ANTHONY HOPE, under HAWKINS, SIR HENRY, in these Supplements.

HOPEDALE, a town of Worcester County, southeastern Massachusetts, on the Grafton and Upton railroad, 15 miles S.E. of Worcester. Pop. 2,087.

HOPETOUN, EARL OF, JOHN A. L. HOPE, G. C. M. G., P. C., and first Governor-General of the Australian Confederation, was born in Scotland, Sept. 25, 1860, and educated at Eton. In 1879, he passed at Sandhurst, but did not enter the army, having succeeded to the Earldom of Hopetoun in 1873. He was for some years junior whip in the House of Lords, a lord in waiting to Queen Victoria, and Lord High Commissioner to the Church of Scotland. In 1889 he succeeded Sir Henry Loch in the governorship of the colony of Victoria, and was made a G. C. M. G. In 1895, he resigned the governorship and returned to England, and in 1898 was appointed Lord Chamberlain of Her Majesty's household. In 1900, he was gazetted Gov.-Gen. of the Confederated Australian colonies.

HOPFEN, HANS, a German novelist; born in Munich, Jan. 3, 1835; studied law at Munich; lived in Venice, Paris and Vienna, where he was secretary of the German Schiller Institute. He wrote *Peregretta* (1864); the *Grey Friend* (1864); *Juschu, the Journal of an Actor* (1875); *Bavarian Village Tales* (1878); *My First Adventure* (1886); *Robert Lightfoot* (1890).

HOP-FLY (*Aphis* or *Phorodon humuli*), a species of aphid, or plant-louse, which is very destructive to hop-plants. This aphid is pale-green

in color. Both larvæ and the adults feed upon the plants.

HOPHRA, an Egyptian king. See EGYPT, Vol. VII, p. 743.

HOPKINS, EDWARD, an English statesman; born at Shrewsbury in 1600. He emigrated to Boston, Massachusetts, in 1637, and shortly afterward removed to Hartford. From 1640 to 1654 he was governor of the colony every even year, alternating with John Hayes. He then returned to England and became warden of the fleet, commissioner of the Admiralty and member of Parliament. At his death in March, 1657, he left \$3,500 to educational institutions in New England. Hopkinton, Massachusetts, was named after him.

HOPKINS, EDWARD JOHN, an English musician; born in Westminster, June 30, 1818. When 16 years old he was chosen organist of the Mitcham Church; in 1838, of St. Peter's, Islington; in 1841, of St. Luke's, Berwick Street; in 1843 of the Temple Church. Hopkins composed *Out of the Deep* and *God Is Gone Up*, both of which obtained prizemedals; *May Day*, a duet; *Welcome*, a trio; and was the author of *The Organ: Its History and Construction* (1855).

HOPKINS, EDWARD WASHBURN, an American Orientalist; born at Northampton, Massachusetts, Sept. 8, 1857; educated at Columbia College and in Leipzig; instructor at Columbia from 1881 to 1885; associate professor at Bryn Mawr College in 1885, and professor in 1892. He published *Mutual Relations of the Four Castes in Manu* (1884); *Essays on the Social and Military Position of the Ruling Caste in Ancient India* (1889); and *The Religions of India* (1895).

HOPKINS, ESEK, an American naval officer; born in Scituate, Rhode Island, in 1718. In 1775 he was commissioned by the Continental Congress commander-in-chief of the navy, and in February of the following year put to sea with the first squadron sent out by the colonies. He was officially complimented for his success in several engagements, but in 1777 was dismissed from the service for neglecting a summons to appear in Philadelphia. Subsequently he settled in Rhode Island, and several times was chosen a member of the general assembly. He died Feb. 26, 1802.

HOPKINS, JOHN HENRY, an Irish-American clergyman; born in Dublin, Jan. 30, 1792. In 1880 he moved to the United States with his parents; engaged, against his will, in the iron business; failed in business in 1817, and the next year was admitted to the bar; obtained a good practice in Pittsburg, Pennsylvania, but abandoned it for the ministry and was ordained a priest of the Episcopal Church in 1824, having been chosen rector of Trinity Church, Pittsburg, before taking orders. In 1832 he was consecrated the first bishop of Vermont, and became rector of St. Paul's, Burlington. In 1854 he established the Vermont Episcopal Institute at Burlington. Bishop Hopkins was also a musician, poet, artist and architect, having aided in the illustration of Alexander Wilson's *Ornithology* in his youth, and designed the church of which he was rector in Pittsburg. He was the author of *Christianity Vindicated*



(1833); *The Church of Rome in Her Primitive Purity* (1837); *Twelve Canzonets*, words and music (1839); *The "End of the Controversy" Controverted* (1854); *The Pope not the Antichrist* (1868). He was a supporter of the High Church movement. He was one of the first to introduce Gothic architecture into the United States. He died Jan. 9, 1868.

HOPKINS, JOHNS, an American philanthropist; born in Anne Arundel County, Maryland, May 19, 1795, of Quaker parents. He acquired a large fortune in business pursuits, most of which he devoted to philanthropic purposes. In 1873 he founded a hospital in Baltimore, devoting, in all, \$4,500,000 to the institution, which, by the terms of its establishment, was made free to all, independent of race or color. By will he gave \$3,500,000 to found the Johns Hopkins University, one of the most complete educational institutions in



JOHNS HOPKINS.

the country. He also gave Baltimore a public park and an orphan asylum for negro children. He died in Baltimore, Dec. 24, 1873.

HOPKINS, LEMUEL, an American poet and satirist; born in Waterbury, Connecticut, June 19, 1750; studied medicine; practiced in Litchfield, 1776-84, and then moved to Hartford and became member of a coterie called "The Hartford Wits." With them he wrote the *Anarchiad*, a series of satirical essays, which advocated the framing of an efficient Federal constitution. He was also the author of a number of satirical poems and essays, among them *The Echo*; *The Political Greenhouse*; *New Year's Verses*; and is said to have written a version of the 137th psalm. He died April 14, 1801, in Hartford, Connecticut.

HOPKINS, MARK, an American educator; born at Stockbridge, Massachusetts, Feb. 4, 1802. He graduated at Williams College in 1824; tutor in that institution from 1825 to 1827; studied medicine and graduated at the Berkshire Medical School in 1829; began practice in New York City, but in 1830 was called to fill the chair of moral philosophy and rhetoric at Williams; two



MARK HOPKINS.

years later was licensed to preach; in 1836 he took the chair of moral and intellectual philosophy, which was established for him, and succeeded Dr. Griffin as president of the college; resigned this position in 1872, but retained his professorship and the pastorate of the college chapel. In 1857 was elected president of the American Board of Foreign Missions. Dr. Hopkins was a very successful educator, and did much toward improving the material conditions and increasing the

intellectual prestige of the college with which he was connected during his entire life. Among his published works are *The Law of Love and Love as a Law* (1869); *An Outline Study of Man* (1873); *Evidences of Christianity* (1846); *Lectures on Moral Science* (1862); *Strength and Beauty* (1874); *Scriptural Idea of Man* (1883). Hopkins Memorial Hall at Williams College was built to commemorate his name. Dr. Franklin Carter has written his *Life* (1892). He died at Williamstown, Massachusetts, June 17, 1887.

HOPKINS, STEPHEN, a signer of the Declaration of Independence; born at Scituate, Rhode Island, March 7, 1707; moved to Providence in 1731, elected member of the assembly of the colony in 1732; was annually re-elected until 1738; re-elected again in 1741 and became speaker; governor, with a year's exception, from 1754-68; delegate to the Continental Congresses from 1774 to 1778. He wrote *History of the Planting and Growth of Providence* (1765). He died July 13, 1785.

HOPKINS, WILLIAM, an English geologist; born in 1793. He went into business, and not being very successful, in 1823 entered St. Peter's College, Cambridge. After graduation he became private tutor, and soon won a reputation as instructor of mathematics. His friendship with Professor Sedgwick led him to turn his attention to geology, and particularly to the mathematics of geology, in which field his investigations were largely carried on. He was elected president of the Geological Society in 1851-52, and, in the following year, of the British Association. He died Oct. 13, 1886.

HOPKINS, WILLIAM E., an American naval officer; born in Virginia in 1821. He entered the Naval Academy in 1839; graduated and served on the *Tandalia* in 1845; was attached to the Naval School in Washington, District of Columbia; commissioned lieutenant, 1854. During the Civil War he commanded in the Pacific squadron; was commissioned commander in 1863. In 1870 was made captain and given an appointment at Mare Island navy-yard, where he remained two years; was made commodore in 1881, and given charge of the New London naval station; retired in 1882. He died in San Francisco, Oct. 24, 1894.

HOPKINSON, JOHN, an English electrical engineer; born at Manchester, England, in 1840; educated at Owens College, Manchester, and at Trinity College, Cambridge; in 1872 moved to Birmingham and began the career of engineer; in 1878 went to London. He carried on exhaustive researches in the field of magnetism and electrostatics, the results of which have been published under the title of *Original Papers on Dynamo Machinery and Allied Subjects*. He is said to have been the first to express electrical phenomena graphically by means of curves.

HOPKINSON, JOSEPH, an American jurist; born in Philadelphia, Nov. 12, 1770; graduated at the University of Pennsylvania in 1786, and in 1791 was admitted to the Pennsylvania bar; in 1814 was elected a Representative to Congress; in 1828 was appointed United States judge for the eastern district of Pennsylvania. During the impeachment

proceedings in the United States Senate against Salmon Chase. Hopkinson was the defendant's counsel. Mr. Hopkinson was the author of the national song, *Hail Columbia*, which he wrote in 1798. He died in Philadelphia, Jan. 15, 1842.

**HOPKINSVILLE**, a city and the capital of Christian County, southwestern Kentucky, situated 71 miles N.W. of Nashville, Tennessee, on the Louisville and Nashville and the Ohio Valley railroads. The locality is very fertile, and produces tobacco, coal and iron. The city contains South Kentucky (Christian) College, two seminaries, a State insane asylum and manufactories of carriages and plows. It was almost wholly destroyed during the Civil War by the Confederates. Population 1890, 5,833; 1900, 7,280.

**HOPLOPHORIDÆ**. See *Glyptodon*, under **MAMMALIA**, Vol. XV, pp. 387, 388.

**HOPPE-SEYLER**, **FELIX**, a German physiologist; born in Freiburg, Prussia, Dec. 26, 1825; was a physician in Berlin, 1852-54; professor in Berlin, 1860; in Tübingen, 1861; in Strasburg, 1872; in 1877 editor of the *Zeitschrift für Physiologische Chemie*; published *Handbook of Physiological and Pathological Chemical Analysis: Medico-chemical Investigations; Physiological Chemistry*. For his investigations concerning the chemical composition of chlorophyll, see **PHYSIOLOGY**, Vol. XIX, p. 53.

**HOPPIN**, **AUGUSTUS**, an American author and illustrator; born in Providence, R. I., July 13, 1828. He graduated at Brown University in 1848, studied law and was admitted to the bar, but gave up practice and devoted himself to art. He illustrated *The Potiphar Papers: Nothing to Wear; The Autocrat at the Breakfast Table*, and other well-known works. He published *Carrot Pomade* in 1864; took a trip in Europe, and upon his return published a series of sketch-books written and illustrated by himself: *On the Nile* (1871); *Ups and Downs on Land and Water* (1871); *Crossing the Atlantic* (1872). Among other works are *Jubilee Days* (1872); *Recollections of Auton House* (1881); *Married for Fun* (1885). He died in Flushing, N. Y., April 1, 1896.

**HOPPIN**, **JAMES MASON**, an American educator; born in Providence, Rhode Island, Jan. 17, 1820; graduated at Yale in 1840; in 1842 at Harvard Law School, and in 1845 from Andover Theological Seminary. From 1850 to 1859 he was pastor of the Congregational Church at Salem, Massachusetts, and two years later became professor of homiletics in Yale; in 1879 became professor of the history of art at Yale. He was the author of *Notes of a Theological Student* (1854); *Old England* (1867); *Office and Work of the Christian Ministry* (1869); *The Early Renaissance* (1892).

**HOPPIN**, **THOMAS FREDERICK**, an American artist; born in Providence, Aug. 15, 1816; and studied in Paris under Delaroche. He designed the figures of St. Peter and St. Paul, in the window in Trinity Church, New York, and is said to have modeled the first statue cast in bronze in the United States.

**HOPPS**, **JOHN PAGE**, an English clergyman and author; born in London, Nov. 6, 1834. He was educated at the Baptist College, Leicester, and en-

tered the Baptist ministry in 1855; assistant at the Church of the Saviour, Birmingham, in 1858. In 1860 he became a Unitarian, and accepted a call from a Unitarian church in Sheffield; afterward held pastorates at Dunkinfield and Glasgow, and in 1876 became pastor of the Great Meeting, Leicester. From 1863 to 1887 he was the owner and editor of the *Truthseeker*, and afterward editor of the *Coming Day*. For thirty years he held Sunday afternoon meetings of working-people. He wrote almost thirty published works, among them *Seven Lectures for the People* (1861); *Verses by the Way* (1865); *The Life of Jesus. Rewritten for Young Disciples* (1869); *Hymns, Chants and Anthems* (1877); *The Revised New Testament* (1881). He also wrote a series of papers on the *Irish Question*, and published the most widely circulated statement of the Unitarian faith, 400,000 copies of which were distributed.

**HOPS AND HOP CULTURE**. See **AGRICULTURE**, Vol. I, p. 381; **BREWING**, Vol. IV, pp. 272, 273; and Vol. XII, pp. 156-158.

**HOP-TREE**, a name given to *Ptelea trifoliata*, a genus of the family *Rutaceæ*. It is a tall shrub or small tree, native throughout the middle and central United States, with leaves consisting of three ovate leaflets, terminal clusters of small, greenish-white flowers, and round-winged bitter fruit, which is used as a substitute for hops.

**HOPWOOD**, **CHARLES HENRY**, an English jurist and public man; born in England in July, 1829. He was called to the bar by the Middle Temple, in 1853; practiced on the northern circuit and in London, and was made Queen's counsel in 1874. He was elected member of Parliament for Stockport, 1874, and was returned again in 1880, but rejected in 1885. He was elected a bencher of the Middle Temple in 1874, and reader, 1885; was appointed recorder of Liverpool, February, 1886; re-elected to Parliament from the Middle Division of Lancashire in 1892. He was always an advanced Liberal in politics.

**HOQUIAM**, a post village of Chehalis County, Washington, on Hoquiam River, where it flows into Gray's Harbor. Its principal industries are lumbering, fishing and fish-canning, and fur trade. Aberdeen, the nearest railroad station, is on the Northern Pacific, 4 miles to the east. Population 1890, 1,302; 1900, 2,608.

**HORE**, **ANNIE BOYLE**, an English traveler and authoress, wife of Edward Coode Hore; born in Bloomsbury, London, April 8, 1853. In 1882 she commenced her travels in Central Africa, her first journey being from Saadani to Mambria, two hundred miles inland. In 1884 she attempted to reach Tanganyika by the Nyasso route, but was compelled to return, owing to the war between the Portuguese and the natives. A month later she joined her husband at Delagoa Bay, and together they reached Lake Tanganyika via Ujiji and Unyamwezi. She was the first white woman to reach Tanganyika. She spent four years on Kavala Island, teaching children the rudiments of Christianity and civilization. Mrs. Hore wrote an entertaining book of travels, *To Lake Tanganyika in a Bath Chair* (1887).

**HORE**, **EDWARD COODE**, an English seaman and

traveler; born in Islington on July 23, 1848, of Cornish parentage. He was apprenticed, at the age of sixteen, to the owner of a London ship, and visited nearly every part of the world. He rose to the rank of captain. In March, 1877, Captain Hore was appointed to the London Missionary Society's pioneer expedition in Central Africa. He lived on the shores of Lake Tanganyika for about ten years, surveyed its coast-line in a log canoe and discovered the Lukuga to be the true outlet of the lake. In 1882 he took the sections of a steel lifeboat on tracks from Saadani to Ujiji, a distance of 836 miles, in less than 100 days. In 1888 he finished the building of the steam-yacht, *The Good News*, on Lake Tanganyika. Captain Hore received a gold chronometer from the government of the French Republic for attention and assistance to the late Abbé Debaize; and in 1890 received the Cuthbert Peek grant from the Royal Geographical Society. He published *Tanganyika: Eleven Years in Central Africa*. In 1894 he was appointed by the London Missionary Society commander of the *John Williams*, to go to Polynesia.

**HOREB, MOUNT.** See SINAI, Vol. XXII, p. 88; ISRAEL, Vol. XIII, p. 396, note; and ELIJAH, Vol. VIII, pp. 135, 136.

**HORICON**, a village in Dodge County, southeastern Wisconsin, situated on Rock River and the Chicago, Milwaukee and St. Paul railroad. It has a wagon and windmill factory and two farming-tool works. Grain is raised in the surrounding country. Population 1900, 1,376.

**HORITES OR HORIM.** See IDUMEA, Vol. XII, p. 699; and TROGLODYTES, Vol. XXIII, p. 583.

**HORIZON.** See GEOGRAPHY, Vol. X, pp. 198, 199.

**HORN, CAPE.** See GEOGRAPHY, Vol. X, p. 186; and TIERRA DEL FUEGO, Vol. XXIII, p. 383-85.

**HORN, CHARLES EDWARD**, an English musician; born in London in 1786; studied music under his father and made his début as an opera singer in 1809, in London; came to the United States in 1827, and sang in opera; returned in 1831, and became director of music at the Olympic; in the following year came back to America and opened a music store in New York; was chosen conductor of the Handel and Haydn Society of Boston in 1847. He composed the opera *The Magic Bride*; the oratorios, *The Remission of Sins*; and *Daniel's Prediction*; and a number of popular songs, among them *The Deep, Deep Sea*; *Cherry Ripe*; and a duet, *I Know a Bank Whereon the Wild Thyme Blows*. His voice was a baritone of indifferent quality. He died in Boston, Oct. 27, 1849.

**HORN, EDWARD TRAILL**, an American Lutheran clergyman; born in Easton, Pennsylvania, June 10, 1850. He was educated at Pennsylvania College; graduated at the Philadelphia Theological Seminary in 1872; became pastor of Christ Church, Philadelphia, in 1872, and in 1876 was chosen pastor of St. John's in Charleston, South Carolina. He advocated the adoption of a common service for all English-speaking Lutheran Churches, and was made secretary of the joint committee which effected this reform in 1888. He published *The Christian Year*

(1876); *History of St. John's, Charleston* (1886); *The Evangelical Pastor* (1887); *Outlines of Liturgies* (1890).

**HORN, GUSTAF CARLSSON**, a Swedish general; born at Orbyhus, Oct. 22, 1592; studied at Rostock, Jena and Tübingen, and entered the Dutch Army under Prince Maurice of Orange. In 1624 entered the Swedish army and fought under Gustavus Adolphus in the Thirty Years' War; was taken prisoner in the battle of Nördlingen in 1634; was exchanged in 1642 and returned to Sweden; was made count and field-marshal in 1651. He died at Skara, May 10, 1657.

**HORN OR HOORNE, PHILIPPE**, COUNT OF, a Dutch soldier; born about 1520. He fought in the battles of St. Quentin and Gravelines. When Philip II attempted the reconstruction of the Flemish clergy and the inauguration of the Inquisition in the Netherlands, Horn, although a Catholic, with Egmont and William of Orange, opposed his policy, but refused to sign the "Compromise" or join the "Beggars." Despite this and other proofs of loyalty, Horn and Egmont were seized at Brussels by order of Alva in 1567, tried on a trumped-up charge, and executed June 5, 1568. See HOLLAND, Vol. XII, pp. 74, 75.

**HORNADAY, WILLIAM TEMPLE**, an American biologist and author; born near Plainfield, Indiana, Dec. 1, 1854; was educated at the Iowa Agricultural College, and afterward employed in the laboratory of Henry A. Ward, in Rochester, New York; in 1874-75 was sent by Ward to Florida and Cuba to collect specimens of natural history; in 1876, to the West Indies and South America; and in 1876-79, around the world; appointed chief taxidermist to the United States Museum at Washington in 1882; in 1886 was sent to Montana to get specimens of bison for the museum. He wrote *Two Years in the Jungle* (1885); *Canoe and Rifle on the Orinoco* (1885); *The Man Who Became a Savage* (1896); and also of a work on *Taxidermy* and a memoir on the *Extinction of the American Bison*.

**HORNBLLENDE.** See GEOLOGY, Vol. X, p. 228; MINERALOGY, Vol. XVI, p. 417; and ASBESTOS, Vol. II, pp. 675, 676.

**HORNBLOWER, WILLIAM BUTLER**, an American jurist; born in Paterson, New Jersey, May 13, 1851; educated at Princeton, and graduated at the Columbia Law School in 1875; practiced in New York; in 1890, was put upon the commission to revise the judiciary articles of the New York state constitution; was president of the Princeton Alumni Association and secretary of the New York Bar Association; author of *Conflict between Federal and State Decisions* (1880); *Lawful Status of the Indians* (1891). He was nominated in 1894 for a place on the United States supreme bench by President Cleveland, but for political reasons the Senate refused to confirm the nomination.

**HORNBY, SIR GEOFFREY THOMAS PHIPPS**, an English naval officer, born in 1825; entered the navy in 1837, and was present as a midshipman at the bombardment of Acre. He commanded the first flying squadron as captain, taking it around the world; succeeded Admiral Wellesley as rear-ad-

miral, attaining flag rank in 1869; made vice-admiral in 1875. He was commander-in chief of the naval forces in the Mediterranean in 1878, when war was imminent between England and Russia. He was a lord of the admiralty under Lord Beaconsfield's administration; in 1881 was appointed president of the Royal Naval College, at Greenwich, for a term of three years. He died March 3, 1895.

HORNBY, JAMES JOHN, an English educator, son of Admiral Hornby; born in England in 1826; educated at Eton, and at Balliol College, Oxford, where, in 1849, he took a first-class in classics. In the same year he became a fellow of Brasenose College, and in 1854 tutor and principal of Bishop Cosen's Hall in the University of Durham. Returning to Oxford in 1864, he became classical lecturer at Brasenose, and in 1866 was senior proctor of the university. At the close of the latter year he was elected second master of Winchester School, which post he retained till his appointment as head-master of Eton in January, 1868. Dr. Hornby was appointed one of Queen Victoria's honorary chaplains in February, 1882, and made D.C.L. of Durham University the same year. He was appointed to the provostship of Eton, July, 1884.

HORN-CORALS, a name given to corals of the family *Antipatharia*, belonging to the order *Hexacorallia*. These colonies form a branching axial skeleton of a black, horny substance. The skeletons somewhat resemble the sea-fans in form, but these are formed by coral polyps of an entirely different order. See CORALS, Vol. VI, p. 372.

HORNE, RICHARD HENRY OF HENGIST, an English author; born in London, Jan. 1, 1803. He was educated in Sandhurst College, and, failing to get a desired military appointment in the East India Company's service, became midshipman in the Mexican navy; returned to England, and settled in London as man of letters; emigrated to the gold-fields of Australia in 1852 and remained until 1869. He published dramas, poems and historical works, among them *Cosmo de' Medici* (1837); and *Gregory the Seventh* (1840), tragedies; *Life of Napoleon* (1841); *Orion: an Epic Poem* (1843); *The South Sea Sisters* (1866). He died March 13, 1884.

HORNED SNAKE. See *Viper cerastes*, under VIPER, Vol. XXIV, p. 247.

HORNED TOAD, a popular name of lizards of the genus *Phrynosoma*, found in the Western states. It is often known as California toad. See LIZARD, Vol. XIV, p. 736.

HORNELLSVILLE, a city of Steuben County, southwestern New York, on the Canisteo River, and the New York, Lake Erie and Western and the Central New York and Western railroads, 58 miles S. of Rochester. It is well laid out, lighted with electricity and provided with a public library containing 11,000 volumes. The New York, Lake Erie and Western railroad has large shops here. It manufactures doors, sash and blinds, wire-fencing, boots and shoes, furniture, tanned leather, dynamos and electric motors and apparatus. Population 1890, 10,996; 1900, 11,918.

HORNER'S METHOD, in algebraic equations.

See ALGEBRA, Vol. I, p. 516; and EQUATION, Vol. VIII, pp. 500, 501.

HORNET. See WASP, Vol. XXIV, p. 392.

HORNSEY, an English town on the northern outskirts of London, with a population of about 12,000. It also gives its name to a parliamentary division of the county of Middlesex.

HORNSTONE. See GEOLOGY, Vol. X, p. 238; and MINERALOGY, Vol. XVI, p. 389.

HOROLOGY. See CLOCKS, Vol. VI, pp. 13-35; WATCH, Vol. XXIV, pp. 394-398; and STANDARD TIME, in these Supplements.

HOROPTER. See EYE, Vol. VIII, p. 826; and STEREOSCOPE, Vol. XXII, p. 538.

HOROSCOPE. See ASTROLOGY, Vol. II, p. 742; and MAGIC, Vol. XV, p. 206.

HORSA. See ENGLAND, Vol. VIII, p. 269.

HORSE DISTEMPER, a term which has erroneously been applied to certain diseases which come under the classification of *Influenza*; q.v., VETERINARY SCIENCE, Vol. XXIV, p. 203.

HORSE-FLY, a popular name of several dipterous insects of widely different genera, which are troublesome to horses. The *Tabanide* are the true horse-flies. The females have a long proboscis, which is used for drawing blood from beneath the skin. The name is also applied to the bot-flies (*Estridae*), and to the forest-fly (*Hippobosca*) of the British Isles.

HORSE-GENTIAN, a name applied to species of *Triosteum*, a genus of the family *Caprifoliaceae*, or honeysuckles. They are erect and coarse, leafy herbs, with oval or lanceolate leaves, flowers sessile in the axils of the leaves, and fleshy orange or red fruit crowned with the persistent calyx-lobes. A still more common name for the genus is feverwort. The root has been used in medicine and the seeds for coffee.

HORSE GUARDS. See ARMY, Vol. II, p. 578; and LONDON, Vol. XIV, p. 839, and GUARDS, THE, in these Supplements.

HORSEHEADS, a town of Chemung County, central southern New York, on the Northern Central and the Elmira, Cortland and Northern railroads, and on the Chemung canal. It contains a woolen-mill, saw-mill and a very large brickyard. Population 1890, 1,716; 1900, 1,901.

HORSE ISLAND, an island in Lake Ontario, and in Jefferson County, New York, two miles from Sackett's Harbor. It has a lighthouse. Area, 27 acres.

HORSEMANSHIP. See HORSE, Vol. XII, p. 199.

\*HORSE-RACING.—*Running*. Since 1880 many and vast have been the changes brought about on the American running-turf. About the year named the sport was gaining immensely in popularity, and the racing associations and jockey clubs were reaching a stage of prosperity which enabled them to endow their stakes with large amounts of money. The breeding interest was greatly stimulated, and the quality of the American thoroughbred improved in a marked manner. In fact, there is little question that in the early eighties the thoroughbreds then in training were superior to those that have been raced in 1896. The substitution of bookmaking for pool-selling increased the revenues of the jockey clubs,

the profits derived from the holding of meetings were large, and new associations, good, bad and indifferent, sprang up on all sides. Among the most important of these were the magnificent private enterprises of the Morris confederacy at Morris Park, Westchester, New York, which has since passed into the ownership of the Westchester Racing Association, and the Washington Park Club of Chicago, which built and equipped a splendid racing property, and between 1884 and 1894 held a series of brilliant meetings. The latter club endowed a rich stake, which it named the American Derby, and within a year or two of its institution "Derby Day" became the occasion of the chief social festival of the year in Chicago. During the Columbian season—1893—this stake was worth \$50,000; forty-five thousand people turned out to see the race run, and when the victory was won the secretary of the association handed J. E. Cushing, owner of the winner, Boundless, a check for \$50,000—the largest sum of money ever paid, in the equivalent of cash, in America to the winner of a single race. As might be supposed, the profits accruing from the holding of racing-meetings attracted the attention of many unscrupulous people, and racing was carried on at various points, winter and summer, regardless of all else save the making of money. New Jersey, being easy of access to New York, was over-run with race-tracks, and latterly, at Guttenberg and Gloucester, racing was carried on summer and winter, rain or shine, without stopping, every week-day, for practically two years. The laws of almost all the states had not been framed in contemplation of any such procedure, but it was not long before this mad rush for wealth had its effect, first in New York. The legislature of that state passed the Ives Bill (now superseded by the Percy-Gray Law), which limited racing to thirty days in each year for each association, and prohibited the holding of meetings in the months of January, February, March, April, November and December. This effectually put a stop to winter racing in New York, but it was not until later that the people of New Jersey arose in their might, cast off the yoke the gamblers had placed upon them, elected officials hostile to racing, and since 1893 there has been no racing done in New Jersey. In Illinois history repeated itself. Continuous racing arrayed the people against the sport, and in 1895 the Civic Federation of Chicago caused the closing of the Hawthorne track. No racing was done in Chicago in 1895 and 1896. In various other commonwealths legislation hostile to racing has been accomplished, but the people in general are coming to recognize that the test of the race-course is necessary to the maintenance and improvement of the race-horse, and the indications are that in a few years wise restrictive measures will be framed for and in each state, permitting the reputable association to conduct honorable business, and shutting out such associations as aim only to make money, regardless of the horse and all else.

It is a question whether the American thoroughbred has been really improved during the past decade and a half. The tendency has been toward shorter races than were formerly favored, and hence

the horses have not been trained to compass distances of three and four miles. The records given below indicate that speed has increased, but it must be remembered that the courses have been materially improved. Toward the end of the last decade, and during the first two years of the present, prices of thoroughbreds were very high. W. O'B. McDonough paid \$150,000 for Ormonde, winner of the "triple event" in England. Charles Reed paid \$100,000 for the imported English horse St. Blaise, winner of the Derby, and other prices were paid in proportion. These long prices were superinduced by the amounts of money that could be won in races. In 1891 His Highness won upward of \$107,000, and in 1893 Domino placed to his owner's credit \$176,000 won in stakes alone. The revenues of the New York racing associations having been very greatly reduced by the operation of the Percy-Gray Law, and racing having been stopped altogether in Chicago, it is not now possible to win such large sums of money, and as the value of a race-horse is largely determined by that which he can win, prices of thoroughbreds have lately been markedly reduced. Owners, however, may race winter as well as summer, the establishment of two magnificent racing-plants in San Francisco insuring, in addition to the meeting at New Orleans, an abundant opportunity to race in a warm climate during the winter months. Since 1880 the American turf may be said to have risen and fallen. The Jockey Club, formed in 1894 for the purpose of governing Eastern racing, is proving itself a powerful body, infinitely superior to any or all of the governing committees that preceded it. Under its wise rule racing is sure to prosper in the East. This body differs materially from any other that has essayed to govern racing in America. It is modeled after the pattern of the English Jockey Club, and has been endowed with certain plenary powers by act of the legislature of the state of New York. Under the Percy-Gray Law, above referred to, a racing commission of three, appointed by the governor, practically controls all racing done in the state, and this commission works in harmony with the Jockey Club. This commission is supported by a tax levied on the various racing associations. In the West, racing is governed by the Western Turf Congress, a body composed of representatives of the leading racing associations not affiliated with the Jockey Club. The difference between this body and the Jockey Club consists in the fact that the members of the former directly represent racing associations, while the members of the latter do not, but are simply banded together without self-interest to serve to govern the turf honestly and progressively. As might be supposed from the composition of the Western Turf Congress, its machinery has been used on occasion to further the aims, objects and desires of certain of its members, not always for the good of the sport. Advanced sentiment has at length crystallized in the belief that a Western jockey club, to take the place of the Western Turf Congress, is a necessity. This new body will consist, not of presidents or controllers of Western racing associations acting as such, but of prominent

gentlemen of undeniable social standing, who are thoroughly capable of governing the turf, and whose only aim will be to furnish the public clean sport.

In 1881 the English Derby was won by the American-bred horse Iroquois, which also won the St. Leger. The same year another American-bred horse, Foxhall, won the Grand Prix de Paris in France, and the great autumn handicaps at Newmarket, England, the Cesarewitch and Cambridgeshire—a wonderful feat for a three-year-old. In the years immediately succeeding, the American horses did little in England, and were withdrawn. In 1895 Richard Croker, well known as chief of Tammany Hall, and Michael F. Dwyer took a stable of well-known performers to England, but bad luck attended the undertaking from beginning to end. Dobbins broke down, Stonenell and Banquet were claimed out of selling-races, Harry Reid was retained at a sacrifice and brought back home again, and altogether the campaign was far from successful. In 1896 Duke and Wishard took a large stable of American thoroughbreds, including the great handicap horse, Ramapo, to England. Pierre Lorillard took another large stable, chiefly two-

notoriously much higher in England than in America, the extreme limit of price in 1896 being, in England, \$26,500, and in the United States, \$9,000, these figures, of course, being reached at public auction.

In the Dominion of Canada, racing is, for the most part, conducted on a high plane, and it was not until 1895 that any attempt was made to conduct a continuous meeting at any Canadian point. That year some American promoters established themselves at Windsor, Ontario, just across the river from Detroit, Michigan, and brought the sport into great disrepute in that corner of the province. In the winter of 1895-96 the Dominion Parliament passed a law incorporating the Canadian Jockey Club, and granting that body certain powers, which it was hoped would be used for the suppression and prevention of continuous racing. Anticipations, however, have not been realized.

Some difference of opinion exists among the best judges as to the relative merits of the English and American thoroughbreds. In point of speed alone, however, the American horse may be said to lead. Following are the best running-records:

MILES.		TIME.
$\frac{1}{4}$	BOB WADE, 4, at Butte, Montana, Aug. 20, 1890.	0:12 $\frac{1}{4}$
$\frac{1}{2}$	GERALDINE, 4, 122 lbs., at New York Jockey Club (straight course, partly downhill), Aug. 30, 1889	0:46
$\frac{1}{2}$	APRIL FOOL, 4, 122 lbs., at Butte, Montana, July 31, 1891	0:47
$\frac{5}{8}$	MAID MARIAN, 4, 111 lbs., at Morris Park (straight track, partly downhill), Oct. 9, 1894	0:56 $\frac{3}{4}$
F	urity Course (170 feet less than $\frac{3}{4}$ mile). KINGSTON, aged, 139 lbs., at Sheepshead Bay, June 22, 1891	1:08
$\frac{3}{4}$	DOMINO, 2, 128 lbs., at Morris Park (straight course, partly downhill), Sept. 29, 1893	1:09
$\frac{3}{4}$	O'CONNELL, 5, 121 lbs., at Oakley, July 18, 1895	1:12 $\frac{1}{4}$
$\frac{7}{8}$	CLIFFORD, 4, 127 lbs., at Sheepshead Bay, Aug. 29, 1894	1:25 $\frac{3}{4}$
$\frac{7}{8}$	BELLA B., 5, 103 lbs., at Monmouth Park, July 8, 1890 (straight course)	1:23 $\frac{1}{2}$
1	SALVATOR, 4, 110 lbs., at Monmouth Park, Aug. 28, 1890 (against time, straight course)	1:35 $\frac{1}{2}$
1	KILDEER, 4, 91 lbs., at Monmouth Park, Aug. 13, 1892 (straight course)	1:37 $\frac{1}{4}$
1	LIBERTINE, 3, 90 lbs., at Chicago (Harlem), Oct. 24, 1894	1:38 $\frac{3}{4}$
1	REDSKIN, 6, 98 lbs., at Forsyth, Indiana, June 6, 1896	1:45 $\frac{1}{2}$
1	TRISTAN, 6, 114 lbs., at New York Jockey Club, June 2, 1891	1:51 $\frac{1}{2}$
1	BOANERGES, 4, 110 lbs., at Chicago, July 7, 1898	1:58 $\frac{1}{4}$
1	BANQUET, 3, 108 lbs., at Monmouth Park (straight course), July 17, 1890	2:03 $\frac{3}{4}$
1	DAVID TENNY, 4, 100 lbs., at Chicago (circular track), July 16, 1898	2:04 $\frac{1}{2}$
1	ALGOL, 4, 107 lbs., at Chicago, July 23, 1898	2:04 $\frac{1}{2}$
1	SABINE, 4, 100 lbs., at Chicago (Washington Park), July 5, 1894	2:18 $\frac{3}{4}$
1	GOODRICH, 3, 102 lbs., at Chicago, July 16, 1898	2:30 $\frac{1}{4}$
1	HINDOOCRAFT, 3, 75 lbs., at New York Jockey Club, Aug. 27, 1889	2:48
1	BEN HOLIDAY, 4, 118 lbs., at Morris Park, Oct. 23, 1897	2:59 $\frac{1}{4}$
1	ENIGMA, 4, 90 lbs., at Sheepshead Bay, Sept. 15, 1885	3:20
2	JUDGE DENNY, 5, 105 lbs., at San Francisco, Feb. 12, 1898	3:26 $\frac{1}{2}$
2	TEN BROECK, 5, 110 lbs., at Louisville, May 29, 1877 (against time)	3:27 $\frac{1}{2}$
2	NEWTON, 4, 107 lbs., at Chicago (Washington Park) July 13, 1893	3:27 $\frac{1}{2}$
3	DRAKE CARTER, 4, 115 lbs., at Sheepshead Bay, Sept. 6, 1884	5:24
4	LUCRETIA BORGIA, 4, 85 lbs., at Oakland, Cal., May 20, 1897 (against time)	7:11
4	TEN BROECK, 4, 104 lbs., at Louisville, Sept. 27, 1876 (against time)	7:15 $\frac{3}{4}$

year-olds, and one or two other owners shipped smaller lots. A large number of yearlings, mostly the get of Hanover, were shipped to Richard Croker, and many nominations of American-bred colts and fillies made in the English classic races. In 1896 the American horses were much more successful than in 1895—three races out of six being won one afternoon at an important meeting by them. Mr. Lorillard's horses made such a favorable impression that a one-half interest in his entire stable in England was purchased by Lord William Beresford. From this time forward many American horses will be raced each year in England, and it is quite likely that the breeders of the United States may seek to establish a market for their yearlings there. Prices for good thoroughbred yearlings are

See also TROTTING AND PACING, in these Supplements. J. H. S. JOHNSTONE.

HORSE-RADISH TREE, the *Moringa pterygo-sperma*, a tree common in India and Arabia, and cultivated in various other tropical countries. The fruit is eaten as a vegetable or pickled, and its seeds are important as furnishing the commercial oil of ben. The fresh root has an odor and taste resembling that of the horse-radish.

HORSESHOE CRABS. See *Limulus*, under CRUSTACEA, Vol. VI, pp. 648-650, 662.

HORSE-SHOEING. See SHOES, HORSE, Vol. XXI, pp. 831, 832.

HORSES IN THE UNITED STATES. See AGRICULTURE and HORSE-RACING in these Supplements.

**HORSE-TICK.** See **FOREST-FLY**, in these Supplements.

**HORSFORD, EBEN NORTON**, an American chemist; born in Genesee, New York, July 27, 1818; studied engineering at the Rensselaer Polytechnic Institute, and was engaged on the geological survey of the state of New York. In 1840 he was appointed professor of mathematics in the Academy for Women at Albany, where he remained for four years. He afterward studied in Germany, under Liebig, and on his return to the United States, in 1847, was elected Rumford professor of science at Harvard. After sixteen years' service there, he resigned, to engage in chemical experiments and manufacturing, and became president of the Rumford Chemical Works, Providence, Rhode Island. He published *The Discovery of America by Northmen* (1888). He died in Cambridge, Massachusetts, Jan. 1, 1893.

**HORSLEY, JOHN CALCOTT**, an English artist; born in London, Jan. 29, 1817; entered the schools of the Royal Academy in 1831; elected an associate of the academy in 1855; academician, 1865. Drapery of the human figure became his hobby, and so earnest was his abhorrence of the nude that his prudery became satirized by the sobriquet "Clothes-Horsley." His quality as an artist is well attested by his appointment as a head-master of the School of Designs of Somerset House, the receipt of several prizes for cartoons exhibited at Westminster Hall, and the excellence of various works, both oil-paintings and etchings. Among his pictures are *Winning the Game and The Pride of the Village* (1839); *Lady Jane Grey and Roger Ascham* (1853); *Showing a Preference* (1863); *The Morning of St. Valentine* (1866); *Stolen Glances* (1874); *Fashions Change* (1878); etc. His cartoons adorn the House of Lords and the new Houses of Parliament.

**HORSLEY, VICTOR ALEXANDER HADEN**, an English surgeon, son of John Calcott Horsley; born April 14, 1857, at Kensington; educated at the Cranbrook School and the University College Hospital; was appointed on the surgical staff of the hospital; from 1884 to 1890, was professor-superintendent of the Brown Institution; from 1891 to 1893, Fullerian professor at the Royal Institution; in 1886, elected to the Royal Society. He experimented widely in brain physiology, and wrote several papers on the subject. Among his publications are *Injuries and Diseases of the Neck* (1886); and *Experiments on the Functions of the Cerebral Cortex* (1888).

**HORTA.** See **AZORES**, Vol. III, p. 172.

**HORTON**, a city of Brown County, northeastern Kansas, on the Chicago, Rock Island and Pacific railroad, 22 miles W.S.W. of Atchison. It is the site of the manufacturing and repair shops of this railroad for the entire system west of the Mississippi. It is the shipping-point for an agricultural and stock-raising region. Population 1890, 3,316; 1900, 3,398.

**HORTON, SAMUEL DANA**, an American publicist; born at Pomeroy, Ohio, Jan. 16, 1844. He was educated at Harvard and graduated from the Harvard law school in 1868; after studying abroad, began practice in Cincinnati, but spent most of his life abroad studying monetary questions. He was a delegate to the Monetary Conference of Paris,

1871, and to the conference of 1881. He advocated the maintenance of an international ratio between gold and silver. At the time of his death he was in Washington at the request of the administration, to consult about the financial situation. He published *Silver and Gold and Their Relation to the Problem of Resumption* (1876); *The Silver Pound and England's Monetary Policy Since the Restoration* (1887); *The History of the Guinea* (1887); and *Silver in Europe* (1890). He died in Washington, District of Columbia, Feb. 23, 1895.

**HORUS.** See **AMMON**, Vol. I, pp. 740, 741; and **EGYPT**, Vol. VII, p. 717.

**HORVATH, MICHAEL**, a Hungarian historian; born at Szentes, in the County of Csongrad, Oct. 20, 1809. He studied theology at the Seminary of Waitzen, took orders in 1830, in 1844 became professor of the Hungarian language and literature in Vienna, and four years later bishop of Csanad. During the Revolution of 1848 he received the appointment of Minister of Public Instruction and Worship. The defeat of the Hungarians drove him into exile. Under the amnesty of 1867 he was permitted to return. His most important work is his *History of Hungary* (8 vols., 1842-46). He died at Carlsbad, Aug. 19, 1878.

**HOSACK, DAVID**, an American botanist; born in New York, Aug. 31, 1769; educated at Columbia College and the College of New Jersey; received his M.D. in Philadelphia in 1791; studied in Edinburgh and London; in 1795 became professor at Columbia; at the College of Physicians and Surgeons in 1807; 1826 to 1830 held a professorship at Rutgers Medical College. He was the author of *Hortus Elginensis*; *Memoir of Hugh Williamson* (1820); *Essays on Medical Science* (1824-30); and *Theory and Practice of Physic* (1838). He died in New York, Dec. 23, 1835.

**HOSEA, KING.** See **ISRAEL**, Vol. XIII, p. 412.

**HOSMER, HARRIET G.**, an American sculptress; born at Watertown, Massachusetts, Oct.

6, 1830; was educated at Lenox, Massachusetts, and early displayed a taste for art. She received a few lessons in modeling in Boston, then entered a medical college in St. Louis to study anatomy and dissection. Her first work in marble was a reduced copy of Canova's bust of Napoleon, which was fol-



HARRIET G. HOSMER.

lowed soon by an ideal work, *Hesper, or the Evening Star*. In 1852 she went to Rome and became a pupil of Gibson. After two years of study and modeling from the antique she produced the busts of *Daphne* and *Medusa*. Her first full-length figure in marble was *Enone*, completed in 1855, and this was followed, two years later, by *Beatrice Cenci Sleeping in Her Cell*. In the summer of 1865 she modeled *Puck*, of which many copies have been made. This was followed by *Will-o'-the-Wisp*. A colossal statue of *Zeno's*

*Queen of Palyrma, in Chains*, was her next important work, followed by a statue of *Thomas H. Benton*, erected in St. Louis, Missouri, the *Sleeping Faun*, and a design of a memorial monument to Abraham Lincoln. In 1893 she completed her statue of *Queen Isabella of Spain*, ordered for the Columbian Exposition. Besides her skill in sculpture Miss Hosmer exhibited talents for designing and constructing machinery, and devising new processes, especially in connection with her own art, such as a method of converting ordinary Italian limestone into marble. She resided for many years in Rome, making occasional visits to the United States.

HOSMER, JAMES KENDALL, an American author; born in Northfield, Massachusetts, Jan. 29, 1834; was graduated at Harvard in 1855; professor at Antioch College, 1866-72; became professor of English and German literature in the University of Missouri in 1872; in 1874 became a professor in Washington University, St. Louis, Missouri. He published *The Color Guard* (1864); *Short History of German Literature* (1879); *Samuel Adams in the American Statesman Series* (1885); *The Life of Young Sir Henry Vane* (1888); *How Thankful Was Bewitched*, a novel (1895); and *The Life of Thomas Hutchinson* (1896).

HOSPINIAN, RUDOLPH, a Swiss theologian; born at Altdorf, Nov. 7, 1547; studied at Marburg and Heidelberg, and was pastor in the Swiss Reformed Church at different places. He wrote *The Strongholds of Christians* (1593); *Concordia Discors* (1609), which aroused the opposition of the Lutherans of Germany; and *History of the Jesuits* (1619), a portion of which was translated into English in 1678. He died March 11, 1626.

HOSPITALLERS, same as ST. JOHN, KNIGHTS OF. Vol. XXI, pp. 173-175.

HOSPODAR. See ROMANIA, Vol. XXI, p. 18.

HOST (Lat., *hostia*, "a victim"), the name given in the Roman Catholic church to the consecrated bread of the eucharist, so called in conformity with the doctrine of that church that the eucharist is a "sacrifice," in the strict sense of the word, though, in the common language of Roman Catholics, "host" is used for the unconsecrated altar-bread, and even so occurs in the offertory of the Roman missal. The host in the Latin church is a thin wafer of unleavened bread, made of the finest flour, and bearing upon it the figure of the Crucifixion or some other emblematic device. In all ancient liturgical rites the consecrated host was broken before being consumed by the priest. In the Roman church the celebrant first breaks it in two, and then from one half detaches a fragment which he drops into the chalice. In the Greek and other Oriental churches, as well as in various Protestant communities, the eucharist is celebrated in leavened bread. The use of unleavened bread is founded on the belief that Christ could only have used such bread when instituting the eucharist at the Paschal feast. Luther followed the Roman church on this point, but did not break the host. See EUCHARIST, Vol. VIII, pp. 650-654.

HOSTRUP, JENS CHRISTIAN, a Danish poet and dramatist; born in Copenhagen, May 20, 1818; studied theology at the University of Copenhagen; devoted himself to literature until 1855, in which year he entered the ministry and had charge of a pastorate until 1881, when he retired and returned to Copenhagen. His first literary work, a comedy, entitled *Opposite Neighbors*, was written while he was a student. It is still acted in Denmark. Several other comedies followed, among them *Intrigues* (1845); *Soldier Larks* (1850); and *Master and Apprentice* (1852). After entering the ministry he wrote but little, and that which he did produce was quite different in character from the rollicking comedies of his youth. Among these later works are *Songs and Poems* (1872); and *Eve*, a drama (1880). He died in January, 1893.

HOT-AIR ENGINE. See AIR-ENGINE, Vol. I, p. 428; and STEAM-ENGINE, Vol. XXII, pp. 522, 523.

HOT-AIR HEATING. See FURNACES, in these Supplements.

HOTBED. See HORTICULTURE, Vol. XII, pp. 225, 226.

HOTCHKISS, BENJAMIN BERKELY, an American inventor; born in Watertown, Connecticut, Oct. 1, 1826; became a machinist, and in 1856 designed a field-gun on a new pattern. In 1860 he submitted to the United States government an improved system of rifled projectiles, which was largely used during the Civil War. In 1867 he introduced his revolving cannon to the European governments, and afterward devised a magazine-rifle and a quick-firing gun. He died in Paris, Feb. 14, 1885.

HOT-HOUSE. See HORTICULTURE, Vol. XII, pp. 221-225.

HOT SPRINGS, a city and the capital of Garland County, western central Arkansas, 50 miles W.S.W. of Little Rock, on the Hot Springs railroad. A United States army and navy general hospital and a Roman Catholic school and convent are located here. In the vicinity valuable mines of gold, silver and lead are worked. Near the city are 72 thermal springs, some of which reach 150° F., and these are visited by large numbers of health-seekers. Population 1890, 8,086; 1900, 9,973.

HOT SPRINGS, a town of Madison County, western North Carolina, on the French Broad River and the Southern railroad, 30 miles N.W. of Asheville. It is beautifully situated on the east slope of the Smoky Mountains, near Bald Mountain, Painted Rocks, the Chimneys and Mount Cowbell. Its mineral springs and good hotels make it a very popular resort.

HOT SPRINGS, a village and the capital of Fall River County, southwestern South Dakota, on Fall Creek and on the Burlington and Missouri River railroad. It is the distributing and shipping point for a large mining district, and ships considerable live-stock. It also has a large lumber business and manufactories of stucco. It takes its name from the hot sulphated calcic-



sodic springs which are here. Population 1890, 1,423; 1900, 1,319.

**HOTTENTOT'S BREAD**, a kind of yam (*Tesudinaria elephantipes*), native of South Africa. See **ELEPHANT'S FOOT**, in these Supplements.

**HOUDIN, ROBERT**, a French conjurer; born at Blois in 1805. He studied mechanics, and after winning a medal for his toys and automata at the Paris exhibition of 1844, opened a series of exhibitions, which he continued for ten years, retiring in 1855 with a large fortune. In 1856, at the invitation of the French government, he went to Algeria and entered into competition with the miracle-working priests. He was completely successful, and did much toward destroying their influence. He published in 1857 his *Life*, and in 1859 a book entitled *Confidences*. He died at Blois in 1871.

**HOUGH, FRANKLIN BENJAMIN**, an American author; born at Martinsburg, New York, July 20, 1820. Graduated at Union College (1843); at Cleveland Medical College (1848); practiced medicine in Somerville, New York (1848-52), and in Albany (1852-60). When the Civil War broke out Hough enlisted, served nine months, and then settled in Lowville, New York, and devoted himself to scientific and literary pursuits. He published *History of St. Lawrence and Franklin Counties, New York* (1853); *History of Durryea's Campaign* (1864); *Washingtoniana* (1865); *American Biographical Notes* (1875). Also, translated *Badan's Guerre de Crimée*. He died June 6, 1885, in Lowville, New York.

**HOUGH, GEORGE WASHINGTON**, an American astronomer; born in Montgomery County, New York, Oct. 24, 1836; graduated at Union College in 1856, and turned his attention to astronomy. In 1860 he became astronomer at Albany, New York, and in 1879 was made director of Dearborn Observatory, Chicago. His principal scientific work was the cataloguing of double stars, more than three hundred different stars having been discovered by him, and catalogued. He invented a barograph and a thermograph, used in the United States Signal Service, and a printing-chronograph. Among his writings are *Annals of Dudley Observatory* (1866-71); *The Galvanic Battery* (1870); and *The Total Eclipse of August 7, 1869* (1870).

**HOUGHTON**, a village and the capital of Houghton County, northern North Michigan, on Lake Portage and on the Duluth, South Shore and Atlantic railroad, 68 miles N.W. of Marquette. It is the center of the Lake Superior copper-mining district, the richest copper-producing region in the country. In 1891 this district yielded 114,222,709 pounds, or over two fifths of the entire product of the United States. Population 1900, 3,359.

**HOUGHTON, HENRY OSCAR**, an American publisher; born at Sutton, Vermont, April 30, 1823. Was apprenticed to a printer in Burlington, Vermont; afterward entered the University of Vermont, and graduated in 1846; for a time was reporter on the *Boston Traveller*; in 1849 estab-

lished a printing-office in Cambridge, Massachusetts, the successor to which is the Riverside Press; established the publishing-house of Hurd and Houghton in 1864; in 1878 the firm of Houghton, Osgood and Company, which was changed in 1880 to Houghton, Mifflin and Company, its present name. He died Aug. 26, 1895, in North Andover, Massachusetts.

**HOUGHTON, RICHARD MONCKTON MILNES, LORD**, an English author, born at Pontefract, June 19, 1809. He was educated at Cambridge, graduating in 1831. From 1837 to 1863 he represented Pontefract, first as a Conservative, but afterward as an Independent Liberal. In 1863 he was raised to the peerage. He championed oppressed nationalities, liberty of conscience and the rights of women; and secured the passage of a bill for the establishment of reformatories. He was a patron of men of letters, and a man of letters himself. He was said to have secured the laureateship for Tennyson, and to have been the first to recognize the genius of Swinburne. Among his works are *Memorials of a Town in Greece* (1833); *Poems of Many Years* (1838); *Life, Letters and Remains of Keats* (1848); *Monographs* (1873); and *Collected Poetical Works* (1876). He died at Vichy, Aug. 11, 1885.

**HOULTON**, a town and the capital of Aroostook County, northeastern Maine; on the Canadian Pacific and the Bangor and Aroostook railroads. The chief productions of the vicinity are potatoes, hay, starch, cedar shingles and hemlock bark. The Ricker Classical Institute (Baptist) is situated here. Pop. 1890, 4,015; 1900, 4,686.

**HOUMA**, a post village, capital of Terre Bonne Parish, southern Louisiana, on a branch of the Texas and Louisiana railroad, 70 miles S.W. of New Orleans. It has a convent and an academy. It is in an agricultural region, and manufactures sugar and molasses, and exports these products, and also rice and corn. Population 1900, 3,212.

**HOUND-FISH**. See **SHARK**, Vol. XXI, p. 774.

**HOUR-GLASS**, a device for measuring time (properly of one hour of time) by means of the passage of a given amount of fine sand through a small opening. It generally consists of two glass bulbs, one of which is partially filled with dry sand, of the same size and shape, joined by a narrow passage-way. The instrument is by no means accurate, as the sand is liable to become damp, and the bulbs and the passage-way joining them are subject to contraction and expansion on account of changes of temperature. There are also half-hour glasses, three-minute glasses, etc., which are often called hour-glasses. The hour-glass is said to have been invented in Alexandria in the third century, A. D., and at first was



HENRY O. HOUGHTON.

carried about as are watches nowadays. After the Reformation, hour-glasses were placed in many of the churches and used by the preachers to time their sermons, and even until recently in some out-of-the-way churches they have formed a part of the regular pulpit furniture.

HOURI, according to the Koran, a nymph of Paradise, whose companionship after death is to be one of the great felicities of the true believers. The houris are not of flesh and blood, but are composed of musk, incense, saffron and amber, and are gifted with immortal youth and charms that never lessen. Each Moslem is to possess 72. With the more cultured Mohammedans, however, the promised delights of these heavenly virgins are considered as allegories, picturing the spiritual happiness of the blessed.

HOURS. See CALENDAR, Vol. IV, p. 664.

HOUSATONIC RIVER, a river of western Connecticut and Massachusetts, which rises in the latter state, in Windsor Township, Berkshire County; follows a southerly course through Connecticut amid beautiful, wild scenery, and enters Long Island Sound, 13 miles S.W. of New Haven, after a course of 150 miles. Tide-water ascends the river for 14 miles.

HOUSE, EDWARD HOWARD, an American author; born in Boston, Sept. 5, 1836. From 1850 to 1853 he studied music; was part proprietor and musical and dramatic critic of the Boston *Courier* (1854-58); dramatic and musical critic on the New York *Tribune* (1859-70); special correspondent in Japan for the New York *Herald* (1874-76); professor of English language and literature at the University of Tokio, Japan, 1871-73. He was influential in securing the return, in 1882, of the indemnity paid by the Japanese government to the United States on account of the Simonoseki affair. He published *The Simonoseki Affair* (1874); *The Japanese Expedition to Formosa* (1875); *Japanese Episodes* (1881); *Yone Santo* (1888); *The Midnight Warning* (1893).

HOUSEMAID'S KNEE, the term commonly applied to an acute or chronic inflammation of the bursa or sac between the knee-pan and the skin. Housemaids were considered especially liable to it from their kneeling to scrub on hard floors. In its acute form it causes considerable pain, swelling and febrile disturbance, the swelling being very superficial and in front of the patella.

HOUSE OF COMMONS. See PARLIAMENT, Vol. XVIII, pp. 302-313.

HOUSE OF CORRECTION, a house established by law as primarily a place of confinement and discipline for incorrigible children who are not of sufficiently mature age that the law will permit them to be imprisoned in a jail. The laws regulating houses of correction vary in the different states, but generally it may be said that dependent or incorrigible children may be sent there for maintenance and discipline, and those who have committed felony, for punishment. In some states any one under 21 years of age may be sent to the house of correction instead of to jail or the penitentiary, at the discretion of the

court, when the offense of which he is convicted is slight, and it appears to the court that the youth may thus be redeemed from the criminal class.

HOUSSAYE, ARSÈNE, a French litterateur; born at Bruyères, March 28, 1815. He went to Paris, and in 1836 made his début into the literary world with two novels, *La Couronne de Bluets* and *La Pécheresse*. The friendship of Jules Janin and of Gautier, together with the collaboration of Sandeau, aided him to gain recognition. From 1844 to 1849 he was editor of the *Artiste*, and in 1861 became editor of the *Presse*. In 1849, through the influence of Mlle. Rachel, he was given the direction of the Comédie Française, which he held until 1856. During his administration the theater, which had been heavily in debt, was put upon a sound financial footing. He was decorated with the Legion of Honor in 1846, and made officer in 1858. Among his works are *Philosophes et Comédiennes* (1850); *Les Parisiennes* (1869); *Les Femmes du Diable* (1876), novels; *Poésies Complètes* (1851); *L'Histoire du Quarante et Unième Fauteuil de l'Académie Française* (1855); *Le Roi Voltaire* (1858); *L'Histoire de la Peinture flamande et hollandaise* (1846); *Confessions, Souvenirs d'un Demi-Siècle* (1891). He died in Paris, Feb. 26, 1896.

HOUSTON, a village and one of the capitals of Chickasaw County, northeastern Mississippi, on Hoolka Creek, 29 miles N.W. of West Point. The region produces cotton, corn, vegetables and live-stock. It has a normal school. Population 1890, 893; 1900, 677.

HOUSTON, a village and the capital of Halifax County, central southern Virginia, on Banister River and the Southern and the Norfolk and Western railroads, 48 miles S.S.E. of Lynchburg. It is the shipping-point for tobacco and stock, raised extensively in the vicinity, and has furniture and tobacco factories. Population 1890, 1,285.

HOUSTON, a city and the capital of Harris County, southeastern Texas. (See HOUSTON, Vol. XII, p. 318.) It is situated on eleven railroads, the most important of which are the Gulf, Colorado and Santa Fé, the International and Great Northern, the Missouri, Kansas and Texas and the Southern Pacific. Its importance in manufacturing has grown very much in the past few years. Its industries have a capital of \$3,500,000 and produce \$6,700,000 worth of products per annum; there is employed an average number of 3,000 men. These industries include oil-refining, brewing, cotton-baling, car-wheel making, furniture making, car repairing and building, three railroads having shops here. Its growth, however, is mostly due to its commercial advantages. It ships large quantities of the cotton and maize raised so extensively throughout the state, and considerable other farm and manufacturing products. The city suffered considerably from the cyclone which proved so destructive to Galveston September 8, 1900. Population 1890, 27,557; 1900, 44,633.

HOUSTON, DAVID CRAWFORD, an American military engineer; born in New York city, Dec. 5,

1835; graduated at West Point in 1856, and remained at the academy for a year as assistant professor; in 1857 was engaged in engineering work at Hampton Roads, and later at Sandy Hook. During the Civil War he served as engineer and received the brevet of colonel. After the war he continued his work as engineer, and in 1886 was made member of the board of engineers for fortifications and river and harbor improvements. He was made colonel in 1889. He died May 18, 1893.

HOUTZDALE, a post village of Clearfield County, western central Pennsylvania, on the Pennsylvania railroad, 15 miles S. of Clearfield. It has a lumber-mill, and much bituminous coal is mined in the vicinity. Population 1900, 1,482.

HOVELAQUE, ABEL, a French anthropologist; born in Paris, Nov. 14, 1843. He was one of the most industrious of the younger school of French scientists; from his early youth devoted himself largely to the study of anthropology, and became a prolific writer on topics connected with this branch of science. At the age of 23 he founded the *Revue Linguistique*, the first journal in France devoted to linguistics. From 1876 to 1890 he was professor of linguistic ethnology at the *École d'Anthropologie*, becoming its president in 1890. He was a member of the Anthropological Society, and as such published many articles in the periodicals, chiefly on cranial investigations, etc. Among his more important works are *Grammar of the Zend Language* (1869); *Our Ancestor*, a work on the beginnings of mankind (1877); *Languages, Races and Nationalities*; *The Avesta Zoroaster and Mazdeism* (1880); *The Negroes of Equatorial Africa* (1889); etc. He died in Paris. Feb. 22, 1896.

HOVENDEN, THOMAS, an Irish-American artist; born in Dunmanway, Cork Co., Ireland, Dec. 28, 1840. He received his early art education at the School of Design in Cork; went to New York in 1863, and studied at the National Academy; went to Paris in 1874, and studied under Cabanel and in the *École des Beaux-Arts*; returned to the United States in 1880; in 1882 was elected to the National Academy. Among his most noteworthy pictures are *The Two Lilies* (1874); *Pleasant News* (1876); *Loyalist Peasant Soldier of La Vendée* (1878); and *Breaking the Home Ties*, one of the most popular pictures at the World's Columbian Exposition, 1893. Died at Plymouth Meeting, near Norristown, Pa., Aug. 14, 1895.

HOVERING ACTS, a popular term rather than a legal appellation used to describe that class of legislative enactments by which any nation assumes control over the waters surrounding its shores for a distance greater than the usual and conventional marine league. England passed such a law in 1736 for revenue purposes, and thereby prohibited the transshipment of foreign and dutiable merchandise within four leagues of the coast. The United States Congress passed a similar statute in 1797, which provides for a forfeiture of the cargo of any vessel offending. While these essentially municipal statutes have received judicial sanction and indorsement, their

international standing is based on the acquiescence of nations affected by them and on comity of nations, rather than founded on any abstract legal right.

HOVEY, ALVAH, an American clergyman; born in Greene, New York, March 5, 1820. Graduated at Dartmouth in 1844; at the Newton Theological Institution in 1848; in 1848-49 was pastor of the Baptist church in New Gloucester, Maine, and from 1849 to 1855 was instructor, and from 1855 to 1868 held a professorship in Newton Theological Institution. In 1868 he was chosen president of the seminary. Among his writings are *The State of the Impenitent Dead* (1859); *The Miracles of Christ as Attested by the Evangelists* (1864); *The Scriptural Law of Divorce* (1866); *God with Us: or, the Person and Work of Christ* (1872); *Studies in Ethics and Religion* (1892); and he edited *The American Commentary on the New Testament* (1881-90).

HOVEY, ALVIN PETERSON, an American soldier; born at Mount Vernon, Indiana, Sept. 6, 1821; was apprenticed to a brickmaker, but studied law, and was admitted to the bar in 1843; received commission of first lieutenant in Mexican War; in 1851 was circuit judge of Indiana; entered the Union army in 1861 as colonel; made brigadier-general of volunteers, 1862; brevetted major-general, 1864; resigned in 1865 and was minister to Peru, 1865-70; in 1886 elected to Congress; governor of Indiana, 1888-90. He died in Indianapolis, Nov. 23, 1891.

HOVEY, CHARLES MASON, an American horticulturist; born in Cambridge, Massachusetts, Oct. 26, 1810. He edited the *American Gardener's Magazine* (1835); the *Magazine of Horticulture* (1835-69); and published *Fruits of America* (1854), the best work on the subject in its time. He was president of the Massachusetts Horticultural Society (1863-67). His grounds at Cambridge contained 168 specimens of trees. He died Sept. 2, 1887, in Cambridge, Massachusetts.

HOWARD, a city and the capital of Elk County, southeastern Kansas, on Elk River and the Atchison, Topeka and Santa Fé railroad, 60 miles E. S. E. of Wichita. It is in a farming and grazing district. It has a cigar factory. Population 1900, 1,207.

HOWARD, BLANCHE WILLIS. See TEUFEL, MRS., in these Supplements.

HOWARD, BRONSON, an American dramatist, was born in Detroit, Michigan, Oct. 7, 1842. After a preparatory school education, he went into journalism in New York, but in 1870 the success of his first play, *Saratoga*, determined his career. He produced, in rapid succession, *Diamonds* (1872); *Hurricanes* (1878); *The Banker's Daughter* (1878); *Wives* (1879); *Young Mrs. Winthrop* (1882); *One of Our Girls* (1885); *Met by Chance* (1887); *The Henrietta* (1887); *Shenandoah* (1889); and *Aristocracy* (1892)—all of which have been received with favor, and some of which have been reproduced in England. From 1875 on, Mr. Howard resided in New York and London.

HOWARD, CATHERINE, an English queen, the

fifth wife of Henry VIII of England; born in 1521, the daughter of Edmund Howard, son of the Duke of Norfolk. Henry was divorced from his fourth wife, July 9, 1540, and on the 28th of the same month married Catherine. At first the marriage was happy; but after a time the king's suspicions were aroused by stories concerning her life previous to the marriage, which led him to make investigation of her conduct after it. As a result, she was arraigned on the accusation of adultery, convicted, and, after a full confession before the House of Lords, was executed Feb. 13, 1542.

HOWARD, EDWARD, an English cardinal priest of the Roman Catholic Church, was born at Nottingham, England, Feb. 13, 1829. In his youth he served as an officer in the Second Life Guards, but when 26 years old became a priest; was consecrated archbishop of Neo-Cæsaria, *in partibus infidelium*, in 1872; created a cardinal priest by Pope Pius IX, March 12, 1877; in December, 1881, was nominated archpriest of the basilica of St. Peter's. Cardinal Howard's attainments as a linguist were remarkable. He spoke Arabic, Armenian and Russian fluently, besides the languages of western Europe. He died in Brighton, England, Sept. 18, 1892.

HOWARD, JOHN EAGER, an American soldier and statesman; born in Baltimore County, Maryland, Jan. 4, 1752. He fought in the battle of White Plains, New York, 1776, as captain in a Maryland regiment, and in 1777 distinguished himself at Germantown, where he commanded a regiment. At the battle of Cowpens, Jan. 17, 1781, Colonel Howard commanded the Continentals, and led them in a bayonet charge which decided the fortunes of the day. At Eutaw Springs he was severely wounded. After the war he was in Congress from 1787 to 1788, and governor of Maryland from 1789 to 1792. From 1795 to 1803 he was United States Senator from Maryland. He died in Baltimore, Oct. 12, 1827.

HOWARD, OLIVER OTIS, an American general; born at Leeds, Maine, Nov. 8, 1830. After graduating at Bowdoin College in 1850 and at West Point in 1854, he was made instructor in mathematics in the military academy. In 1861 he became colonel of a regiment of Maine volunteers; and at the battle of Bull Run, July 21st, of the same year, commanded a brigade, and was soon after made brigadier-general. At the

battle of Fair Oaks, June 1, 1862, he lost his right arm. General Howard took part in the battles of Antietam, Chancellorsville, Gettysburg, Lookout Valley, Missionary Ridge, Chattanooga; commanded the right wing of Sherman's army during its march to the sea and through the Carolinas; was made commissioner of the Freedmen's

Bureau, May 12, 1865, and held that office until June 30, 1872, when it was closed. In 1869 he was made president of Howard University, which had been established in Washington for the higher education of the negroes, but resigned in 1873. In 1877 he conducted a campaign against the Nez Percés Indians, and pursued them for thirteen hundred miles, as related in his book, *Chief Joseph*. He also defeated the Bannacks and Piutes in 1878. In March, 1886, he was promoted to be major-general, and succeeded General Hancock in command of the Division of the Atlantic. He retired in 1894.

HOWARD ASSOCIATION was founded in 1866, under the patronage of Lord Brougham, to promote the best methods of treatment and prevention of crime and pauperism. The principles of John Howard, the philanthropist, have shaped the policy of the association as a rule. It collects information at home and abroad bearing on the present systems of punishment and prevention of crime, and publishes this information from time to time in pamphlets. Its secretary, William Tallack, is the author of a book, *Penological and Preventive Principles* (second edition 1895), which has received high official recognition.

HOWARD CITY, a post-village and railroad junction in Montcalm County, central south Michigan, 33 miles N. of Grand Rapids, on the Detroit, Lansing and Northern and the Grand Rapids and Indiana railroads. Here furniture, butter tubs lumber and shingles are manufactured. It is surrounded by rich farm lands; wheat and potatoes are the principal crops. Population 1900, 1,398.

HOWARD UNIVERSITY, an institution of learning established in Washington, District of Columbia, in 1867, with the object of giving to the emancipated slaves opportunities of obtaining a liberal and professional education. The university consists of academical, theological, law, normal, medical, dental and pharmaceutical departments; is non-sectarian, and admits students without respect to sex or color. The number of instructors in 1895 was 56, the number of pupils 587. There were 13,000 books in the library. The annual income was \$60,000. Tuition is free. The institution was named after General Oliver Otis Howard, who at the time of its foundation was at the head of the Freedmen's Bureau.

HOWE, EDGAR WATSON, an American author and journalist; born in Wabash County, Indiana, May 3, 1854. He received no school education after his ninth year, but was apprenticed to a printer. In 1878 he became proprietor and editor of the Atchison *Daily Globe*, of Atchison, Kansas. He published *The Story of a Country Town* (1883); *The Mystery of the Locks* (1885); *A Moonlight Boy* (1886); and *A Man Story* (1887).

HOWE, ELIAS, an American inventor; born at Spencer, Massachusetts, July 9, 1819. While working in a machine-shop at Lowell, Massachusetts, and afterward in one at Boston, he developed his invention of the sewing-machine, and, having constructed the first machine in May,



GEN. O. O. HOWARD.

1845, obtained a United States patent Sept. 10, 1846. He tried in vain to introduce his invention in England. On his return to Boston in 1849 he found that his patent had been infringed. For seven years he had to litigate to protect his patent rights, until the principal manufacturers, after being defeated in the courts, agreed to pay him royalties on the sewing-machines made by them. His yearly income from this source increased to \$200,000, and the total fortune derived from his invention amounted to \$2,000,000. He received, among other marks of distinction, the cross of the Legion of Honor of France. He died in Brooklyn, New York, Oct. 3, 1867.

HOWE, JOSEPH, a Canadian statesman; born in Halifax, Dec. 13, 1804. He was originally a printer. In 1828 he became editor and proprietor of the *Nova-Scotian*; in 1836 elected to Parliament; in 1840 a member of the provincial cabinet, but resigned in 1854 to superintend the construction of the first railroad in Nova Scotia; in 1863 became premier of the province. He opposed the absorption of Nova Scotia by the Dominion at first, but afterward obtained the best terms for his province, and accepted a place in the Dominion cabinet in 1869. In 1873 he was appointed lieutenant-governor of Nova Scotia. He died in Halifax, June 1, 1873.

HOWE, JULIA WARD, an American poetess; wife of Dr. Samuel Gridley Howe; born in New



JULIA WARD HOWE.

York City, May 27, 1819. She took a deep interest in her husband's philanthropic labors, and was associated with him in editing the *Commonwealth*, an anti-slavery magazine. At the New Orleans World's Fair in 1885, Mrs. Howe was the chief of the women's department. She published *Passion Flowers* (1854); *Words for the Hour* (1856); *The World's Own* and *Hippolytus*, two tragedies; *Later Lyrics* (1866); and also a work entitled *Modern Society* (1881), and a *Life of Margaret Fuller* (1883). The most memorable of her poems is the *Battle Hymn of the Republic*. Mrs. Howe was a zealous worker in the cause of woman suffrage.

HOWE, SAMUEL GRIDLEY, an American philanthropist; born in Boston, Nov. 10, 1801. After studying medicine he went to Greece in 1824, where he was placed at the head of the surgical service in the war for independence. In 1831 he went to Europe again to inspect schools for the blind, and upon his return in 1832 started a school for the blind in Boston, which afterward was known as the Perkins Institution. Dr. Howe was made superintendent, and held the office until his death. His greatest success was in the education of Laura Bridgman. He also assisted in founding a school for training idiots, which was organized as the Massachusetts School for Idiots. In 1871 he was sent by President Grant as a member of

the commission to visit San Domingo and report upon the advisability of its annexation to the United States. Dr. Howe published a *Historical Sketch of the Greek Revolution* (1828), and a *Reader for the Blind* (1839). His widow has written his biography. He died in Boston, Jan. 9, 1876.

HOWE, TIMOTHY OTIS, an American jurist and statesman; born in Livermore, Maine, Feb. 24, 1816. He was admitted to the bar in 1839; elected to the state legislature of Maine in 1840; moved to Green Bay, Wisconsin; in 1850 was elected judge in the circuit and supreme court of Wisconsin; in 1861 was elected to the United States Senate, and served until 1879; in 1881 was made Postmaster-General in Arthur's Cabinet. He died in Kenosha, Wisconsin, March 25, 1883.

HOWE, WILLIAM, VISCOUNT, an English general; brother of Admiral Howe; born Aug. 10, 1729; was educated at Eton, and joined the army; served under General Wolfe at Quebec; made colonel (1764); major-general (1772); commander-in-chief of the British forces in America in 1775, after General Gage's departure and until superseded by Clinton in 1778. (See UNITED STATES, Vol. XXIII, pp. 741-743.) Upon his return to England his conduct was upheld by Parliament after investigation, and he was made lieutenant-general in 1782; general, 1786; succeeded to the Irish peerage, 1799. He died July 12, 1814.

HOWELL, a village and the capital of Livingston County, southeastern Michigan, on the Detroit, Lansing and Northern railroad, 32 miles E. of Lansing. It is in an agricultural section; has foundries and machine-shops; and manufactures flour, condensed milk, sashes and doors. Population 1890, 2,387; 1900, 2,518.

HOWELL, JOHN CUMMING, an American naval officer; born in Philadelphia, Nov. 24, 1819; entered the navy as midshipman (1836); became lieutenant (1849); commander (1862); served in the North Atlantic blockading squadron in 1861; in the East Gulf squadron (1862-63), and again in the North Atlantic squadron in 1864-65; was fleet-captain of the European squadron (1868-70); commandant of the League Island navy-yard, at Philadelphia (1870-72); commissioned commodore (1872); commandant of the Portsmouth, N. H., navy-yard (1872-74); chief of the bureau of yards and docks (1874-78). He was made rear-admiral in 1877, and retired in 1881. Died in Folkestone, Eng., Sept. 12, 1892.

HOWELLS, WILLIAM DEAN, an American novelist; born at Martin's Ferry, Ohio, March 1, 1837. His father was the proprietor and publisher of several newspapers in Ohio, and he received his education in a printing-office. In 1851



WILLIAM D. HOWELLS.

he was compositor on the *Ohio State Journal*, and afterward in the same year worked on his father's latest venture, the *Ashtabula Sentinel*, which subse

quently was moved to Jefferson. In 1859 he was taken on the staff of the *State Journal*; and when Lincoln was nominated in 1869 Howells wrote his life, and received \$160 for the work, which enabled him to take a trip to Boston. Here he became acquainted with Lowell, Holmes and others. Previous to this he had published several poems in the *Atlantic Monthly*. In the following year he was appointed consul at Venice, where he remained until 1865, studying the Italian language and literature. The result of his residence there was the publication of his *Venetian Life* (1866) and *Italian Journeys* (1867), which first made known to the world his power of observation and his charm of style as a prose-writer. After his return home he was for a time on the staff of the *New York Tribune*, then of the *Times*, and in 1866 was made assistant editor of the *Atlantic Monthly*. Six years later he became its editor, a position which he held until 1881. In 1882-83 he made a second trip to Europe, and in 1886 took charge of the *Editor's Study* of *Harper's Monthly*, contributing to it a series of critical papers on contemporary literature, American and foreign, in which he defended the literary doctrines of the modern realists. In 1892 he was editor of the *Cosmopolitan*, but after that time devoted himself entirely to literary production. His works include *Their Wedding-Journey* (1871); *Poems* (1873); *A Chance Acquaintance* (1874); *A Foregone Conclusion* (1875); *The Lady of the Aroostook* (1879); *A Modern Instance* (1882); *The Rise of Silas Lapham* (1885); *Modern Italian Poets* (1887); *The Quality of Mercy* (1892); *On the Coast of Bohemia* (1893); *A Traveler from Altruria* (1894); *My Literary Passions* (1895); *Stops of Various Quills* (1895); *A Parting and a Meeting* (1896); and *The Day of Their Wedding* (1896). Besides the above he wrote several autobiographical sketches, and a number of parlor-farces remarkable for their elegant dialogue and subtle humor. Among these farces are *The Parlor-Car*; *The Sleeping-Car*; *The Elevator*; *Five O'Clock Tea*; *The Garroters*; *A Likely Story*; and *The Mousetrap*.

Mr. Howells professes to be a realist, and is an admirer of the modern school of poets and novelists in Europe, and especially the writers of Russia, Italy and Spain, many of whom he has made known in America by his critical works. As a novelist, he has a charming style, keen observation, and sympathetic humor. His realism, it may be stated, is not that of Balzac, Zola, or even of Ibsen, which often is degrading and horrifying instead of educational and improving, but is cleanly and uplifting in tendency. His realism is distinctly American, and his own, and the intelligent critic, or even ordinary reader, will never confound it with the noisome stuff which is called realism in the purlieus of Europe.

HOWLAN, GEORGE WILLIAM, a Canadian statesman; born in Waterford, Ireland, May 19, 1835. He emigrated to Prince Edward Island in 1839; was educated at the Central Academy there; became interested in the fishing trade; member of the executive council of the province in 1866; in 1873 deputy to the Dominion Parliament to settle

terms for union; in 1873 called to the Senate; resigned 1880, but was recalled in 1881.

HOWLAND, SIR WILLIAM PIERCE, a Canadian statesman; born at Pawling, New York, May 29, 1811. Moved to Toronto in 1830 and went into mercantile business; member of the Canadian Assembly (1857-68); Minister of Finance, (1862-63 and 1866-67); receiver-general (1864-65); Postmaster-General (1864-66); member of the Dominion Parliament (1867-68); lieutenant-governor of Ontario (1868-73); knighted (1879). For a time he was president of the Board of Trade of Toronto.

HOWITT, MARY. See Vol. XII, pp. 324, 325.

HOWITZER. See GUNNERY, Vol. XI, pp. 306, 310.

HOWLING MONKEY. See APE, Vol. II, pp. 153, 154.

HOWMAN, JOHN. See FECKENHAM, Vol. IX, p. 61.

HOWORTH, HENRY HOYLE, an English littérateur; born July 1, 1842, at Lisbon, Portugal. He was educated at the Rossall School, and admitted to the bar in 1867; elected to Parliament from South Salford in 1886, in 1893, and again in 1895. He published the *History of the Mongols* (1876-80), a work still in progress; *A History of Chinghiz Khan and His Ancestors*, based upon a newly discovered work in the Pekin library; *The Mammoth and the Flood* (1887); *The Glacial Nightmare and the Flood*; and *History of the Vicars of Rochedale*.

HOWSON, JOHN SAUL, an English theologian; born in Yorkshire, May 5, 1816; graduated at Trinity College, Cambridge, in 1837; ordained in 1845; principal Liverpool College (1849-65); vicar of Wisbech (1866-67); dean of Chester from 1867 till his death. He was the author of *Life and Epistles of Paul*, with W. J. Conybeare (1850-52); *Character of St. Paul* (1862); *Companions of St. Paul* (1871); *Evidential Value of the Acts of the Apostles*, first delivered as lectures in Philadelphia (1880). He spent the latter part of his life superintending the restoration of Chester Cathedral. He died Dec. 15, 1885.

HOYA, a genus of tropical plants of the family *Asclepiadaceæ*, having a five-cleft wheel-shaped corolla, and a five-leaved spreading fleshy corona. Some of the species are common in hothouses, notably *H. carnosa*, and from the appearance of their flowers they are called *wax-plants*.

HOYT, CHARLES II., an American playwright; born in Concord, New Hampshire, July 26, 1860; received his education at the high school of Charlestown, New Hampshire, and at the Boston Latin School; began newspaper-life at an early age, and succeeded Benjamin P. Shillaber as the humorous writer of the *Boston Post* in 1879. While doing this work and the dramatic criticism of the *Post*, he began to write plays, the first one being *Gifford's Luck*, which was put upon the stage in 1882. This was followed by *A Bunch of Keys* (1883); *A Rag Baby* (1884); *A Parlor Match* (1884); *A Tin Soldier* (1885); *A Hole in the Ground* (1887); *A Midnight Bell* (1887); *A Brass Monkey* (1888); *A Texas Steer* (1889); *A Trip to Chinatown* (1889); *A Temperance Town* (1891);

*A Milk-White Flag* (1893); *A Black Sheep* (1894); *A Contented Woman* (1895). Mr. Hoyt was something of a politician also, having been a member of the New Hampshire legislature in 1893 and 1895. He was one of the proprietors of Hoyt's Theater, in New York.

HOYT, JOHN WESLEY, an American educator; born in Franklin County, Ohio, Oct. 13, 1831. He was educated at the Ohio Wesleyan University, the Cincinnati Law School and the Ohio Medical College; made professor in the latter in 1853; professor at Antioch in 1855-56; in 1857 accepted the chair of chemistry in the Cincinnati College of Medicine; moved to Wisconsin, and was editor of the *Wisconsin Farmer* (1857-67); United States Commissioner to the Paris Exposition in 1867 and to the Vienna Exposition in 1873; knighted in 1874 by the Emperor of Austria; governor of Wyoming territory 1878-82; elected president of Wyoming University in 1887.

HUACAS, tombs of the Incas. See ARCHÆOLOGY, Vol. II, p. 340.

HUACHUCA, FORT, a United States military post, having a post-office and telegraph station of the same name, in the department of the Colorado, situated about 15 miles from the Mexican boundary, in a mountainous district of Cochise County, south-eastern Arizona. It is reached by daily buckboard from Huachuca, seven miles distant, on the New Mexico and Arizona railroad. The post is garrisoned by several companies of infantry and cavalry, whose principal duty it is to prevent outbreaks on the part of the warlike Apaches.

HUALLAGA, a river of Peru, rising in a swamp in the Huánuco district, in the cordillera of Peru, about the center of the republic. It flows northward through a heavily timbered and very rainy region, and makes it way, after a crooked course of over seven hundred miles, to the Marañon or Amazon River, which it joins at lat 5° 6' 20" S., long. 75° 34' 50" W. It is navigable for river-steamers for 285 miles, and canoes can ascend it 40 miles farther, to Tirgo Maria. During its annual floods, the water sometimes rises forty feet above its usual level.

HUAMANTLA, a town of the state of Tlascala, southeastern central Mexico, on the north slope of Mount Malintzi, 13,500 feet high, surrounded by magnificent scenery, in a very pleasant climate. It is connected with the City of Mexico by rail, and is about a hundred miles east of it. The country is rich, and produces principally maize. On Oct. 9, 1847, the Americans defeated the Mexicans here. Population, about 8,000.

HUAMANGA. See AYACUCHO, Vol. XVIII, p. 675.

HUBBARD, JOSEPH STILLMAN, an American astronomer; born in New Haven, Connecticut, Sept. 7, 1823. He graduated at Yale in 1843; studied astronomy and mathematics privately; in 1844 was appointed assistant at the high school observatory at Philadelphia; and was employed by John C. Frémont to edit his Rocky Mountain observations. In 1845 he was appointed professor of mathematics in the United States navy, and assigned to duty in the observatory in Washington. Here he made de-

terminations of the zodiacs of all known asteroids, except four published previously in Germany. Several of his papers on the results of different investigations were published under the name of *Washington Observations*. He died at New Haven, Aug. 16, 1863.

HUBBARD, WILLIAM, an American clergyman and historian; born in England in 1621. He emigrated with his parents to America in 1635; graduated at Harvard in 1642; was first assistant, then pastor, at Ipswich until 1703. He published *The Present State of New England* (1677); *Memoirs of Major-General Denison* (1684); *The General History of New England from the Discovery to 1680*. The government of Massachusetts paid him fifty pounds for the latter. It was reprinted for the Massachusetts Historical Society in 1815. He died in Ipswich, Sept. 14, 1704.

HUBERTSBURG, a village and castle, formerly a royal hunting-seat of Saxony, 25 miles from Leipsic, built in 1721 by Prince Frederick Augustus, afterward King Augustus III of Poland. It was much injured during the Seven Years' War; and there, Feb. 15, 1763, was signed the treaty by which that war was ended. Since 1840 the castle has served as a prison, a hospital, an asylum for the insane, and a refuge for idiot children.

HÜBNER, JOSEPH ALEXANDER, BARON, an Austrian diplomat; born in Vienna, Nov. 26, 1811. He was educated in Vienna, subsequently traveled in Italy, and on his return in 1833 entered the service of the government. His diplomatic career began at Paris in 1837. After several minor appointments, he was ambassador there from 1849 to 1859, and was at the head of the Austrian embassy at Rome from 1866 to 1867. Possessed of consummate ability and tact, he managed many delicate and difficult matters. He twice visited the United States, the second time in 1871. He published *Sixtus der Fünfte* (1871); *Ein Spaziergang um die Welt* (1873); and *Durch das Britische Reich* (1886). His works have been translated into English. He died July 30, 1892.

HÜBNER, RUDOLF JULIUS BENNO, a German painter; born at Oels, in Silesia, Jan. 27, 1806. He studied at Düsseldorf, to which school of painting he belonged. In 1841 he was appointed professor of painting in the academy at Dresden, and was director of the picture-gallery from 1871 to 1882. Among his pictures are *Job and His Friends*; *Charles V in San Yuste*; *Frederick the Great in Sans Souci*; *The Golden Age*; and *The Dispute between Luther and Dr. Eck*. He also designed glass-paintings, including some for the crypt of Glasgow Cathedral. He died at Loschwitz near Dresden, Nov. 7, 1882.

HÜBSCHMANN, JOHANN HEINRICH, a German philologist; born at Erfurt, July 1, 1848; educated at Jena, Tübingen, Leipsic and Munich; private instructor at Leipsic, and later was professor at Strasburg. He published *Zur Casuslehre* (1875); *Iranische Studien*; and *Grundzüge der Armenischen Etymologie* (1883); *Das Indogermanische Vocalsystem* (1885); *Etymologie und Lautlehre der Ossetischen Sprache* (1887).

HUCKLEBERRY, a name applied primarily to

the berries of *Gaylussacia*, the American whortleberry, but extended to include those of certain species of *Vaccinium*, otherwise the blueberries. Both the genera are shrubs of the family *Ericaceæ*, or heaths, and are distinguished from the heaths proper by the inferior ovary, a distinction which many regard as sufficient to separate them as a distinct family (*Vacciniaceæ*). *G. resinosa* is the common black huckleberry, while *V. Pennsylvanicum*, *V. Canadense*, *V. vacillans* and *V. corymbosum* furnish the more pulpy and blue huckleberries. Very large quantities are collected for the market, and attempts are being made to bring them into cultivation. See **BILBERRY**, in these Supplements.

**HUDSON**, a post village of southwestern Middlesex County, Massachusetts, 17 miles N.E. of Worcester, on the Assabet River, and on the Boston and Maine and the Fitchburg railroads. Shoes, worsteds, gossamer-rubber and tanned leather are manufactured. Population 1900, 5,454.

**HUDSON**, a village of Lenawee County, southeastern Michigan, on Tiffin River, and on the Cincinnati, Jackson and Mackinaw and the Lake Shore and Michigan Southern railroads, 26 miles S. of Jackson. It manufactures butter-tubs, spokes, carriages, pumps, plows, evaporated fruit and creamery products. A sanatorium is situated here, and there are mineral springs. Population 1900, 2,403.

**HUDSON**, a city and the capital of St. Croix County, western Wisconsin, on St. Croix River, 18 miles E. of St. Paul, Minnesota. It contains wheat-warehouses, flour-mills, saw-mills, railroad repair-shops, breweries, machine-shops, and manufactories of plows, wagons, chairs and other furniture, and brooms. Population 1895, 3,338.

**HUDSON**, CHARLES THOMAS, an English microscopist; born in London, in 1828. He entered St. John's College, Cambridge, in 1848, and was fifteenth wrangler in 1852. He was president of the Royal Microscopical Society in 1888, 1889 and 1890, and elected a fellow of the Royal Society in 1889. He was joint author, with P. H. Gosse of Hudson and Gosse's *Rotifera*, and was the discoverer of *Pedalion mirum*, and of numerous new genera and species of *Rotifera*.

**HUDSON**, ERASMUS DARWIN, an American surgeon; born in Torrington, Connecticut, Dec. 15, 1805; graduated at the Berkshire Medical School in 1827; from 1837 to 1849 was lecturing-agent for the Connecticut Antislavery Society; received an appointment from the government during the Civil War, to devise mechanical apparatus to be used in special cases of gun-shot wounds. From 1850 till his death he lived in New York, devoting himself to the construction of artificial limbs, etc. He was the author of *Medical and Surgical History of the War of the Rebellion* (1870-72). He died in Greenwich, Connecticut, Dec. 31, 1880.

**HUDSON**, ERASMUS DARWIN, JR., an American physician; born in Northampton, Massachusetts, Nov. 10, 1843. He graduated at the College of the City of New York in 1864, and at the College of Physicians and Surgeons in 1867; house-surgeon in Bellevue Hospital in 1867 and 1868; health-inspector of New York City in 1869 and 1870; from 1870 till his

death, attending physician for Trinity Chapel parish and Trinity Chapel Home; occupied a chair in the Women's Medical College of New York from 1872 to 1882; in the New York Polyclinic from 1882 to 1887. He was the author of *Diagnostic Relations of the Indigestions* (1876); *Doctors, Hygiene and Therapeutics* (1877); *Home-Treatment of Consumptives* (1886); and *Physical Diagnosis of Thoracic Diseases* (1887). He died May 9, 1887.

**HUDSON**, HENRY NORMAN, an American Shakespearean scholar; born in Cornwall, Vermont, Jan. 28, 1814. He graduated at Middlebury College in 1840, and afterward taught in Kentucky and Alabama. He published his first *Lectures on Shakespeare* in 1848; in 1849 he was ordained deacon in the Episcopal Church; in 1859-60 was rector in Litchfield, Connecticut; during the Civil War was army chaplain; for a time editor of the *Churchman*, the *American Church Monthly* and the *Saturday Evening Gazette*, afterward professor of Shakespeare at Harvard, and edited an edition of *Shakespeare* in 1850-57. He was the author of *A Chaplain's Campaign with General Butler* (1865); *Shakespeare: His Life, Art and Characters* (1872); and *Studies in Wordsworth* (1874). He died in Cambridge, Massachusetts, Jan. 16, 1886.

**HUDSON**, MARY CLEMMER, an American authoress and poetess; born in Utica, New York, in 1839. Her maiden name, and the one she wrote for many years under, was Mary Clemmer, and by it she was best known. Her first literary work was for the press. She was the friend of Alice and Phœbe Cary, and wrote their biographies. Monographs on Margaret Fuller, George Eliot, Charles Sumner, Longfellow and Emerson were from her pen. She wrote *Victoria* (1864); *Eirene* (1870); *Ten Years in Washington* (1871); *His Two Wives* (1874); and a volume of poems (1882). She was married, while very young, to the Rev. Daniel Ames, but was divorced in 1879, and married Edmund Hudson in 1883. Died in Washington, D. C., Aug. 18, 1884.

**HUDSON**, WILLIAM HENRY, an English author; born in London, May 2, 1863; was secretary to Herbert Spencer for five years; assistant librarian in Cornell University from 1890 to 1892; assistant professor of English literature at Leland Stanford University in 1892; published *The Church and the Stage* (1886); *An Introduction to the Study of Herbert Spencer* (1893); and *Introduction to the Philosophy of Herbert Spencer* (1894).

**HUDSON'S BAY**, a gulf or inland sea, in the northeast of North America, completely landlocked, except on the north, where Southampton Island and Fox Channel lie between it and the Arctic Ocean, and where Hudson's Strait, running five hundred miles southeast, connects it with the Atlantic. Including its southeastern extension, James's Bay, it measures about eight hundred miles in length and six hundred in greatest width, and has an area of three hundred thousand square miles. The eastern shore, called the East Main, is for the most part rocky, and is fenced with several small islands; the western shore, the West Main, is generally flat. This sea is the great drainage-reservoir of the Canadian northwest territories. In the summer months it is



a great whaling-field. Of late years a movement has been on foot for opening a direct communication from England with Manitoba and the northwest of Canada by way of Hudson's Bay and Strait. The scheme provides for a railway from Winnipeg to Fort Nelson, on the bay, a distance of 650 miles, of which 40 miles were constructed by the end of 1890. The chief objection to the project is that the strait is only navigable for about three months annually. This route would effect a saving of 775 miles, as compared with the route by way of Montreal, and of 1,130 as compared with that by New York.

HUEFFER, FRANCIS, a German musical critic and Provençal scholar; born at Münster, Westphalia, in 1845; studied at Berlin, Leipsic and Paris, and settled in London in 1869. He soon became an authority on music, was musical critic of the *Times*, and was recognized as the champion in Britain of Wagner and Wagnerian music at the time when the Wagnerian controversy was at its height. In 1869 he edited the works of the Provençal poet Guillem de Cabestan, and in 1878 published *The Troubadours: A History of Provençal Life and Literature in the Middle Ages*. Two works on Wagner were from his pen—one in 1874, the other in the Great Musician Series, in 1881. He died Jan. 19, 1889.

HUEHUETENANGO, a state of western Guatemala, bounded on the west and north by Mexico, on the east and south by Quiche and other smaller states of Guatemala. The surface is mountainous, but fertile, and it is drained by the rivers Dolores, Ixcan and Negro, and their tributaries. The chief occupation of the inhabitants is agriculture, the raising of sugar-cane, coffee, cotton, wheat, oats and fruit. There are gold, silver, iron, lead and salt mines, but the last two only are worked. The manufactures are of woolen and cotton goods.—HUEHUETENANGO, the capital of the state, is situated in the southeastern part, 106 miles N.W. of Guatemala City. Population 1890, 11,200; of the state, 136,114.

HUERTA, VICENTE GARCIA DE LA, a Spanish poet and critic; born at Zafra, in Estremadura, in 1730, and spent most of his life in Madrid, where he was head of the Royal Library. His poems were published in two volumes in 1778-79. He was the editor of the *Teatro Español*, a collection of the best of the older Spanish dramas. His own play, *Raquel*, founded on the story of the love of King Alfonso VIII for the Jewess Rachel, won him a great reputation, and is still considered one of the best dramas of modern Spanish literature. He died March 12, 1787.

HUET, CONRAD BUSKEN, a Dutch littérateur; born at The Hague, Dec. 28, 1826; studied for the ministry in Leyden and in Switzerland; preached for a time in Utrecht, and then in Haarlem; in 1862 left the ministry and devoted himself entirely to literary pursuits; became literary critic on *De Gids*; in 1867 he went to Batavia, on the Island of Java, and became editor of the *Java-Bode*, and afterward proprietor and editor of the *Algemeen Dagblad van Nederlandsch Indië*; returned to Europe in 1876, and settled in Paris. Among his works are *Litterarische Phantasien* (1868); *George Sand* (1877);

*Oude Romans* (1877); and *Potgieter* (1878). He died in Paris, May 1, 1886.

HUET, FRANÇOIS, a French religious reformer; born at Villeau, Dec. 26, 1814; for a time was professor in the University of Ghent; became in 1865 tutor of Prince Milan Obrenovitch of Servia. Huet instituted the religious movement called by himself Neo-Catholicism. He was the author of *Historical and Critical Researches on the Life of Henri de Gand* (1838); *History of the Life of Bordas Demoulin* (1861); and *The Religious Revolution in the Nineteenth Century* (1868). He died in Paris, July 1, 1869.

HÜGEL, KARL ALEXANDER ANSELM, an Austrian diplomatist and author; born at Ratisbon, April 25, 1796; studied law at Heidelberg in 1811, and entered the Austrian army in 1813; was employed on different foreign missions, and in 1824 retired and gave himself up to the study of the natural sciences. He published *Kashmir and the Empire of the Sikhs* (1840-42) and *The Basin of Cabul* (1851-52). He died in Brussels, June 2, 1870.

HUGER, BENJAMIN, an American soldier, born at Santee, South Carolina, in 1805; after graduating at West Pont, he became a captain of ordnance in 1832, and was made chief of ordnance to General Scott's army in the Mexican war. In 1855 he became major; but in 1861 entered the Confederate service as brigadier-general and rose soon to be major-general. As such he commanded at Norfolk when the national forces captured the place, May 10, 1862. Huger quickly withdrew, after having fired the navy-yard, the *Virginia*, *Merrimac* and some other vessels. Subsequently he led a division in the seven days' fight in front of Richmond. After the war he became a farmer in Virginia. He died in Charleston, South Carolina, Dec. 7, 1877.

HUGGINS, WILLIAM, an English astronomer and spectroscopist; born in London, Feb. 7, 1824, and educated at the City School and by private instructors, giving much attention to the experimental study of the physical sciences and of astronomy. In 1852 he was elected a member of the Microscopical Society, and was for several years engaged in the study of physiology, animal and vegetable, with the microscope. In 1855 he built a private observatory at Upper Tulse Hill, near London, and began what proved to be the principal work of his lifetime—his well-known spectroscopic observations and photographing of stellar spectra, the solar corona, etc. (See Vol. XVII, p. 711). He was president of the Royal Astronomical Society from 1876 to 1878, and President of the British Association for 1891.

HUGH CONWAY, the pseudonym of FARGUS, FREDERICK JOHN; q.v., in these Supplements.

HUGHES, BALDWIN, an English sculptor; born in London, England, Jan. 19, 1806. He studied for seven years with a modeler and sculptor, and exhibited specimens of his work at the London Society of Arts, for which he received several silver medals. Among these achievements was an original composition, *Pandora Brought to Earth by Mercury*, which gained him a gold medal. He afterward made a number of ideal statuettes and many busts. In 1829

he removed to New York City, and began work by making a statute of Alexander Hamilton, which was placed in the rotunda of the Merchants' Exchange. He also made a monumental relief of Bishop Hobart, now in the vestry of Trinity Church. Later Mr. Hughes went to Dorchester, Massachusetts, where he modeled *Little Nell* and *Uncle Toby and Widow Wadman*, which are preserved in plaster at the Boston Athenæum. He died in Boston, Massachusetts, March 5, 1868.

HUGHES, DAVID EDWARD, an English-American inventor; born in London in 1831. He subsequently emigrated with his parents to the United States. In 1850 he was appointed professor of music at the college of Bardstown, Kentucky, and later professor of natural philosophy in the same institution. His first great invention was that of the printing-telegraph which bears his name, which in 1855 became a practical success. He failed to introduce the invention into England, but it was adopted in the United States, and by the French, Italian, Russian and other foreign governments. In 1878 Professor Hughes invented the microphone, and in 1879 the induction-balance. In 1880 he was elected a fellow of the Royal Society. In 1881 he represented Great Britain as one of the commissioners at the Paris Electrical Exposition.

HUGHES, HUGH PRICE, a Welsh Wesleyan preacher; born Feb. 7, 1847, at Carmarthen, South Wales. He was educated at University College, London, and the Richmond Theological College. His first appointment was at Dover, and he preached afterward at Brighton, Oxford and London. He was then appointed to the position of superintendent of the West London Mission. He was exceedingly zealous in all kinds of social reforms, and was the editor of the *Methodist Times*, an active worker in the cause of total abstinence, a permanent member of the Methodist Conference, and a leader in the so-called "forward movement" in the Methodist Church which aims at social as well as individual salvation. He published *Social Christianity* (1889); *The Philanthropy of God* (1890); *Ethical Christianity* (1892); and *Essential Christianity* (1893).

HUGHES, JOHN, an Irish-American Catholic archbishop; born at Annaboghan, County Tyrone, Ireland, June 24, 1797. He emigrated to the United States, worked first as a gardener, then studied theology at Mount St. Mary's College, Emmitsburg, Maryland, where he supported himself by taking care of the college garden, and afterward by teaching in the college. He was ordained priest in 1826, and had charge of churches in Philadelphia till 1838; founded St. John's Orphan Asylum, and established the *Catholic Herald*. In 1842 he became bishop of New York. He then organized the Roman Catholics against New York's public-school system, and instituted a system of parochial schools. In 1850 the diocese of New York had so increased by immigration that Hughes was made archbishop. Secretary Seward sent him and Thurlow Weed to Europe in 1861 to set before the foreign governments the true object in conducting the war, and during the draft riots in 1863 he urged upon the excited population of New York the duty

of submission to the United States government. Archbishop Hughes first attracted attention as a disputant in his controversy with the Rev. John Breckinridge upon the question, *Is the Protestant Religion the Religion of Christ?* carried on by an interchange of public letters afterward published in book-form (1833), and later by his dispute with Erastus Brooks respecting the tenure of church property in New York. He was active as an organizer. When he took charge of his bishopric of New York there were few churches and these heavily in debt, and fewer schools and colleges. He obtained priests from Europe, founded St. John's College at Fordham and a theological institute at Troy, started the erection of St. Patrick's in New York, and improved and systematized the parochial school system. He died Jan. 3, 1864.

HUGHES, THOMAS, an English author; born at Uffington, Berkshire, England, Oct. 20, 1823. He was educated at Rugby under Dr. Arnold, and at Oriol College, Oxford, graduating in 1845. Called to the bar in 1848, he became queen's counsel in 1869; member of Parliament from Lambeth from 1865 to 1868, and from Frome in 1869 to 1874. He early became associated with the work of social and sanitary reform



THOMAS HUGHES.

among the London poor, and with Charles Kingsley became a supporter of the Christian Socialists; took a prominent part in the debates relating to trades unions and the law of master and servant. His best-known work, *Tom Brown's School Days* (1856), is a truthful picture of life at Rugby, written from the author's own boyish impressions. It was followed by *The Scouring of the White Horse* (1858); *Tom Brown at Oxford* (1861); *Alfred the Great* (1869). In 1880 he assisted in founding a settlement in the United States, an account of which he published under the title of *Rugby, Tennessee*, (1881). He also wrote lives of *Daniel Macmillan* (1882) and *Bishop Fraser* (1887), edited Lowell's *Biglow Papers*, and wrote introductions to Whitman's and to Lowell's poems. He died at Brighton, March 22, 1896.

HUGO, VICTOR MARIE, a French poet; the foremost man of letters of his time, and the leader of the modern romantic school in France; was born at Besançon, Feb. 26, 1802, and died in Paris, May 22, 1885. His father was a distinguished general under Napoleon, and young Hugo in early life came almost wholly under the influence of his mother, who was a devout churchwoman and ardent



VICTOR HUGO.

Bourbonist. He was educated partly in Paris at the Feuillantines and at L'École Polytechnique and partly at Madrid, where his father held an appointment at the court of Joseph Bonaparte, then King of Spain. At an early age he began to pay his addresses to the muses, writing youthful tragedies and melodramas, and striving for poetic honors in academic competitions. In his twentieth year he published a collection of *Odes et Ballades*, and had already gained a prize for verse from the French Academy, and had thrice been victor at the floral games at Toulouse. At this time, such was his precocity that Chateaubriand hailed him as "a sublime child." His mother died at this epoch in his life, when fame was coming to him, and before he broke with his conservative past in politics and religion. At this period, also, he married, the King (Louis XVIII) brightening the future of the young couple with a pension of 1,500 francs, which he afterward doubled. The chaste, sobering influence of his mother being withdrawn, the youthful poet plumed his wing for fantastic flights in verse and for extravagant ventures in fiction. The fruits of this era of bombastic and turgid work are two romances, *Han d'Islande* (1823) and *Bug-Jargal* (1824), and, in politics of a quasi-revolutionary character, his drama of *Cromwell* (1827). In 1828 he published *Les Orientales*, a collection of poems in which he manifests his mastery of rhythm, and two years later came his great and successful drama, *Hernani*, the appearance of which brought on the long and vexed controversy between the classic and the romantic school of writers. Romanticism won, and became an accepted influence in French literature.

In 1830-31, Hugo, actuated by the success of Sir Walter Scott in British fiction, entered the field of the historical novel, and published his picturesque mediæval romance *Notre Dame de Paris*. This was followed by a sheaf of lyrical verse, which contains much of his best poetry, *Les Feuilles d'Automne* (1831), and one of his finest plays, *Marion Delorme* (1831), which was produced with great éclat at the Théâtre Français. In 1832 the play *Le Roi s'Amuse* (better known as *Rigoletto*), after falling under the ban of the public censor, was permitted to appear, though, as it contained passages of an antimonarchical character, its repetition on the stage was forbidden by the authorities. His next dramas were in prose—*Lucrèce Borgia* and *Marie Tudor* (1833), neither of which was creditable to the author's morals or to his regard for the truth of history. A third melodrama in prose, *Angelo*, appeared in 1835, together with a collection of admirable verse, *Les Chants du Crépuscule*. Two years afterward the latter was followed by perhaps his noblest effort in song, *Les Voix Intérieures*, made notable by fine poetic workmanship. In 1838 *Ruy Blas* appeared, and, next to *Hernani*, is the most successful of his writings for the stage. *Les Burgraves* and *Les Rayons et les Ombres*, a drama, and a collected volume of verse belong to this period, with two novels, *Le Dernier Jour d'un Condamné* (1828) and *Claude Gueux* (1834), written from the humanitarian standpoint as protests against the infliction of the death penalty.

For a number of years Hugo's muse was silent; for he had entered the field of politics, become a member of the French Academy, and was made a peer of France. In the upheaval of the times, a change now came over his political opinions, and though he ever remained loyal to Napoleon I, he ceased to be a Legitimist, and embraced the republic which followed the revolution of 1848. His increasing democracy showed itself in an ardent sympathy with social reform, though he frowned upon the excesses of the revolution, and at first he hailed the advent of Louis Napoleon. Afterward he became his satirist and bitter enemy. His apostasy at this time was due largely to his own personal vanity, and when the *coup d'état* of 1851 came, as it threatened his political eminence as the orator and oracle of democracy, he unsparingly denounced the Prince-President and lampooned him in his philippic, *Napoléon le Petit* (1852). Banishment followed, and from his refuge, first in Jersey and afterward on the neighboring island of Guernsey, he launched at the usurper's head his political satire, *Les Châtiments* (1853), and in his exile wrote the indignant narrative *L'Histoire d'un Crime*, which, however, was not published till 1877. Though prohibited by the government of the third empire, *Napoléon le Petit* and *Les Châtiments* found their way from Belgium into France, and there kept alive revolutionary sentiments, and a more or less passionate admiration among the people for the genius and patriotism of Victor Hugo.

From his seclusion Hugo watched closely the trend of political events in France, for he had no faith in the stability of the empire, and worked industriously, and with more leisure for meditative thought, upon the new products of his pen. In 1856 he published *Les Contemplations*, a group of elegiac and lyrical verse of much poetic beauty; and three years afterward came the bewitching volumes *La Légende des Siècles*. This was followed, after another lapse of three years, by his masterpiece, *Les Misérables*, a romance of modern life, which was instantly translated into ten different languages; *Les Travailleurs de la Mer* (1866), a prose idyll of fisher-folk life in Guernsey; and by *L'Homme qui Rit* (1869), a labored bit of historical fiction, designed to amuse but which often succeeds in wearying the reader. In addition to these works, he issued *Les Chansons des Rues et des Bois* (1865), a gathering of artistic poems in a light vein, and *William Shakespeare*, (1864), a rhapsodical introduction to an edition of the English poet's writings, translated by Hugo's son.

The fall of the empire at Sedan, in September, 1870, enabled Hugo to re-enter France, and, proceeding to Paris, he summoned the invading Germans to withdraw from the country. He remained within the city during the siege, a record of which is preserved in *L'Année Terrible* (1872), and for a time he was a member of the National Assembly. In the latter capacity he opposed the ratification of peace with Germany and the cession of Alsace and Lorraine. Being interrupted in the Assembly while defending Garibaldi, he resigned his seat, and after a futile effort to save the Column Vendôme from destruction during the Commune, he withdrew to Brussels, where he came into collision with the Bel-

gian authorities for harboring Communists, and was expelled the kingdom. On his return to Paris he contested a seat in the Assembly, but was beaten, though he was afterward made a Senator. In 1874 he published *Quatre-vingt-treize*, his last romance in prose, and in the following year a collection of his *Speeches and Addresses*. His later works embrace, besides *L'Histoire d'un Crime*, already mentioned, and a second series of *La Légende des Siècles* (1877), *L'Art d'Être Grand-père* a volume of charming domestic lyrics (1877); *Le Pape*, an anticlerical effusion (1878); *La Pitié Suprême* (1879); *L'Âne*, a satire against pedants (1880); *Torquemada*, a drama (1882); and *Les Quatre Vents de l'Esprit* (1881-83).

Most of these recent writings show that the literary cunning had passed from the hand of the great poet-novelist, but he has left much in proof of his genius, though not a little of that is sadly marred by his self-sufficiency and egotism. His death restored the luster of his fame among his countrymen, and with them, as with all admirers of genius, the best of his writings are sure of immortality. On his deathbed he refused the offices of an attending priest, a proof that in religious matters he had entirely broken with his early faith. On the 1st of June, 1885, he was buried with public honors in the Panthéon. By his will he left his manuscripts, including those of several unpublished works, to the *Bibliothèque Nationale*.

The *Letters of Victor Hugo*, edited by Paul Meurice, his literary executor, and embracing his correspondence with his father, his wife, his friends including letters to M. Sainte-Beuve, and others with his children, appeared in an English dress in 1896.

#### G. MERCER ADAM.

**HULIN OR HULLIN, PIERRE AUGUSTIN**, a French soldier; born in Paris, Sept. 6, 1758. He joined the army in 1771, siding with the revolutionists in 1789; became adjutant-general to Napoleon in 1796; general of a division in 1802; presided over the court-martial which condemned the Duke of Enghien to death in 1804; was military governor of Paris in 1812, and put down the conspiracy of Malet against Napoleon. When the Bourbons were restored he was banished, but allowed to return to Paris in 1819, where, in 1823, he published a defense of the action of the military commission in the affairs of the Duke of Enghien. He died in Paris, Jan. 9, 1841.

**HULL**, a town of Ottawa County, southwestern Quebec, Canada, on an island in the Ottawa River, opposite Ottawa City, with which it is connected by a suspension-bridge, and on the Canadian Pacific railroad. It has abundant water-power, and manufactures axes, lumber, matches, pails, paper and wooden-ware, and has carding and woolen mills. On April 26, 1900, it was visited by a most destructive fire. (See OTTAWA.) Population 1881, 6,890; 1891, 11,265.

**HULL, EDWARD**, an Irish geologist; born in Antrim, Ireland, May 21, 1829. He very early developed a taste for geological studies, to which he determined to devote his life. He was appointed on the Irish survey in 1869, and ulti-

mately became director of the survey. Later he was appointed professor of geology in the Royal College of Science, Dublin. In 1883 he visited Arabia, Petraea and Palestine, and made a geological and topographical survey of the Arabah Valley and adjoining territories between the Sinaitic peninsula on the south and southern Palestine on the north. His works include *The Coal-fields of Great Britain* (1865); *Sketch of Geological History* (1887); *Text-Book of Physical Geography* (1888); *Geology and Geography of Arabia Petraea, Palestine and Adjoining Districts* (1886); and *A Sketch of Geological History* (1887).

**HULL, ISAAC**, an American naval officer; born at Derby, Connecticut, March 9, 1773. In 1798 he became lieutenant, and served with credit in the West Indies and the Mediterranean; in 1806 was made captain, and just before hostilities broke out between the United States and England, took command of the *Constitution*. On Aug. 19, 1812, occurred his famous encounter with the *Guerrrière*, which resulted in the defeat of the enemy and the almost total destruction of the British ship. Hull was given a gold medal by Congress for his victory. Afterward he commanded a squadron in the Pacific, later in the Mediterranean, and for a time was head of the Boston and Washington navy-yards. He died in Philadelphia, Feb. 13, 1843.

**HULL, WILLIAM**, an American general; born at Derby, Connecticut, June 24, 1753. He studied law, and was admitted to the bar in 1775. He joined the American army at Cambridge as captain, fought at White Plains, Trenton and Princeton, and was then promoted to major. Afterward he was engaged at Ticonderoga, Stillwater, Saratoga, Monmouth and Stony Point. After the war he practiced law at Newton, Massachusetts, and was prominent in the Massachusetts legislature. In 1798 he was appointed judge of the court of common pleas, and in 1805 he became governor of Michigan territory. At the outbreak of the War of 1812 Hull commanded the Northwestern army, consisting of raw militia. He surrendered Detroit and the entire Northwest to the English, and for this he was court-martialed and sentenced to be shot, but President Madison pardoned him on account of past services. In 1824 he published the *Campaign of the Northwest Army*. His *Life* was published by his daughter, Mrs. M. Campbell. He died at Newton, Massachusetts, Nov. 29, 1825.

**HULLAH, JOHN PYKE**, an English musical composer; born at Worcester, June 27, 1813. He studied at the Royal Academy of Music, and in 1840 began popular singing-classes in London, continuing the work for over twenty years. He was for some time professor of vocal music in King's College, and from 1874 to 1882 was inspector of training-schools for the United Kingdom. His comic opera, *The Village Coquette*, was published in 1836. Of his songs, *The Three Fishers* and *The Storm* attained wide popularity. For a time he was musical critic on the *Globe*. He died in London, Feb. 21, 1884.

**HULSEAN LECTURES.** See HULSE, JOHN, Vol. XII, p. 342.

**HUMANISM.** See RENAISSANCE, Vol. XX, pp. 384-389 et seq; and PETRARCH, Vol. XVIII, pp. 707, 709, 710.

**HUMBER,** a river of northeastern England, separating York from Lincolnshire, formed by the union of the Trent and Ouse, in lat.  $53^{\circ} 38'$  N., long.  $1^{\circ} 42'$  W. It ranges from 2 to 4 miles in breadth and is navigable for vessels of the first class for 22 miles, as far as Hingston-upon-Hull. Its whole length is but 40 miles, yet, with its tributaries, it drains 9,550 square miles, nearly a sixth of England.

**HUMBER,** a river of Newfoundland, which rises in Adie's Pond, takes an easterly direction, but turns almost immediately southwest and flows through Deer Pond into the Bay of Islands, by Humber Arm. It receives the waters of Grand Lake. Its course, for most of the distance, is lined with forests, and molybdenum ores have been discovered near the mouth. It has not been possible to work them, however, as permanent settlements of Newfoundlanders on this coast are expressly forbidden by treaty.

**HUMBERT I, RÉNIER CHARLES EMMANUEL JEAN MARIE FERDINAND EUGÈNE,** King of Italy;



KING HUMBERT I.

born March 14, 1844. He attended his father, Victor Emmanuel, during the war of Italian independence in 1859. In 1866, when Italy fought with Austria, the prince took the field as commander of a division in General Cialdini's army, and was present at the disastrous battle of Custoza, June 23, 1866. After Rome was occupied in 1870 by the Ital-

ian troops, he took up his residence there, and on the death of his father, Jan. 9, 1878, succeeded to the throne of Italy. Later in the year an attempt was made to assassinate him, but failed. At Monza, July 29, 1900, another attempt, which unhappily succeeded, was made on the King's life, the assassin being an Italian anarchist known in Paterson, N. J., as Gaetano Bresci. During the cholera epidemic at Naples King Humbert exposed himself frequently in his endeavors to alleviate the sufferings of the sick and dying. By these and other acts of kindness the King won the affections of the Italian people. In 1868 he married Princess Marguerite of Savoy, and a son was born of this marriage in 1869, who succeeded to the throne as Victor Emmanuel III.

**HUMBOLDT,** a post village of Humboldt County, northwestern central Iowa, on the Des Moines River, and on the Minneapolis and St. Louis railroad, 15 miles N. of Fort Dodge. It is the seat of Humboldt College. Population (1900), 1,474.

**HUMBOLDT,** a city of Allen County, south-

eastern Kansas, on the Neosho River, and on the Atchison, Topeka and Santa Fé railroad, 38 miles W. of Fort Scott. It has various manufactories, including those of flour, cheese, woolen goods and wagons and carriages. It is in a productive agricultural and stock-raising section. Population 1890, 1,301; 1900, 1,402.

**HUMBOLDT,** a city of Richardson County, southeastern Nebraska, on the North fork of the Nemaha River, and on the Burlington and Missouri River railroad, 21 miles N.W. of Falls City. It has several flour-mills, and is in a farming and grazing section. Population 1900, 1,218.

**HUMBOLDT,** a town and railroad junction of Gibson County, northwestern Tennessee, 18 miles N.W. of Jackson, on the Louisville and Nashville and the Mobile and Ohio railroads. It has mills and a foundry, and educational institutions supervised by Odd Fellows. It is the center of a fruit, cotton and vegetable producing country, and has large nurseries. It has foundries, saw and planing mills, spoke, stave and box factories, cotton-gins and marble-works. Population 1900, 2,866.

**HUMBOLDT RIVER,** a stream of northwestern Nevada, rising in two forks in Elko County, and flowing generally west into Humboldt County, where it turns southwestward and empties into Humboldt Lake, after a course of 390 miles. This lake is nearly 4,000 feet above sea-level. The river follows the only valley in Nevada which runs east and west, although many run from north to south. It is followed throughout its entire course by the Central Pacific railroad. Its waters are remarkable for carrying a considerable amount of soda.

**HUMERUS.** See ANATOMY, Vol. I, p. 827.

**HUMIDITY.** See METEOROLOGY, Vol. XVI, pp. 119-123; ATMOSPHERE, Vol. III, pp. 32, 33; and HYGROMETRY, Vol. XII, pp. 569-571.

**HUMILIATE NUNS.** See HUMILIATI, Vol. XII, p. 356.

**HUMILIATES.** See HUMILIATI, Vol. XII, p. 356.

**HUMMELSTOWN,** a village of Dauphin County, southeastern central Pennsylvania, on the Philadelphia and Reading railroad and on the Union canal, 8 miles E. of Harrisburg. It has extensive limestone and brownstone quarries, several mills, a machine-shop, carriage factory and electric and water plants. Population 1890, 1,486; 1900, 1,729.

**HUMPBACK WHALE.** See WHALE, Vol. XXIV, p. 524.

**HUMPHREY, HEMAN,** an American clergyman and educator; born at West Simsbury, Connecticut, March 26, 1779. He studied theology at Yale College, and was a Congregational pastor at Fairfield, Connecticut, from 1807 to 1817, and then in Pittsfield. From 1823 to 1845 he was president of Amherst College, to the character, growth and prosperity of which he largely contributed. He was the author of *Tour in France, Great Britain and Belgium* (1838). He died in Pittsfield, Massachusetts, April 3, 1861.

**HUMPHREYS, ANDREW ATKINSON,** an Ameri-

can soldier and engineer; born in Philadelphia, Nov. 2, 1810; graduated at West Point in 1831.



GEN. A. A. HUMPHREYS.

In 1838 he became first lieutenant of topographical engineers. From 1845 to 1849 he had charge of the Coast Survey Office, and afterward began the topographic and hydrographic survey of the delta of the Mississippi. This work he resumed in 1857, after he had examined the river deltas in Europe and the means employed for protection against inundations. During the Civil War he became a major-general of volunteers, was

engaged at the battles of Fredericksburg, Chancellorsville and Gettysburg, and commanded a corps in the siege and capture of Petersburg, and in the pursuit and capture of Lee's army. In 1866 he was appointed chief of engineers of the United States army, with rank of brigadier-general, and engaged in engineering-work on the Mississippi. He retired in 1879, and died in Washington, District of Columbia, Dec. 27, 1883.

HUMPHREYS, DAVID, an American soldier; born at Derby, Connecticut, in 1752. In the Revolutionary War he was aide-de-camp to General Putnam, and then to General Washington. He distinguished himself at the siege of Yorktown in 1781. In 1784 he went to Paris and London as secretary of legation to Benjamin Franklin, John Adams and Thomas Jefferson, who negotiated treaties of commerce and amity with European powers. In 1790 President Washington appointed him minister to Portugal, where he remained till 1794. In 1797 he was sent to the court at Madrid as minister plenipotentiary, where he stayed till 1802. On his return from Spain he imported one hundred merino sheep, and for some time thereafter he engaged in the manufacture of woollens at Derby. In the War of 1812 he commanded the Connecticut troops as brigadier-general. He was noted as a poet and wit. He helped in producing the *Anarchoid* and other satiric verse; he also published *An Address to the Armies of the United States* (1772) and other poems. He died in New Haven, Feb. 21, 1818.

HUMPHREYS, MILTON WYLIE, an American educator; born at Greenbrier, West Virginia, Sept. 15, 1844; was educated at Washington University (now Washington and Lee University), leaving during the Civil War to serve as gunner in the Confederate army; became tutor and later professor in his alma mater; studied in Leipsic; made professor of Greek in Vanderbilt University (1875); professor of ancient languages in Texas University (1883); professor of Greek at the University of Virginia (1887); for a time was American editor of the *Revue des Revues*; published editions of *The Clouds of Aristophanes*; *The*

*Antigone of Sophocles*; *Ædipus Tyrannus* and the second book of *Thucydides*.

HUMPHRY, SIR GEORGE MURRAY, an English anatomist; born in Sudbury, England, July 18, 1820. Studied at the hospital in Norwich, at St. Bartholomew's, and received his M.D. from Cambridge (1856); was made professor of surgery at Cambridge (1883). He was the author of *A Treatise on the Human Skeleton* (1858); *On Myology* (1872); *Old Age and the Changes Incidental to It* (1889); *Hunterian Oration* (1879). After 1867 he was on the staff of the *Journal of Anatomy and Physiology*. Was knighted in 1891. He was recognized as the leading British authority in surgery. He died in London, Sept. 25, 1896.

HUNAN OR HOO-NAN, an inland province of China. See CHINA, Vol. V, p. 637.

HUNDRED DAYS, THE. See NAPOLEON, Vol. XVII, pp. 223-225; and FRANCE, Vol. IX, p. 618.

HUNDRED YEARS' WAR, THE. See FRANCE, Vol. IX, pp. 545 et seq.

HUNERIC. See VANDALS, Vol. XXIV, p. 58.

HUNFALVY, PÁL, a Hungarian philologist, and the founder of philological studies in Hungary; born at Nagy-Szalok, March 12, 1810. He was educated at the University of Pesth and admitted to the bar in 1838; became professor of law at Kasmark University; deputy to the National Assembly in 1848; in 1856 founded a philological magazine, *Magyar Nyelorszet*. He published *Chrestomathia Fennica* (1861); *A Journey Across the Country of the Baltic* (1871); *The Language of the Kondawoguls* (1872); *Hungarian Ethnography* (1876); *Hungarians or Magyars* (1881). He died at Pesth, Nov. 30, 1891.

HUNGARIAN GRASS, the name given to a species of *Scaria*, much prized as a forage-grass on account of its luxuriant growth even upon sterile soils.

HUNGARIAN LANGUAGE AND LITERATURE. See HUNGARY, Vol. XII, pp. 374-380.

HUNGER. See NUTRITION, Vol. XVII, pp. 667, 668; and DIETETICS, Vol. VII, pp. 200 et seq.

HUNGERFORD, MRS MARGARET WOLFE (HAMILTON), an Irish authoress, born and educated in Ireland. Either anonymously or under the pen-name of "The Duchess" she wrote *Phyllis* (1877); *Molly Bawn* (1878); *Beauty's Daughters* (1880); *Portia* (1882); *Rossmoyne* (1883); *A Maiden All Forlorn* (1885); *A Mental Struggle* (1886), etc. Died at Bandon, Ireland, Jan. 24, 1897.

HUNKERS, a faction of the Democratic party of New York. See BARNBURNERS, in these Supplements.

HUNT, HELEN. See JACKSON, HELEN MARIA, in these Supplements.

HUNT, HENRY JACKSON, an American soldier; born in Detroit, Michigan, Sept. 14, 1819; graduated at West Point in 1839; served on the Canadian frontier, and distinguished himself in Mexico, where he was wounded twice. He became captain in 1852 and major in 1861, held an artillery command at Bull Run, and became aid to McClellan. In September, 1862, he was made

brigadier-general of volunteers. As chief of artillery of the army of the Potomac, he fought at Gettysburg, in the campaign from the Rapidan to Petersburg, and became brigadier and major general, United States army. He was president of the artillery board; was retired from active service in September, 1883, and became governor of the Soldiers' Home at Washington, District of Columbia. He died Feb. 11, 1889, in Washington.

HUNT, RICHARD MORRIS, an American architect; born in Brattleboro, Vermont, Oct. 31, 1828. He studied at the École des Beaux-Arts and in the office of Lefuel in Paris, through whom he was appointed an inspector of the construction of the building between the Louvre and the Tuileries, and placed in charge of the Pavillon de la Bibliothèque. In 1855 he returned to the United States, after which time he did much to elevate architecture, being largely influential in founding the American Institute of Architects. He received honors from several societies abroad; among them, the Queen's gold medal of the Royal Institute of British Architects in 1893, and the cross of the Legion of Honor. He built residences and buildings in all the large Eastern cities; among them, the pedestal of the Statue of Liberty, New York Tribune Building, the United States Naval Observatory, and the Administration Building at the World's Columbian Exposition, Chicago, 1893. Mr. Hunt had his headquarters in New York. He died in Newport, Rhode Island, July 31, 1895.

HUNT, ROBERT, an English engineer; born at Devonport, England, 1807; was the keeper of mining records at the Museum of Practical Geology, and was the first appointed professor of mechanical science to the government school of mines; organized the Miners' Association of Cornwall and Devonshire, for the purpose of giving scientific education to practical miners. He is best known by his work on *Photography*, published in 1842; *Researches on Light*; *The Poetry of Science*; and *Panthea; or, The Spirit of Nature* (1849); *Elementary Physics* (1851); and *Manual of Photography* (7th ed. 1857); and was the editor of three editions of *Ure's Dictionary of Arts, Manufactures and Mines*. He died Oct. 17, 1887.

HUNT, THOMAS STERRY, an American chemist and geologist; born at Norwich, Connecticut, Sept. 5, 1826. He studied chemistry under Professor Benjamin Silliman at Yale College. In 1847 he entered upon the duties of geologist and mineralogist in the geological survey of Canada, under Sir William Logan. While holding this position he was for some years professor of chemistry in McGill College, Montreal. In 1872 he became professor of geology in the Massachusetts Institute of Technology. He served on the international jury of the world's fairs of 1855 and 1867 in Paris; was made fellow of the Royal Society (1859), and received the cross of the Legion of Honor (1867). Professor Hunt published many important papers on chemistry, mineralogy and geology, which appeared in

the *American Journal of Sciences* and in other scientific periodicals of both Europe and America. Among his publications are *Chemistry of the Earth* (1869); *Mineral Geology and Physiography* (1886); and *Coal and Iron in Southern Ohio* (1881). He died in New York, Feb. 12, 1892.

HUNT, WARD, an American jurist; born at Utica, New York, June 14, 1810; graduated at Union College in 1828; studied law in Litchfield, Connecticut, and practiced at Utica. He was a member of the New York legislature (1839) and mayor of his native city (1844); was elected to the bench of the New York court of appeals (1865); and was appointed associate justice of the United States supreme court (1872); but retired on a pension (1882). He died in Washington, District of Columbia, March 24, 1886.

HUNT, WILLIAM HENRY, an American lawyer; born in Charleston, South Carolina, in 1824; was educated at Yale, and practiced law in New Orleans. In March, 1876, he was appointed attorney-general of Louisiana, and in the fall of the same year was the Republican candidate for the same office. There was a dispute over the election, and the Hayes administration recognized the Democratic contestants. In 1878



WILLIAM HENRY HUNT.

Mr. Hunt was appointed judge of the court of claims, and in March, 1881, he became Secretary of the Navy in the Garfield Cabinet. This position he held until 1882, when he was appointed United States minister to Russia. He died in St. Petersburg, Feb. 27, 1884.

HUNT, WILLIAM HOLMAN, a British figure-painter, and chief of the Pre-Raphaelite School in England, was born in London in April, 1827. He received his art education in the schools of the Royal Academy, and in the year following his admission (1846), he exhibited his first picture, *Hark!*—the figure of a child holding a watch to his ear. A more ambitious picture was produced two years later, *The Flight of Madeline and Porphyro*, from Keats's *Eve of St. Agnes*. At this period, Hunt, in conjunction with Dante Gabriel Rossetti, Sir John E. Millais and other enthusiastic young painters, inaugurated the "Pre-Raphaelite Brotherhood"—a movement in British art, the aim of which was to secure greater truth to nature, and a more vivid and unconventional realization in the treatment of imaginative subjects. The first-fruits of this new departure, so far as Hunt is concerned, was his *Rienzi Vowing to Avenge the Death of His Brother* (1849). Another picture, painted after the same manner, was *The Hireling Shepherd* (1852), and about this time he exhibited two subjects from Shakespeare: *Valentine Rescuing Sylvia from Proteus*, from *The Two Gentlemen of Verona*, and the tragic prison-scene, *Claudio and Isabella*, from *Measure for*

*Measure. Our English Coasts* (known also as *The Strayed Sheep*), a remarkably fine landscape, with skillful sunlight effects and a sense of distance and atmosphere, was also the product of this period. Holman Hunt now turned his attention to religious art, and in 1854 produced a sensation with his impressive symbolical picture, *The Light of the World*. This was followed by *The Awakened Conscience* (1855), and by *The Scapegoat* (1856). In 1854 Mr. Hunt paid a visit to Palestine with the purpose of studying Eastern life, and giving local color to a series of pictures he designed to paint, treating of incidents in Bible history. *The Scapegoat*, just mentioned, is said to have been painted by the Red Sea, close to one of its salt-incrusted shallows, during his sojourn in the East. But the noblest fruits of his visit to the Holy Land were soon to appear in his famous pictures, which attracted hundreds of thousands to see them, and are notable examples of transcendentalism in modern art. These are *The Finding of Christ in the Temple* (1854), of which a smaller replica was produced in 1860; *The Shadow of Death* (1874), a prevision of the crucifixion; *The Triumph of the Innocents* (1875-85); and his more recent work, upon which he spent years of labor and study in the East, *The Flight Into Egypt* (1890); also his *Miracle of the Sacred Fire* (1899). Some of Mr. Hunt's works were exhibited at the Philadelphia Exposition of 1876, and attracted much notice; and a considerable collection, including many of his English subjects, was exhibited in the Fine Arts Society rooms, London, in 1886. One of the finest of his English studies is *The Choristers of Magdalen College, Oxford, Singing the May Day Hymn* (1889). In portrait-work he has also achieved some distinction, as in his study of *Dante Gabriel Rossetti*. As an instance of his marvelous color-work and technique, his *Isabella and the Pot of Basil*, a subject from Keats, may be mentioned.

G. MERCER ADAM.

HUNT, WILLIAM MORRIS, an American painter; born at Brattleboro, Vermont, March 31, 1824. In 1846 he entered the Royal Academy at Düsseldorf, for the purpose of studying sculpture. But after a few months he removed to Paris to become a pupil of Couture, and later of Millet, in painting. Having returned to America in 1855, he opened studios both in Boston and Newport, settling finally in Boston, where he taught painting with great success. His influence in art was considerable, and in a good direction. Among his paintings are *The Drummer-Boy*; *The Bugle-Call*; *The Prodigal Son*; two allegorical mural paintings for the state capitol at Albany, *The Flight of Night* and *The Discoverer*; and his famous *Bathers*. Died at Isles of Shoals, N. H., Sept. 8, 1879.

HUNTER, COLIN, a British artist; born in Glasgow, July 16, 1841. He attended the schools of his own town, but studied art directly from nature. He turned his attention principally to sea and shore pieces and exhibited at the Royal Academy. Among his paintings are *Travelers Waiting for Darkness*; *Give Way*; *Digging Bait*; *The Salmon-Fishers*; *In the Gloaming*; *The*

*Woman's Part*; and *Fishers of the North*; all of which were exhibited at the Royal Academy, of which he was made associate member.

HUNTER, DAVID, an American soldier; born in Washington, District of Columbia, July 21, 1802. After he became a captain of dragoons in 1833, he was assigned to frontier duty, and twice crossed the plains to the Rocky Mountains. In the Mexican War (1846), he was chief paymaster of General Wood's command. When President-elect Lincoln went to Washington in February, 1861, Hunter accompanied him. On May 14, 1861, he became colonel of the Sixth United States Cavalry. During the war he commanded a division at Bull Run, where he was wounded. In August, 1862, he became major-general of volunteers, and successively commanded the Western and Southern military departments. To provide for the fugitive slaves, General Hunter organized the First South Carolina Volunteers, which was the first regiment of black troops in the national service. Upon this, Jefferson Davis issued a proclamation declaring Hunter an outlaw, who, if captured, should not be treated as a prisoner of war, but held in close confinement and executed as a felon. In May, 1864, Hunter was placed in command of the department of West Virginia. He defeated a Confederate force at Piedmont on June 5, 1864; served on various courts-martial and presided over the commission which tried the conspirators who were engaged in the assassination of Lincoln. He was retired from active service in 1866, and died in Washington, District of Columbia, Feb. 2, 1886.

HUNTER, ROBERT MERCER TALIAFERRO, an American statesman; born in Essex County, Virginia, April 21, 1809. After studying law at the Virginia University, he was elected to Congress in 1837 and was chosen Speaker in 1839. In 1845 he was again returned to Congress, and in 1847 he entered the United States Senate, where he was a leading advocate of states' rights till July, 1861, demanding the right of the slaveholder to carry his slaves to any United States territory. He proposed the reduction of the value of subsidiary silver to prevent its exportation. Being an active secessionist he became Secretary of State in the Confederate Cabinet, but was soon superseded by J. P. Benjamin. After this he was elected to the Confederate Senate, and became an opponent of Jefferson Davis's administration. In 1885 he was appointed a collector of customs by the United States government. He died in Essex County, July 18, 1887.

HUNTINGBURG, a village of Dubois County, southwestern Indiana, on the Louisville, New Albany and Corydon railroad, 40 miles E. N. E. of Evansville. It is situated in a region where tobacco, grain and fruit are raised extensively, and where block and cannel coal, plumbago, iron ores, potter's clay, mineral paints, lime and sandstone are obtained. Carriages, wagons, lumber, furniture, saddlery, brick, terra-cotta, flour, woolen goods and tobacco are manufactured. Population 1890, 3,167; 1900, 2,527.



**HUNTINGDON**, a borough and the capital of Huntingdon County, southern central Pennsylvania, located on the Juniata River, on the Pennsylvania railroad and on the Juniata division of the Pennsylvania canal. Lead, coal, iron, fire-clay, limestone and timber abound in the region. Brooms, boots and shoes, furniture, stationery, sewer-pipe and reed and rattan goods are manufactured, and there are planing-mills, flour-mills, a foundry, machine-shop, car-works, a brickyard and several printing-offices in the vicinity. It is the seat of the State Industrial Reformatory and a normal college. Population 1900, 6,053.

**HUNTINGDONSHIRE**. See **HUNTINGDON COUNTY**, Vol. XII, pp. 397, 398.

**HUNTINGTON**, a city and the capital of Huntington County, northeastern Indiana, on both sides of Little River, and on the Chicago and Erie and the Wabash railroads, 25 miles S.W. of Fort Wayne. This is the center of the famous Huntington whitelime-burning region, fifty kilns being constantly in operation. There are several factories for working wood into various shapes, railroad-shops, a woolen-mill and other manufactories. The city has water-works, electric lights and a public library. Population 1890, 7,328; 1900, 9,491.

**HUNTINGTON**, a village of Suffolk County, southeastern New York, on Huntington Bay, and on the Long Island railroad, 38 miles from New York City. Bricks, pottery and thimbles are made here, and the place is a fashionable summer resort. Located here are an academy and a public library, the ruins of British fortifications, and the town has a street-railway and water-works. Population 1890, 3,028; 1900, 7,689.

**HUNTINGTON**, a city of Cabell County, western West Virginia, on the Ohio River, and on the Chesapeake and Ohio and the Ohio River railroads, 46 miles W. of Charleston. It has manufactories of car-wheels, lumber, glass, cigars and iron castings, a state normal school, and it is the seat of Marshall College. Coal, iron, lumber and salt are shipped. Population 1890, 10,108.

**HUNTINGTON**, COLLIS P., capitalist and railway magnate, was born in Litchfield, Co., Conn., Oct. 22, 1821, and died at his camp in the Adirondacks, Aug. 13, 1900. In 1848, when gold was discovered on the Pacific coast, Mr. Huntington proceeded thither by way of Panama and settled at Sacramento, where he went into business. One day he was approached by Leland Stanford, who suggested the construction of an overland railway. In June, 1861, the Central Pacific R. R. was organized, with a capital of \$8,500,000. The development of this line, the Southern Pacific R. R., and other profitable enterprises, returned large fortunes to Mr. Huntington, and with his steamship ventures, etc., ultimately made him a multi-millionaire.

**HUNTINGTON**, DANIEL, an American painter; born in New York, Oct. 14, 1816. He studied painting under Prof. S. B. F. Morse at the National Academy of Design, and produced *The Barroom Politician*; *A Topper Asleep*; and

some landscapes in 1835. In 1839 he went to Italy; there he painted *The Sibyl*; *Early Christian Prisoners*; and other works. After returning to New York he painted many portraits and some historical scenes, such as *Queen Mary Signing the Death-Warrant of Lady Jane Grey*. In 1851 he visited England, and in 1882 Spain. He was president of the National Academy almost continuously from 1862 to 1891. Among his portraits are ones of Presidents Lincoln and Van Buren, William Cullen Bryant, and Louis Agassiz.

**HUNTINGTON**, FAYE. See **FOSTER**, MRS. ISABELLA H., in these Supplements.

**HUNTINGTON**, FREDERICK DAN, an American theologian; born at Hadley, Massachusetts, May 28, 1819. He was at first a Unitarian pastor of a church at Boston. In 1855 he was chosen professor of Christian morals at Harvard College. His theological views then underwent a gradual change, and finally, in 1860, he entered the Episcopal Church. In 1864 he became rector of Emmanuel Church in Boston, and in 1869 was elected and consecrated bishop of central New York, locating at Syracuse. In 1861 he helped to found the *Church Monthly*; and published *Lessons on the Parables* (1856); *Christian Believing and Living* (1860); a pamphlet on strikes (1891); also many other articles and pamphlets.



BISHOP HUNTINGTON.

**HUNTINGTON**, SAMUEL, an American statesman; born at Windham, Connecticut, July 3, 1731. He learned the trade of a cooper, but became a lawyer in 1758, after which he was made king's attorney and also associate judge of the superior court of Connecticut. He was a signer of the Declaration of Independence. From 1779 to 1781 he was president of the Congress, and in 1784 he became chief justice of Connecticut. In 1785 Huntington was elected lieutenant-governor of Connecticut, and in 1786 he became governor of that state, which office he retained until his death. He died at Norwich, Connecticut, January 5, 1796.

**HUNTSVILLE**, a city and the capital of Madison County, central northern Alabama, called, on account of its beautiful situation on a spur of the Cumberland Mountains, and because of its enterprise, the "Queen City of the Mountains." It is on the Nashville, Chattanooga and St. Louis and the Memphis and Charleston railroads. It has a brass and iron foundry, railroad machine-shops, cotton and cottonseed-oil mills, an ice factory and lumber-mills. It contains an institute and business college for men, a state normal school, a Methodist Episcopal college and a Presbyterian Seminary, both for women, and a normal school for colored pupils. It has gas and elec-

tric lights and city water. Population 1880, 4,977; 1890, 7,995; 1900, 8,068.

**HUNTSVILLE**, a town and the capital of Randolph county, northern central Missouri; on the Wabash Railroad, five miles W of Moberly. It has a college for both sexes, and in the vicinity are flour-mills, a woolen-mill, machine-shops, a rake and stacker factory, a tobacco factory and coal-mines. Population 1900, 1,805.

**HUNTSVILLE**, a city and the capital of Walker County, southeastern Texas, on the International and Great Northern Railroad, 70 miles N. of Houston. It is in a cotton, lumbering and stock-growing section; has the state prison, where clothing, carriages and wagons, etc., are manufactured; the Sam Houston State Normal School, which has 320 students, Andrew Female Seminary and Austin College. The place has also corn-mills, cotton-gins, and ice and other manufactories. Population 1900, 2,485.

**HUNYADY, JÁNOS**. See **HUNGARY**, Vol. XII, pp. 367, 368.

**HUPEH** OR **HOOPEH**, a province of central China, between lat. 29° and 33° N., and long. 108° and 116° E.; one of the richest and most fertile provinces of China, being well watered by the Yang-tse-Kiang and its tributaries. It is rich in several minerals, among them coal; has an area of 70,000 square miles and a population of over 33,000,000. Its capital is Wu-Chang, one of the largest trading centers in China.

**HURA**, a tropical American genus of the family *Euphorbiaceæ*. *H. crepitans* is a tree, well known from the fact that its large woody capsule explodes with a loud detonation, and called by the natives the "monkey's dinner-bell." The name "sand-box tree" refers to the fact that the capsules were used to make sand-boxes.

**HURD, JOHN CODMAN**, an American author and traveler; born in Boston, Nov. 11, 1816. Between 1840 and 1887, Mr Hurd made extensive journeys in India, China, Japan and Egypt. He took an active interest in the theory of American politics, and contributed, on this and kindred subjects, several works of recognized value. He wrote *The Law of Freedom and Bondage in the United States* (1858); *The Theory of Our National Existence as Shown by the Action of the Government of the United States Since 1861* (1881).

**HURLBUT, JESSE LYMAN**, an American clergyman and author; born in New York City, Feb. 15, 1843; received his education at Wesleyan University; became a Methodist Episcopal minister, and held several pastorates in New Jersey and New York; in 1879 was agent of the Methodist Sunday School Union; and in 1884 assistant editor of Sunday school literature. He held various other offices under the church, and published several books; among them, *Manual of Biblical Geography* (1882); *Studies in the Four Gospels* (1889); and *Outlines in Old Testament History* (1890).

**HURLBUT, STEPHEN AUGUSTUS**, an American general and politician; born in Charleston, South Carolina, Nov. 29, 1815. He entered the volunteer service early in 1861, and became brigadier-

general, was promoted major-general after Shiloh, and succeeded General Banks in command of the department of the Gulf. General Hurlbut was minister to the United States of Columbia from 1869 to 1872; served in Congress from Illinois, from 1873 to 1877; and in 1881 was appointed minister to Peru, where he died a year later, March 27, 1882.

**HURLEY**, a village and the capital of Iron County, northern Wisconsin, on the Montreal River, and on the Chicago and Northwestern and the Wisconsin Central railroads, 38 miles E. of Ashland. Iron-ore and lumber are extensively shipped. The village has an academy. Population 1890, 2,267.

**HURLSTONE, FREDERICK YEATES**, an English painter; born in London in 1801; was trained at the Royal Academy, which he joined in 1820; traveled in Italy and Spain. His paintings are mostly scenes in southern Europe and illustrations of Byron and other poets. He was president of the Society of British Artists for 34 years, and exhibited almost exclusively in its gallery. Among his best known works are *The Prisoner of Chillon*; *Constance and Arthur*; *Italian Peasant Boys*; and *Boabdil's Farewell to Granada*. He died in London in 1869.

**HURON**, a city and the capital of Beadle County, eastern central South Dakota, on the James or Dakota River, and on the Chicago and North-Western and the Great Northern railroads. On account of its situation and railroad facilities, it is a leading commercial center of the state. The region is rich and prosperous. The city has an excellent system of public schools, a complete equipment of water-works and electric lights, and many handsome commercial buildings and private residences. The city contains a United States land-office, and a United States weather-station, railroad repair-shops, and manufactories of ornamental wood-work, flour, carriages and wagons, and cigars. Population 1890, 3,038; 1900, 2,703.

**HURON, LAKE**. See **ST. LAWRENCE**, Vol. XXI, pp. 178, 182.

**HURONIAN SYSTEM**. See **GEOLOGY**, Vol. X, p. 328.

**HURON INDIANS**, a tribe of North American Indians who were known to the French pioneers as Hurons, but who called themselves Wendats, or Yendats, or Wandots, or Wyandots. The tribe was known throughout colonial times as the Huron, but since 1751 has borne the name Wyandot. The Hurons lived in the lake region of Ontario, where they were in constant warfare with the more powerful Iroquois, by whom they were almost exterminated in the middle of the seventeenth century and driven westward in the Lake Superior region. The Jesuit missionaries under Marquette gathered the Hurons together at Mackinaw in 1670. The last appearance of the Hurons in warfare was at Detroit in 1812, under the British. Gradually the tribe now known as the Wyandot was driven westward, until in 1832 they were given a reservation in Kansas, on the present site of Kansas City, Kansas. From there the larger part of the tribe

was moved to the Indian territory on the Quapaw Reservation, where, in 1895, they numbered 297. A few who remained in Ontario are gathered near Quebec. See *Wyandot*, under INDIANS, Vol. XII, p. 827.

**HURRICANES.** See METEOROLOGY, Vol. XVI, pp. 154, 155, 180, 181; WEST INDIES, Vol. XXIV, p. 511; POLYNESIA, Vol. XIX, pp. 421, 422.

**HURST, JOHN FLETCHER**, an American Methodist Episcopal bishop; born near Salem, Maryland, Aug. 17, 1834. He studied theology at the Universities of Halle and Heidelberg, Germany. Having returned home in 1858, he was pastor of Methodist churches in Passaic and Elizabeth, New Jersey, till 1866, after which he took charge of the Methodist missionary institute at Bre'nen, Germany. Here he remained for three years, as teacher and director of the institute.



JOHN FLETCHER HURST.

In 1871 he again returned to the United States, became professor of historical theology at the Drew Seminary, in Madison, New Jersey, and in 1873 was made president of that institution. In 1880 he was elected bishop at the General Conference at Cincinnati. He published a *History of Rationalism* (1865); *Outlines of Bible History* (1872); *Martyrs of the Tract Cause* (1873); *Life and Literature in the Fatherland* (1874); *Bibliotheca Theologica* (1883); *Short History of the Reformation* (1884); *The Country and People of India and Ceylon* (1891); and several others.

**HURTER, FRIEDRICH EMANUEL VON**, a Swiss historian; born at Schaffhausen, Switzerland, March 19, 1787. He studied theology at Göttingen and became a minister at Schaffhausen in 1824, but resigned in 1841, and embraced Catholicism in 1844; two years afterward he was appointed historiographer to the Emperor of Austria. Some of his works are *Geschichte des Ostgothischen Königs Theodorich und seiner Regierung* (1807); *Geschichte Kaiser Ferdinands II und seiner Eltern* (1862); *Geburt und Wiedergeburt* (1845). He died at Gratz, Aug. 27, 1865.

**HUSBANDRY, PATRONS OF.** See FARMERS' ORGANIZATIONS, in these Supplements.

**HUSH OR HUSI.** See HUSCH, Vol. XII, p. 402.

**HUSSEY'S REAPER.** See HARVESTING MACHINERY, in these Supplements.

**HUTCHINS, THOMAS**, an American geographer; born in Monmouth, New Jersey, in 1730; was in the British service as engineer until the Revolution, when he was imprisoned in 1779 on account of his American sympathies. On his release he became geographer-general on the staff of General Greene in South Carolina. Besides other works he published *A Topographical Description of Virginia, Pennsylvania, Maryland and North Carolina* (1778); *History, Narrative and Topographical Description of*

*Louisiana and West Florida* (1784). He died in Pittsburg, Pennsylvania, April 28, 1789.

**HUTCHINSON**, a city, railroad center and the capital of Reno County, southern central Kansas, situated on the Arkansas River, and on the Atchison, Topeka and Santa Fé, the Chicago, Rock Island and Pacific, the Hutchinson and Southern and the Missouri Pacific railroads. It has a state reformatory, electric lights, Holly water-works, street-railroads and a telephone system. The surrounding country is an agricultural one, but it also has great beds of pure rock-salt, which is extensively mined. Sorghum sugar, flour, starch, soda, barbed-wire, soaps, ice and carriages are manufactured. It was founded in 1871. Population 1900, 9,379.

**HUTCHINSON, ANNE**, an American religious enthusiast; born at Alford, Lincolnshire, England, in 1591. She was the daughter of a clergyman, and married Edward Hutchinson. In 1634 she removed to New England. Her doctrine was that those who were in the covenant of grace were entirely freed from the covenant of works. She gave lectures twice a week, which were well attended. Her adherents were called "Antinomians," and included many prominent men, as Sir Henry Vane, the governor, and the powerful preacher Cotton. Boston was soon divided into two hostile theological camps. Mrs. Hutchinson was then tried for heresy and sedition and banished from Massachusetts, with several of her followers. She then bought, for forty fathoms of wampum, the island of Aquidneck from the Narragansett Indians, and founded the town of Portsmouth. After the death of her husband in 1642, she left Rhode Island and settled upon some land to the west of Stamford, Connecticut, then supposed to be within the territory of the New Netherlands. There, in the following year, she was cruelly murdered by Indians, together with her family, sixteen victims in all.

**HUTTON, FREDERICK REMSEN**, an American mechanical engineer; born in New York City, May 28, 1853; was educated in Columbia College and in the mining school of the same institution; received an instructorship and was assigned in 1891 to the professorship of mechanical engineering of the School of Mines. He did much work for the government, especially in 1880-82, when he prepared census monographs on machine-tools, wood-working machines, steam-pumps and pumping-engines. He was elected secretary of the American Society of Mechanical Engineers in 1883.

**HUTTON, LAURENCE**, an American author; born in New York City, Aug. 8, 1843. He was educated in New York and spent part of each year abroad; wrote for the press from an early age, and contributed much to periodicals.

He was for some time dramatic critic on the *New York Evening Mail*, and in 1886 became editor of



LAURENCE HUTTON

*Literary Notes in Harper's Magazine*. He published *Plays and Players* (1875); *Artists of the Nineteenth Century*, with Clara Erskine Clement (1879); *Actors and Actresses of Great Britain and the United States*, with Brander Mathews (1886); *Literary Landmarks of London* (1885); *Literary Landmarks of Edinburgh* (1890); *Edwin Booth* (1893); *Portraits in Plaster* (1894); *Literary Landmarks of Jerusalem* (1895); *Other Times and Other Seasons* (1895); etc.

HUTTON, RICHARD HOLT, an English journalist and critic; born in 1826; took up journalism and became editor of the *London Spectator*; published *Essays, Theological and Literary* (1871); *Essays on Some Modern Guides of English Thought in Matters of Faith* (1887); and *Life of Scott* (1878). He died Sept. 9, 1897.

HUTTON, WILLIAM RICH, an American civil engineer; born in Washington, District of Columbia, March 21, 1826. He was educated at private schools in Washington; was engaged on government undertakings at different times; and was a member of the Society of Civil Engineers of France; was either directing or consulting-engineer in many important works, among them being the Washington aqueduct 1863, the Chesapeake and Ohio canal 1869-72, and the Hudson River tunnel.

HUXLEY, THOMAS HENRY, an English naturalist and philosopher; born in Ealing, a suburb of London, England, May 4, 1825. His early education was obtained in the school in which his father taught. Lack of means deprived him of the advantages of a university training, but he progressed rapidly, through his own efforts. His reading covered a wide range of topics, and his first choice of a calling was that of a mechanical engineer. Circumstances turning him



PROF. T. H. HUXLEY.

toward medicine, he studied for three years at Charing Cross Medical School, and received in 1845 the degree of M.B. from the University of London, with high honors in physiology. His ambition was to obtain a post as professor of physiology, but in this he met with disappointment. Soon after graduating in medicine he received an appointment as assistant surgeon on H.M.S. *Rattlesnake*, and spent four years in the South Pacific. In this cruise he visited various parts of Australasia, and sent home several papers upon marine biology. One of them, on the *Affinity of Oceanic Hydrozoa*, was published by the Royal Society, and resulted in making him a fellow of the society upon his return in 1851. In 1854 he was appointed Fullerian professor of physiology in the Royal Institute, and also professor of natural history in the Royal School of Mines, connected with the Geological Survey of England, which post he held for 31 years. After the appearance of Charles Darwin's *Origin of Species* in 1859, he became a warm and able defender of the doctrine of organic evolution, during which his remarkable gifts for leadership speedily became recognized.

In 1869 he was made president of the Geological Society; in 1870 president of the Ethnological Society, president of the British Association for the Advancement of Science, and a member of the Royal Commission on Scientific Instruction. In 1873 he was made secretary of the Royal Society, and ten years later was elected its president, the highest honor attainable by an Englishman of science. Public offices and a shower of honors and degrees fell upon him, many of them from foreign societies and governments. Failing health compelled him, in 1885, to resign all offices, including the presidency of the Royal Society. But during the next ten years it seemed as though freedom from official duties but liberated his mind and his pen. Addresses upon scientific, literary and philosophical subjects, together with essays and reviews, kept him constantly before the public, adding to his reputation for extensive knowledge and argumentative vigor.

Among scientists Professor Huxley is known as a great zoölogist—Haeckel places him before all other Englishmen in that branch. Among the more important of his contributions to the literature of zoölogy are *Oceanic Hydrozoa* (1859); *Theory of the Vertebrate Skull* (1859); *Anatomy of Vertebrated Animals* (1871); and *Anatomy of Invertebrated Animals* (1877). Naturally some of these works are so purely technical that scientists alone can properly appreciate them; but, among men of letters, theologians and laymen generally, he obtained recognition as a scientist of unusual powers, marvelous controversial gifts and great versatility.

In his theological controversies with the Duke of Argyll, Mr. Gladstone and others, he gave a clear meaning to the term *agnostic*—a term to which he himself gave currency as applying to any person who refuses to adopt a statement which is not susceptible of scientific proof. That he was not a pure materialist he demonstrated in his *Physical Basis of Life* (1868), and for Comte and the entire positivist school he had a profound dislike. The best known of his works are the ones wherein his marvelous lucidity of style and acute reasoning powers are made use of to render abstruse scientific problems intelligible to the masses. Of these, his *Man's Place in Nature* (1863); *Elementary Physiology* (1866); and *Lay Sermons* (1870), are the most popular.

Huxley's life was lived and his work was performed during the storm and stress period of the struggles of modern science. Prejudices of the ignorant and of conservative or bigoted sectarians opposed its advance from every quarter, during which Huxley stood out fearlessly and foremost as an enthusiastic believer in and champion of the Darwinian theory of natural selection. Such an attitude required not only thorough belief, but great courage and firmness. He lived through the storm, and saw evolution recognized as a working hypothesis by nearly all scientists. His tenacity of purpose (some have termed it obstinacy), his acute powers of perception and his perfect integrity of thought and action are the most marked of his characteristics. His life-purpose can be best stated in his own words: "The objects which I have ever had in view have been to promote the increase of natural knowledge,

and to forward the application of scientific methods of investigation to all the problems of life to the best of my ability, in the conviction—which has grown with my growth and strengthened with my strength—that there is no alleviation for the sufferings of mankind except veracity of thought and action, and the resolute facing of the world as it is, when the garment of make-believe by which pious hands have hidden its uglier features is stripped off.”

When, in the future, the qualities of those who have led in the intellectual progress of our century are summed up, it cannot be doubted that he will hold rank upon at least as high a level as such great original investigators as Faraday, Darwin, Le Verrier, Lyell and Humboldt; while none will be found more deserving of admiration for qualities of fearlessness and truth. Professor Huxley is the author of articles in this *ENCYCLOPEDIA ON ACTINOZOA; AMPHIBIA; ANIMAL KINGDOM; BIOLOGY; EVOLUTION*; besides which, and the others of his works already mentioned, the more important of his works are *Introduction to the Classification of Animals* (1869); *Physiography* (1877); *Introduction to Zoölogy* (1879); *Science and Culture* (1882). He died at Eastbourne, on the Sussex coast, June 29, 1895. An interesting account of Huxley appeared in 1900 in his *Life and Letters*, edited by his son.

**HUYDECOPER** BALTHASAR, a Dutch author and scholar; born in Amsterdam, Holland, 1695. He held many distinguished offices, but it is as a writer who has done much to purify and enrich the Dutch language that he is best known. He wrote *Proeve van Taal-en Dichtkunde, in Veijmodige Aanmerkingen op Vondels Virtaalde Herscheppingen van Ovidius* (1730) and an edition of the *Rijmkronijk van Melis Stoke, met Historie-Oudheid en Taalkundige Aumerkingen* (1772), both of which are learned books. He tried poetry and dramatic writing, but they were notable chiefly for the rhetorical ability displayed, although one, *Achilles*, was long a favorite. He died in Amsterdam, Sept. 21, 1778.

**HUYSMANS**, JORIS KAHL, a French novelist; born in Paris, Feb. 5, 1848. For some time he held a position in the Department of the Interior, but later devoted himself entirely to literature, particularly cultivating the field of the short story and novel. He displayed a rapidly increasing tendency toward naturalism in *Le Dracoir aux Épices* (1874); *Les Soirées de Médan* (1879); *En Ménage* (1881); and *À Vau-l' Eau* (1883). But in *À Rebours* (1885), he turns from naturalism toward a sort of uncertain spiritualism, which he kept up in *Là-bas* (1889).

**HVITFELD**, ARILD, a Danish historian; born in 1549; was at one time a Senator (1586); and afterwards Chancellor of the kingdom. He compiled the *Lives of Danish Kings*, beginning with Christian III and working back to earlier times; but it is as author of a *Chronicle of the Kingdom of Denmark* that he is most noted, the work being exceptionally useful to students of Danish history. He died in 1609.

**HWANG—HO** OR **HOANG—HO**. See *CHINA*, Vol. V, pp. 630, 631.

**HYACINTHE**, PÈRE. See *LOYSON*, CHARLES, in these Supplements.

**HYALEA**. See *MOLLUSCA*, Vol. XVI, p. 366.

**HYALINE**, a newly manufactured composition, described as horny, translucent, possessing great tensile strength, and having considerable elasticity. It is used as a substitute for celluloid, and can be worked, dyed, pressed, denitrated and rendered incombustible or fire-proof. It is composed of about equal parts of gun-cotton and colophony, or shellac, copal, dammar, turpentine, or of any mixture of any of these resins.

**HYALITE** OR **MULLER'S GLASS**. See *MINERALOGY*, Vol. XVI, p. 390.

**HYANNIS**, a post village and seaport of Barnstable County, Massachusetts, on the south side of Cape Cod, and on a branch of the New York, New Haven and Hartford railroad, 79 miles from Boston. It has a high school, an iron-foundry, a shoe factory and several churches. Its outer harbor is protected by a breakwater, and has a fixed light with an elevation of seventy feet above the level of the sea. Population 1895, 1,237.

**HYATT**, ALPHEUS, an American naturalist; born in Washington, District of Columbia, April 5, 1838; studied at Yale and the Lawrence Scientific School; was connected with the Essex Institute, Peabody Academy of Science as curator, and was a member of most of the scientific societies in the United States. In 1887 he became professor of zoölogy and palæontology in the Massachusetts Institute of Technology. His principal works are *Fresh-Water Polyzoa; Genera of Fossil Cephalopods* (1883); *Larval Theory of the Origin of Cellular Tissue* (1884); *Genesis of the Arctide* (1889). He accomplished much work on the fossil cephalopoda, of great value to the evolutionist. The first and only monograph on American sponges is his *Revision of the North American Porifera*. He wrote a series of small books for use in the public schools, entitled *Guides to Science-Teaching*.

**HYDASPES**. See *KASHMIR*, Vol. XIV, p. 10; and *ALEXANDER THE GREAT*, Vol. I, p. 484.

**HYDE**, ANNE. See *CLARENDON*, Vol. V, p. 806.

**HYDE**, EDWARD. See *CLARENDON*, Vol. V, pp. 804, 809.

**HYDE DE NEUVILLE**, JEAN GUILLAUME, a French statesman; born at La Charité-sur-Loire, Jan. 24, 1776. He was an extreme royalist, and, after engaging in several unsuccessful schemes for restoring the Bourbons, went to the United States, where he remained until after the restoration. He was a Deputy in 1815, and from 1816 to 1821 was minister to the United States; was minister to Portugal in 1824, and in 1828 became Minister of the Navy. In 1830 he retired from public affairs on the accession of Louis Philippe. He was created baron in 1821. He died in Paris, May 28, 1857.

**HYDE PARK**, an inclosure of nearly four hundred acres, which is one of the most popular pleasure parks in London. It adjoins Kensington Gardens. It derives its name from having been the manor of Hyde, belonging to the Abbey of Westminster. See *LONDON*, Vol. XIV, p. 824, and in these Supplements.

**HYDE PARK**, a district of Chicago, Illinois, annexed in 1889, within which is the University of

Chicago; and Jackson and Washington parks, the first-named being the site of the World's Columbian Exposition.

**HYDE PARK**, a town in Norfolk County, eastern Massachusetts, on the Charles and Neponset rivers, and on branches of the New York, New Haven and Hartford railroad; seven miles S. of Boston. It has excellent graded schools, a public library and various manufactories. It is chiefly a place of residence for persons who carry on business in Boston. Population 1890, 10,193; 1900, 13,244.

**HYDE PARK**, a village in Dutchess County, on the Hudson River, New York, about 80 miles N. of New York City, and on the New York Central and Hudson River railroad. It is beautifully situated and is a favorite place of residence. The town (1900) had a population of 2,806.

**HYDE PARK**, a village in northern Vermont, capital of Lamoille County, on the Lamoille River, and on the St. Johnsbury and Lake Champlain railroad, 23 miles N. of Montpelier. It has carriage, lumber and other industries. It has a copper-mine, limestone-quarry, beds of mineral paint, saw-mills, good water-power, much timber, and it is the seat of Lamoille Central Academy. The surrounding country is famous for its exceptional beauty. The population in 1900 was 1,472.

**HYDRA**, in Greek mythology, a monster, the offspring of Typhon and Echidna, brought up by Juno (Elera). It dwelt in a swamp, and ravaged the country of Lerna near Argos. It had nine heads, the middle one being immortal. Hercules struck off its heads with his club, but in the place of each head cut off, two new ones grew forth. With the assistance of his servant Iolaus, Hercules burned away the heads of the Hydra, and buried the ninth or immortal one under a huge rock. After thus conquering the monster he poisoned his arrows with its bile, in consequence of which the wounds inflicted by them became incurable.

**HYDRA**. See *Hydroida*, under **HYDROZOA**, Vol. XII, pp. 560, 561; and **PHYSIOLOGY**, Vol. XIX, pp. 16-19.

**HYDRASTIS CANADENSIS**, a common herbaceous plant of early spring, indigenous in the United States in rich woods throughout the middle and central states. It belongs to the family *Ranunculaceæ*, or crowfoots. It sends up a broad five to seven lobed root-leaf, and a stem about one foot high, bearing one or two small leaves just below the solitary flower. The sepals fall off in the bud, leaving a cluster of white stamens and a head of carpels, the latter maturing into a fruit resembling a raspberry. On account of its yellow root-stock it is known as orange-root or yellow puccoon.

**HYDRATE OF CHLORAL**. See **CHLORAL**, Vol. V, pp. 677, 678.

**HYDRATES**, a name sometimes given to hydroxides, but should be confined to those compounds formed by the addition of water to other substances, in which the water retains to some extent its individuality, and is easily driven off by heating a little above its boiling-point. Chlorine, for instance, forms at low temperatures a solid hydrate which

decomposes at ordinary temperatures. See **CHEMISTRY**, Vol. V, pp. 556-562.

**HYDRAULIC CRANE**. See **CRANE**, Vol. VI, pp. 547, 548.

**HYDRAULIC ELEVATORS**. See **LIFTS**, Vol. XIV, pp. 574-576.

**HYDRAULIC MACHINERY**. The tendency to use hydraulic power for operating large machines has kept pace with the use of individual electric motors and compressed-air apparatus, all of them coming more into use as improvements over the older methods of conveying power by gearing, belts or other mechanical means. Hydraulic power has special advantages which render it more suitable than anything else for certain lines of work. Where enormous power is required for only short intervals, this is usually the form preferred, since it costs nothing while idle. That remarkable mechanism, the Emery testing-machine, which is capable, in the larger sizes, of exerting a pressure of one million pounds, would not have been possible without hydraulic mechanism. The massive dock-gates built within a few years in several European cities are moved invariably by hydraulic apparatus. It has come into general use for riveting-machines, because the final pressure exerted is the greatest, which is exactly what is wanted in riveting. Punching and shearing machines of large size are now made to operate almost wholly by hydraulic pressure, because it has been found that the geared machines break down much more frequently, owing to the sudden strains.

Large hydraulic presses (see **CALENDER**, Vol. IV, p. 683) for forming wrought-iron and steel are, to some extent, taking the place of the steam-hammer. (See **HAMMER**, Vol. XI, p. 426.) They are built of a capacity up to four thousand tons, and will take in the largest forgings. A mammoth press which has been put in at the Bethlehem (Pennsylvania) Iron Company's works commonly exerts a pressure of six tons to the square inch, and has occasionally been used with a pressure of twenty tons to the square inch. Nearly all the heavy machinery in large steel-works is now operated hydraulically. The most recent electrotypers' presses are built for this power. The wheel-presses with which car-wheels are forced on and off their axles use hydraulic mechanism; so, also, the gigantic coining-press at the Philadelphia mint, which is capable of exerting a pressure of two million pounds.

The use of the hydraulic shield in tunneling operations has increased steadily since its introduction in 1869. As used in the St. Clair River tunnel at Sarnia, on the Grand Trunk railway, it consisted of a cylindrical shield 21½ feet in diameter and 15¼ feet long. This was formed of one-inch steel-plate, and was forced forward by the application of a series of hydraulic jacks pressing against its rear edge. As the total pressure from the jacks was three thousand tons, no difficulty was experienced in pushing aside small bowlders. The advances were made in stages of a foot and a half, and if there was any tendency to work out of line, it was corrected at once by applying more force from the jacks on one side. This shield was built with rear doors, forming locks, so

that the workmen might escape if accident should flood the entrance. The Blackwall tunnel, in course of construction in 1896, under the Thames, in London, employed a shield of 27 feet diameter. Within this are four levels for the workmen to stand upon, and to prevent sand and loose dirt from falling too far into the shield. The hydraulic jacks are supplied with water by steam-pumps, which are moved forward as the work progresses. The jacks are supported in the rear by pressing against the metal rings which form the body of the tunnel. When the shield is pushed forward one stage, the hydraulic jacks are moved up and one more ring added to the tunnel. After this is in place, the jacks again are braced in position, and the work proceeds. The jacks, of course, are spaced equidistant around the circumference of the shield; but in order to provide for unequal pressure, there are separate valves for each jack, allowing the pressure to be distributed as found desirable. The hydraulic shield is now the standard apparatus for tunneling, where the nature of the ground permits its use.

C. H. COCHRANE.

**HYDRAULIC PRESSES.** See IRON and STEEL, in these Supplements.

**HYDRAULIC PROPULSION.** See MOTORS, in these Supplements.

**HYDRAULIC RAM.** See HYDRO-MECHANICS, Vol. XII, pp. 532, 533.

**HYDRAULICS.** See HYDRO-MECHANICS, Vol. XII, pp. 459-535.

**HYDRAZINE.** See CHEMISTRY, in these Supplements.

**HYDRAZOIC ACID.** See CHEMISTRY, in these Supplements.

**HYDROCARBONS,** compounds containing only carbon and hydrogen. They occur in many plants as essential oil or wax, in petroleum, in natural gas, and are formed by the dry distillation of coal and many other substances. They are insoluble or little soluble in water, and are neutral bodies, some very stable, others easily acted on. Almost all petroleum products (gasoline, benzine, coal-oil, vaseline, paraffine) are hydrocarbons. Benzine, toluene, naphthalene and anthracene are used to make artificial dyes. Acetylene is used as a substitute for coal-gas, the luminosity of which is, however, largely if not entirely due to hydrocarbons. Toluene and some others are used in medicine, naphthalene for keeping out moths, and so a hundred other uses to which they are put might be given. See CHEMISTRY, Vol. V, pp. 556-562.

**HYDROCELE** (Gr., *hydor*, "water," and *kèle*, "a swelling"), a dropsy of the tunica vaginalis, the serous membrane investing the testis. It occurs as a smooth, pear-shaped swelling, painless, but sometimes causing uneasiness from its weight. The quantity of fluid in the sac may amount to forty ounces. Hydrocele most commonly comes on without any apparent local cause, and is most frequently met with about or beyond the middle period of life, and generally in persons of feeble power; sometimes, however, it occurs in young children. The treatment may be palliative or curative. The palliative treatment consists in

the use of suspensory bandages, and tapping from time to time. The curative treatment consists in setting up inflammation in the tunica vaginalis by the injection of tincture of iodine, so as to obliterate the cavity, or by excision of the whole or part of the sac.

**HYDROCHLORIC ACID,** called also CHLORO-HYDRIC. See CHLORINE, Vol. V, p. 678.

**HYDROCHÆRIDÆ,** a family of South American rodents, represented by only one species, the capybara (*Hydrochærus*). The capybara, or water-pig, is the largest living rodent. See CAPYBARA, Vol. V, p. 80.

**HYDROCOTYLE,** a genus of umbelliferous plants, having simple umbels, flattened, more or less orbicular fruit, and simple rounded leaves, either kidney-shaped or peltate. The species are numerous, growing in water or wet places, and mostly with creeping or rooting stems.

**HYDROCYANNIC ACID.** See PRUSSIC ACID, Vol. XX, pp. 22-25.

**HYDRODYNAMIC ENGINES.** See HYDRO-MECHANICS, Vol. XII, pp. 520, 521.

**HYDRODYNAMICS.** See HYDRO-MECHANICS, Vol. XXII, pp. 445-458.

**HYDROFLUORIC ACID.** See FLUORINE, Vol. IX, p. 349.

**HYDROGEN, LIQUEFACTION OF.** When hydrogen is surrounded by nitrogen boiling in a vacuum it may be condensed to a colorless liquid. At ordinary pressure it boils at  $-243.5$  and its critical temperature is  $-234.5$ , so that it cannot be liquefied at any pressure above  $-234.5$ . Liquid hydrogen may be used to obtain the lowest temperatures yet reached.

**HYDROGEN PEROXIDE,** a compound of hydrogen and oxygen usually obtained in solution by the action of a dilute acid on barium peroxide. The solution may be concentrated to fifty per cent in the air, and then by distillation in a vacuum the pure hydrogen peroxide obtained as a water-clear, syrupy liquid with an acid reaction. It decomposes readily in contact with many substances, especially when heated. Discovered by Thenard in 1818, it seems to be extensively distributed in nature, though in minute quantity. The solution is usually sold as containing a certain number of volumes of available oxygen, on the theory that it decomposes into water and oxygen. Thus a ten-volume solution means one that may be made to give up ten times its volume of oxygen. It is used for bleaching silk, feathers and hair, as an antichlor, and in medicine as an antiseptic. See BLEACHING, Vol. III, p. 823; and CHEMISTRY, in these Supplements.

**HYDROGRAPHY.** See *Flow in Rivers and Canals*, under HYDRO-MECHANICS, Vol. XII, pp. 492-510.

**HYDROMINÆ.** See MAMMALIA, Vol. XV, pp. 418, 419.

**HYDROPHOBIA AND RABIES.** The researches of M. Louis Pasteur led him to the conclusion in 1884, that by inoculation with prepared virus absolute protection against rabies and hydrophobia could be secured. He considered rabies

a disease of parasitic origin, although the particular parasite was not isolated securely. His method of treating people bitten by mad dogs was as follows: He found that, if he exposed the spinal cords of rabbits affected by the rabies in glass jars which had been freed from all moisture by caustic potash, and were kept at a constant temperature of 23° C., these spinal cords lost in virulence with each day of such exposure until, after a period of fourteen days, no poisonous effect resulted from their inoculation into a healthy rabbit or dog.

An animal bitten by a mad dog, if inoculated daily with gradually stronger and stronger virus taken from the spinal cords of rabbits, was found to be proof against the outbreak of hydrophobia. Pasteur concluded that a person thus treated must likewise be proof against the disease. On July 7, 1885, when a boy, Joseph Meister, who had recently been bitten by a mad dog, presented himself at his laboratory, Pasteur inoculated him first with weak virus. Each succeeding day he inoculated him with a gradually stronger virus, ending this treatment on the 16th of June. The boy was cured, without any deleterious effects from the treatment.

After that time Pasteur performed hundreds of similar preventive inoculations. It is asserted generally that of 100 persons bitten by mad dogs, about 18 to 20 become rabid and die of hydrophobia. By Pasteur's treatment this percentage was reduced to one half, or even less. Some physicians, who were opposed to Pasteur, maintained that there was danger of death being caused by his inoculations, without reference to the effect of the dog's bite. An English commission investigated this point, but could not find a single case of death from this cause alone.

A large hospital, called the Pasteur Institute, was established in Paris and another in New York, where dog-bitten patients received treatment under Pasteur's personal supervision. Of the few who succumbed to the disease, it is asserted that there were other complications involved. The efficacy of the Pasteur system, which at first encountered much opposition came to be generally recognized. See Vols. XII, pp. 545-547 and Vol. XX, 199-202.

**HYDROPHYLLACEÆ**, a family of dicotyledonous plants, containing numerous species, natives chiefly of the colder parts of America. The order includes some small trees and bushes, as well as herbaceous plants, and is related most closely to the *Borraginaceæ*. The largest and best known genus is *Phacelia*.

**HYDROPTEREDÆ**, a family of cryptogams. See VEGETABLE KINGDOM, Vol. XXIV, p. 129.

**HYDRORHACHIS**. See MONSTER, Vol. XVI, p. 763.

**HYDROSTATICS**. See HYDRO-MECHANICS, Vol. XII, p. 435.

**HYDROTROPISM**, a term in physiological botany, indicating that certain plant-members are influenced in the direction of their growth by the presence of moisture. Roots are notably *positively*

*hydrotropic*; that is, a moist body causes them to turn toward it.

**HYDROXYLAMINE**. See CHEMISTRY, in these Supplements.

**HYGËIA** or **HYGIEIA**, in Greek mythology, the goddess of health and a daughter (or according to some traditions the wife) of Æsculapius, in whose temple she usually was worshiped. She was worshiped at Athens, Corinth, Argos and other important cities, and in works of art usually is represented as a virgin with a snake, the symbol of health, which drinks from a cup held in her hand.

**HYKSOS**. See EGYPT, Vol. VII, p. 735.

**HYLÆOSAURUS**, a genus of dinosaur, remains of which have been found in England. There were large spines along the median line of the back. The length of the animal has been estimated at 25 feet.

**HYLAS**. See ARGONAUTS, Vol. II, p. 496.

**HYLIDÆ**, the family of tree-frogs or tree-toads. Most species are arboreal. The toes are dilated into suckers at the extremities, thus enabling the animals to climb easily. These frogs are well known on account of their loud and peculiar voices. Many species are beautifully colored. *Hyla*, the typical genus, contains 175 species, mostly from tropical America. There are many similar forms in other countries. See FROG, Vol. IX, pp. 795, 797.

**HYLOBATES**. See APES, Vol. II, pp. 150, 151.

**HYMENOPHYLLACEÆ**. See FERNS, Vol. IX, p. 104.

**HYMETTUS**. See ATTICA, Vol. III, pp. 58, 59.

**HYNDMAN, HENRY MAYERS**, an English socialist; born in 1842, in England. He was educated at Trinity College, Cambridge, and entered the Inner Temple in 1863. He was special correspondent of the *Pall Mall Gazette* during the war between France and Italy in 1866, receiving the special thanks of his paper at the close of hostilities. He was a founder of the Social Democratic Federation, and was the author of *The Indian Famine and the Crisis in India* (1877); *England for All* (1881); *Historic Bases of Socialism in England* (1883); *The Social Reconstruction of England*; *Socialism and Slavery*; *A Summary of the Principles of Slavery*; and *Will Socialism Benefit the English People?* (1884).

**HYNOBIDÆ**, a family of salamanders composed of the genus *Hynobius*, peculiar to Japan. The affinities with the *Amblystomidæ* are so marked that some authors include *Hynobius* in this family.

**HYOID BONES**. See ANATOMY, Vol. I, p. 825.

**HYOPSODUS**, a small mammal, one of the Lemuroids, remains of which are found in Eocene formations in Wyoming.

**HYOSEYAMUS**. See HENBANE, Vol. XI, p. 650.

**HYPERBOLA**. See CONIC SECTIONS, Vol. VI, pp. 278-282.

**HYPERBOLOID**. See GEOMETRY, Vol. X, pp. 418, 419.



**HYPERICACEÆ**, a family of numerous species, trees, shrubs and herbaceous plants, widely distributed and in very different climates, but particularly numerous in North America. The species of *Vismia* yield a substance resembling gamboge. Many of the *Hypericaceæ* belong to the genus *Hypericum*.

**HYPERION**, a Titan of Greek mythology, son of Cœlus and Terra, and married to his sister Thia; was the father of Helios (Sol), Selene (Luna) and Eos (Aurora). The name is used as a patronymic by Homer, and his example is followed by later poets.

**HYPEROARTIA** AND **HYPEROTRETA**, the two orders of Marsipobranchs or Cyclostomes. In the *Hyperoartia* the nasal cavity is a blind tube, without connection with the pharynx. The order comprises the petromyzonids, or lampreys. In the *Hyperotreta* the nasal cavity connects with the pharynx through the palate. This order is composed of the myxinoids, or hog-fishes.

**HYPERSTHENE**. See **MINERALOGY**, Vol. XVI, p. 415.

**HYPNOTISM**. See **MAGNETISM, ANIMAL**, Vol. XV, pp. 277-283.

**HYPNUM**, a genus of mosses belonging to the family *Bryaceæ*, a group of the *Acrocarpi*, where capsules are borne terminally upon the main axis. Many species are remarkable for their beauty, and are often used for decorative purposes. Their distribution is universal. See **MUSCINEÆ**, Vol. XVII, pp. 70-73.

**HYPOCHÆRIS**, a genus of plants of the family *Compositæ*, of which one species (*H. radicata*) is common in meadows and pastures in Britain. Its rough leaves spread on the ground, and resemble in form those of the dandelion; the stem is branched; the flowers are like those of the dandelion, but smaller.

**HYPOCHLORITES** OR **BLEACHING-SALTS**. See **CHEMISTRY**, Vol. V, p. 494.

**HYPOGENE**. See **GEOLOGY**, Vol. X, p. 240.

**HYPONITROUS ACID**. See **CHEMISTRY**, Vol. V, p. 514.

**HYPOPHOSPHOROUS ACID**. See **CHEMISTRY**, Vol. V, p. 517.

**HYPOPHYSIS**. See **BOTANY**, Vol. IV, p. 155.

**HYPOPTHALMIDÆ**, a family of cat-fishes (Siluroids) peculiar to the rivers of South Amer-

ica. They resemble the cat-fishes of the United States.

**HYPOSULPHITE**, a salt of hyposulphurous acid, or frequently called simply hypo. It should be called sodium thiosulphate, as the true hyposulphites are rare, and not easily made. Sodium hyposulphite is used in photography as a solvent. See **SULPHUR**, Vol. XXII, p. 636.

**HYPOXANTHINE**, called also **SARCINE** OR **SARKINE** (C<sup>5</sup>H<sup>4</sup>N<sup>4</sup>O<sub>2</sub>) an immediate derivation of uric acid. It is a white crystalline powder found in the spleen, liver, muscles and other organs of man, and in the spleen and blood of the ox. See **NUTRITION**, Vol. XVII, p. 683.

**HYPOMETRY**. See **SURVEYING**, Vol. XXII, p. 713.

**HYRACEUM**, a blackish-brown viscid material, product of the South African hyrax, not unlike soft pitch, found in the crevices of the rocks of Table Mountain, Cape of Good Hope. It has an offensive taste, and is not unlike castoreum, for which it has served as a substitute in medicine.

**HYRACOIDEA**. See **MAMMALIA**, Vol. XV, p. 422.

**HYRTL, JOSEF**, an Austrian anatomist; born at Kis Márton, Hungary, Dec. 7, 1811; studied at Vienna, and acquired eminence as a scientific anatomist. He became professor of anatomy in Prague in 1837, and at Vienna in 1845. He contributed not a little to the progress of comparative anatomy, especially that of fishes, and made the anatomy of the ear a subject of very particular investigation. He produced many books and articles on the subjects above indicated. Hyrtl formed a museum of comparative anatomy at Vienna, and became rector of the university. He was the author of *Topographische Anatomie* (1847); *Handbuch der Praktischen Zergliederungskunst* (1860); *Ueber Ampullen am Ductus Cysticus der Fische* (1868); *Das Nierenbecken der Säugethäre und des Menschen* (1870); *Das Arabische und Hebräische in der Anatomie* (1879); *Die Alten Deutschen Kunstworte der Anatomie* (1884), and other works. He died in Vienna, July 17, 1894.

**HYSTERECTOMY** OR **CÆSAREAN OPERATION**. See **SURGERY**, Vol. XXII, p. 691.

**HYSTERESIS, MAGNETIC**. See **ELECTRICITY**, § 62, in these Supplements.

**HYSTRICIDÆ**. See **PORCUPINE**, Vol. XIX, p. 518.

## IABADIUS—ICARUS

**IABADIUS**, a large fertile island in the East Indies, described by Ptolemy. It was said to be near the Golden Chersonesus, and it produced much gold and grain. It is now thought to be identical with Java, but Humboldt took it to be Sumatra.

**IACCHUS** (*Greek, Iakchos*), a name for the god Dionysus at Athens and Eleusis. On the sixth day of the Eleusinian mysteries a decorated statue of Iacchus was carried from Athens to Eleusis, where the votaries were initiated into the last mysteries. Some think that Iacchus is identical with the Roman Bacchus, the son of Jupiter and Semele. See MYSTERIES, Vol. XVII, p. 188.

**IALYSUS**. See RHODES, Vol. XX, p. 526.

**IAMBIC METERS**, a meter in which the verse is composed of iambic feet. It was used originally in Greece for satirical writing, but afterward was employed in any case where pointed expression for a thought was wanted. See GREECE, Vol. XI, p. 139.

**IANTHINA**, a genus of gasteropod mollusks, typical of the family of purple shells or violet snails. They swim near the surface of the sea in warm waters. The foot secretes a gelatinous substance, full of air-bubbles, which hardens and forms a support for the eggs. This float remains attached, and does not allow the animal to sink below the surface. Great numbers are often blown ashore during storms. The shells are purple at the base and white at the apex.

**IAPETUS**, a satellite of Saturn. See TIDES, Vol. XXIII, p. 379.

**IATROCHEMISTRY**. See MEDICINE, Vol. XV, pp. 810, 811.

**IBEA**. See AFRICA, in these Supplements.

**IBERA** OR **YBREA**, a marshy lake in the province of Corrientes, eastern Argentine Republic, between the rivers Paraná and Uruguay. It averages 50 miles in length and 30 in width, though its size and shape vary much with the seasons.

**IBERIA**. See SPAIN, Vol. XXII, p. 304.

**IBERNIA**. See IRELAND, Vol. XIII, pp. 214, 272.

**IBERVILLE, PIERRE LE MOYNE, SIEUR**, a French-Canadian explorer, founder of Louisiana; born in Montreal, Canada, July 16, 1661. He entered the French navy as midshipman when 14 years old. In 1690 he was one of the leaders in the retaliatory expedition against Schenectady. In October, 1694, he captured Fort Nelson, on Hudson Bay. In 1696 he took nearly all of Newfoundland from the British, whom he defeated in the naval fights of 1697. In March, 1699, he entered the Mississippi River and ascended it as far as the mouth of the Red River. He then built old Fort Biloxi at the head of Biloxi Bay. This was the first post established in Louisiana.

After going to France and returning to Louisiana in 1701, he found the settlement reduced by disease, and thereupon transferred it to Mobile, thus beginning the colonization of Alabama. He also occupied Dauphin or Massacre Island. After being made captain of a line-of-battle ship, he captured, in 1706, the island of Nevis from the English. He was suddenly attacked by a malady, of which he died, at Havana, Cuba, July 9, 1706.

**IBSEN, HENRIK**, a Norwegian poet and dramatist; born at Skien, in southern Norway, March

20, 1828. In 1842 he was apprenticed to a chemist at Grimstad, but abandoned that business to devote himself to literature. In 1850 he became a student in Christiania University, but did not remain to complete the course. After two years of journalistic work he was appointed director of Ole Bull's theater at Bergen, for which he wrote *The Banquet at Sol-*



HENRIK IBSEN.

*haug* (1856) and *Lady Inger at Östrät* (1857), his first works of note. In 1857 he undertook similar duties for the National Theater in Christiania. His next dramas, *The Warriors in Helgeland* (1858), *Love's Comedy* (1862), and *The Rival Kings* (1864), placed him in the first rank of Scandinavian dramatists. He left Norway in 1864, and afterward lived abroad, chiefly in Rome, Dresden and Munich. The Norwegian Parliament granted him a pension in 1866. In that and the following year appeared the lyric dramas *Brand* and *Peer Gynt*, in many respects the finest things he produced. Other works are *Emperor and Galilean* (1873); *Pillars of Society* (1875); *A Doll's House* (1878); *Ghosts; An Enemy of the People* (1882); *The Wild Duck* (1884); *Rosmersholm* (1886); *The Lady from the Sea* (1888); *The Master Builder* (1892); and *Little Eyolf* (1894). His later plays aroused a storm of controversy in England in 1889, as they had done shortly before in Germany and in the Scandinavian countries. Up to that time he was practically unknown and unread in the United States, but he suddenly achieved an extraordinary popularity, and his plays were produced and his works perused in many sections of the country. Ibsen is a naturalist or realist, and writes for moral purposes. See also NORWAY, Vol. XVII, p. 591.

**ICA**, a river. See COLOMBIA, Vol. VI, p. 153.

**ICARIUS OF ATTICA**. See DIONYSUS, Vol. VII, p. 249.

**ICARUS**. See AERONAUTICS, Vol. I, p. 185.

**ICEBOATS AND BOATING.** The iceboat is built to go on runners, with which each end of its center and crossbeam is fitted. The machine is supplied with sails, and can attain great speed, a mile a minute being a common thing in a good breeze. In America the sport is enjoyed greatly on the Hudson, and in all Northern states on small lakes and rivers, and regattas are held every winter.

**ICE-CUTTING TOOLS.** Ice is harvested from the rivers and ponds in the northern United States and in Canada by gangs of men assisted by horses. For clearing the snow from the ice, they make use of the snow-planer, or ice-plane, as it also is called. This is usually a one-horse scraper which looks much like a boy's hand-sled, on which a man rides to give it weight in clearing off the snow. When a field is cleared, the ice-marker is brought into use to lay out the cutting. Parallel lines are marked out, about twenty inches apart, the implement used being a sort of plow with several short shares, which scratch the ice. This plow is drawn by a horse, and, the first line being laid out straight and accurately, the rest is easy, as the marker has a guide which runs in the groove of the first scratch, keeping the lines parallel. The ice-cutter is another one-horse implement, with shares that cut deeper than those of the marker, and it finishes the cut, several trips being required if the ice is thick. The cross-cuts, which sever the ice into blocks, are usually made by hand, with a long saw having a cross-bar for a handle. Striking-off bars and chisel-bars are used to loosen the blocks when insufficiently sawed or cut. As the blocks of ice are loosened, they are seized with a combined hook and pick, mounted on the end of a long handle, and directed toward the icehouse. Various tongs, hatchets, spades, etc., also, are used in handling the ice. The work is usually begun at the foot of an elevator leading to the ice-house, and as the ice is taken away the channel left in the water is used to float the blocks up to the elevator. This elevator is usually a conveyer, set at an angle of perhaps thirty degrees, and having slats mounted on an endless chain. These slats carry the blocks of ice up the incline to the icehouse. Elevators have also been built on the principle of an upright spiral, whose rotating flanges carry up the ice, but the conveyer form is the most common.

C. H. COCHRANE.

**ICELANDIC LANGUAGE AND LITERATURE.** See ICELAND, Vol. XII, pp. 621-628.

**ICELAND SPAR.** See CALC-SPAR, Vol. IV, p. 653; and LIGHT, Vol. XIV, p. 609.

**ICE-MACHINE.** Various types of ice-machines have been manufactured, but the only practical successes have been those employing the expansion of a compressed gas, or of a liquefied vapor cooled during compression. The gaseous ammonia frigorific machines are used most widely, being so called because they employ anhydrous ammonia. In principle, such machines consist of an evaporator or congealer, in which the vapori-

zation of the ammonia takes place; a pump for aspirating the gas as formed in the evaporator; a liquefier or condenser, where the gas is compressed by the pump, the liquefaction being aided by a condensing stream of cold water. This last-named portion of the apparatus serves simply to restore the ammonia to its original state, that it may be used over and over again. In order to utilize the low temperature obtained by this apparatus for making ice, the usual practice is to run the ammonia into coils for evaporation. These coils being led into tanks of brine, the evaporation robs the brine of its heat, and cans of water, being set into the brine-tanks, are frozen. The usual sizes of can-molds are for containing one hundred to three hundred pounds of ice, but within a few years the manufacture of plate-ice has come to be preferred in many quarters to can-ice. These plates of ice are about eight by sixteen feet in size and twelve to sixteen inches thick. From eight to twelve days' time is required to freeze them.

The most recent ice-machines, built on the principles described, will produce about thirty-two pounds of ice per pound of coal consumed, the proportion depending somewhat on the outside temperature at the time.

C. H. COCHRANE.

**ICE-PLANT,** a name given to *Mesembryanthemum crystallinum*, a genus of the family *Aizoaceae*. It is a native of South Africa, frequent in cultivation, and is remarkable for the glistening little excrescences which cover the foliage, like frost. It is prostrate, with broad leaves, and sessile white or purplish flowers.

**ICHTHYOL,** a dark-brown liquid obtained by the distillation of a bitumen found in the Tyrol. It has a tarry smell and taste. As it contains 15 per cent of easily assimilated sulphur, it is used as a medicament, both internally and externally.

**ICHTHYOPSIDA.** See REPTILES, Vol. XX, pp. 437, 438.

**ICHTHYORNES,** a genus of toothed birds (*Odontornithes*), whose remains were found in the Cretaceous strata of Kansas. The name, signifying fish-bird, refers chiefly to the vertebræ, which are biconcave, like those of fishes. The teeth were set in sockets. This bird was little larger than a pigeon.

**ICHTHYOSIS.** See SKIN DISEASES, Vol. XXII, p. 121.

**ICO,** a town in the state of Ceará, Brazil. It ships cattle, grain, cotton, etc. Its trade is mostly with Aracaty, and the population is about 7,000.

**ICONOCLAST,** an image-breaker; especially one of the party in the Eastern Church which rejected the worship of images and pictures. See IMAGE-WORSHIP, Vol. XII, pp. 712, 713.

**ICTINUS,** a Grecian architect; a contemporary of Pericles. In connection with Callicrates, he built the Parthenon in the Acropolis at Athens, the temple of Apollo Epicurius in Arcadia, and the temple in which the Eleusinian mysteries were performed.

ID. See HEREDITY and IDE, in these Supplements.

IDA, MOUNT. See TROAD, Vol. XXIII, p. 578; and CRETE, Vol. VI, p. 569.

IDA GROVE, a town and the capital of Ida County, Iowa, in an agricultural and stock-raising district, and on the Chicago and North-Western railroad, and the Maple river, 48 miles E. S. E. of Sioux City; has factories of corn-planters, flour, and machinery. Pop. 1900, 1,967.

IDAHO, one of the extreme Northwestern states of the Union, extends from the Dominion of Canada on the north to Nevada and Utah on the south, a distance of 441 miles, and from Montana and Wyoming on the east to Oregon and Washington on the west, the width varying from 44 to 306 miles, the average being about 250 miles. The area is 84,290 square miles, or 54,272,000 acres. The population in 1890 was 84,385; that of 1880, 32,610, the gain being 51,775, or more than 158 per cent. The increase during the preceding ten years was in excess of 117 per cent, the population in 1870 being only 14,999. In 1890 the number of whites was 82,018; negroes, 201; Chinese, 2,007; civilized Indians, 159. The population by the Twelfth (1900) Census was 161,771.

Idaho was created a territory by act of Congress, March 3, 1863. A constitutional convention assembled at Boise City, and, July 4, 1889, drafted a constitution, which was ratified by the people and submitted to Congress, July 3, 1890. The territory was proclaimed a state, being the forty-fourth in order of admission to the Union, and the thirty-first under the Federal constitution. The constitution adopted provided that the senate should consist of 18, and the house of 36, members, and should never exceed 24 and 60 respectively. The executive department consists of a governor, lieutenant-governor, secretary of state, auditor, treasurer, attorney-general and superintendent of public instruction, each to hold office two years. The governor has the right to veto separate items of any appropriation bill. The supreme court consists of three judges, to be elected at large. Women residents six months in the state may hold school offices and vote at school elections. Almost the entire vote of the territory was registered on the question of statehood, and out of a total of 14,184 votes, 12,398 were cast in favor of and 1,773 against it.



STATE SEAL OF IDAHO.

Idaho is an Indian word meaning "Gem of the Mountains." The first white man to enter the territory now comprising the state was Captain

Clark, with a detachment of the Lewis and Clark exploring expedition, about Aug. 12, 1805. In 1810 a trading-post was established on Snake River, but soon was abandoned. In 1834 Fort Hall was established as a trading-post on the Fort Hall Indian reservation, near Snake River. In 1860 gold was discovered on Oro Fino Creek, a tributary of the Clearwater, followed by other valuable finds in rapid succession. The first permanent settlement was made at Mount Idaho, the present county seat of Idaho County, in May, 1861.

Idaho is in the same latitude as France, Switzerland and portions of Italy, Spain and Portugal. The average or mean temperature at Lewiston, in northern Idaho, is 56°, a milder showing by 5° than is made by Ohio, milder by 10° than Iowa, and milder by 12° than Maine and New Hampshire. Boise City, in western central Idaho, has a much greater altitude than Lewiston, and has an average temperature of 51°, the same as Ohio, and 4° warmer than Connecticut.

The forest area of the state is estimated at 7,000,000 acres, the greatest timber regions being in the extreme north. Bull-pine, white pine, tamarack and fir predominate here, while cedar attains great height and thickness. There are, in other sections of the state, various varieties of fir, white, red and black spruce, yellow and white pine, mountain mahogany, juniper, birch, cottonwood, alder and willow. Idaho is a vast lumber-preserve for future generations.

The soil of Idaho is well adapted to agriculture, but in almost all sections of the state irrigation is necessary, on account of the limited rainfall, though in the extreme north there is sufficient rain to insure good crops, as is also the case in the mountain valleys of the southern and central sections. Estimates as to the amount of agricultural lands within the state vary from 13,000,000 to 16,000,000. The elevation of the land governs, to a great extent, the character of its productions. The valleys of Bear Lake, Lemhi and Custer counties are cultivated profitably at an elevation of 6,000 feet above tide-water; and at 5,000 feet, oats, wheat, potatoes, turnips, etc., are raised abundantly. Timothy and a few hardy grasses flourish at these altitudes. At 4,000 to 4,500 feet all kinds of grain and vegetables are profitable, except a few tender garden products. In some localities fruit is grown successfully at 4,000 to 4,300 feet, and berries are abundant at 4,500. The Boise valley, so prolific of all kinds of fruit, is 2,800 feet above the ocean, while the valleys of the Clearwater and Snake rivers, near Lewiston, in the northwest, with an altitude of but 680 feet, revel in tropical vegetation. Thus Idaho, in addition to its invaluable mineral wealth, possesses a share of the best climatic influences of every portion of the Union. The soil in the valleys and on the plateaus in the eastern and southern parts of the state is composed of vegetable matter mixed with mineral, and in some localities, with sand and clay. On this class of soil sage-brush

grows extensively. In the northwestern counties, dark loam of great depth prevails. In the gulches and near the mountains the soil is mixed with decayed rock. Alkali soil is limited to narrow strips, in widely separated localities, and rarely interferes with agriculture. The yield of all kinds of cereals, when the land is irrigated, is most gratifying, and is not surpassed by any state or territory. The same can be said of all kinds of vegetables, while in many parts of the state tender vines produce abundantly. Fruits are excellent in quality and flavor. Apples, plums, pears, peaches, prunes, apricots, grapes and all small fruits and berries are raised in great abundance. Huckleberries, gooseberries and cherries grow wild, in profusion, on the mountain sides and foothills. Among the mountain ranges are many valleys, large and small, affording, in the aggregate, a vast area of agricultural lands not exceeded in fertility by any in the world. The arable portions of the valleys lie from 600 to 6,000 feet above the sea, and they range in size from one to twenty miles in width, and from twenty to one hundred miles in length.

Mining is the principal industry of the state. The total metal-production for 1897 was \$13,110,000, of which \$2,500,000 was gold, \$7,100,000 was silver, \$3,500,000 was lead. Both gold and silver are found along the rivers and in every county in the state. The census of 1890 shows Idaho third among the states of the Union in the production of lead. At different points in the state are deposits of coal and iron, and in the southeast is found sulphur, soda, magnesia, carbonates, sulphate of lime, almost pure salt, and other minerals and alkalis.

Notwithstanding the great amount of arable land and the fertility of the soil, agriculture is not carried on to any great extent, though the showing made by the state at the World's Fair, of the products of the state, was very creditable, including wheat, corn, oats, rye, clover, flax, hemp, cotton, tobacco, figs, almonds, walnuts, apples, quinces, peaches, pears, plums, cherries, apricots, nectarines, prunes, berries, and many varieties of the finest grapes. The total production of the cereals—corn, wheat, oats and barley—together with potatoes and hay, for the year 1893, amounted to almost \$5,000,000.

The total assessed value of all property on Jan 1, 1899, was \$30,423,671. On Jan 1, 1898, the net debt was \$597,469. For 1898 the ordinary revenue was \$359,496; and the ordinary expenditure \$223,882. In 1897 the bullion receipts at the U. S. assay office at Boise were \$1,497,146.

The wool-clip for 1897 amounted to 9,189,719 pounds, coming from 1,312,817 sheep, which was valued at about \$3,500,000.

Large appropriations have been made for the purpose of constructing irrigation canals and ditches, the Snake River and its tributaries furnishing an abundant water-supply. Up to 1894 about \$2,000,000 had been expended for the purposes of encouraging irrigation. The fertile bottom-lands of the Snake River and of some of the

other streams yield the most abundant crops when under irrigation.

The state has had grants from the general government of over 4,000,000 acres of land, much of which has been apportioned to specific institutions and a large revenue thereby obtained. Of the 90,000 acres granted to the Agricultural College, 75,703 acres have been selected; of the 150,000 acres granted to charitable and other institutions, 96,617 acres have been selected; of the 50,000 acres granted to the insane asylum, 42,670 acres have been selected; and out of the grant of 100,000 acres granted to normal schools, 46,824 acres have been selected.

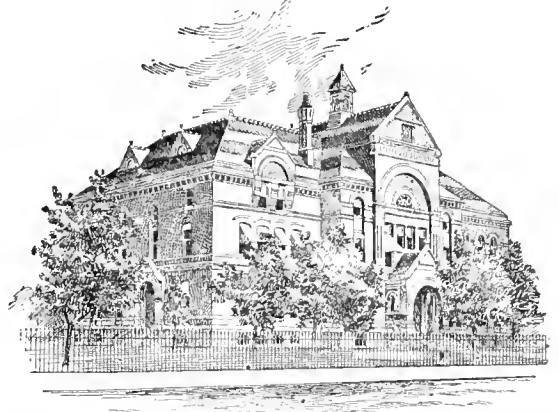

STATE CAPITOL, BOISE CITY.

The school census of 1898 gives the number of children within the school age as 38,810, the amount of the school fund for the same year being forty thousand dollars. The school system has been improved very materially within recent years; the Mormons, formerly opposed to the public schools, now give them their hearty support, and Mormon children attend the district schools throughout the entire state. Higher education is provided abundantly, the University of the State of Idaho being the principal institution. It is located at the city of Moscow, and, in addition to state support, receives the government appropriation to which agricultural colleges are entitled. Three experiment stations are attached to the university, one located at Nampa, one at Grangeville and one at Idaho Falls. State normal schools are established at Albion and Lewiston, bonds having been issued for their support and maintenance.

The state institutions comprise the insane asylum and the penitentiary, for each of which an appropriation of sixty-five thousand dollars was made in 1895. The former is located at Blackfoot, Bingham County, and in 1898 had 187 patients, with a total expenditure of \$37,731. The rate of insanity among the people of Idaho is less than one-half that of the average rate of the other states of the Union. The penitentiary is located two miles east of Boise City. On July 1, 1897, the inmates numbered 210, which is about the average number confined. The deaf, dumb, and blind are cared for at the Colorado Springs (Colorado)

Deaf, Dumb and Blind Asylum, an annual charge of \$250 for each person being made, which is paid by legislative appropriation. It was estimated that at the close of 1895 not more than fifty persons in the entire state were entitled to the provisions of the act, while not more than ten at any one time have availed themselves of its provisions. In 1895, twenty-eight thousand dollars was appropriated for the support of the Soldiers' Home, which institution, at that time, contained 27 inmates and 11 officers and employees.

The state constitution makes no provision for state or savings banks, and the banks of the state are all national institutions. In 1895 there were 12 national banks, carrying in excess of three million dollars of individual deposits and having a capital of \$750,000.

At the beginning of 1899 there were 80 newspapers published in Idaho. Papers are published in all of the 21 counties and in 49 cities, towns, and villages. Of the total number of papers published, 5 are daily, 4 semiweekly, 66 weekly, 1 semimonthly, and 4 monthly.

The state is well supplied with railroads, the Northern Pacific and the Great Northern lines extending across the northern part, and the Union Pacific across the southern. The total number of miles of track in 1898 was 1,085.

According to the census of 1890 there were 184 church organizations in the state, with about the same number of churches and halls. The membership approximated 22,000, and the value of the church property was nearly \$300,000.

The census of 1900 showed the population of the principal towns in Idaho as follows: Boise City, 5,957; Montpelier, 1,444; Weiser, 1,364; Paris, 906; Genesee, 731; Wallace, 2,265; Lewiston, 2,425; Caldwell, 997; Grangeville, 1,132; Pocatello, 4,056; Malade, 1,050; Rexburg, 1,081.

The following is a list of the governors of Idaho, with their terms of office: Territorial—William H. Wallace, 1863-64; Caleb Lyon, 1864-66; David W. Ballard, 1866-67; Isaac L. Gibbs, 1867-68; David W. Ballard, 1868-70; Gilman Marston, 1870-71; Thomas W. Bennett, 1871-75; Mason Brayman, 1877-78; John P. Hoyt, 1879; Mason Brayman, 1880; John P. Neil, 1880-83; John N. Irwin, 1883; William N. Bunn, 1884-85; Edward A. Stevenson, 1885-89; George L. Shoup, 1889-90. State—G. L. Shoup, 1890; N. B. Willey, 1891-92; W. J. McConnell, 1893-97; F. Steunenberg, 1897. See also IDAHO, Vol. XII, pp. 697, 698.

IDAHO SPRINGS, a post town of Clear Creek County, northern central Colorado, on the Union Pacific railroad, at the junction of Chicago and Clear creeks, 34 miles W. of Denver. It is surrounded by beautiful scenery, and is well known for its hot and cold mineral springs, which attract a large number of visitors in summer. The springs contain, as principal ingredients, carbonates and sulphates of soda and magnesia. There are swimming and vapor baths here. Gold, silver, copper and lead are mined in the vicinity. Population 1890, 1,338; 1900, 2,502.

IDANTS. See HEREDITY, in these Supplements.

IDAS, in Greek mythology, one of the Apharetidæ, or sons of Aphareus and Arene; the husband of Marpessa, whom he took away on a winged chariot from Apollo, another of her suitors; the brother of Lynceus and the father of Cleopatra and Aleyone. He and his brother had a pitched battle with the Diocuri, Castor and Pollux, the sons of Jupiter, caused by an unfair division of cattle stolen by the four warriors. It is said to have taken place in Mecene or Laconia, and to have ended by the death of both Apharetidæ, the twin sons of Jupiter being saved from destruction by a bolt of lightning striking Idas.

IDDA OR IDDAH. See NIGER, Vol. XVII, p. 497.

IDDESLEIGH, LORD, better known as Sir Stafford Northcote, an English statesman; born in London, Oct. 27, 1818, and educated at Eton and Balliol College, Oxford, graduating with distinction in 1839. In 1843 he became private secretary to Mr. Gladstone, then president of the Board of Trade. He was called to the bar at the Middle Temple in 1847. In 1851 he succeeded to the baronetcy of his father, and in this year was made secretary to the commissioners of the Universal Exhibition, and was knighted for his services in connection therewith. In 1855 he entered Parliament, as a Conservative, for Dudley, and sat for various constituencies until his elevation to the peerage. In 1889 he was appointed Financial Secretary in Lord Derby's Cabinet, and in 1866 was appointed by the same minister president of the Board of Trade. In 1868, while Secretary for India, he had charge of the Abyssinian expedition, which was conducted with success. In 1871 Mr. Gladstone appointed him British commissioner to the United States to aid in the adjustment of the *Alabama* claims. In 1874 he was Chancellor of the Exchequer in the Cabinet of Mr. Disraeli, and on the latter going to the Upper House, Sir Stafford became leader of the House of Commons. In 1885, on the accession of Lord Salisbury to power, the latter bestowed a peerage on Sir Stafford, who went to the Upper House as the Earl of Iddesleigh and Viscount St. Crys and was also appointed First Lord of the Treasury. He was Foreign Secretary in Lord Salisbury's second administration. He resigned early in January, 1887, and on the 12th of the same month he died very suddenly at the official residence of the Premier, in Downing Street. In 1883 he was elected, by the students, lord rector of the University of Edinburgh. He was noted for his literary taste, and his works are *Twenty Years of Financial Policy, 1842-61* (1862); *The Pleasures, the Dangers and the Uses of Desultory Reading* (1885); and *Lectures and Essays* (1887).

IDE OR ID, a small fresh-water cyprinoid fish, *Leuciscus idus* or *Idus melanotus* of Europe, closely allied to the American *Cyprinidæ*. Its flesh is esteemed. A domesticated variety, colored like the goldfish, is known in northern Europe as the orfe.

IDEALISM, a term which, besides its ordinary sense of seeking to expound or realize an ideal condition or standard, is applied to a method in art and a school of philosophy.

Art. There can be no art without the expression

of that personal quality of the artist which is the root of idealism. Representations which are without a human element of choice, taste or feeling are mechanical, and not artistic, productions. Even the extreme realist cannot escape registering something of his personality in his work; for the painter cannot put on his canvas all the details that actually confront him. He must distinctly recognize something that appeals to his sentiment, and then produce what *his* eyes see, and it is in reproducing his own moods and visions that the art lies. Yet there is a wide range from Meissonier, with his Dutch fidelity to details, and Cimabue and the Byzantine painters. The antipodes are a Sistine Madonna and a Bacchanalian scene by Ccuture. There is no complete antithesis between idealism and realism in art; it is a question, simply, of the predominance of the artist's individual moods and exaltations over his fidelity in depicting the object to be represented as it is in itself and must seem to others. For a discussion of this subject from a philosophical point of view, see *ÆSTHETICS*, Vol. I, p. 213; and for a critical consideration of it, see *FINE ARTS*, Vol. IX, pp. 210, 211.

*Philosophy.* Idealism is a scheme of philosophy that finds the ground and reality of things in thought. In its largest sense, it is one, and the elder and more Protean one, of the two possible methods of philosophy. In calling it the elder, the Greek physicists are neglected, because of their inability, Democritus perhaps excepted, to find the fruitful germ of a persistent development. Philosophy sets for itself the task of bringing all the individual particulars of a complex universe into a unity that relates these particulars to each other. Yet this eternal problem is worked under the limitation that all the material of philosophy is that small portion of nature which has become a part of human experience and the object of conscious reflection. The naturalist or experimentalist begins from without, and endeavors, by gathering the data of observation to produce a system, the unity of which is found in force, or will, or pure being. Empiricism begins with experience and works upward. The idealist reverses the process, and, starting with pure being, or the absolute, works downward to the explanation of the phenomenal. Both methods have the same goal to reach—the one ground of being. In history, idealism has been the chief support of religious systems, and experimentalism of skepticism, hence the passion of philosophy.

The first step in philosophy is taken when a man reflects upon his own identity, or becomes conscious of self. By this, something more is meant than that vague sense of a continuous memory which the savage, and probably beasts, have in common with the thinker. It is self as perceived, self as object, self as the principle that brings all the facts of consciousness into relation.

All mental perceptions are mere unrelated and distinct entities, passing in meaningless sequence, through consciousness, until they are seen to be united by a persisting principle, which is the perceiving *ego*. But why should this principle of personal identity bring perceptions into relation? Because of thought and the laws of thought. Now, thought does not deal with objects, but only with

the ideas or presentations of objects in the mind. Ideas are the subject-matter of thought; or, rather, a perception of their relations is thinking. What, then, are the real things of knowledge? Psychologically, they are ideas, or thought, and the treatment of them as such constitutes idealism. Hence the force of the injunction of Thales in its Socratic and even in its Buddhistic sense, "Know thyself."

As the individual *ego* finds in thought the grounds of its own knowledge, and systematic grasp upon it, and is able to contemplate itself as an object of reflection and even of investigation, so it comes to conceive of being outside of itself, which is the substance of unity for all other individual life, giving certitude and correspondence to the knowledge of all men. Thus the supreme principle is reached, absolute being, the ground and essence of all other being. Primordial being is the "pleroma" of all individual beings—the principle giving validity to all thought.

Because the idea of identity, or the consciousness of self, works this unity in the perceptions of consciousness, so it teaches men to apply the same method of thought to nature or all external verities. They are the phenomena of thought, the embodiment of the idea. The same rational principle that exists in the human mind is conceived to give unity to the particular entities of external nature. To use a metaphor of Goethe, "The roaring loom of time weaves the vesture God puts on."

Out of the postulates now broadly stated have grown innumerable schools of philosophy, of which some historical notice will be found under *EVOLUTION*, Vol. VIII, pp. 751-772. If God be viewed quite anthropomorphically, a doctrine of creation will be developed. As the human attribute of personality is withdrawn from Him, theories of emanation ensue, and no people have carried them further than the Hindus. The complete denial of personality to the absolute results in pantheism. Pantheism, in turn, has manifold forms. We may have from it a refusal to recognize the objective world at all; or that world may be reduced to mere phenomena without material substance; or object and subject may be identified as opposite poles of one thing; or sentient nature may be regarded as the agency by which primordial being becomes self-conscious. From a religious point of view, idealism, when held in a rigid dialectic, gives rise to dogmatism; when intuitional, to mysticism. The idealistic school, therefore, separates into two great divisions the theistic, or spiritualistic, and the pantheistic. Opposed to it was the nominalism of the schoolmen, which held that real existence was predicable only of individual things, and that the ideas represented by class names were only convenient generalizations. This school had for its logical sequence the doctrine of the sensationists, that ideas are reproduced sensations. The Scotch school assumes the reality of the natural world, relying on the validity of the mental affirmation that our perceptions represent the things that caused them. The experimental philosopher also holds a realism, affirming that cognitions of external things correspond to exterior and real phenomena, and

furnish real and assured knowledge. Another name for this doctrine is "perceptionalism," and it is the ground taken by physical scientists. This form of realism must not be confounded with that of the mediæval schoolmen, for whom universal terms, type concepts and class words stood for persisting actualities, independently of sensible phenomena, although the phenomenal must conform to and embody the universal or type idea. Their doctrine admitted the Platonic theory of all nature existing forever in the divine omniscience, in the form of ideas or thought, and taught that these archetypal ideas are the essence of phenomena, while perceptions of phenomena furnish the material of knowledge. Thus the idea exists *ante rem*, *in re* and *post rem*.

Idealism emerges into the history of philosophy with the Eleatic school, of which Parmenides was the chief expounder. With him, pure primordial being, uncreated, indivisible, imperishable, changeless, is the sole object of thought, and all else is illusory and phantasmal. With Anaxagoras this illimitable being is Mind or Reason, and the origin of all form and life. But it was Plato who gave persistent development to idealism, with his doctrine that all the forms of the universe lay as ideas or thought in the omniscient Mind, where they were immaterial and eternal essences, and that the finite universe was the result of a movement to realize these archetypes in phenomena. Aristotle is not clear upon the subject, but, while rejecting Plato's archetypal ideas, declares that "universals and the truths apprehensible by the highest reason are 'by nature more known' than individual concrete phenomena and the facts apprehended by sense." This idealism of Greek philosophy became the possession of the Neo-Platonists of Alexandria, and subsequently it passed into Europe through the Arabian commentators of Aristotle. Its influence on scholasticism has already been pointed out.

It belongs to Descartes to have called attention away from the multiform essences and quidities of the schoolmen, in the consideration of which they seem to have forgotten philosophic unity and to have left small place for natural science. He addressed himself to the work of finding the ground of all knowledge, whether of ourselves or of external nature, and for the latter he finds support in mathematical conceptions of extension and motion. Yet he was an idealist; for he finds the unity and cohesion of things in thought. "The formal fact of thinking is what constitutes our being; but this thought of which we are certain leads us back, when we consider its concrete contents, to the necessary presupposition on which our ideas depend, the ultimate totality in which they are all reconciled, the permanent cause on which they and we, as conscious beings, depend"—an infinite, perfect and omnipotent intelligence, or pure Mind. Thus he opened the way for Locke, Berkeley, Hume, Kant, and the whole succession of German metaphysicians to Hartmann.

Locke tried, by an inductive method, or a critical scrutiny of the facts of consciousness, to determine how far the operations of the human mind were

valid sources of knowledge. Yet the facts that he dealt with were mental concepts and percepts; for he says, concerning physical sciences, "our knowledge is very short, if indeed we have any at all." Even while objecting to "innate ideas," it was chiefly an objection to treating them as beyond investigation; for he confessed there were ideas, as of substance or cause, not presentable to the mind, but which he could not do without.

Although George Berkeley has been accounted the apostle of "subjective idealism," because he held, as a metaphysician, that matter and external things are inconceivable as existences outside of the circle of consciousness, yet he taught a fundamental distinction between the ideas that arise from sense-experience and those that come from the activity of the mind acting on itself. Sense-experience is the realization, in the finite mind, of the archetypal ideas of the divine mind. In God, who is free, and not fate, and who is not the human *ego*, the external world becomes objective to the thinker. Because of our belief that the universe is caused and regulated by intelligence, we are assured that there must be a correspondence in nature between phenomena and our sense-perceptions.

Hume was not less an idealist than Berkeley, but he was the chief of modern skeptical philosophers, because to him ideas were discrete entities. He says: "There are two principles which I cannot render consistent, nor is it in my power to renounce either of them; viz., that all our distinct perceptions are distinct existences, and that the mind never perceives any real connection among distinct existences." He could not find a metaphysical ground of unit satisfactory to his dialectic, and perceived that his philosophy was "a rope of sand."

At this point systematic metaphysics passed to the Germans. Kant, who was of Scotch ancestry, and familiar with Hume's writings, set to himself the task of finding a way out of the subjectivity of Locke and Hume. It is the fault of Hume's position that he did not see that his thinking at all involved his self, and in his identity or being lay the solvent of his problem. Kant's solvent lay in certain "necessary conceptions, of the reason for which no corresponding real objects can be given in the sphere of the senses." These ideas, although suggested by and necessary to experience, transcend experience; hence the phrase "transcendental idealism" applied to his philosophy. The views of the various German metaphysicians will be found best described under their own names in this *ENCYCLOPÆDIA*. It may here be noted, that their systems are various, characterized with none too great accuracy, but with epithets intended to indicate the leading principle of their teaching. Thus Spinoza, for whom the divine mind dominated, and was the essence of all being, is called a substantial idealist; Fichte, who found in the primordial being the object of all thought, the source of all cosmic things, is termed a subjective idealist; Schelling, who affirmed the identity of subject and object as poles of one reality, receives the name of objective idealist; Hegel, who reduced the universe to phenomena, having substance only in the eternal thought, is the



absolute idealist. Schopenhauer found the root of all things in a principle he called will, or the self-determination of things to exist, and Hartmann lodged the origin and essence of things in unconscious being striving to come to self-consciousness in nature. Sir William Hamilton offered the phrase "cosmothetic idealism" to cover the doctrine that the external universe has actuality, but cannot be immediately known, or virtually the doctrine of the common-sense, or Scotch, philosophers.

D. O. KELLOGG.

IDEALISM IN FINE ARTS. See FINE ARTS, Vol. IX, pp. 209, 210.

IDEAS, mental conceptions made objects of knowledge or reflection. In philosophy, ideas are the subject-matter of metaphysical reasoning. See METAPHYSIC, Vol. XVI, pp. 79-102.

IDEATION. See PSYCHOLOGY, Vol. XX, pp. 57-60.

IDELER, CHRISTIAN LUDWIG, a German astronomer and chronologist; born near Perleberg, in Prussia, Sept. 21, 1766. After holding various offices, he was appointed professor of astronomy and chronology at the Berlin University in 1821. He wrote *Historische Untersuchungen über die Astronomischen Beobachtungen der Alten* (1806); *Handbuch der Mathematischen und Technischen Chronologie* (1825-26); and *Handbuch der Französischen Sprache und Litteratur* (1852). He died Aug. 10, 1846.

IDENTITY OR PERSONALITY. See *Self*, under PSYCHOLOGY, Vol. XX, pp. 83-85.

IDES. See CALENDAR, Vol. IV, p. 665.

IDIOCY. See INSANITY, Vol. XIII, pp. 95-113.

IDIOPLASM. See EMBRYOLOGY and HEREDITY, in these Supplements.

IDOCRASE. See MINERALOGY, Vol. XVI, p. 410.

IDOMENCUS, in Greek mythology and Homeric legend, a king of Crete, son of Deucalion, who took part in the Trojan war, with ninety ships, on the Greek side, and was famous for his valor. On his return, and during a dangerous storm, he rashly vowed to give to Neptune, in case he were saved from drowning, the first object he should see on reaching the Cretan shore. This was his son, whom he mercilessly sacrificed to fulfill his vow. Having thus become odious to his subjects, he soon was exiled from his own kingdom. Having landed on the Italian coast, he founded the city of Salentium, in Calabria, where he spent the rest of his life.

IDUN OR IDUNA, the name of a goddess of Norse mythology. See ÆSIR, Vol. I, p. 211.

IESI OR JESI. See JESI, Vol. XIII, p. 644.

IGLESIAS, MIGUEL, a Peruvian soldier and statesman; born in Cajamarca, Peru, Aug. 18, 1822. Wealthy by inheritance, he received a careful education and studied law; was several times elected a Deputy, 1861-76; he became Senator in 1879; was appointed Minister of War by Dictator Pierola in December, 1879; he defended Lima valiantly, but unsuccessfully, against the Chileans. After the complete defeat of the Peruvians, he was placed at the head of the peace party that overthrew Pierola; having assumed the Presidency, he signed the treaty

of peace with Chile, Oct. 20, 1883. The Chambers ratified the treaty, although it gave up everything to the conquerors. Caceres raised the standard of revolt, and, having captured Lima, Dec. 1, 1885, after a long period of alternate successes and defeats, forced Iglesias to resign pending a Presidential election. It was held in June, 1886, and resulted in favor of Caceres; his rival left the country and settled in Europe.

IGNATIEFF, NICHOLAS PAVLOVITCH, a Russian soldier and diplomatist; born in St. Petersburg, Jan. 29, 1832; a godson of Emperor Alexander II. He was the son of Count Paul Ignatieff, a captain of infantry who, at the time of the military insurrection that occurred at St. Petersburg in consequence of the accession of the Grand Duke Nicholas to the throne of Russia in 1825, was the first to pass over, with his company, to the side of the new czar, thus insuring the triumph of the former and gaining for Captain Ignatieff and his family the powerful protection of Nicholas I. His son was educated at home and in the Corps des Pages; entered the Chevaliers-Gardes (1849), and after three years' study appointed staff-officer (1852). At the beginning of the Crimean War he was placed on the staff of General Berg; was appointed quartermaster-general of the Baltic Corps at Riga; and left the military for the diplomatic service, first as military attaché to the embassy at London. One of his reports on England's military position in India so pleased the Emperor that he summoned Captain Ignatieff to Warsaw for a personal interview. Appointed colonel and aide-de-camp to the Emperor in 1858, he was sent on a special mission to Kliwa and Bokhara. Created a major-general in the imperial suite in 1860, he was sent as plenipotentiary to Peking, where he concluded a treaty by which the province of Ussuri was ceded by China to Russia. On his return to Russia, he was made director of the Asiatic department in the Ministry of Foreign Affairs. Appointed minister at Constantinople in 1864, his legation was raised to the rank of an embassy in 1867. The object which General Ignatieff steadily pursued at Constantinople was to secure for Russia a powerful influence over Turkey. He completely reassured the late Sultan Abdul Aziz as to the intentions of the government of St. Petersburg, while, on the other hand, he gained the good will of the Christian subjects of the Porte by his kindly behavior and his anxiety to protect them. He was recalled from the embassy at Constantinople, May 2, 1878, Prince Lobanoff being sent there in his place. Afterward he was appointed Minister of the Interior, from which post he was dismissed in June, 1882, on account of his Pan Slavist intrigues, and for shutting his eyes to the persecution of the Jews. He remained, however, a member of the Council of the Empire.

IGNATIUS, FATHER. See LYNE, in these Supplements.

IGNATIUS, SAINT. See APOSTOLIC FATHERS, Vol. II, pp. 196, 197.

IGNATIUS BEAN, a name given to the seed of *Strychnos Ignatii*, of the family *Loganiaceæ*. The fruit is a spherical berry, containing compressed

bean-like seeds. It is an article of commerce, yielding the well-known alkaloid strychnia.

IGNIS FATUUS. See PHOSPHORESCENCE, Vol. XVIII, p. 813

IGNORANTIA FACTI, the want of knowledge as to some fact in question. It is a general rule of law that when a contract is entered into through ignorance of some material fact on the part of one of the parties thereto, such party may avoid the contract. The same rule will generally apply when money is paid under a mistake of fact, and the money so paid may be recovered. The contrary is generally true when the mistake was one of law. See IGNORANTIA JURIS, in these Supplements.

IGNORANTIA JURIS, the want of knowledge of the law. It is a legal maxim that ignorance of the law excuses no man. This maxim is founded upon public policy, and the law presumes every one to know the law. It is, therefore, the rule that an act done or contract entered into through ignorance of one's legal rights will be enforced. Through the great injustice which may at times result from the absolute enforcement of this rule, exceptions have frequently been allowed, where the mistake is clearly made out and manifest injustice will be done by strictly enforcing the rule. Where the mistake is mutual to both parties to a contract, the general rule is that it may be set aside. The rule, however, that money voluntarily paid under a mistake of legal rights cannot be recovered is practically absolute.

IGOR, TALE OF THE TROOP OF THE. See RUSSIA, Vol. XXI, pp. 87, 104.

IHLANG-IHLANG, the Malayian name of the perfume of *Unona odoratissima*, a forest tree of the Malay Islands. This rich perfume is much used in making various fine perfumes of commerce.

IHRE, JOHAN. See *Literature*, under SWEDEN, Vol. XXII, p. 756.

ILBERT, SIR CHARLES P., an English lawyer and politician; born at Kingsbridge, Devon, June 12, 1841; graduated at Balliol College, Oxford, where he was awarded several important scholarships and first class honors; elected a fellow of Balliol (1864); called to the bar (1867); practiced as a parliamentary and equity draftsman and conveyancer; counsel to the Education Department (1879-82); legal member of the Indian Viceregal Council (1882-86); acting governor-general (1886); author of the Bengal Tenancy Bill, a measure which affected favorably the interests of sixty millions of the Empire's subjects; permanent assistant Parliamentary counsel of the Treasury (1886); knighted in 1895. He drafted the Ilbert Bill, conferring jurisdiction over Europeans on the native judiciary, which caused much indignation in India. It was withdrawn in deference to popular opinion.

ILEUM. See DIGESTIVE ORGANS, Vol. VII, p. 226.

ILEUS. See COLIC, Vol. VI, p. 140.

ILEX. See HOLLY, Vol. XII, p. 101.

IL GAROFALO. See TISIO, Vol. XXIII, p. 409.

ILI or KULJA. See KULDJA, Vol. XIV, p. 154.

ILIJATS. See PERSIA, Vol. XVIII, pp. 627, 628; and TURKS, Vol. XXIII, p. 661.

ILINIZA. See ECUADOR, Vol. VII, p. 645.

ILION, a thriving village of Herkimer County, central New York, on the New York Central and Hudson River and the West Shore railroads, the Erie canal, and on the Mohawk River. Firearms, typewriters, sewing-machines, wagons, carriages and agricultural implements are manufactured here. The Colt revolver and Remington typewriter factories are here. The village has an academy, public library, waterworks and electric lights. Population 1800, 4,057.

ILION or ILIUM. See TROAD, Vol. XXIII, 579.

ILISSUS. See ATTICA, Vol. III, p. 60.

ILLAMPU or SORATA. See PERU, Vol. XVIII, p. 672.

IL LASCA. See GRAZZINI, Vol. XI, pp. 78-79.

ILLEGITIMACY. See BASTARD, Vol. III, 426-28.

ILLIMANI, a mountain. See PERU, Vol. XVIII, p. 672. The first ascent was made on Sept. 9, 1898, by Sir Martin Conway, who calculated the height to be from 22,200 to 22,500 feet.

ILLINOIS, called the "Prairie State," from the level character of its surface, has an area of 56,650

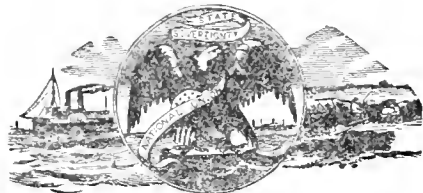

STATE SEAL OF ILLINOIS.

square miles, or 36,256,000 acres. In 1880 the population was 3,077,871 and the relative rank fourth. The population in 1890 was 3,826,351, giving it the rank of third in population among the states of the Union. The density of population was 68.33 to the square mile; the 24 cities of the state contained 1,485,955 inhabitants, constituting 38.83 per cent of the total population; the relative proportion of males to females was 1,972,308 of the former, 1,854,043 of the latter; the percentage of native-born citizens was 77.99, of foreign-born 22.01. The population of the state in 1900 (12th census) was 4,821,550, an increase over that of 1890 of 26 per cent.

The total amount of property in the state upon which taxes were levied for the year 1899 was \$778,474,910, of which almost \$80,000,000 was railroad property, and nearly \$208,000,000 consisted of property within Cook County (Chicago) alone. The total receipts from all sources for the year 1898 were \$15,181,030, and the disbursements were \$13,017,652. The tax rate for 1898 was 56 cents on the \$100 valuation, of which 13 cents belonged to the school fund, and the remainder to the general revenue fund. On Oct. 1, 1898, the total outstanding bonded debt was \$18,500, which draws no interest, the bonds having long since become due, but never having been presented for payment.

The state is eminently an agricultural region, the climate and soil being well adapted for the cultivation of the principal cereals. The reports of 1898 showed the following facts in relation to the leading crops: Corn, 7,051,500 acres, yielding 239,360,000 bushels, of the value of \$51,510,000; wheat, 1,911,-

852 acres, yielding 18,383,943 bushels, of the value of \$11,473,216; oats, 3,747,938 acres, yielding 108,720,511 bushels, of the value of \$21,218,742; rye, 115,822 acres, yielding 1,500,000 bushels, of the value of \$657,414; hay, 2,058,647 acres, yielding 2,840,933 tons, of the value of \$18,153,562; potatoes, 173,204 acres, yielding 16,800,788 bushels, of the value of \$4,368,205. In addition to these products, immense quantities of other crops were raised, such as barley, tobacco, buckwheat, sweet potatoes, and vegetables. The proximity to the great markets of Chicago makes small farming very profitable, and many thousands of acres within easy reach of that city are devoted to the raising of beans, cabbage, onions, melons, berries and other fruits and vegetables of many kinds. In 1890 in the acreage devoted to the cultivation of the cereals the standing of the state was that of first, the area being 14,191,410 acres, which constituted 10.12 per cent of the entire acreage of the United States. In the production of the cereals the rank was that of second, the total number of bushels being 468,643,860—13.32 per cent of the whole crop of the country. In corn the standing was first in acreage, and second in production. The first mentioned was 10.91 per cent of the entire amount of land under corn and the crop was 13.68 per cent of the total production. In wheat the state had the rank of seventh and third position in the matter of production. The rank of first was maintained in the area under oats, and second in production, the former being 13.67 per cent of the total acreage and the latter 17.01 per cent of the whole crop. In barley the position was eleventh in area and tenth in production; in rye, fifth in both area and production, and in buckwheat thirteenth in both the acreage and amount of the crop. Illinois had an average of 54.70 neat cattle to the square mile, giving it the rank of second in this connection. The total number and values of farm-animals in 1894 were as follows: Horses 1,308,771, value \$56,799,353; mules 104,720, value \$5,367,573; milch cows, 1,039,121, value \$26,102,720; cattle 1,553,383, value \$28,984,266; sheep 1,032,976, value \$2,450,632; swine 3,422,454, value \$23,988,664; the total number being 8,461,425 animals, of the value of \$143,693,208. The assessment of 1895 showed the number of acres of improved lands listed with the assessors amounted to 28,452,172, of the average value of \$10.82 per acre, a total valuation of \$307,863,735. There were 6,080,819 acres of unimproved lands, valued at \$4.04 per acre, or a total of \$24,545,750. The improved town and city lots assessed numbered 639,760, of an average value of \$376.74, a total of \$241,022,950. There were 837,454 unimproved lots, the average value of which was \$46.63, making the total \$39,051,394. The personal property in the state was assessed at \$129,254,545. The railroads of Illinois had an equalized assessment made against them on a basis of a valuation of \$81,565,298. The state board of equalization adjusted valuations and reported the total assessable value of all property subject to taxation at \$833,188,467. The shrinkage in value occasioned by the financial depression is best illustrated by the fact that notwithstanding the great increase in real value of

property in the state within the last two decades of the century the valuation of 1895 was more than \$500,000,000 less than that of 1873.

Coal has been mined in 56 of the 102 counties into which the state is divided, and the industry of coal-mining is one of the first importance. Statistics for 1894 show the total output for the year to have been 17,113,576 tons, and the average home value of the product \$15,282,111. The number of mines and openings was given as 836, and the number of employees 38,477, of whom 32,046 worked underground. St. Clair County stood first in production, with 1,623,684 tons; Macoupin stood second, with 1,575,045 tons, and Sangamon third, with 1,142,299 tons. Mining machinery is coming more rapidly into use than elsewhere, and in 1896 there were more than three hundred of these machines in operation.

By reason of the great amount of manufacturing carried on in the city of Chicago, Illinois stands very high in rank among the states in this industry. The census reports of 1890 give the total number of manufacturing establishments in the state as 20,482, the number in Chicago being 10,097. The total amount of capital invested is stated at \$502,004,512; the aggregate number of employees 312,198, whose wages were \$171,523,579, and the value of the products \$908,640,280. In the matter of capital invested, number of employees and the value of products, the ratio is about 66 per cent for Chicago and 34 per cent for the remainder of the state.

In 1897 the railroads of the state numbered 117 different lines, operating 10,775 miles of main track within Illinois. They had, in addition, 1,370 miles of second, third, and fourth tracks, and 3,806 miles of yard-tracks, sidings, and spurs, making the total mileage 15,951. The total railway capital represented by the lines in operation was \$2,725,415,138. The lines had outstanding stocks to the amount of \$978,563,848, and their bonds and other obligations amounted to \$1,189,418,515. The gross earnings from operation amounted to the sum of \$268,059,980, and the total net income from all sources was \$102,517,311. The total fixed charges were \$86,300,942, leaving the total net income \$16,216,369. Some of the lines had a deficit after the net income had been applied to the payment of the fixed charges, the total net deficit of all the lines operated at a loss being \$7,803,544. The total number of persons employed was 61,200, their pay amounting to \$46,848,608. The total number of passengers carried was 83,281,655, and total tons of freight 56,736,687.

In June, 1898, there were 139 state banks in Illinois, whose total capital stock amounted to \$17,148,000, their total resources \$159,956,854, and their total individual deposits subject to check \$51,216,941. The national banks number 212, with a combined capital of more than \$40,000,000, surplus and profits of almost \$24,000,000, and individual deposits in excess of \$126,000,000.

At the beginning of 1896 there were 726 building and loan associations doing business in the state. Their total receipts for the fiscal year were \$46,306,969; their assets were \$82,630,258, of which amount \$72,422,035 were loaned to stockholders.

The statistics relative to the National Guard for 1895 showed that body to consist of 5,567 officers and enlisted men, and the naval militia had a total of 359. The appropriation for the year was \$120,000, which is about the average annual expenditure for the maintenance of the Guard in ordinary times, but during the great strike of 1894 the cost to the state for the services and expenses of the Guard was but little less than a quarter of a million dollars.

The reports of the state superintendent of public instruction for the school year ending June 30, 1897, give the following facts: There were about 1,400,000 children within the school age of 6 to 21 years, of whom 920,425 were enrolled in the public schools. The average daily attendance was 705,481, the number of school districts was 11,612, the average school year 7.5 months. The report shows 138,542 children in private schools, attended by 4,615 teachers. The total cost of the public schools for the year was \$14,442,288, of which sum teachers received \$8,420,330. Of the denominational institutions of learning in Illinois, Hedding College, at Abingdon; Illinois Wesleyan University, at Bloomington; the Northwestern University, at Evanston; McKendree College, at Lebanon; Chaddock College, at Quincy, are all conducted under the auspices of the Methodist Episcopal Church. The Baptist Church controls the University of Chicago; Ewing College, at Ewing, and Shurtleff College, at Upper Alton. The Presbyterian Church manages Blackburn University, at Carlinville, and Lake Forest University, at Lake Forest. The Cumberland Presbyterian Church has Lincoln University, at Lincoln. The United Presbyterian Church controls Monmouth College, at Monmouth. The Lutheran Church manages Carthage College, at Carthage, and Augustana College, at Rock Island. Those under Roman Catholic control are St. Viator's College, at Bourbonnais; St. Ignatius College, at Chicago; St. Francis Solanus College, at Quincy, and St. Joseph's Diocesan College, at Pentopolis. The Evangelical Association has the Northwestern College, at Naperville. The United Brethren have Westfield College, at Westfield. The Congregationalists have Wheaton College, at Wheaton. The Universalists have Lombard University, at Galesburg; and the Christians have Eureka College, at Eureka. The non-sectarian institutions are the University of Illinois, at Champaign; Austin College, at Effingham; Northern Illinois College, at Fulton; Knox College, at Galesburg; Greer College, at Hoopston; and Illinois College, at Jacksonville.

Illinois has a great number of charitable, reformatory and penal institutions, costing immense sums for original construction, and entailing large annual appropriations for their maintenance. The Illinois Institution for the Education of the Blind cost \$200,264, has been established for almost 50 years, has an average attendance of about 250 pupils, and costs, on an average, \$40,000 annually; the Illinois Institution for the Education of the Deaf and Dumb cost \$495,500, was established in 1841, has an average of 600 pupils in attendance, and costs the state about \$100,000 annually; the Illinois Central Hospital for the Insane cost the state \$927,000, has, on an average, from 1,400 to 1,500 patients, and requires

about \$186,000 annually. These three institutions are all located at Jacksonville, a city in the west-central portion of the state, about 50 miles from the Mississippi river. The Illinois Asylum for Feeble-minded Children, located at Lincoln, Logan County, was established in 1865, cost \$210,600, cares for about 700 unfortunate children between the ages of 6 and 18 years, and requires state aid to the amount of about \$120,000 annually. The Illinois Soldiers' and Sailors' Home, located at Quincy, in the west-central part of the state, on the Mississippi River, cost almost \$300,000, has a varying population, ranging from 900 to 1,000, and requires about \$140,000 per annum from the state, in addition to \$100 per annum, which is paid by the general gov-

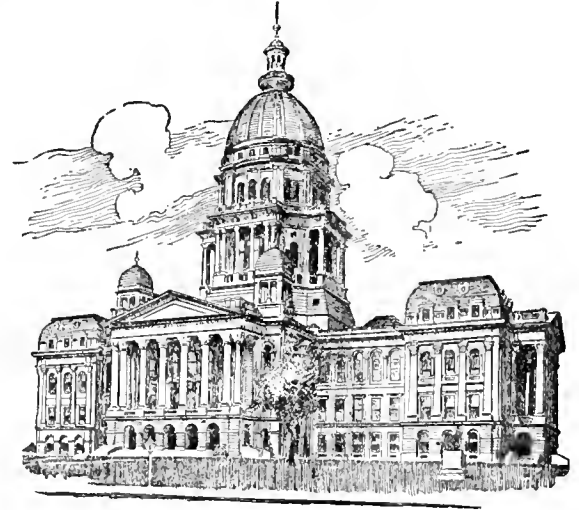

STATE CAPITOL, SPRINGFIELD.

ernment for each inmate. The Illinois Soldiers' Orphans' Home, established soon after the close of the Civil War, located at Normal, in McLean County, in the north-central part of the state, cost about \$175,000, assumes the care of from 500 to 600 children, necessitating an annual outlay on the part of the state of about \$50,000. The Illinois Eastern Hospital for the Insane, at Kankakee, a town in the northeastern part of the state, near the Indiana border, and about 50 miles south of Chicago, cost for construction about \$1,340,000, has on an average 2,000 patients under treatment, costing the state about \$360,000 for its yearly running expenses. The Illinois Northern Hospital for the Insane, at Elgin, a city about 35 miles west-northwest of Chicago, cost near \$650,000, has an average attendance of about 1,100 patients, and calls for about \$145,000 annually. The Southern Hospital for the Insane, at Anna, in Union County, the extreme southern part of the state, has been destroyed by fire and rebuilt, the two constructions costing about \$750,000. The average attendance of patients is between 900 and 1,000, whose maintenance demands from the state about \$180,000 annually. The Illinois Asylum for Insane Criminals, located at Chester, on the Mississippi River, in the extreme southwestern portion of the state, has been in operation only since 1890, but within that time has reached an average of consider-

ably over 100 patients, requiring the expenditure of about \$30,000 annually by the state. The Illinois Charitable Eye and Ear Infirmary, on the corner of Adams and Peoria streets, Chicago, cost nearly \$300,000, treats annually from 7,000 to 8,000 patients, and receives from the state about \$25,000 per year. In the 22 years of its existence the infirmary has treated over 100,000 patients and gives free attention to those unable to pay for the same.

The 11 charitable institutions above named cost for maintenance, during the year 1895, the sum of \$1,255,089, received from sources other than the state the sum of \$111,267, leaving for payment by legislative appropriation \$1,143,821. The site for a new hospital for the insane, to be called the Western, has been chosen at Watertown, near Rock Island. Other charitable institutions are the Illinois Industrial Home for the Blind in Chicago and the Industrial Home for Girls. The legislature made an appropriation of \$100,000 for its construction in 1893, and the institution, opened in 1897, furnishes employment for the blind who are able to engage in some mechanical pursuit. The home for girls is located at Evanston, a suburb of Chicago, and accommodates about 100.

The Illinois State Penitentiary at Joliet has on an average about 1,400 inmates, the Southern Illinois Penitentiary at Chester has about 650, and the Illinois State Reformatory at Pontiac, in Livingston County, about 75 miles southwest of Chicago, has from 750 to 800 convicts, ranging in age from 10 to 21 years.

The church statistics for the year 1890, as furnished by the Federal census, show Illinois fourth among the states, with 8,296 organizations; fourth in edifices, with 7,352 church buildings; fifth in the value of church property, the sum, total being \$39,715,245, and fourth in communicants, having 1,202,588 members. The 8,296 organizations are made up from 68 different denominations and 8 independent congregations. The Methodist Episcopal leads in the number of organizations, having 1,903; the Baptists come next, with 966; the Roman Catholics next, with 688. Other organizations are the Disciples of Christ, 641; Presbyterians in the United States of America, 472; United Brethren, 320; Congregational, 302; Lutheran, Synodical Conference, 250; Cumberland Presbyterians, 198; Protestant Episcopal, 186; German Evangelical Synod of North America, 164; and Lutheran, General Council, 141.

At the beginning of 1899 there were 1,728 newspapers published in Illinois; 612 of the cities, towns, and villages of the state had newspapers, every county and every county capital having periodicals. Of the entire number of papers 183 were daily, 1 triweekly, 40 semiweekly, 1,213 weekly, 10 fortnightly, 24 semimonthly, 241 monthly, 1 eight times a year, 4 bimonthly, and 11 quarterly.

There were 2,577 post offices in the state, June 30, 1898, of which 10 were first-class, 46 second-class, 204 third-class, 2,317 fourth-class, and 1,477 were money-order offices.

The principal cities of the state are Chicago

city (1900), 1,608,575; Peoria, 56,100; Quincy, 36,252; Springfield, the capital, 34,159; Rockford, 31,051; Joliet, 29,353; Bloomington, 23,286; Aurora, 24,147; Elgin, 22,433; Decatur, 20,754; Belleville, 17,484; Galesburg, 18,607; East St. Louis, 29,655; Rock Island, 19,493; Jacksonville, 15,078; Moline, 17,248; Danville, 16,354; Streator, 14,079; Cairo, 12,566; Alton, 14,210; Freeport, 13,258; Ottawa, 10,588; LaSalle, 10,446; Kankakee, 13,595; Mattoon, 9,662; and Evanston, 19,259.

The following is a list of the governors of Illinois since its admission into the Union in 1818, with their terms of office: Shadrach Bond, 1818-22; Edward Coles, 1822-26; Ninian Edwards, 1826-30; John Reynolds, 1830-34; William L. D. Ewing, 1834; Joseph Duncan, 1834-38; Thomas Carlin, 1838-42; Thomas Ford, 1842-46; Augustus C. French, 1846-53; Joel A. Matteson, 1853-57; William H. Bissell, 1857-60; John Wood, 1860-61; Richard Yates, 1861-65; Richard J. Oglesby, 1865-69; John M. Palmer, 1869-73; Richard J. Oglesby, 1873; John L. Beveridge, 1873-77; Shelby M. Cullom, 1877-83; John M. Hamilton, 1883-85; Richard J. Oglesby, 1885-89; Joseph W. Fifer, 1889-93; John P. Altgeld, 1893-97; John R. Tanner, 1897. See also ILLINOIS, Vol. XII, pp. 703-706.

ILLINOIS, UNIVERSITY OF (ILLINOIS INDUSTRIAL UNIVERSITY until July 1, 1885), at Urbana, 128 miles from Chicago; was established under acts of Congress of July, 1862, and July, 1866, and under acts of the legislature of Illinois, Jan. 25, Feb. 28, and March 8, 1867, to "teach in the most thorough manner such branches of learning

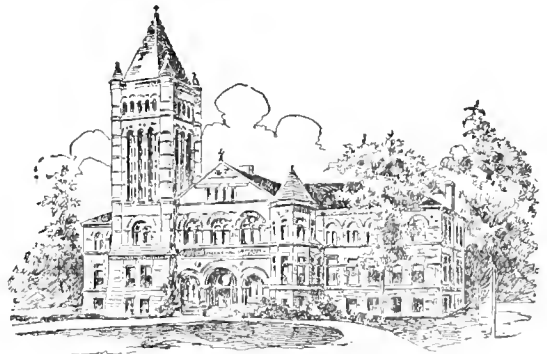

UNIVERSITY OF ILLINOIS.

as are related to agriculture and the mechanic arts, including military tactics, and not excluding other scientific or literary studies." The state received scrip for 480,000 acres of land. The county and the Illinois Central railroad made large appropriations; the State gave \$879,000. The University was incorporated in 1867, and opened in 1868, and three years later women were admitted as students. It includes the following colleges and schools: College of agriculture and horticulture; college of civil, mechanical and mining engineering, and architecture; college of natural sciences, chemistry, and natural history; college of literature and art; school of military science; and school of industrial art. The assets of the University are about \$1,372,000,

with a total income in 1898 of \$354,982. Its students now (1899) number 1,750; it has 214 instructors, and a library of 50,000 volumes.

ILLINOIS AND MICHIGAN CANAL. See CANAL, in these Supplements.

ILLINOIS RIVER, the largest stream in Illinois, formed by the Desplaines and Kankakee rivers, which unite in Grundy Co.; flows southwest to the Mississippi 16 miles above Alton; about 350 miles long; navigable in favorable seasons as far as Peru, 250 miles; connected by a canal, 66 miles long, with Lake Michigan at Chicago. See also CANAL, in these Supplements.

ILLUMINATED MANUSCRIPTS. See ILLUMINATION, Vol. XII, pp. 707-09.

ILLUMINATING APPARATUS, SURGEONS'. An illuminator, attachable to a student's lamp, gas-jet, or other source of light, is made with a bracket-stand, supporting a bull's-eye condenser, adjusted on a line with the light, and bearing a mirror adjustable on a rod, so that it may reflect the light into a patient's mouth, ear, etc. These are used extensively in laryngeal operations. For more difficult explorations a photophore bearing a small incandescent electric light is used to examine all the openings of the body. The laryngeal electric photophore is a simple rod bearing the light on the tip, and a small adjustable mirror beside or in advance of the light. A tongue-depressor is also made with a similar light.

ILLUSION. See MAGIC, Vol. XV, pp. 207-11.

ILLUSIONS. See PSYCHOLOGY, Vol. XX, p. 63.

ILLUSTRATION. See ENGRAVING, in these Supplements.

ILMEN. See NOVGOROD, Vol. XVII, pp. 606-07.

ILMENITE. See MINERALOGY, Vol. XVI, p. 386.

ILOILO, a seaport town, the capital of the populous province of Iloilo, on the southeast coast of the island of Panay, Philippine Islands, on the strait separating Panay from the small island of Guimaras. It is one of the only three ports in the islands (Manila and Cebu being the other two) at which foreign vessels have hitherto loaded. The port is a safe one, and the inner harbor has a depth of 14 feet at average high tide. Vessels load and discharge by means of lighters. The chief exports are sugar, hemp, canes, sapan-wood, and tobacco. After the signature of the treaty of peace between Spain and the United States, Dec. 10, 1898, by which the Philippines were ceded to the latter Power, the Spaniards, on Dec. 23, surrendered Iloilo to the Filipino insurgents, who had been besieging the town, and who ignored the treaty, and declined to deliver up the place to the American troops sent to occupy it, and even refused to allow them to land. On Feb. 11, 1899, however, the American forces under General Marcus P. Miller captured the town without loss. Pop. from 12,000 to 24,000.

ILOPANGO. See SAN SALVADOR, Vol. XXI.

IMAGO. See BUTTERFLIES, Vol. IV, p. 592.

IMBABURA. See ECUADOR, Vol. VII, p. 646.

IMBECILITY. See INSANITY, Vol. XIII, 97-98.

IMBRIANO, Italian patriot and litterateur; born in Naples, Oct. 24, 1840; abandoned his college course to follow Garibaldi in the campaign of 1860. His criticisms of modern writers were pungent and combative. They have been collected under the

titles of *Fame Usurpate* (1877), and *Appunti Critici* (1878); some powerful verse of his is included in *Esercizi di Prosodia*; his best work, however, is his collection of popular poetry under the title of *Canti Popolari delle Provincie Meridionali* (2 vols., 1871-72); *Dodici Canti Pomiglianesi* (1877); *La Novellaja Milanese* (1872); *La Novellaja Fiorentina* (1877). He died Jan. 1, 1886.

IMITATION, IN ART. See FINE ARTS, Vol. XI, pp. 202-211.

IMMIGRATION INTO THE UNITED STATES OF AMERICA. (For general article on this subject, see EMIGRATION, Vol. VIII, pp. 173-177; and UNITED STATES, Vol. XXIII, pp. 821, 822.) The laws of Congress governing immigration are summarized as follows:

1. There shall be collected a duty of one dollar from each passenger not a citizen of the United States who shall come by steam or sail vessel from a foreign port to any port within the United States, the money thus collected to constitute an immigration fund, for the care and relief of immigrants in distress and for the expense of regulating immigration under the immigration laws.

2. The following classes are excluded from admission to the United States: All idiots, insane persons, paupers or persons likely to become a public charge; persons suffering from a loathsome or dangerous contagious disease; persons who have been convicted of a felony or other infamous crime or misdemeanor involving moral turpitude; and polygamists; also, under the Lodge act of 1898, all persons unable to read or write. But persons convicted of a political offense shall not be excluded, whatever be the name of the offense by the laws of the land whence they come.

3. It shall be unlawful for any person, company, partnership or corporation to assist in any way any foreigner into the United States under contract or agreement made previous to the importation of such alien to perform labor or service of any kind in the United States. The penalty is one thousand dollars for each offense. Masters of vessels who shall knowingly bring to the United States such excluded persons may be fined for each offense five hundred dollars, and may also be imprisoned for a term not exceeding six months. But skilled workmen from foreign countries may be imported for the purpose of labor in any new industry to be established, provided such labor cannot be otherwise obtained. This provision of the law does not apply to actors, artists, clergymen, lecturers, singers or domestic servants.

4. The importation into the United States of women for the purpose of prostitution is forbidden. The penalty for the offense is imprisonment not exceeding five years and a fine not exceeding five thousand dollars.

5. All persons excluded by law shall, upon arrival, be sent back to the countries to which they belong or whence they came. The expense of such return shall be borne by the owners of the vessels in which they came. In case an immigrant has been allowed to land contrary to law,

such immigrant may, within one year after landing, be taken into custody and returned to the country whence he came, at the expense of the importing vessel. Any alien who becomes a public charge within one year after his arrival in the United States, from causes existing prior to his landing, may be returned to the country whence he came.

6. The Secretary of the Treasury is charged with the duty of executing the laws relating to immigration, and he has the power to enter into contracts with such state commissions, boards or officers as may be designated by the governor of any state, under the rules and regulations prescribed by the Secretary. The Secretary may designate the state board of charities of any state, or any person or persons in any state, whose duty it shall be to execute the provisions of the immigration laws; and the Secretary may prescribe regulations for carrying into effect the provisions of the law.

With regard to insane persons, idiots, paupers and convicts there is evidence that hundreds have gained admission to the United States who should have been excluded. They were shipped from Europe by the authorities of cities and towns, or by so-called benevolent societies. By the same agencies convicts have also been sent to the United States. In 1891 there was shipped to America by the authorities of a town in Germany a convicted murderer, who had been in prison one year and in an insane asylum twenty-four years. In Austria, many persons convicted of crime have been given the alternative of going to prison or emigrating to America. Since 1884 the Board of Charities of the state of New York has returned to Europe more than six hundred lunatics, imbeciles and feeble-minded persons who had been shipped to the United States, in many cases with through tickets to interior towns. The number of insane in the state of New York in 1880 was 9,537 and in 1890, 16,022, an increase in 10 years of 68 per cent. During the same time the increase in population was only 18 per cent. It was therefore the belief of the Board of Charities that the greater part of this increase was due to the shipment of insane persons from the countries of Europe. Since the passage of the act of 1893 concerning the return of paupers, convicts, etc., to the countries whence they came, the German, Italian and some other European governments have established stations along their frontiers for the examination by the police of those about to emigrate. If found liable to be refused by the American authorities, permission to proceed to the seaports is refused. These governments have also decreed that transportation lines shall at their own expense return immigrants rejected by the United States.

After the passage of the immigration act of 1893 it was represented to the bureau of immigration that undesirable immigration would seek Canadian routes and enter the United States across the frontier. To protect the United States from such possible invasion and to prevent the importation of

laborers under contract, the superintendent of immigration made an agreement with the steamship lines plying between European and Canadian ports, and the railway lines in Canada, that all immigrants destined to the United States shall be landed at certain Canadian ports; that United States officers may inspect such immigrants at the ports of entry and furnish a certificate or passport entitling them to cross the frontier and enter the United States; that the railway companies shall not transport immigrants to the frontier without such passport; and that to defray the expenses of such inspection there shall be paid by the transportation lines to the inspectors 50 cents for each immigrant admitted to the United States; and this fee shall be the only charge for entering the United States. To carry out this agreement, inspectors have been located at Quebec in summer and Halifax in winter, at Vancouver and Victoria, British Columbia, and at the several ports of entry along the Canadian border. This agreement may be terminated by either party at the expiration of 60 days' notice. Statistics of immigrants entering the United States from Canada had not been kept prior to October, 1893, but from Canadian sources it is ascertained that from 40,000 to 50,000 Europeans entered the United States who landed at Quebec and Halifax during the twelve months preceding that date. From October, 1893, to June 30, 1894, only 7,771 landed in Canada destined to the United States, and for the year ending June 30, 1895, only 5,988.

The following table shows the official summaries by decades from 1820 to 1889 inclusive, and by years from 1890 to 1897 inclusive. Immigrants from British North America and Mexico are not included since 1885, except for the years 1896-97:

YEARS.	NUMBER OF IMMIGRANTS.	PER CENT INCREASE.	PER CENT DECREASE.
1780-1820 (estimated)	250,000	.....	.....
1820-29	128,502	.....	.....
1830-39	538,381	411	..
1840-49	1,427,337	265	..
1850-59	2,799,329	198	..
1860-69	2,041,459	..	28
1870-79	2,742,137	134	..
1880-89	5,248,568	191	..
1890	455,302	.....	.....
1891	560,319	123	..
1892	579,663	103	..
1893	439,739	..	24
1894	285,631	..	35
1895	258,536	..	10
1896	343,267	132	..
1897	230,832	..	33
Grand total.	18,328,993	.....	.....

A number of causes have operated to vary the immigration from year to year. For example, in the years 1845-47 the famine in Ireland compelled thousands to emigrate to America—as many as 105,955 in 1846 and 215,444 in 1847. In 1861-62 the number of immigrants diminished nearly one-half from that of 1860, owing to the

Civil War. The greatest number for any one year was in 1882, being 788,992. From that year to 1892 the number gradually decreased from year to year, owing largely to the enactment by Congress of more stringent immigration laws. In 1893 United States inspectors at Canadian ports still further decreased the number, as stated above; and the quarantine and detention of passengers from cholera-infected European countries resulted in the refusal of steamship companies to embark immigrants. The chief cause operating constantly to produce fluctuations in the stream of immigration is the comparative industrial conditions in the United States and foreign countries. The decrease of immigration in 1894 is largely to be attributed to the stagnant condition of business enterprises, owing to financial causes and the consequent absence of demand for both skilled and unskilled labor in the United States.

The following table, showing the immigration from those European countries which of late years have contributed the greatest numbers, will be of interest, as exhibiting the extent and the direction of the fluctuations for the years 1892-96.

COUNTRIES.	1893.	1894.	1895.	1896.	1897.
Poland and Russia.....	57,492	39,646	35,510	52,536	29,981
Great Britain.....	59,853	37,968	39,752	24,556	12,727
Ireland.....	49,223	33,904	47,972	40,262	28,421
Germany.....	96,361	59,389	36,351	31,885	25,533
Italy.....	72,916	43,967	39,961	68,060	59,431
Austria-Hungary.....	59,633	37,505	33,462	65,103	33,931

The following is a summary of the official report of the Commissioner-General of Immigration for the ports of the United States and Canada for the year ending June 30, 1896. It is very suggestive, as showing the nationality of the immigrants, their illiteracy, the amount of money they brought over, their destination in the states and territories, and their occupations:

NATIONALITY.	TOTAL NUMBER.	UNDER 15 YEARS.	CAN NEITHER READ NOR WRITE	AMOUNT OF MONEY BROUGHT.
Austria-Hungary—Bohemia and Moravia .....	2,709	613	231	\$67,298
Galicia and Bukovina .....	12,696	1,531	6,107	127,763
Other Austria .....	18,800	2,539	5,481	190,295
Hungary.....	39,298	3,367	12,154	371,471
Belgium .....	1,261	258	144	33,097
Denmark .....	3,167	438	24	53,200
France (including Corsica).....	2,463	351	95	100,571
Germany.....	31,885	6,551	713	900,511
Greece .....	2,175	191	517	29,343
Italy .....	68,060	10,545	31,374	598,705
Netherlands .....	1,583	431	48	21,328
Norway .....	8,855	1,937	57	91,159
Portugal .....	2,766	699	1,589	42,118
Roumania.....	785	181	125	12,061
Russia (proper).....	45,137	9,939	12,816	303,335
Finland .....	6,308	732	385	68,402
Poland.....	691	174	230	8,174
Spain .....	351	22	33	22,557

NATIONALITY.	TOTAL NUMBER.	UNDER 15 YEARS.	CAN NEITHER READ NOR WRITE	AMOUNT OF MONEY BROUGHT.
Sweden .....	21,177	2,353	146	320,355
Switzerland .....	2,304	282	16	77,616
Turkey in Europe.....	169	29	49	4,031
United Kingdom—England .....	19,492	3,870	757	413,439
Ireland .....	40,262	2,766	2,473	524,589
Scotland .....	3,483	677	119	59,233
Wales.....	1,581	441	139	35,016
Not specified .....	9	6	—	49
<b>Total Europe.....</b>	<b>329,067</b>	<b>59,023</b>	<b>75,813</b>	<b>\$4,479,802</b>
Mexico.....	150	35	23	\$3,470
British Honduras.....	5	2	—	\$55
Costa Rica .....	3	—	—	170
Guatemala .....	1	—	—	—
Honduras .....	2	—	—	60
Nicaragua.....	1	1	—	—
Salvador .....	5	1	1	670
<b>Total Cen. Amer.</b>	<b>17</b>	<b>4</b>	<b>1</b>	<b>\$955</b>
Quebec and Ontario.....	191	23	10	\$3,759
Nova Scotia .....	23	4	—	545
New Brunswick .....	9	1	—	30
British Columbia .....	22	16	—	5,080
Newfoundland and Labrador.....	28	7	—	350
<b>Total Brit. North Am. Possess'ns</b>	<b>273</b>	<b>41</b>	<b>10</b>	<b>\$9,764</b>
Cuba .....	6,077	1,642	478	\$213,371
Other West Indies.....	751	112	109	7,508
South America .....	35	6	2	1,400
Turkey in Asia (Arabia and Syria).....	4,139	757	1,566	75,432
China .....	1,441	57	65	38,170
Japan .....	1,110	29	56	62,643
Asia, not specified .....	74	3	3	7,223
Australia.....	87	26	2	16,149
Hawaiian Islands .....	23	2	—	775
Pacific islands, not specified.....	2	—	—	125
Africa.....	21	4	2	531
<b>Grand total .....</b>	<b>343,267</b>	<b>52,741</b>	<b>78,130</b>	<b>\$4,917,318</b>

## DESTINATION OF IMMIGRANTS.

STATES AND TERRITORIES.	NUMBER. (Male and Female.)	STATES AND TERRITORIES.	NUMBER. (Male and Female.)
<i>North Atlantic Division.</i>		Virginia .....	335
Maine .....	764	West Virginia.....	437
New Hampshire.....	873	North Carolina.....	87
Vermont .....	436	South Carolina.....	69
Massachusetts.....	36,561	Georgia .....	472
Rhode Island .....	5,623	Florida .....	7,159
Connecticut .....	11,175	<b>Total .....</b>	<b>12,893</b>
New York .....	127,082	<i>North Central Division.</i>	
New Jersey.....	15,506	Ohio .....	8,047
Pennsylvania.....	61,007	Indiana .....	1,944
<b>Total .....</b>	<b>259,027</b>	Illinois .....	22,093
<i>South Atlantic Division.</i>		Michigan .....	6,013
Delaware .....	454	Wisconsin .....	4,572
Maryland .....	3,494	Minnesota.....	5,974
District of Columbia .....	386	Iowa .....	3,029
		Missouri.....	2,485
		North Dakota.....	1,080



DESTINATION OF IMMIGRANTS—continued.

STATES AND TERRITORIES.	NUMBER. (Male and Female.)	STATES AND TERRITORIES.	NUMBER. (Male and Female.)
<i>North Central Divis.—continued.</i>			
South Dakota	613	New Mexico	98
Nebraska	1,043	Arizona	92
Kansas	690	Utah	206
Total	57,583	Nevada	107
<i>South Central Division.</i>			
Kentucky	330	Idaho	118
Tennessee	140	Washington	605
Alabama	219	Oregon	678
Mississippi	85	California	4,914
Louisiana	1,516	Total	9,437
Texas	1,345	RECAPITULATION.	
Oklahoma	38	North Atlantic Division	259,027
Arkansas	654	South Atlantic Division	12,893
Total	4,327	North Central Division	57,583
<i>Western Division.</i>			
Montana	920	South Central Division	4,327
Wyoming	226	Western Division	9,437
Colorado	1,473	Total	343,267

OCCUPATIONS OF IMMIGRANTS.

<i>Professional.</i>		<i>Skilled—Continued.</i>	
Actors	29	Shipwrights	30
Artists	113	Shoemakers	3,952
Clergy	148	Spinners	583
Editors	19	Stonecutters	442
Engravers	41	Tailors	4,021
Lawyers	50	Tanners and curriers	252
Musicians	331	Tinners	397
Physicians	146	Tobacco manufacturers	1,041
Sculptors	133	Watch and clock makers	278
Teachers	399	Weavers	1,957
All other, not specified	915	Wheelwrights	113
Total professional	2,324	All other, not specified	3,531
<i>Skilled.</i>		Total skilled	46,807
Accountants, etc.	87	<i>Miscellaneous.</i>	
Bakers	1,679	Agents, factors	264
Barbers and hair-dressers	1,375	Bankers	9
Blacksmiths	1,393	Cooks	1,202
Brewers	273	Farmers	29,251
Butchers	1,440	Grocers	527
Cabinet-makers	243	Hotel-keepers	106
Carpenters and joiners	3,676	Laborers	91,262
Clerks	2,112	Merchants, dealers	5,268
Coopers	175	Servants	38,926
Dressmakers	1,200	Shepherds	41
Engineers	710	All other, not stated	4,084
Gardeners	599	Total, miscellaneous	170,940
Glaziers	240	Not stated	168
Iron-workers	461	No occupation, including women and children	123,028
Jewelers	127	RECAPITULATION.	
Locksmiths	626	Professional	2,324
Machinists	534	Skilled	46,807
Mariners	4,335	Miscellaneous	170,940
Masons	1,782	Not stated	168
Mechanics, not specified	1,021	No occupation	123,028
Millers	491	Total	343,267
Miners	2,698		
Painters	1,051		
Plasterers	106		
Plumbers	117		
Printers	280		
Saddlers and harness-makers	266		
Seamstresses	1,035		

Of the total number of immigrants, as above reported, 38 per cent. were females; a little more than 10 per cent. were over 40 years of age; about 51 per cent., over 20 years of age, brought less than \$30 each; nearly 20 per cent. were from Italy, which sent more than any other foreign country; over 37 per cent settled in the state of New York, which absorbed a greater number than any other state. One was an idiot; 10 were insane; 2,010 were paupers or likely to become a public charge; 776 were contract laborers; and 238 were returned within one year after landing. Nearly 23 per cent. could neither read nor write.

IMMORTALITY. See BUTLER, Vol. IV, pp. 584, 585; ESCHATOLOGY, Vol. VIII, pp. 537, 538; PLATO, Vol. XIX, pp. 199, 200, 209, 210; Brahman idea of, VEDANTA, Vol. XXIV, pp. 118, 119.

IMPATIENS, a genus of the family *Geraniaceae*, or geraniums, although some botanists separate it as a distinct family, *I. balsamina*, or garden balsam, from India, is well known in cultivation. The two species indigenous in the United States are *I. pallida* and *I. fulva*, common in wet ground and moist, shady places. The genus is known by its delicate, tender foliage and irregular flowers, but most by the fact that its pods suddenly burst when touched, giving rise to the common name "touch-me-not." The species are also known as "jewel-weeds."

IMPENETRABILITY. See ATOM, Vol. III, p. 38.

IMPENNES. See ORNITHOLOGY, Vol. XVIII, p. 45.

IMPERATOR. See EMPEROR, Vol. VIII, pp. 179, 180.

IMPERIALINE, an alkaloid obtained from the bulb of the poisonous plant Crown Imperial (*Fritillaria imperialis*). It is, when first obtained, in the form of a yellow precipitate, but from the alcoholic solution crystallizes in short, colorless needles with a composition of C<sup>35</sup>H<sup>60</sup>NO<sup>4</sup>. The crystals are not readily soluble in water, but yield to ether, chloroform, and alcohol. A chloride has been obtained, which makes bitter solutions with alcohol and water, and forms salts with platinum and gold. The discoverer was Dr. Fragner, of Prague.

IMPERIAL INSTITUTE, a London organization of some importance, started in 1887, as a memorial of Queen Victoria's Jubilee. Its aims consist of the formation of a complete collection of the natural products of the British Empire, the establishment of a system of commercial intelligence to work with and supplement the display of the specimens, and the practical adaptation of both the purposes and advancement of trade. To facilitate the work of the organization, a superb building was erected in London by public subscription, and formally inaugurated by the Queen, May 11, 1893. The institution is governed by 125 trustees, called *governors*, and appointed by the crown, by the colonial governor, by county and municipal authorities in the United Kingdom and by learned societies. There are 8,000 Fellows—of either sex—who acquire the title by

vote of the governors and the payment of £2 a year; ladies and colonial Fellows £1 only. The collections have quickly grown to huge proportions, and are being increased constantly. There are lectures by the best speakers in various branches; also indoor and outdoor concerts by famous orchestras. *The Imperial Institute Annual* is a valuable yearly compilation of information and statistics concerning British colonies; *The Imperial Institute Journal* is a monthly, ably edited, and a record-keeper of the trade, commerce, finance and agriculture of the British Empire. Frequent expositions are held in the halls and grounds of the Institute, and attract large crowds. At certain hours every day the Institute is free to all comers; the rest of the time a fee of one shilling is exacted; and on Thursdays, Fellows and their friends only are admitted. In many respects it has the conveniences of a high-class club-house for both sexes.

IMPETIGO. See SKIN DISEASES, Vol. XXII, p. 123.

IMPEY, SIR ELIJAH. See HASTINGS, WARREN, Vol. XI, pp. 512-518.

IMPEYAN PHEASANT, a beautifully colored pheasant (*Lophophorus impeyanus*), native of the elevated regions of northern India and the Himalayas. The natives call it the monaul, which means bird-of-gold. It was named from Sir Elijah Impey, who first attempted transporting living birds to Europe. The bird is sometimes domesticated.

IMPRESSIONISM, a theory in art which has been adopted as a creed by a school of French painters, among whom Courbet and Manet (q.v.) attained a high reputation. The original exponents of this doctrine affirmed that the too close observation of nature causes a weakening in one's power of realization, and that even colors change when gazed at for too long a time. They claimed that a properly trained eye, or rather an unsophisticated eye, will see things, both in shape and coloring, under an aspect radically different from that commonly observed and rendered by pencil or brush. It is certain that the efforts of many artists of the new school to realize their impressions have produced results that have astounded and oftentimes greatly amused the on-lookers. But it is just as true that the persistent efforts of the young school of impressionism have brought about a partial revolution in the teaching of the plastic arts, and have made away, to a great extent, with that minute copying of details, at the expense of a broad and far-reaching grasp of the whole, that characterized for centuries the average painter and sculptor. That a clever sketch is often, if not always, closer to nature than an ultra-finished painting, needs no demonstration; on the other hand, the Impressionists number among their growing cohorts many artists who make a habit and a boast of replacing hard work and long study of their art by a certain crude dash, the shallow brilliancy of which often deceives the unwary. The theory they proclaim is in itself logical and deserving of respect; but it

does not do away with arduous labor and persistent application in the search of the true, the harmonious and the beautiful.

IMPRESSMENT. See NAVY, Vol. XVII, p. 295.

IMPROVISATION. See POETRY, Vol. XIX, p. 272; and MUSIC, Vol. XVII, p. 90, note.

IMPULSE, IN MOTION. See MECHANICS, Vol. XV, pp. 735, 736.

IMPUTATION, a theological doctrine that is exalted or obscured as the mind of man works on formal or on vital lines. It is founded on the fourth chapter of Romans, in which the Douay version of the New Testament, with the exception of a quotation from the Psalms, uses the word "repute" where the authorized version says "impute." The change works no real alteration in the moral content of the apostolic argument. A new sense came to the word "impute," under the tremendous subjection of the mediæval mind to judicial forms, a subjection that gives appalling character to the thirteenth-century hymn of Celano, *Dies Irae*, and to the theology of that time. The doctrine of imputation conceives of God as a judge, acting with judicial forms and records. The guilt of Adam, incurred in his primal disobedience, and which is deserving of endless wrath, is imputed to or charged upon each of his descendants as if he himself had done the deed. In a like formal, but in a compensating manner, the Almighty Judge reckons the meritorious obedience of the Saviour to those who believe on him and are regenerated by the Holy Ghost. This imputation of Christ's righteousness constitutes the believer's title to grace and everlasting felicity. The doctrine would lead to antinomianism if it were left in this bare tribunitial form; but all theologians who teach it, associate it inextricably with the spiritual content of a depraved nature working a guiltiness of its own on the one side, and of a soul imbued with the spirit of Christ on the other. The most rigid and formal statement of imputation is to be found in Calvinistic authors, but they now seldom bring it forward in terms, although that for which it stands is the doctrine of all orthodox Christianity. A modified view of this tenet is known as "mediate imputation," in which not the guilt but the consequences of the first sin of the race attaches to every man. The distinction has no logical or real value. Eternal damnation on account of Adam's misconduct gains no alleviations from refinements of definition.

INACHUS, in Greek mythology, the first king and most ancient hero of Argos, whence the country is often called, in ancient poets, the Land of Inachus. He sometimes was supposed to have been the leader of an Egyptian or Lybian colony, which settled on the banks of the Inachus, a river rising from the Mt. Lyrcæus on the borders of Arcadia.

INAGUA, GREAT and LITTLE, two islands of the Bahama group, the former being the largest and most southerly of the chain. Great Inagua lies in lat. 21° 10' N., long. 73° 30' W., is 50

miles long and 25 wide. Little Inagua lies 12 miles N. of North East Point, and is about 6 by 8 miles. These islands are low and have salt marshes. Navigation about them is dangerous on account of the surrounding reefs. Area, 705 square miles. Population, 1,000.

INARCHING. See HORTICULTURE, Vol. XII, p. 236.

INCAN ANTIQUITIES. See PERU, Vol. XVIII, p. 677; and ECUADOR, Vol. VII, p. 648.

INCANDESCENT LIGHT. See LIGHTING, ELECTRIC, Vol. XIV, pp. 579, 632.

INCANTATION. See MAGIC, Vol. XV, pp. 199, 200.

INCARNATION. See GOSPELS, Vol. X, p. 810; also, CHRISTOLOGY, in these Supplements.

INCAS. See PERU, Vol. XVIII, p. 677.

INCINERATION. See CREMATION, in these Supplements.

INCLINED PLANE. See MECHANICS, Vol. XV, p. 704.

IN COENA DOMINI, a collection of church censures or anathemas against heretics, schismatics, sacrilegious persons, pirates, forgers and highway robbers; called a bull, although the work of no particular pope, and even of uncertain date; takes its name from its first Latin words, "at the Lord's Supper"; until 1770 it was customary to have it read in every Roman Catholic church on Holy Thursday, the anniversary of the first eucharistic feast. Several European governments opposed it as an infringement on the secular power. Finally it was replaced by a less comprehensive document, which was ordered read in all churches on Easter Monday.

INCOME TAX, a tax imposed upon annual incomes or the yearly revenue derived from labor, business enterprises, investments and other sources of income. This method of taxation was resorted to in mediæval times with more or less frequency, but did not become of general use throughout the world until the early part of the nineteenth century. The first instance of this class of tax in America was probably that of Massachusetts Bay Colony, which established such a tax in 1646. The colony, afterward the state of Massachusetts, retained the tax upon incomes among its laws, with frequent modifications and alterations, during most of the time since, and is one of the few states in which this class of taxes is now imposed. The first income tax in Great Britain in modern times was that of 1799, which was levied upon all incomes of over £200 per annum, at the rate of 10 per cent upon the excess of that amount, with a less rate, gradually decreasing, on incomes ranging between £200 and £60. Below £60 no tax was imposed. In 1842 another income-tax law was enacted, which, with modifications, still exists.

At the present time in England, incomes in excess of £150 per annum are taxed, but those between £150 and £500 are subject to an abatement from the regular rate of taxation.

At the present time taxes are imposed in some form upon incomes in the following countries:

England, Holland, Switzerland and the various states of Germany and Austria. Some of the states of the United States impose income taxes, and in others they have constitutional provisions authorizing the legislature to impose such taxes. Massachusetts, Virginia and North Carolina are the states in which incomes are taxed, while there are constitutional provisions authorizing income taxes in Tennessee, Texas and California.

The first attempt by the Congress of the United States to impose an income tax was in 1861. The law which levied a direct tax for the support of the war contained a provision for a tax of 3 per cent on the excess of all incomes above \$800. This tax, however, was not collected. The following year, Congress imposed an income tax of 3 per cent upon the excess of all incomes above \$600 up to \$10,000, and 5 per cent above \$10,000. In 1864 the rate was increased upon incomes between \$600 and \$5,000 to 5 per cent; between \$5,000 and \$10,000, to 7½ per cent; and over \$10,000, to 10 per cent. In the fall of the same year a special income tax was imposed upon all incomes in excess of \$600, to apply to the incomes of the preceding year only. In 1865 the rate was again increased to 10 per cent on incomes in excess of \$5,000. In 1867 an income tax of 5 per cent was imposed only upon the excess of incomes above \$1,000 per annum, which was again reduced, in 1870, to 2½ per cent for that and the following year, at which time the law expired.

No attempt was made thereafter to impose an income tax until 1894, when by act of Congress of August 28th of that year, a tax of 2 per cent was imposed upon the excess of all incomes above \$4,000 per annum, and upon incomes of all corporations, companies and associations other than partnerships. On May 20, 1895, this law was declared to be unconstitutional and void by the Supreme Court of the United States in the case of *Pollock vs. Farmers' Loan and Trust Company*, reported in the 159th volume of the United States Supreme Court Reports.

The decision was: 1. That taxes on real estate being indisputably direct taxes, taxes on the rents or income of real estate were equally direct taxes.

2. That taxes on personal property or on the income of personal property were likewise direct taxes.

3. That the tax imposed by sections twenty-seven to thirty-seven, inclusive (all the income tax sections), of the act of 1894, so far as it fell on the income of real estate and of personal property, being a direct tax within the meaning of the constitution, and therefore unconstitutional and void, because not apportioned according to representation, all those sections, constituting one entire scheme of taxation, were necessarily invalid. Thus the whole act was declared unconstitutional and void, a decision which created much consternation among the government officials, as it cut off a vast source of revenue to the Federal government, and tended largely to

create a deficit in the funds of the nation. This effect was aided by the fact that the same Congress which imposed the income tax greatly reduced the tariff upon imported goods, relying upon the income tax to make up the deficiency which the tariff reduction would create. See also FINANCE, Vol. IX, pp. 187, 188; PEEL, ROBERT, Vol. XVIII, p. 456; PRUSSIA, Vol. XX, p. 19; and TAXATION, Vol. XXIII, pp. 85-89.

INCOMMENSURABLE. See GEOMETRY, Vol. X, p. 383.

INCORPOREAL HEREDITAMENTS. See REAL ESTATE, Vol. XX, p. 307.

INCUBATION. See BIRDS, Vol. III, p. 775; and INSTINCT, Vol. XIII, p. 158.

INCUNABULA. See BIBLIOGRAPHY, Vol. III, p. 653.

INDEPENDENCE, a city and the capital of Buchanan County, northeastern Iowa, on Wapsipincon River and the Burlington, Cedar Rapids and Northern and the Illinois Central railroads, 65 miles W. of Dubuque. It has the State Hospital for the Insane, erected at a cost of nearly \$1,000,000; three parks, expensive school-buildings, a public library and fair-grounds, and is known for its trotting-horse breeding-farms. Population 1890, 3,163; 1900, 3,656.

INDEPENDENCE, a city and railroad junction and the capital of Montgomery County, southeastern Kansas, located on the Verdigris River, 134 miles, by the Atchison, Topeka and Santa Fé railroad, S. of Lawrence. It is also on the Missouri Pacific railroad, and is the trading and shipping point of a rich corn and vegetable producing section. It has steam grist and planing mills, and has natural gas and a mineral well, valuable for the cure of cutaneous diseases. Population 1900, 4,851.

INDEPENDENCE, a city and the capital of Jackson County, central western Missouri, 10 miles E. of Kansas City and three miles from the Missouri, on the Missouri Pacific railroad. It contains Woodland College (Christian), and Kansas City Ladies' College and several other institutions of learning. It was formerly the headquarters and outfitting depot for the overland routes to New Mexico, Oregon and California. Fruit-growing, apiculture and blooded-horse and cattle breeding are leading industries of the surrounding country. The city has woolen, flour and cider mills, iron and brass foundries and a machine-shop. Pop. 1890, 6,380; 1900, 6,974.

INDETERMINATE EQUATIONS. See ALGEBRA, Vol. I, pp. 554, 555.

INDEX, REFRACTION. See LIGHT, Vol. XIV, p. 590.

INDIA. For general article on this great British empire, giving *in extenso* its geography, history, government, productions, commerce and earlier statistics, see Vol. XII, pp. 731-812. The present area of the empire, without reckoning in Baluchistan (130,000 square miles), which is to some extent dependent on, or feudatory to, India, reaches from lat. 8° N. to lat. 35° N., and from long. 67° E. to long. 100° E. of Greenwich, Cal-

cutta itself lying in long. 88° E. The areas of Kashmir, Manipur, and also of some recently annexed territory, including various dependent Shan states, have never been surveyed. Kashmir, however, is estimated at 80,900 square miles, Manipur at 8,300, and the British Shan states at 90,000. Upper Burma has an area of 83,473 square miles. With these figures the total area of British India may be taken to be 1,559,603 square miles, of which 594,610 square miles are under native, and the remainder under British administration. The population of India, shown by the census in 1891, was 287,123,350. This included the figures for Kashmir, which is allowed a population of 2,543,952, but not Manipur with its population of 221,070, or the Shan states with their estimated population of 400,000, but it includes Upper Burma with its 2,946,933. Adding in these totals, and allowing for a yearly increment of one-half of one per cent to the census figures, the total population of British and feudatory India at the beginning of the year 1899 may be taken to be 308,000,000, of whom 242,000,000 are in British territory. From Peshawar, the northern frontier station, to Cape Comorin, the distance is 1,900 miles, and the same distance separates Karachi, the port of Sind, from Sadiya, the frontier post on the eastern border of Assam. The limit, yet undefined, of the states dependent on Upper Burma stretches even farther to the east than Sadiya, while British influence in Baluchistan goes farther west than Peshawar. The province of Burma, including the country formerly independent, and now called Upper Burma, which was annexed to the Asiatic dominion early in 1886, lies to the east of the Bay of Bengal and forms no part of the Indian Peninsula.

Queen Victoria assumed the government of all the territories of India on September 1, 1858. It was not, however, till Jan. 1, 1877, that she formally assumed the title of Empress of India. The home imperial government is intrusted to a Secretary of State for India, assisted by a council of not less than ten members, the majority of whom must be persons who have served or resided ten years in India, and who have not left India more than ten years previous to the date of their appointment on the council. The office is held for a term of ten years, and any vacancy is filled by the appointment of the Secretary of State for India.

British India proper embraces nine separate provinces, each under its own civil government, but subordinate to the general and supreme government. The resident chief executive, the viceroy and governor-general, whose administration extends over all the provinces, is appointed by the crown. His present annual salary is £20,000 (\$100,000), with additional allowance of about £12,000. His term of office is four years. He is supreme in his executive authority, but is assisted by an executive council of six members, including the commander-in-chief. Power is reserved to him of overruling his council; but all

acts of the government run in the name of the "Governor-General in Council." This body, forming the supreme government in India, passes in review the entire administration in six separate departments—Finance and Commerce, Foreign, Military, Public Works, Home, and the Department of Revenue and Agriculture. Each department is under the charge of a secretary, and is also the special care of a member of the supreme council, who has authority to deal with affairs of routine and minor importance, and to select what is worthy of the consideration of the governor-general and his collective council. The governor-general specially superintends the political business of the foreign office. The Department of Finance and Commerce looks to questions of finance, to stamps, excise, the postoffice, and anything involving a permanent charge on the state; also to questions bearing on the commerce of the country. The most important subjects coming under the attention of the Department of Revenue and Agriculture are the land revenue, forests, and the agricultural development of the country. The Home Department deals with the educational, medical, sanitary, ecclesiastical, judicial, municipal, local government, police and other matters, and has likewise charge of the penal settlements of Port Blair and Nicobar. The Foreign Department conducts relations with Afghanistan, Nepal and other conterminous countries, and corresponds with the political agents of the numerous semi-independent native states of Rajputana and Central India, and with the residents of Mysore, Cashmere, Baroda and Hyderabad. The marine service, as well as the army, is under the Military Department. The legal member takes charge of government bills in the legislative council, which consists of twelve members (besides the seven members of the executive council), of whom one half must be unconnected with the public service. As only Bengal, Madras, Bombay and the Northwest Provinces possess councils of their own, the legislative council of India legislates for those provinces which are unprovided with local councils, or on matters of exceptional importance affecting the empire.

Separate high courts have been established for the provinces of Madras and Bombay and for the lieutenant-governorship of Bengal (with jurisdiction also over Assam), and of the Northwest Provinces. The Punjab has a chief court; the Central Provinces, Oude and Mysore, have each a judicial commissioner, and Burmah has a judicial commissioner and a recorder.

The government of India is debited with the cost of the army for all India, with the interest on debt, and, generally, with all imperial as distinguished from provincial expenditure.

Since the close of the record in Vol. XII, the governors-general have been as follows, with date of appointment: Marquis of Ripon, 1880; Marquis of Dufferin and Ava, 1884; Marquis of Lansdowne, 1888; Earl of Elgin, 1894; Lord Curzon, 1898.

The following table gives the area, the population, and the density of the population per square

mile in the native states of India, according to the census returns of 1891:

NATIVE STATES	SQUARE MILES.	POP. 1891.	DENSITY PER SQ. M.
Hyderabad	82,698	11,537,040	139
Baroda	8,569	2,415,396	294
Mysore	27,936	4,843,523	177
Kashmir	80,000	2,543,952	31
Rajputana	130,268	12,016,162	92
Central India	77,808	10,318,812	133
Bombay	69,045	8,050,298	117
Madras	9,609	3,700,622	385
Central	29,435	2,160,511	73
Bengal	35,834	3,296,379	93
Northwest Provinces	5,109	792,491	155
Punjab	38,299	4,263,280	111
Shan.		2,992	
Total	594,610	65,950,398	111

The names of the principal provinces, with their population, as reported at latest dates, are as follows:

POPULATION OF PROVINCES AND CHIEF CITIES.

PROVINCES	POPULATION IN 1891.	CHIEF CITY.	POP. IN 1891.
Bengal	71,346,987	Calcutta	861,764
Northwest Provinces and Oudh	46,905,085	Allahabad	175,246
		Lucknow	273,028
The Punjab.	20,866,847	Lahore	176,854
Central Provinces.	10,784,294	Nagpur	117,014
Burma (Upper and Lower).	7,605,560	Mandalay	188,815
		Rangoon	180,324
Assam.	5,476,833	Gauhati	10,817
		Sylhet	14,027
Madras.	35,630,440	Madras	452,518
Bombay.	18,901,123	Bombay	821,764
Benar	2,897,491	Ellichpur	36,240

The present Nizam of Hyderabad was installed in 1884. Kashmir was granted to Gholab Sing by Lord Hardinge, after the first Punjab war. His son and successor, Rumbir Sing, died on Sept. 12, 1885, and was succeeded by the present Maharaja, Pertab Sing, when also a British resident was appointed, and stronger pressure was brought to bear in favor of much-needed reforms in the government. In 1889, in consequence of continued misgovernment, the Maharaja was deprived of his powers, which were intrusted to a native council, assisted by the advice of the resident.

The most important recent act of the Indian legislation was a comprehensive act, passed in 1890, dealing with railways in that empire. Other acts dealt with probate and administration in India; with the charge of charitable endowments; with the law relating to guardians and wards; with Indian cantonments; with the forests of Burma; and with tenant-right, land revenue, sanitation and local self-government in the central provinces. All imports are free, excepting arms and ammunition, opium, liquors, petroleum oil and salt.

INDIA, FAMINE IN (1900). To add to the horrors of the plague, which up to the close of 1899 was still virulent in Bombay, India was in 1900

confronted with a direful famine, owing to continuous drought and the failure of the crops. The area affected was of enormous extent, and included the Bengal Presidency and the greater part of the Central Provinces, and from northern Mysore to the Punjab. So calamitous was the scourge that 50 million people were destitute, and in a tract over 300,000 square miles in extent, there was no money to buy grain for the people, save what reached India by the doles of the charitable. In this vast parched area, where the population is in parts 1,000 to the square mile, millions actually died of starvation, while there was hardly a blade of grass or green herb to feed to the cattle. The government of India did what it could in the way of subsidies and in employing millions of the people on irrigation and other relief work. The benevolent among the peoples of the United States and England also did nobly in sending to India both money and food. America, it is stated, contributed a million dollars to the sufferers. Germany also contributed largely. British charity gave \$1,700,000, while the government of India spent \$65,000,000 in relief work. The Viceroy and other British officials also gave freely, while a few of the native princes gave large sums. The squalor, misery, and want were so great, however, that relief, in the mass of instances, was sadly inadequate, and until the rains came, with revived vegetation, the loss of life among the stricken myriads was appalling.

INDIA INK. See INK, Vol. XIII, p. 80.

INDIANA, popularly known as the "Hoosier State," has an area of 35,910 square miles, or 23,264,000 acres. The population, according to the census of 1900, was 2,516,462, giving the state the rank



STATE SEAL OF INDIANA.

of eighth. Within the borders of Indiana the center of population of the United States was located, being at a point a little southwest of Greensburg, the capital of Decatur County, and 20 miles E. of the city of Columbus. During the decade 1880 to 1890, the population of the state increased 10.82 per cent, the number of inhabitants, at the last mentioned date, being 2,192,404. The density of the population was 61.05 to the square mile; 400,566 of the people of the state resided in the 18 cities, constituting 18.27 per cent of the entire population; the relative proportion of males to females was 1,118,347 of the former and 1,074,057 of the latter; 93.33 per cent of the population was native-born, 6.67 per cent only being of foreign birth; there were 45,215 negroes in the state, a gain of 5,987 since 1880.

The surface of Indiana is an undulating plain, sloping toward the southwest; the average annual temperature is about 52° F., and the rainfall is

abundant, being about 42 inches. These conditions are all favorable to agriculture, and the principal products raised in the north central group of states all flourish. The census reports for 1890 gave Indiana the position of fifth in the area of the cereals under cultivation, the amount being 7,341,404 acres, which gave a yield of 178,881,244 bushels, the relative position in production being seventh. The state stood sixth in the area devoted to Indian corn and seventh in the amount produced, the former being 3,586,190 acres and the latter 108,843,094 bushels. In wheat the position occupied was fourth in area, 2,570,017 acres, and fourth in production, 37,318,798 bushels. A good showing was also made in the acreage and production of oats, rye, barley, buckwheat and tobacco, the yield of the last named for the census year being but little short of 8,000,000 pounds. The total number of farms was 198,167, their acreage 20,362,516, their valuation \$754,789,110, the value of implements and machinery \$21,172,255, the live-stock on hand \$93,361,422. The estimated value of the farm products for the year was \$94,759,262. Statistics for 1894 show the total value of the wheat crop to have been \$25,396,310; that of the corn crop, \$38,082,053; and of the crop of oats, \$11,470,806. In addition to the above, about 90,000 acres were devoted to the cultivation of rye, barley, buckwheat and flaxseed, bringing to the producers almost \$1,000,000. The clover hay of the year brought \$8,362,765; the timothy hay, \$11,511,563; Irish potatoes, \$3,539,805; sweet potatoes, \$106,513; and tobacco, \$536,121. The same report shows the number of horses to have been 761,594, of the value of \$38,331,935; mules 57,688, valued at \$3,241,815; milch cows 656,982, valued at \$15,872,685; and other cattle 904,001, of a value of \$18,178,747.

In 1894 the value of all land in the state was \$454,131,203; improvements on these lands, \$86,544,952; city lots, \$149,263,802; improvements thereon, \$153,441,643; personal property, \$291,085,845; telephone and railroad property, \$160,638,070, making the total value of all property subject to taxation, \$1,295,106,515. In 1895 the total receipts of the state from all sources were \$8,525,219.33; the total expenditures aggregated \$8,342,004.20. The state debt, exclusive of the bonds held by state institutions, on January 1, 1898, amounted to \$5,700,615, a reduction of \$1,200,000 having been made during the year preceding. The expenditures for the maintenance of benevolent institutions amounted to \$959,525; for the penal institutions, \$190,484; and for reformatories, \$110,000.

Indiana has made bountiful provision for her dependent and unfortunate citizens, and the institutions for their maintenance and betterment are many and well sustained by ample appropriations. The Central Hospital for the Insane, at Indianapolis, required \$287,000 for the expenses of 1895. The Northern Hospital for the Insane, at Logansport, disbursed the sum of \$105,000 during the same period. The Eastern Hospital for the Insane, at Richmond, which has an average of about 450 patients, expended \$119,973, and the Southern Hospital for the Insane, at Evansville, \$99,984. The

institutions above named all received a portion of the sum required for their maintenance from earnings and contributions levied on counties having citizens among the patients, the aggregate amount of such fund being about \$20,000. The aggregate number of inmates of the four hospitals named ranges from 3,000 to 3,300. The expenses of the Institute for the Deaf and Dumb, located at Indianapolis, were \$70,337; those of the Institute for the Blind, in the same city, \$33,738; for the School for Feeble-minded Youth, at Fort Wayne, \$99,648. A portion of this last-named sum was for the purchase of farm and buildings. The Soldiers' and Sailors' Orphans' Home, at Knightstown, having an enrollment of from 625 to 650 children, required \$107,200. The Reform School for Girls and Women's Prison, at Indianapolis, disbursed \$45,000. The school was opened in 1873, since which time 988 girls had been received up to the close of 1894. The number of girls in attendance for 1895 was about 150, the inmates of the Women's Prison numbering 46. The Reform School for Boys, at Plainfield, with an average of 550 inmates, required \$65,000 for the running expenses of 1895; the State Prison North, at Michigan City, \$105,484; the State Prison South, at Jeffersonville, \$84,999. The two penitentiaries have an average of about 1,500 convicts. In addition to the total number of inmates of the state charitable institutions, there were 2,982 persons at the opening of 1895, who were inmates of county asylums or poorhouses. The causes of their having become dependent on public charity were given as follows: Blind, 131; deaf and dumb, 55; idiotic, 358; insane, 347; old age, 734. The number of inmates of the charitable and penal institutions of the state increased more than 15 per cent from 1890 to 1895,

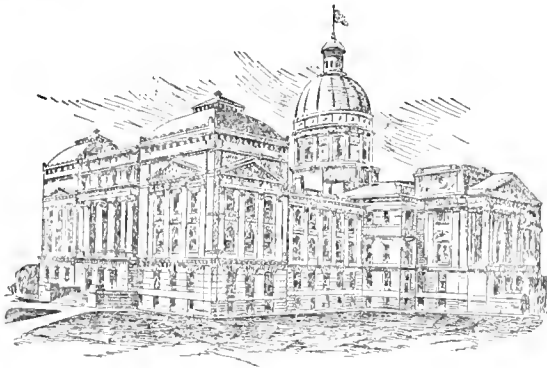

CAPITOL BUILDING, INDIANAPOLIS.

but the cost of maintenance has been decreased greatly, the per-capita expense in 1890 being \$190.68, and \$171.64 in 1895.

During 1895 the amount of money going to the support of the public school was \$1,436,852; the number of children of school age, 808,261. Much state aid is given to institutions of higher education. The Indiana University, at Bloomington, received, in 1895, \$72,200, only \$40,000 of which was required for annual expenses, the remainder going to the purchase of new buildings and interest on bonds. The expenses of the State Normal School were \$20,222, \$10,000 of which went for the pur-

chase of new buildings. This institution had an attendance at the spring term of 1,224, and the graduating class numbered 101, the largest in its history. The Northern Indiana Normal School, at which over 100,000 students have received their education within the 23 years of its existence, had a total attendance of 6,000 in 1895, and the graduating class was the largest ever had, numbering 1,307. The State University had a graduating class of 87, and Wabash College, 28. De Pauw University graduated 65; Butler University, 19; and Purdue University, 76. This latter institution is located at Lafayette, is in its twenty-second year, and disbursed for its annual expenses in 1895 \$128,500, \$21,000 of which came from the government as the annual appropriation for the agricultural college, which is connected. Of the denominational institutions of learning in Indiana, De Pauw University, at Greencastle; Taylor University, at Upland; and Moore's Hill College, at Moore's Hill, are all under the control of the Methodist Episcopal Church. The Lutheran Church controls Concordia College, at Fort Wayne; the Baptist Church, Franklin College, at Franklin; the Presbyterian Church, Hanover College, at Hanover; and the United Brethren, Hartsville College, at Hartsville. The Christian Church has two institutions, one at Irvington, known as Butler College, and one at Merom, known as Union Christian College. The Friends' Church has Earlham College, at Richmond; the Congregationalists, Ridgeville College, at the town of the same name; and the Roman Catholics, St. Meinard's College, at St. Meinard, and the University of Notre Dame, at Notre Dame. The non-sectarian institutions are Indiana University, at Bloomington, and Wabash College, at Crawfordsville.

The census reports of 1890 give the number of manufacturing establishments in the state as 12,354. The leading lines of manufacture were flouring and grist-mill products, \$31,239,627; wholesale slaughtering, \$20,989,039; lumber and other saw-mill products, \$19,964,293; foundry and machine shop products, \$9,542,499; car building, \$14,362,711; carriages and wagons, \$8,248,873. The total amount invested in manufacturing was \$131,605,366; the total number of employees, 124,340; the wages paid, \$51,749,970; and the value of all products, \$226,825,082. Since the date of the compilation of the census figures, large amounts have been invested in manufacturing industries in the gas region. From the time of the discovery of natural gas in 1888 there has been a steady growth of all manufacturing enterprises, requiring large amounts of fuel; and the "gas belt," extending through some twenty-two counties, and covering about six thousand square miles, has attracted capital from all sections of the United States. Reports made at the beginning of 1895 showed that \$300,000,000 had been invested in the various manufactories that had sprung up within the past seven years.

Thirty-one railroads reported to the state officials in 1893, whose total mileage was about 6,000, the earnings \$190,000,000, and the expenses of operation and taxes \$110,000,000.

In 1895 the national banks within the state num-

bered 109, their combined capital \$13,722,000, surplus and profits almost \$7,000,000, and individual deposits of \$38,362,861. There were also 85 state banks and five savings banks, whose combined deposits amounted to about \$13,800,000. The capital of the first-named was \$4,220,000, and the savings banks had 16,127 depositors.

The coal-field of the state is a continuation eastward of the Illinois field, and is known to extend over an area of about 7,000 square miles. It is confined to the western and southwestern portions of the state, and is of the bituminous variety, good for fuel, but worthless for coke or gas. The following report was made of the industry for 1895: Capital invested in the 71 mines reporting, \$1,374,440; amount paid in wages during the year, \$2,473,806; number of tons of coal mined during the year, 3,065,394; total number of employees, 6,663; the average number of days worked, 193.

The gas-fields of Indiana exceed in area those of both Pennsylvania and Ohio, and the oil territory is both extensive and rich. In 1895 and 1896 new wells were being developed almost daily.

Reports made in 1895 showed the building and loan associations of the state to have loaned more than \$12,500,000. The amount of installment stock and credited dividends was \$9,513,487; the paid-up stock and credited dividends, \$3,245,125; the total number of shares of installment stock issued by all associations was 321,831, and of paid-up stock 45,907. The aggregate authorized capital of all was \$94,620,000, of which the sum of \$38,821,220 had been subscribed. The number of shareholders that had borrowed money were 19,176, and the number that had not borrowed were 50,205.

At the beginning of 1899 there were 856 newspapers published in the state, of which number 150 were daily, 2 triweekly, 31 semiweekly, 599 weekly, 1 fortnightly, 9 semimonthly, 62 monthly, and 1 bimonthly. Papers were published in every county and in every county capital of the state.

The following are the chief towns, with official population in 1900: Indianapolis, 169,164; Evansville, 59,007; Fort Wayne, 45,115; Terre Haute, 36,673; New Albany, 20,628; Lafayette, 18,116; South Bend, 35,990; Richmond, 18,226; Logansport, 16,204; Muncie, 20,942; Jeffersonville, 10,774.

The following is a complete list of the governors of the state, with their respective terms of office: Jonathan Jennings, 1816-22; William Hendricks, 1822-25; James B. Ray, 1825-31; Noah Noble, 1831-37; David Wallace, 1837-40; Samuel Bigger, 1840-43; James Whitcomb, 1843-49; Joseph A. Wright, 1849-57; Ashbel P. Willard, 1857-60; Abraham A. Hammond, 1860-61; Oliver P. Morton, 1861-67; Conrad Baker, 1867-73; Thomas A. Hendricks, 1873-77; James D. Williams, 1877-81; Albert G. Porter, 1881-85; Isaac P. Gray, 1885-89; Alvin P. Hovey, 1889-91; Ira J. Chase, 1891-93; Claude Matthews, 1893-97; James A. Mount, 1897. See INDIANA, Vol. XII, pp. 813, 814.

INDIANA, a borough and the capital of Indiana County, western Pennsylvania, 72 miles E.N.E. of Pittsburg, on a branch of the Pennsylvania railroad. It contains a state normal school, planing-mills,

foundries, glass-works, machine-shops, tanneries and a farming-tool factory, and has a large lumber trade. Population 1890, 1,963.

\*INDIAN AFFAIRS IN THE UNITED STATES. (See INDIANS, AMERICAN, Vol. XII, pp. 822-833.) The Indian administration of the United States government is centered in the Department of the Interior. As chief executive of the department, the Secretary of the Interior is *ex officio* at the head of the entire Indian administration. One of the divisions of his office is known as the Division of Indian Affairs, and here a force of clerks is employed in keeping records and in digesting and preparing for consideration those subjects which are referred to the Secretary either directly or through the Commissioner of Indian Affairs, the titular head of the Indian service.

The Commissioner of Indian Affairs is an officer appointed by the President, by and with the advice and consent of the Senate. Although the statutes give him only a general authority over Indian affairs "under the direction of the Secretary of the Interior, and agreeably to such regulations as the President may prescribe," the custom is for the Secretary to consult him on all important questions of policy in his own domain. His immediate jurisdiction is over the Office of Indian Affairs, which is composed of several divisions, such as the division of finance, the division of accounts, the division of lands, etc., each with its force of clerks. He also has the oversight and general control of the Indian field-service, including both agencies and schools; recommends appointments and removals of employees, and himself appoints and removes physicians and licensed traders; he buys and distributes all the food, clothing, farm, school and household utensils, medicines, etc., used for the support and education of the Indians; disburses and accounts for most of the appropriations made by Congress for the Indians and the Indian service, which range from \$8,000,000 to \$10,000,000 or more a year; passes upon the legal questions continually arising out of Indian relations; renders opinions on legislation in process of enactment; issues instructions and directs work pertaining to allotments; approves contracts between Indians and whites, and the like. His conclusions in all cases are subject to review by the Secretary of the Interior. An assistant commissioner, whose tenure of office is the same as the Commissioner's, relieves the Commissioner of a part of his tasks at all times, and exercises the functions of Commissioner in his absence.

Agents, to the number of about sixty, make their homes on the reservations, and represent the government in its ordinary dealings with the Indians under their care. They are of two classes—agents appointed from civil life, and officers of the army detailed by the Secretary of War, at the request of the Secretary of the Interior, for service as acting agents. Civilian agents are appointed by the President, with the consent of the Senate. They give bonds for the faithful performance of their duties, report to the Commissioner, and take orders from him in the ordinary routine of official business.

In cases where the conduct of affairs at any agency



calls for investigation, the Commissioner usually assigns the task of making the inquiry (unless the conditions seem very serious) to one of a staff of five special agents, appointees of the Secretary of the Interior. If the work is intricate, or if the offenses charged are particularly grave, the matter is referred to the Secretary, who has at command a force of five inspectors, appointees of the President, with the consent of the Senate.

The Board of Indian Commissioners consists of ten citizens "eminent for intelligence and philanthropy," chosen from civil life by the President without reference to the Senate, who receive no compensation and who co-operate with the Secretary of the Interior and the Commissioner of Indian Affairs in protecting the Indians from fraud and promoting their civilization. Besides visiting reservations, inquiring into causes of complaint, and supervising the work of the Office of Indian Affairs in letting contracts for supplies, the Board holds two meetings each year for conference with the representatives of missionary societies, Indian schools and the Indian Rights Association. One is held in Washington in the winter, the other in the early fall at Lake Mohonk, New York. At these gatherings reports are made, plans discussed, and memorials prepared for bringing to the attention of the government particular subjects which might otherwise be overlooked as being outside of the general administrative routine. Although the duties of the board are largely advisory, its share in the economy of the Indian administration is important; for on the one hand its recommendations have always had the ear of the President, and on the other hand its expressions of criticism or approval command the confidence of those citizens outside of the public service who are interested in the welfare of the Indians; so that it may be said to serve as a connecting link between the official trustees for the Indians and the public, to whom these trustees must make their ultimate accounting.

At the head of the educational system is a Superintendent of Indian Schools, an appointee of the President. He has nominal control of the whole system, though his authority is exercised subject to the approval of the Commissioner. He is expected to be not only a man of executive capacity, but a skilled educator as well. Under him are three supervisors, appointed by the Secretary of the Interior, who maintain the same relation to the Superintendent that the special agents do to the Commissioner of Indian Affairs. Their work is entirely in the field, where they visit schools, investigate charges of wrongdoing, and report upon the condition of the institutions and the qualifications of superintendents, teachers and lesser employees. The superintendents of the larger schools are bonded officers, and have the direct disbursing of funds. In some cases, where a school is the nucleus of a reservation, its superintendent exercises also the functions of an agent.

The routine work of the Indian service is performed by some 3,500 employees, ranging in rank from clerks and accountants of the highest class down to laborers and servants. In addition to these there is a group of appointees for special and tem-

porary purposes under various acts of Congress, such as commissioners to negotiate with certain tribes, and agents to allot lands, to remove Indians from one point to another, to make treaty payments, to compute damages, etc.

**COST OF THE INDIAN SERVICE.** A fair example of the way in which the money appropriated for the support of the Indian administration is apportioned may be found in the budget for the fiscal year 1896. Here we find devoted to—

Salaries in office of Indian Affairs, and Indian division of Secretary's office-----	\$127,180.00
Current and contingent expenses, including pay of agents and general officers in the field-----	736,190.63
Fulfilling treaty stipulations with Indian tribes-----	2,933,768.44
Gratuitous support of Indian tribes-----	696,759.97
General and miscellaneous expenses-----	287,164.35
Support of schools-----	2,058,507.07
Indian depredation claims-----	200,000.00
Carrying out new agreements-----	15,000.00
Payments from trust funds-----	1,856,909.42
<b>Total-----</b>	<b>\$8,911,479.93</b>

In this table the salaries of the lesser employees in the field are scattered among several items, according to the specific fund out of which each is paid.

**STATISTICS OF INDIAN DISTRIBUTION.** The distribution of the Indian population still under the control of the Federal government, with the number of reservations in each state and territory, the acreage of land occupied by Indians, the acreage cultivated by them, the number of Indians who have adopted citizen's dress and the number who have learned to read, and the number of Indian families who are actually living upon and cultivating lands allotted to them in severalty, are shown in the following table. From this table, and others which follow, the natives of Alaska are omitted. The Alaskans are not under control of the Indian administration, but are cared for by the Federal office of education.

In addition to the Indians shown by this table to have advanced in civilization so far as to discard their savage costumes entirely, about 32,000 have combined some important feature of civilized attire with it. The remainder, a considerable majority, are still in the "blanket" stage, so styled on account of the leading article of outer apparel common to all barbarous Indians.

Anthropologists differ as to whether the Indian race as a whole is decreasing in numbers or slowly dying out. Accurate statistics are difficult to obtain, both on account of the nomadic habits of the Indians and because the treaties and laws under which some of the tribes draw their substance from the government make it profitable for them to conceal deaths and exaggerate the increase of their families. The most trustworthy indications, however, point to an excess of births over deaths, adding perhaps one-fifth of one per cent each year to the Indian population. Most of this increase occurs in the Southwest, where the conditions of life are generally fairly favorable; and the northern tribes which have best held their own are those which

STATES AND TERRITORIES.	NUMBER OF INDIANS.	RESERVATIONS.	ACRES IN RESERVATIONS	ACRES ALLOTTED.	ACRES IN CULTIVATION	FAMILIES CULTIVATING ALLOTMENTS	INDIANS IN CITIZEN'S DRESS.	INDIANS WHO CAN READ.
Arizona	37,723	10	14,098,597	41,623	17,998	70	8,650	1,492
California	13,564	26	432,859	10,220	3,437	135	5,279	534
Colorado	1,144	1	1,094,400		296		53	9
Florida	565				*	<sup>a</sup>	*	125
Idaho	4,198	4	1,896,861	182,270	21,325	240	1,143	570
Indiana	318				*	<sup>a</sup>	*	*
Indian Territory	67,358	12	19,879,573	117,144	630,786	6301	61,388	6885
Iowa	398	1	2,900		600		2	46
Kansas	1,124	5	32,674	30,846	32,992	244	1,084	609
Maine	410				*	<sup>a</sup>	*	*
Michigan	7,428	3	5,944	689,089	*	*	*	*
Minnesota	7,280	10	2,243,753	7,775	14,500	1,200	7,280	1,750
Montana	10,783	6	9,382,400		16,277	30	4,581	2,136
Nebraska	3,889	5	125,817	256,653	24,255	653	2,757	1,868
Nevada	8,537	4	954,135		1,870		1,722	234
New Mexico	9,834	22	1,797,085		6,267	210	347	955
New York	4,935	8	87,677		25,850	15	4,935	2,550
North Carolina	2,893	1	65,211		4,053		2,893	6376
North Dakota	8,134	4	3,812,833	101,407	13,448	458	6,524	1,994
Oklahoma	12,570	13	6,049,715	1,134,207	40,258	1,388	3,226	2,091
Oregon	4,565	5	1,025,931	157,798	10,536	612	2,757	1,425
South Dakota	18,861	7	9,837,299	750,175	27,955	872	11,231	6,759
Texas	290				*	<sup>a</sup>	*	*
Utah	2,160	2	3,972,480		2,590		85	117
Washington	9,334	20	4,046,564	66,859	64,510	969	6,923	2,138
Wisconsin	9,089	7	416,751	169,510	7,987	713	67,879	63,299
Wyoming	1,748	1	1,810,000		760	35	600	450
Totals	249,130	177	84,571,459	3,115,576	368,460	8,145	81,339	32,412

\* No Statistics given.  
<sup>a</sup> Scattered.

<sup>b</sup> Exclusive of five civilized tribes.  
<sup>c</sup> Incomplete.

have not been subject to removal to a very pronounced change of climate.

**THE RESERVATION SYSTEM.** By far the larger part of the Indians in the United States are gathered on reservations. The reservation system had its origin in the difficulty of keeping the peace between the white settlers in the frontier territory and the bands of Indians who roamed about there. The policy was adopted of placing the Indians, in separate groups, on tracts of land from which white trespassers could be excluded, and beyond the limits of which they should not themselves pass except for necessary purposes, and then by special permission.

Reservations as they now exist are of two classes: those established by treaty or act of Congress, and those set apart merely by an executive order. One tribe, for instance, after proving its strength in war, has made a treaty of peace, binding itself to retire to a certain reservation, which shall be its own property thenceforward, and on which it shall live in amity with the government. Another tribe has consented to release a large area of land which it held by right of first possession, and Congress by statute has conferred upon it a smaller area for its home reservation and made up the balance of value in cash, or in interest-bearing Government securities. These are illustrations of the establishment of treaty or statute reservations. Again, where white pioneers have found a tribe of Indians in general possession of a tract of country which invited development, the President, in order to avoid possible friction, has drawn a boundary about that part which seemed to be in most constant use by the Indians, proclaimed it their reservation, and designated an

agent to take charge of it for them; or, the wandering remnants of some almost extinct band of Indians, reduced to a condition of pauperism, have been gathered and given a home upon a parcel of public land set apart by proclamation for the purpose, in the hope, that, by proper instruction and encouragement, they may in time be made self-supporting. These last examples show the origin of the executive-order reservations. Prior to 1887 an essential difference was recognized between such reservations and those created by treaty or statute; the theory being that a mere executive order could vest no title in the Indian occupants of a reservation, and hence that the government might open any part of it to white settlement at will, without paying the Indians for the land thus taken. In that year, however, an allotment law was enacted, which, as construed in a ruling by the Secretary of the Interior, placed an executive-order reservation on substantially the same footing as a reservation created by any other process.\*

**ALLOTMENTS IN SEVERALTY.** Like other nomadic peoples, the Indians have under their own social order no idea of individual ownership of the soil; and to the communistic principle they have clung with great persistence through the four centuries of their contact with white civilization. The obvious necessity of giving the red man a permanent foothold somewhere before he could make any industrial growth, and of cultivating in him the notion of a settled home-life before the moral side of his nature could expand, gave rise to an agitation, some years ago, in favor of a system for allotting lands to

\* The whole subject of Indian land titles, which is too extensive for consideration here, is presented ably in the *Annual Report of the Commissioner of Indian Affairs for 1890*.

Indians in severalty. The agitation culminated in the enactment, in 1887, of the law commonly known as the "Dawes Act" in compliment to its chief champion in Congress, Senator Dawes of Massachusetts. This law, in general terms, empowered the President, in his discretion, to cause any Indian reservation to be surveyed, and the land, or so much as might be necessary, to be divided into parcels of 40, 80 and 160 acres respectively; 160 acres to be allowed to each head of a family, 80 acres to each single person more than eighteen years old and to each orphan under that age, and 40 acres to each other child born before the issue of the President's order directing the allotment; every adult male Indian receiving an allotment of land to be thereby invested with citizenship; the lands thus allotted to be held in trust by the government for the sole use and benefit of the several allottees for twenty-five years, or for a longer period, in the President's discretion, and then conveyed in fee simple, and free of incumbrance, to the allottees or their heirs. The design of these last provisions was to protect an Indian land-owner from the possible bad results of his ignorance and business incapacity, by preventing him from selling or mortgaging his land or loading it with taxes while slowly learning the ways of civilization.

In 1891 the Dawes Act was modified so as to give to each Indian, of any age or sex, eighty acres, making no distinction in favor of heads of families. This amendment resulted from the discovery that under the original law there were frequent instances of injustice to married women. A male Indian who, as the head of a family, had received 160 acres, would divorce his wife after the summary fashion of his race; as the title to the 160 acres was lodged in him, he would retain all this land, or even extend his control to eighty acres more by marrying a single woman who had already an allotment in her own right; while the first wife, through whose union with him he had acquired half of his 160 acres, would become, perhaps by no fault of her own, a homeless pauper.

The land-in-severalty policy was fiercely resisted by two elements among white citizens: that small group of sentimentalists in the East who regard all attempts at the compulsory improvement of the Indian, whether philanthropic or selfish in purpose, as an invasion of his natural rights; and the more numerous class of white farmers in the West who had been able to drive thrifty bargains for grazing cattle and raising crops on the common tribal lands at a nominal yearly rental. The latter class, after the law had reached the statute-book in spite of their resistance, were obliged to lease the lands of the individual allottees; this cost more in rent, because it was necessary to deal with a large number of separate owners instead of making a private arrangement with a few chiefs and head-men. But there was still a rich profit in it till the government, discovering that the ignorant allottees were signing away for a trifle the use of their lands for several years in advance, interfered as trustee and swept aside all leases not officially authorized, declaring them illegal and void. This caused a great commotion among the parties interested. The business

had grown so profitable in some quarters that corporations had been formed to lease Indian lands for a few cents an acre and sub-let them to white farmers for \$1, \$2 or \$2.50 a year. The hardest struggle the government had in breaking up this nefarious traffic was on the lands of the Omahas and Winnebagos, in Nebraska, where test cases were tried in the courts involving all the questions at issue. The decisions were uniformly in favor of the government. An Indian's privilege to lease his land, if he cannot use it advantageously himself, is recognized by law, but this does not limit the discretion vested in the Commissioner of Indian Affairs and the Secretary of the Interior as to disapproving any contract executed by an Indian still under the tutelage of the government.

The policy of allotting lands in severalty has been explained as founded on a hope of making the Indian a fixture somewhere, and of encouraging him to build up a home. It also offers the best practicable means of throwing Indians and whites together in a peaceful relation as neighbors. The Dawes Act confers upon the Secretary of the Interior authority, where an allotment of lands on any reservation is ordered by the President, to negotiate with the Indians for the sale or release of whatever lands may still remain after all the members of the tribe have been provided for. The purpose of this feature of the law is twofold: the money thus acquired, if wisely spent, may be used for improving their farms, supplying needed stock and implements, and otherwise aiding their efforts at self-support; and in any event the opening of the unallotted lands to white settlement is bound to attract to the neighborhood experienced ranchers and herdsmen, from whom the Indians can learn much about practical farming, if they will. It is true that the civilization which these immigrants bring with them is crude, but it is, on the whole, a stepping-stone to something better. Hemmed in on his reservation, the Indian is surrounded only by people of his own race, whose daily companionship is incapable of lifting him out of the condition in which he was born. The handful of Government employees of whom he sees something may be good men, or bad, or indifferent; they certainly are in no sense his permanent neighbors or competitors. On the edge of the reservation, while it remains inclosed, usually gather the worst class of whites, whose only purpose in clustering there is to debauch the Indian and rob him when the government pays money or issues goods to him. So it does not appear that, by having his reservation allotted and opened, and exchanging the environment of a closely watched and guarded ward for that of a free man among men, the Indian is necessarily a moral sufferer.

The whole matter of allotments is still, after nearly ten years of the operation of the Dawes Act, in the experimental stage. The advocates of that law had intended to have it applied at first to one or two tribes which seemed to be in the right condition for a test, and, if it proved successful with them, to extend its operation gradually and carefully through the Indian country. But at about the time of its enactment a land mania seemed to seize the

American people, and unremitting pressure was brought to bear upon the administration at Washington for the opening of new country to settlement. Before the next session of Congress began, seven reservations were in process of allotment. A check was then applied by the President; but the work of rapid allotment was resumed under his successor in office two years later, and has been going on more or less rapidly ever since, with varying results. In individual instances the system has worked well, without doubt, but there are still a number of vexatious problems to be solved in connection with it. One of these is the liquor question.

**THE LIQUOR QUESTION.** The law against introducing intoxicants into "the Indian country," and against selling or giving them to "any Indian under the charge of an Indian superintendent or agent," makes the offense punishable by imprisonment for not more than two years, and by a fine of not more than \$300. Any superintendent, agent, sub-agent or commander of a military post is authorized to search the property of a suspected person, who, if intoxicants are found in his possession, must suffer forfeiture of all his belongings; and if the offender be a licensed trader, his license must be revoked and his bond put to suit.

The interpretation of these statutes has never proved difficult, except as to some minor technical details; but with the transition of an Indian from the exclusive control of the Federal government on a reservation to citizenship, in the midst of a different social order, the question has arisen whether the laws against the liquor traffic in "the Indian country" are any longer applicable to his case, and, indeed, whether a person who sells liquor to him anywhere does not enjoy the same immunity as one who sells to a white citizen. The Commissioner of Indian Affairs has insisted steadily that the government's tenure of an Indian's allotted land, in trust for 25 years, involves also such control of the allottee that he is, for the purpose of the liquor law, still under charge of the resident agent. But the decisions of the courts on this point are so conflicting that the Commissioner has urged the enactment of new and unequivocal legislation, forbidding the sale or gift of intoxicants "to any Indian to whom allotment of land has been made while the title to the same shall be held in trust by the government, . . . or any Indian, including mixed bloods, over whom the government, through its departments, exercises guardianship."

**JUDICIARY AND POLICE.** The preservation of good order on a reservation several hundred square miles in area, containing some thousands of Indians and only a handful of white government employes, presents not a few difficulties. It is impracticable to treat the reservation Indian as amenable to all the laws of civilized white society, and to try him in the United States courts for such misdemeanors as theft, destruction of property, drunkenness, licentiousness, etc. On the other hand, to clothe the agent or superintendent with despotic powers as a magistrate fails to educate the Indian to that understanding of and respect for the machinery of organized justice which must be his first

lesson in citizenship. Accordingly, in 1883, the Office of Indian Affairs established in several of the more important reservations a Court of Indian Offenses. This tribunal consisted of three Indian judges, nominated by the agent, and appointed by the Commissioner for a term of one year, but subject to instant removal for misconduct. The aim of every good agent was to select for judges the wisest, cleverest and most generally esteemed chiefs who could be induced to serve, and their sittings were surrounded with as much solemnity and dignity as possible. For five years this system of courts was sustained without cost to the Government, the judges serving gratuitously or being remunerated from the fines collected. Then Congress recognized its existence by a small appropriation for its support, which later was increased and has since been repeated regularly in the annual budget. The judgeships, however, even with a small salary attached, have not been much sought, because of the unpopularity suffered by any Indian magistrate who did his full duty in punishing the wrong acts of his fellow-tribesmen. They fell into still further disfavor with the progress of the allotment system; for the cases involving citizen Indians began to be carried into the neighboring state and territorial courts, which regularly ignored or overturned the decrees of the Indian courts. The latter still are maintained where the local conditions are not too unfavorable, but as a whole they are on the decline.

The judgments of these courts are enforced, and the orders of the agents everywhere executed, by a body of Indian police. Each reservation has its separate troop, and the larger troops are officered by captains, lieutenants and sergeants. The number on each reservation varies, and is governed by the area to be patrolled, the size, character and occupations of the tribe concerned, and like considerations. The whole number of police, including officers, is 895. The largest single forces are found in Indian Territory and Oklahoma, and on the various Sioux reservations in North and South Dakota, where they range from 26 to 43. On some small and peaceable reservations one captain and four privates do all the work. A private is paid \$10 a month, and an officer \$15, and the places are usually in demand, so that an agent, who is both conscientious and tactful, is able, by a judicious use of his recommendations for appointment, promotion and dismissal, to command the services of some of the best Indians on his reservation to help him keep order and administer discipline.

The active service of a policeman, being mostly performed in the open air and on horseback, and in a uniform of blue cloth with brass buttons, offers more attractions to the Indian taste than that of a judge, which is somewhat confining and lacks variety. The Indian police help the agent hunt down violators of the liquor laws; arrest intruders on the reservation; suppress violence among members of the tribe; collect and report data about births and deaths; carry the summons when it is necessary to hold a council, and make themselves generally useful about the agency. They also, on several occa-

sions, have proved their loyalty by heroic service for the government when their own people were in revolt.

**THE SCHOOL SYSTEM.** The school system came into being when, after years of wasteful warfare, the government concluded that to educate the Indians would be more practical, as well as more humane, than to kill them. Religious and philanthropic corporations established schools for Indian children at various points on the frontier of civilization, and with these the government entered into contract for the care of a certain number of pupils each year at a uniform rate for each pupil. They are known technically as "contract schools," but "sectarian schools" has come to be their popular designation, owing to the fact that the religious instruction imparted in most of them is according to the tenets of some one denomination. The government also has established a number of schools of its own, in which the teaching is in the main secular, though a few of the elementary principles common to all phases of the Christian religion give tone to the instruction in morals and manners. About the year 1890, the government, in pursuance of a policy mapped out by Commissioner Morgan, began to strengthen its own school system with a view to the gradual substitution of government schools for contract schools till the whole educational establishment should be brought absolutely under government control. In this movement the religious organizations generally have co-operated. In some instances they have turned their schools over bodily to the government; in others they have arranged for the sale of certain buildings and apparatus. Many of the teachers have been transferred by mutual consent from the pay-rolls of the missionary societies to those of the government. In 1895 Congress sanctioned the change, by providing in the general appropriation bill for the gradual shrinkage of the contract system at the rate of twenty per cent yearly, with a view to its entire extinction with the close of the nineteenth century. The following table shows the amounts set apart for the education of Indians in schools under private control for the fiscal year 1890, which marks the point at which the Office of Indian Affairs entered upon its new policy, and for the fiscal year 1896, the first one in which this policy was recognized by Congress in appropriate legislation:

	1890.	1896.
Roman Catholic.....	\$356,957	\$308,471
Presbyterian.....	47,650	-----
Congregational.....	28,459	-----
Protestant Episcopal.....	24,876	2,160
Friends.....	23,383	-----
Mennonite.....	4,375	3,125
Unitarian.....	5,400	-----
Lutheran.....	7,560	-----
Methodist.....	9,940	600
Miss Grace Howard*.....	600	3,000
Lincoln Institute*.....	33,400	33,400
Hampton Institute*.....	20,040	20,040
Totals.....	\$562,640	\$370,796

\*Unsectarian.

The difference between these totals is the joint product of the changes in the contract system made by the Office of Indian Affairs in its own discretion—which between 1890 and 1895 effected a reduction of nearly one hundred thousand dollars—and by the twenty-per-cent scale sanctioned by Congress for the fiscal year 1896. It will be observed that the distribution of the reduced appropriations followed no hard and fast lines, but was made according to the needs of the service. The general appropriation bill for the fiscal year 1897, as it passed the House of Representatives, contained no provision for the contract schools under sectarian control, the House voting to withdraw their government support at once instead of continuing the policy of gradual extinction. The omission gave rise to extended debate in the Senate, ending with the passage of a greatly reduced appropriation and a proviso that all contracts with sectarian schools should cease on or before July 1, 1898. This compromise was suggested by the fact that the managers of those schools, who had made their preparations with reference to the continuance of the sliding scale of reduction, would suffer injustice by a sudden change of programme, while the government schools, even if filled to their utmost capacity, would leave about one thousand pupils unaccommodated.

The government schools are divided into three classes: Day-schools, on or adjoining reservations, numbering 110, with a total capacity for 4,145 and an average attendance of 2,528 pupils; boarding-schools, on the reservations, numbering 75, with a total capacity for 7,845 and an average attendance of 6,477; and training-schools, not on the reservations, known briefly as "non-reservation" schools. Of this last class the following table shows the locations, dates of establishment, capacity and average attendance during the fiscal year 1895:

	OPENED.	CAPACITY.	ATTEND- ANCE.
Albuquerque, New Mexico.....	1884	500	499
Carson, Nevada.....	1890	135	119
Carlisle, Pennsylvania.....	1879	800	668
Chemawa, Oregon.....	1880	300	214
Chillico, Oklahoma.....	1884	400	339
Flandreau, South Dakota.....	1893	175	112
Fort Lewis, Colorado.....	1892	300	151
Fort Mojave, Arizona.....	1890	150	151
Fort Shaw, Montana.....	1892	250	194
Genoa, Nebraska.....	1884	350	192
Grand Junction, Colorado.....	1886	150	117
Lawrence, Kansas*.....	1884	500	499
Mount Pleasant, Michigan.....	1893	160	135
Perris, California.....	1893	125	107
Phoenix, Arizona.....	1891	150	137
Pierre, South Dakota.....	1891	180	104
Pipestone, Minnesota.....	1893	90	58
Santa Fé, New Mexico.....	1890	150	133
Tomah, Wisconsin.....	1893	125	80
Totals.....	-----	4,990	3,779

The schools considered under this title do not include those of the Five Civilized Tribes in Indian Territory, which are under the jurisdiction of the tribal governments, or those in New York, for which the state has undertaken to provide.

\*Haskell Institute.

The total average attendance at the government schools is, as we have seen, 1,976 short of their capacity, the greatest disparity showing itself in the day-schools, where the children are under home influences, which often interfere with their regularity of attendance. The contract schools had an average attendance, during the fiscal year 1895, of 4,998; and 192 Indian children, living near public day-schools supported by state and territorial taxation, attended those by special arrangement between the Federal government and the local authorities, while 194 attended mission schools not assisted by the government. This gives us a grand average of 18,188 Indian pupils actually attending school, or about one half of the school population under the jurisdiction of the Office of Indian Affairs.

Great diversity of opinion exists among Indian educators whether the reservation or the non-reservation school is the more fruitful of good. The truth is that each meets a need which the other could not. There are many Indian parents who will not permit their children to leave them for a considerable period, or make a long journey from home; but the children ought not, on that account, to be deprived of an education. The pupils at the reservation boarding-schools can be visited by their parents from time to time, and spend their vacations at home; and those at the day-schools are continually under the eyes of their parents. Although these conditions are not usually conducive to the best advancement of the pupils, they have their compensation in the fact that the children carry some of the moral atmosphere of the school home with them to the advantage of the elders. On the other hand, the young Indians who attend the non-reservation schools make more rapid progress, because they are wholly divorced for a while from the degrading influences of the camp and lodge, and learn from their surroundings to appreciate the higher civilization; but when, after an absence of some years and a course of careful training for mind and hand, they return to their home reservations, their situation is most trying. They are out of sympathy with the tribal life and institutions. The Indians who have remained in barbarism are jealous, suspicious and often vengeful in their attitude toward the returned students; and the latter, if once overcome by the old influences, relapse into a state much worse than that from which they first emerged. The duty of the government to these young people is plain. They should go back, if at all, clothed with some outward dignity which will compel the respect of the tribe. They should be commissioned as employees of the government, as teachers, farmers, blacksmiths, or the like. The spectacle of these young men and women returning from their schools with some insignia of authority, and with a monthly salary, however small, coming to them as the fruit of their labor, would impress the conservative element with more of a sense of the benefits of an education than any amount of abstract argument. The wisdom of such a policy is beginning to be understood at Washington. In selecting the minor employees at the agencies and in the schools, the preference now is given uniform-

ly to educated Indians over whites of like capacity.

An admirable feature of the course of instruction at the Carlisle School, which has been followed successfully at some other non-reservation schools, is the "outing system." This consists in finding employment in the neighborhood, as farm-hands, cooks, dairy-workers, etc., for those pupils of both sexes who can be trusted to fill them acceptably during the long vacations. The young Indians thus are enabled to apply practically the industrial lessons they have learned at school, while their introduction to civilized home-life among the white people of the denser communities of the East aids greatly in their moral development.

Three subjects have occupied largely the attention of the superintendent of Indian schools, Dr. W. N. Hailmann. One is the inner work of the schools; that is, the special adaptation of the methods of instruction to the minds of children who are acquiring the rudiments of an education in a civilization and a language utterly foreign to those of their ancestors. The second is the combination of industrial with scholastic work, so as to make each of the two elements promote the progress of the other. The third is the cultivation of a distinct *esprit de corps* among the superintendents, teachers and school employees, by the encouragement of frequent conferences and discussions, so that each member of the educational staff, from the highest to the humblest, shall feel not only that his own work is of practical importance in itself, but that its greatest usefulness will be assured by maintaining its proper relation to the work of all the others.

Dr. Hailmann is engaged now in an effort to supplement the changes which land-ownership and citizenship have wrought in the status of the Indians, by making gradual provision for the absorption of Indian children into the general school population of the several states and territories in which they live. Wherever it is impracticable to place these children in the common schools of their own neighborhoods, side by side with the white children, he is endeavoring to induce the state authorities to establish separate schools for the children of Indian allottees. The commonest objection raised by the local authorities is, that as long as the land of the Indians is absolved from taxation, the burden of educating both races falls unfairly upon the white taxpayers; this he meets with the proposal that the Federal government shall pay a proportional share of the expense out of the income of the funds which it holds in trust for the benefit of the various tribes. The idea which he is endeavoring to impress upon the state governments is, that since the Indians are being transformed rapidly from irresponsible wards into responsible citizens, any state whose population is absorbing them ministers directly to its own interest in aiding their rapid civilization and education. His efforts have already met a hearty response in Washington, Oregon, California, Nevada, Minnesota, Wisconsin and Iowa, and in others the matter has been taken under advisement.

FIELD MATRONS. A very important adjunct to the day-school on a reservation is the work of the

field matron. Her duty is to instruct Indian women in the arts of housekeeping and home-making. She visits them in their camps, tries to win their confidence and affection, and acts as their adviser and helper in all matters of domestic management. For such duties it is desirable to have a woman without close family ties that are liable to distract her attention; unmarried women of experience and judgment, or widows without living children, are oftenest chosen. The lessons of morality, neatness and method, which the children of a family learn at school, are carried home and doubtless form the subject of more or less discussion with the mother. If her attitude toward all this is indifferent or contemptuous, the influence of the teacher with the child receives a serious check. If, on the other hand, the field matron has succeeded in arousing the mother's interest, the teacher's work is not only supplemented as far as the child is concerned, but its general effectiveness is increased, and a whole camp feels its indirect effects. It is a striking illustration of the government's lack of a definite policy in dealing with Indian affairs, that Congress, while appropriating liberal sums for the instruction of adult male Indians in farming, has provided only a pittance, and that grudgingly, for the instruction of the women in their duties as wives and mothers. Hence, on many of the reservations the head of the family and his children of school age spend their working day in an atmosphere of modern civilization and thrift, only to return in the evening to the squalor and barbarism of a tepee kept by a woman still almost as savage as her ancestors four centuries ago.

**CIVIL-SERVICE REFORM.** Until the year 1891, the Indian service had suffered seriously from the lack of a consistent system governing appointments to any of its branches. With the exception of the clerical force in the Office of Indian Affairs in Washington, who were subject to the civil-service law of 1883 as part of the Departmental service, changes of officers and employees were made with each change of political control of the government at Washington, regardless of the fitness of the persons dismissed or appointed, but with a view simply to finding salaried positions for members of the dominant party and their dependent relatives and friends. In 1891 President Harrison issued an order extending the civil-service rules over 703 positions, including those of physicians at both agencies and schools, and of superintendents, assistant superintendents, teachers and matrons in the school service. In 1896 President Cleveland made a further extension of the rules, covering the places of clerk, assistant clerk, issue clerk, property clerk, storekeeper and all other clerical positions at Indian agencies and Indian schools, and of supervisor, day-school inspector, disciplinarian, industrial teacher, teacher of industries, kindergarten teacher, farmer, nurse, assistant matron and seamstress at the schools. Soon afterward the same President ordered a complete revision of the civil-service rules, which added all the other minor places to this list, as far as practicable.

Secretary of the Interior, Hoke Smith, became so impressed, during the first two years of his

administration, with the evil effects of allowing the Indian service to be made the sport of politics, that, in his annual report for 1895, he outlined a policy which attracted wide attention, and which the friends of the service now are using their best endeavors to have embodied in legislation. Besides the extension of the civil-service rules to all the subordinate places to which they could properly be applied, he recommended:

1. That instead of a single commissioner of Indian affairs, there be a board of three commissioners, two of them to be civilians, appointed from different political parties, and the third a detailed army officer.

2. That the tenure of office of an Indian agent be conditioned alone upon the faithful discharge of his duties, and that appointments and removals be made by the President on the recommendation of the three commissioners.

Up to the present time Congress has taken no steps looking to the execution of this programme.

INDIAN AGENCIES.	AREA IN SQUARE MILES.	POPULATION.
Blackfeet, Montana-----	2,750	2,293
Cheyenne River, South Dakota-----	2,451	2,846
Cheyenne and Arapahoe, Oklahoma-----	6,715	3,598
Colorado River, Arizona-----	530	979
Colville Agency, Washington-----	5,348	2,301
Crow Creek and Lower Brulé, S. Dak.	1,185	2,171
Crow, Montana-----	7,394	2,456
Devil's Lake, North Dakota-----	432	2,356
Eastern Cherokee, North Carolina-----	102	3,000
Flathead, Montana-----	2,240	1,914
Fort Berthold, North Dakota-----	4,550	1,195
Fort Belknap, Montana-----	840	1,793
Fort Hall, Idaho-----	1,878	1,600
Fort Peck, Montana-----	2,775	1,891
Grand Ronde, Oregon-----	96	374
Green Bay, Wisconsin-----	483	3,350
Hoop Valley, California-----	180	476
Kiowa, Oklahoma-----	5,801	4,088
Klamath, Oregon-----	1,650	994
Lemhi, Idaho-----	100	524
La Pointe, Wisconsin-----	667	4,713
Mescalero, New Mexico-----	741	474
Mission Tule River (consolidated), Cal.	432	4,524
Navajo, New Mexico-----	16,741	20,200
Neah Bay, Washington-----	36	736
Nevada, Nevada-----	1,001	959
New York, New York-----	137	5,046
Nez Percés, Idaho-----	1,167	1,450
Omaha and Winnebago, Nebraska-----	124	2,347
Osage and Kaw, Oklahoma-----	2,453	1,690
Pima, Arizona-----	775	11,518
Pine Ridge, South Dakota-----	4,930	5,011
Ponca, Pawnee, Otoe and Oakland, Ok.	803	1,865
Pottawatomie and Great Nemaha, Kan.	190	959
Pueblo, New Mexico-----	1,417	8,252
Puyallup (consolidated), Washington	364	1,844
Quapaw, Indian Territory-----	325	1,150
Roune Valley, California-----	159	531
Rosebud, South Dakota-----	5,044	7,586
San Carlos, Arizona-----	3,950	3,940
Southern Ute and Jicarilla, Colorado	2,360	1,814
Sisseton, South Dakota-----	1,235	1,487
Standing Rock, North Dakota-----	4,176	4,110
Sac and Fox, Oklahoma-----	2,329	2,180
Sac and Fox, Iowa-----	2	393
Santee, Nebraska-----	150	1,354
Shoshone, Wyoming-----	1,235	1,945
Siletz, Oregon-----	351	666
Tongue River, Montana-----	580	867
Tulalip, Washington-----	25	1,283

INDIAN AGENCIES.	AREA IN SQUARE MILES.	POPULATION.
Umatilla, Oregon.....	420	983
Union, Indian Territory.....	30,914	65,200
Uintah and Ouray, Utah.....	6,207	1,904
Warm Springs, Oregon.....	725	853
White Earth, Minnesota.....	6,988	6,239
Western Shoshone, Nevada.....	488	477
Yakama, Washington.....	1,250	1,675
Yankton, South Dakota.....	672	1,700

FRANCIS E. LEUPP.

INDIAN ANTIQUITIES. See AMERICA, Vol. I, pp. 692-694.

INDIANAPOLIS, a city of central Indiana and the state capital. (See INDIANAPOLIS, Vol. XII, pp. 814, 815.) It is in the great corn belt of the West, near its center, and in the natural-gas region of Indiana. It has many grain-elevators, flouring-mills and pork-packing establishments, extensive rolling-mills, malleable-iron works, carriage-shops, foundries and machine-shops, manufacturing of agricultural implements, glass, organs, railroad cars, sewing-machines, pianos, cotton goods, woolen goods, sashes, blinds and furniture. The manufacturing establishments of the city have an aggregate capital of \$15,000,000, and produce \$32,000,000 worth of merchandise annually. They employ on the average 16,000 hands. The stock-yards cover an area of over 100 acres, and receive annually over 1,000,000 head of stock. Indianapolis has numerous public schools and many medical and other professional colleges. The clearing-house does an annual business of \$215,000,000. The city has an excellent fire department, the Holly system of water-works, electric and gas lights, and a system of electric street-railways. In 1890 the assessed valuation was \$99,125,695; tax rate, \$15 per \$1,000; municipal debt, \$1,384,500. Population 1890, 105,436; 1900, 160,161.

INDIANA UNIVERSITY, a state institution for collegiate education, founded in 1820, and

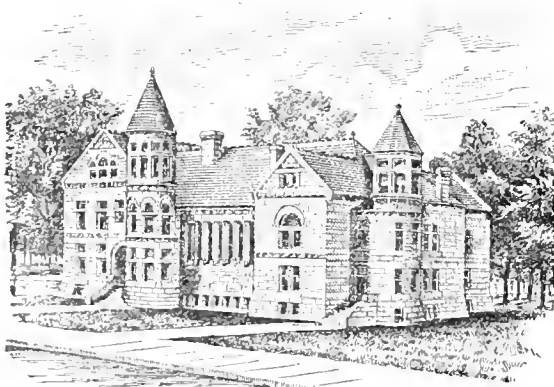

INDIANA UNIVERSITY.

non-sectarian. It occupies a fine set of buildings in Bloomington, the county-seat of Monroe County, Indiana; it is opened to both sexes, and counts (1898) 60 professors and instructors, 1,049 students, and a library of 30,000 volumes. Since

its organization 2,022 students were graduated from this university.

INDIAN CALENDAR. See AMERICA, Vol. I, p. 695.

INDIAN CIVILIZATION. See AMERICA, Vol. I, pp. 694-700.

INDIAN CORN OR MAIZE. See MAIZE, Vol. XV, pp. 309, 310; and AGRICULTURE, in these Supplements.

INDIAN HEMP OR CANNABIS. See BHANG, Vol. III, p. 627.

INDIAN LANGUAGES. See AMERICA, Vol. I, pp. 688, 689; and INDIANS, Vol. XII, pp. 823, 824.

INDIANOLA, a city and the capital of Warren County, Iowa; located 20 miles S. of Des Moines, on the Chicago, Burlington and Quincy and the Chicago, Rock Island and Pacific railroads. It manufactures farm implements, bricks, tiles and earthenware; and ships corn, wheat, oats, butter and other farm produce. It is the seat of Simpson (Methodist) College, which has 14 instructors and 451 students. Population 1890, 2,254; 1900, 3,261.

INDIAN RIVER, a narrow tidal channel parallel with the Atlantic coast, and lying in Brevard and Volusia Counties, Florida. It is 82 miles long, and finds an outlet to the ocean at Indian Inlet. It is navigable for boats drawing not more than five feet, and as the climate of the locality is healthful, and fish abound in the river, it is a resort for invalids and sportsmen.

INDIAN SHOT. See CANNA, in these Supplements.

INDIAN SUMMER, in the United States a period of late autumn characterized by calm, dry, and hazy weather, particularly noticeable in the upper Mississippi Valley, although extending east to the Atlantic States. The haze is due to very fine dust and thin smoke which float close to the surface of the earth in the still atmosphere. The name is due to the fact that this condition was first observed in the central region chiefly occupied by Indians at the time the term was introduced.

INDIAN TERRITORY now comprises the only unorganized territory of the United States. It was originally set aside as a permanent home for the Indian tribes who had occupied reservations east of the Mississippi River, and upon their removal the government of the inhabitants was placed in the hands of the different tribes, who selected legislatures, followed old tribal customs and had their chiefs, mingling the usages of civilized countries with their own ideas of government. The territory was placed under the supervision of the Bureau of Indian Affairs, of the Department of the Interior, and remains under the direct management of that bureau.

By the act of Congress, approved by the President May 2, 1890, creating Oklahoma Territory, the boundaries of the former Indian Territory were changed, and the new Indian territory was defined to comprise "all that part of the United States which is bounded on the north by the state



of Kansas, on the east by the states of Arkansas and Missouri, on the south by the state of Texas, and on the west and north by the territory of Oklahoma.”



CHEROKEE NATION SEAL.

On September 16, 1893, the Cherokee Strip, comprising 6,000,000 acres of the north part of the territory, was opened for settlement. The eastern part of the strip was fertile, and was traversed by a railway, in addition to being well

watered. Ninety thousand people gathered at the boundary-line to compete for claims when the signal-gun should be fired at noon of the day set for the opening. Every available claim was taken the first day, and thousands were disappointed in securing any land. The middle section of the tract was arid and not at all desirable. In 1892 the reservations assigned to the Cheyennes and Arapahoes, containing 6,500 square miles, were acquired by the government and thrown open for settlement. The tribes now remaining in the territory and holding lands are as follow:

NATIONS.	AREA.	POPULATION.
Choctaw .....	10,450	42,645
Cherokee .....	7,861	56,775
Chickasaw .....	7,267	57,793
Creek .....	5,024	17,912
Seminole .....	312½	2,657

Attempts were made in 1892-93 to secure the passage of a law in Congress looking to the admission of Indian Territory as a state of the Union. The act failed of passage, and in 1894 again was defeated.

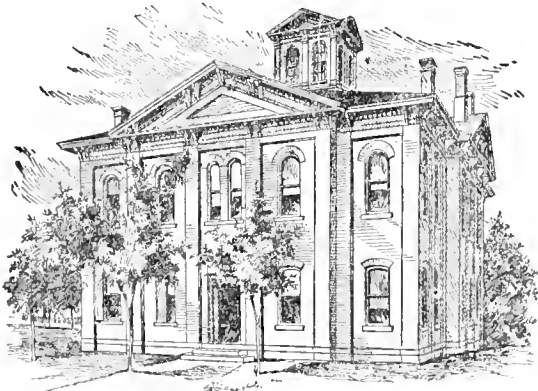

CAPITOL BUILDING, TAHLEQUAH.

The population is a mixed one. The laws of all the five nations allow negroes to become citizens, and white men marrying Indian women are counted as citizens and may hold property. By the census of 1900 the following were shown to be the constituents of the population: Indians, chiefly Cherokees, Chickasaws, Choctaws, and Creeks, making, with some whites, a total of 391,960.

In the eastern part of the territory agriculture is carried on to a large extent, the principal crops and their yields for 1890 being as follows: Corn, 3,724,000 bushels; wheat, 1,48,980 bushels; oats, 204,684 bushels; potatoes, 54,600 bushels; sweet potatoes, 47,900 bushels. Cotton thrives well, and the yield is estimated at about 24,000 bales annually. The live-stock numbered more than 1,000,000 head at the time of the taking of the decennial census, comprising some 75,000 horses, 35,000 sheep, 300,000 head of hogs and more than 500,000 head of other cattle.

The census reports of 1890 show 20 specified manufacturing industries, in which \$204,429 was invested; 175 employees, who received \$79,830 in wages; materials used were valued at \$127,864, and the finished products yielded a return of \$248,932. The principal industry was that of lumber and other mill products from logs or bolts. Other enterprises were flour and grist mills, cotton-ginning, manufacture of brick and tile, and the printing and publishing of newspapers and periodicals.

The principal towns all have banks, there being six national and three private banks in the territory. The principal business of the Indian population is agriculture, stock-raising and wool-growing, the small amount of mining that is carried on being done principally by the whites who have become members of the tribes.

The government holds a little in excess of \$8,000,000 for the five nations, on which almost \$500,000 is annually paid as interest. This interest fund is expended under the direction of the different nations and their councils.

There are more than 600 church organizations in the Territory, with almost an equal number of houses of worship. The Methodist Episcopal South is the strongest organization, having 275 congregations, about 10,000 members, and property valued at \$60,000. The Baptist South is the next in importance, having about the same number of members, but lacking about one hundred of the number of congregations and having but \$35,000 worth of church property. Other denominations represented are the Disciples, Presbyterians in the United States of America, Roman Catholic, Cumberland Presbyterians, Methodist Episcopal and the Church of God.

The tribes all support schools abundantly. The entire number of primary and high-schools, seminaries and academies number about three hundred and fifty, in addition to which there are several denominational institutions supported by the churches, and three orphan asylums.

The Postmaster-General reported 498 post offices, June 30, 1898, at which time there were 6 daily papers, 77 weekly, 1 semimonthly, and 1 monthly; total, 85.

Muscogee is the chief commercial center of the territory, and is the seat of the United States court. McAlester and South McAlester, in the Cherokee Nation, have a combined population of about 15,000 (1896). The main supply of coal for the territory is obtained here, and the industry

is one of large dimensions and annually increasing. Okmulgee, capital of the Creek Nation; Tahlequah, capital of the Cherokee Nation; Atoka, capital of the Choctaw Nation; Tishomingo, capital of the Chickasaw Nation; We-woka, capital of the Seminole Nation, are all considerable places and constantly growing. See also INDIAN TERRITORY, Vol. XII, pp. 833-35.

INDIAN TOBACCO. See LOBELIA, Vol. XIV, p. 743.

INDIAN UNIVERSITY, an institution for the training of Indians as teachers and evangelists among their own people; near Muscogee, Indian Territory; was founded in 1880 by Professor A. C. Bacone, its first president; under control of the American Home Baptist Missionary Society; established since 1885 in its own commodious quarters, at a cost of thirty thousand dollars.

INDICAN. See INDIGO, Vol. XII, p. 843.

INDIGIRKA, a river of eastern Siberia, in the government of Jakutsk. It rises in the Yablonoi Mountains, flows north for about 750 miles, through deserts and frozen marshes, falling into the Arctic Ocean in lat.  $71^{\circ}$  N. and long.  $150^{\circ}$  E. The surrounding region is very thinly populated, and the few inhabitants live entirely by hunting.

INDIGO BIRD. See NONPAREIL, Vol. XVII, p. 534.

INDIGOTINE. See INDIGO, Vol. XII, pp. 843, 844.

INDIVIDUALITY. See BIOLOGY, Vol. III, p. 688.

INDO-CHINA. See COCHIN-CHINA, Vol. VI, pp. 92-97.

INDO-EUROPEAN OR INDO-GERMANIC LANGUAGES. See PHILOLOGY, Vol. XVIII, pp. 784-790.

INDRA. See BRAHMANISM, Vol. IV, p. 202; and MYTHOLOGY, Vol. XVII, p. 153.

INDRE RIVER. See LOIRE, Vol. XIV, pp. 806, 807.

INDUCED CURRENT, VALUE OF. See ELECTRICITY, § 73 in these Supplements.

INDUCTION. See LOGIC, Vol. XIV, pp. 789, 790.

INDUCTION, A POSTERIORI PROCESS. See METAPHYSIC, Vol. XVI, pp. 97-99.

INDUCTION, ELECTRO-MAGNETIC. See MAGNETISM, Vol. XV, pp. 223, 240, 250; and ELECTRICITY, p. 1152, in these Supplements.

INDUCTION, IN STRONGLY MAGNETIC BODIES. See MAGNETISM, Vol. XV, pp. 250, 261.

INDUCTION, MATHEMATICAL THEORY OF MAGNETIC. See MAGNETISM, Vol. XV, pp. 243-250.

INDUCTION COIL. See ELECTRICITY, Vol. VIII, p. 103; and ELECTRICITY, § 74 in these Supplements.

INDUCTIVE CAPACITY. See ELECTRICITY, § 36 in these Supplements.

INDUSIAL LIMESTONE, a variety of freshwater limestone, found in Auvergne, France, and some other localities, formed of the cases (indusæ) of caddice-worms—the larvæ of *Phryganea*—great heaps of which have been incrustated with

carbonate of lime, and formed into a hard travertine.

\*INDUSTRIAL CONDITION OF WOMEN. Mrs. Fanny Purdy Palmer, of Providence, Rhode Island, one of the factory inspectors of that state, delivered an address before the ninth annual convention of the International Association of Factory Inspectors, in September of 1895, in which she said: "At a low estimate there are at present about four million women engaged in paid industries in the United States, about 18 per cent of the entire female population of 10 years of age and upward. In 1870 there were 1,836,288 women in gainful occupations; in 1890 there were 3,914,711, the number having more than doubled in twenty years." Mr. Carroll D. Wright, in his study of working-women in the large cities, made in 1888, instances 340 occupations in which women are employed. The United States census of 1890 shows that out of 219 specified occupations, women are employed in 217. It is estimated that there are 400,000 women typewriters, bookkeepers and accountants in 1890, against 8,000 in 1870; one third the number of school-teachers in 1870 that were found in 1890; and the census of 1890 records for the first time women architects, surveyors, assayers, engineers, and even two veterinary surgeons. The average age of the four million women who have been tabulated as engaged in occupations is twenty-four years. Observation indicates that the majority of women employed in mills, stores and offices are from 15 to 25 years of age. The larger number of women thus employed do not, therefore, work beyond the marriageable age. The wives of workingmen and mechanics are shown from recent statistics to have usually been working-girls before their marriage, and the fact that a girl's earning capacity is established seems to settle in a certain way her value as a home-maker. The effect of the entrance of woman into industrial life is very great; the transition of one third the working population from no pay even to low pay has a great effect. The average wage of the four million women is \$5.24 per week. This seems very low, but it can be explained from the fact that the work in which women now are competing with men was, under different conditions, exclusively women's work. At the beginning of this century all the trades and professions which underlie the home were in the hands of women: spinning, weaving, sewing, cutting, cooking, nursing, baking—all these trades were performed exclusively by women, mostly in their own homes, for which they received no pay beyond board and clothes. With the invention of machinery and the capitalization of great industries, women's trades were taken from the home, and now the great industries of men are founded largely on the simple home trades. Women naturally followed their trades into the factory; and, not having capital or being inventors, they were obliged in most cases to become employees rather than employers. About the middle of the century they were in a very

unfortunate position, and threatened to become a class of unproductive consumers. For the last thirty years, however, they have been coming to the front rapidly, and we hear much of the competition of women in the labor market, which means that they are becoming sufficiently well educated and thoughtful to reassert their right to take part in the world's work.

Mrs. Palmer says that "the two fundamental characteristics of woman's industrial life in our times are, first, freedom of choice as to occupation; and second, a receipt of a fixed wage instead of an indefinite reward for service." Mr. William P. Letchworth recently completed a most important inspection of the poorhouses in New York state, and he reports as the result of these investigations, that it is a most curious and suggestive fact that the number of men as inmates of poorhouses has increased gradually, and the number of women decreased. In the eighth judicial district in New York state there were 1,288 inmates. Of this number 801 were men, and only 375 were women. Mr. Letchworth is of the opinion that this decrease may be attributed to the increased avenues open to women for profitable employment, and the larger use of liquor among men. In Brooklyn, New York, this statement is not carried out by the facts, as the large immigration leaves on the seaboard those verging upon dependence, of whom there are as many men as women. The report of the Illinois Bureau of Labor Statistics for 1882, according to Mr. Ethelberth Stewart, of the Bureau of Labor, states that "fifty per cent of the workingmen of Illinois are unable to support their families without the assistance of their wives, and often of the children. In the cotton-mills towns of New England and the South, house after house is locked up, and little faces peer out of the window; the mother usually has gone to work in the mill." In the cotton-mills of the United States, in 1880, the whole number of employees was 172,540. Of this number 112,859 were women and children, while only 59,685 were men. The twentieth report of the Massachusetts Bureau of Statistics of Labor shows that the employment of women in industries increases three times as fast as the female population. It is claimed by some that the employment of women and children is not greatly on the increase, and this would be true if only one or two states were selected. The stringent child-labor laws of some states, and the lax laws of others, militate against enforcing adequate labor laws. Many of the cotton-mill proprietors are erecting works in the South, where they are not troubled by laws regulating the labor of children. The sweat-shops are an important factor in the labor market; and Mr. Stewart writes: "I have no doubt 15,000 families in New York, 10,000 in Chicago and 1,500 in Boston have no home apart from the rooms in which they make cigars or cheap clothing all day long. In the difference between the 15,000 families in New York and the 1,500 in Boston can be seen the good effect of stringent laws against

child-labor." Very little has been accomplished in the United States in the line of legislating for labor reform for women, far less than in Europe. The percentage of married women engaged in trade has been very small in this country, hence there has been less need for legislative interference; but during the last ten years the number of married women engaged in occupations outside their own home is increasing materially. In Massachusetts, Connecticut, New York and Rhode Island an eight or ten hour law is enforced. In all states in which there are factory inspectors the requirements for sanitary improvement are enforced fairly well. The effect of this legislation has been that thousands of women were discharged, and men employed in their place. Naturally, the great question which presents itself to the thoughtful economist is that of the disintegration of the home. As long as married women can remain in their own homes, the entrance of women into the labor market helps rather than hinders economic conditions, but when the wage of the father falls below the point of living wage and the mother must leave the children either to care for themselves or under the care of strangers, the moral effect is extremely dangerous, and the most thoughtful philanthropists and students of social economics are giving their attention to this important feature of present industrial conditions.

Women have a far larger stake in the finances of the country than is generally known. In real estate alone they control hundreds of millions of property, and in most cases income-paying property, as women rarely buy land for speculation, and where they inherit land it usually is improved in order to secure an income. In railroad bonds they are large holders. It would be impossible to ascertain the exact amount of money controlled by women in such investments. The department of labor at Washington will soon institute such an investigation. The relative numerical position of men and women as investors in building and loan associations is four to one. That is to say, 25 per cent of the shares of stock in such associations are owned by women. In New Jersey every fourth shareholder is a woman, and the present value of the shares held by women in New Jersey is \$6,401,593; by present value is meant dues paid in, together with accrued profits. In New York state women own shares with the present value of \$5,935,554, and a maturity value approximating \$25,000,000. In the city of Philadelphia 34,000 women hold stock valued at \$10,059,861, while the stock matured and withdrawn either in money or in canceled mortgages equals \$15,000,000 more within the maturing period of eight years. By the law of Illinois, New Jersey, New York and Pennsylvania, building and loan stock taken out by women, on which they pay the premium, is theirs in every particular, and not subject to attachment or execution for household debts. In a teachers' building and loan association in New York City, 90 per cent are women earning their own money, many of whom have built several houses for rent through the associa-

tion. Mr. Eckels, comptroller of the currency, sent out to the national banks a request to furnish him with the list of women holding bank stock April 15, 1893. The following is the result: The number of shares owned by women in the United States in national bank stock was 1,703,759. The par value of the shares was \$130,681,485. In state and county banks the par value of shares owned by women was \$145,000,000. Women also control large sums of money in insurance companies, and it is more and more becoming the custom for women to insure their lives for the benefit of husband and children. Ten years ago few insurance companies had agents to canvass among women to secure life insurance; now, hundreds of the best companies have special departments for women.

From this brief statement it will be seen that woman is rapidly becoming an important financial factor in the country, and more and more is she giving to financial interests her time and attention. (See also CLUBS, WOMEN'S, in these Supplements.)

ELLEN M. HENROTIN.

INERTIA. See MECHANICS, Vol. XV, pp. 729-748.

INEZ DE CASTRO. See CASTRO, INEZ DE, Vol. V, p. 202.

INFALLIBILITY OF THE POPE. See VATICAN COUNCIL, Vol. XXIV, pp. 112, 113; and POPedom, Vol. XIX, p. 492.

INFAMY AND INFAMOUS CRIMES. Infamy is the condition or state which the law imposes upon one who is convicted of certain crimes. These crimes are termed infamous crimes, and consist of such offenses as are inconsistent with the common principles of honesty and humanity. The law considers one who has been convicted of an infamous crime to be too much depraved to be permitted to give testimony tending to deprive another of life, liberty or property. The crimes which were considered infamous at common law are treason and felony. In most of the states of the United States the disability of one convicted of an infamous crime to testify as a witness has been removed by statute, but evidence of such conviction may be given as affecting the credit to be allowed to the testimony of such witness. The principal disability which now exists against one convicted of infamous crime is that of disfranchisement at public elections. In most states, however, this disability may be removed by act of the legislature on pardon of the governor. It is provided in the constitution of the United States that no one shall be held to answer for an infamous crime unless upon indictment by a grand jury, except in cases arising in the land or naval forces, or in the militia when in actual service in time of war or public danger. Under this provision of the constitution the United States supreme court has held the term "*infamous crime*" to include any crime which is punishable under the laws of the United States by imprisonment for one year or more at hard labor, and crimes against the United States punishable by imprisonment in a state

prison or penitentiary, whether with or without hard labor.

INFANTE, the title given in Spain and Portugal to the princes of the royal family, the corresponding title of *infanta* being given to the princesses. The personal domain of an infante or infanta is called the *infantado*. The term was formerly applied to any children of noble birth.

INFANTE, JOSÉ MIGUEL, a Chilean statesman; born at Santiago in 1777. He was a leader of the movement for independence, 1811; and was regent while the President was in the field against the Spaniards. He led the movement which drove O'Higgins from the Presidency; was at the head of affairs in the temporary absence of President Freire in 1825, and with the aid of the Senate, which he had organized, abolished slavery and did much toward the adoption of a federal government copied after the United States. He died April 9, 1844.

INFANTRY. See WAR, Vol. XXIV, pp. 354-368; British, see ARMY, Vol. II, p. 580; German, see ARMY, Vol. II, p. 596; French, see ARMY, Vol. II, p. 603; Austrian, see ARMY, Vol. II, p. 605; and Russian, see ARMY, Vol. II, p. 609.

INFANT SCHOOLS. Pastor Oberlin may be regarded as the founder of infant schools. The education and training of young children were also matters of great interest and study to Pestalozzi. The most successful system of educating quite young children is the kindergarten. See KINDERGARTEN, Vol. XIV, p. 79; and OBERLIN, Vol. XVII, p. 704.

INFECTIOUS DISEASES. See PATHOLOGY, Vol. XVIII, pp. 401-407; and MEDICINE, Vol. XV, p. 796.

INFINITE, same as ABSOLUTE. See ABSOLUTE, Vol. I, pp. 57, 58; also CARTESIANISM, Vol. V, p. 144; and THEISM, Vol. XXIII, pp. 247-249.

INFINITESIMALS AND INFINITE, IN MATHEMATICS. See INFINITESIMAL CALCULUS, Vol. XIII, pp. 13, 14.

INFLAMMATION. See PATHOLOGY, Vol. XVIII, pp. 398-401.

INFLATION. See MONEY, Vol. XVI, pp. 726-728.

INFLEXION. See PHILOLOGY, Vol. XVIII, pp. 789, 790.

INFLEXION, POINT OF. See CURVE, Vol. VI, p. 721.

INFLORESCENCE. See BOTANY, Vol. IV, pp. 121-126.

INFORMATION, used in a technical legal sense, is an instrument which contains an accusation exhibited against a person, charging him with a criminal offense. It is the general rule in the United States that prosecutions for offenses punishable by imprisonment in the penitentiary or state prison cannot be maintained upon an information, but must be by indictment of a grand jury. Its principal use in the United States now is in civil prosecutions for penalties and forfeitures. Thus informations are resorted to on account of illegal importation of goods. This is the common method of forfeiting the charters of illegal corporations, in which case the attorney-general or other proper officer of the state files the information. Informations in the United

States must generally be under oath, and are presented by a competent public officer. See INFORMATION, Vol. XIII, p. 73.

**INFORMER.** One who makes an accusation against another, charging the violation of some penal law. Statutes are frequently enacted, which entitle the informer to a part of the penalty upon the conviction of the offender. Such statutes are frequently enacted as to those who inform the proper authorities of the violation of game laws and other similar laws against acts not of a criminal nature except as they are made such by statute. The informer may or may not be a competent witness against the accused, according to the provisions of the statute. He is frequently disqualified from testifying on account of the personal interest he may have in the success of the prosecution.

**INFRINGEMENT**, in the legal sense, is 'the act of trespassing upon some right secured by patent, copyright or trade-mark. Any one who shall make use of or sell any patented article or any literary or other production which is copyrighted, or who shall adopt or use any registered trade-mark without first obtaining the right so to do from the owner thereof or in some other lawful manner, is guilty of infringement and must pay the damage which the owner sustains thereby. Infringements may be prevented by means of a bill in equity for an injunction to restrain further infringements, and an accounting may be had as to the damages sustained by reason of previous infringements. Before any remedy can be had for an infringement it must appear that the patent, copyright or trade-mark which is claimed to be infringed is valid, so that the complaining party has a right to the protection demanded. The mere fact that a patent or copyright has been issued or a trade-mark registered is not sufficient to entitle the person to protection. Many times the article patented or copyrighted is not of such a character as to be a proper subject for such protection. Infringement is the most frequent method of testing the validity of a patent or trade-mark in which case the person claiming to be injured has his remedy by suit for damages or bill for injunction, which will be sustained only when his patent, copyright or trade-mark is valid and in proper form.

**INFUSORIA**, a term for all corticate protozoans except Sporozoa. See PROTOZOA, Vol. XIX, pp. 856-865.

**INFUSORIAL EARTH** or **KIESELGUHR**, a silicious deposit, composed of the frustules of diatoms, and found in certain local strata of the Tertiary age. It is made up of microscopic angular particles, and is used for scouring purposes and in the manufacture of dynamite. It is found in large deposits in a dozen states of the United States. The largest deposit in Europe is found at Bilin, Bohemia.

**INGALLS, JOHN JAMES**, an American statesman; born in Middleton, Essex County, Massachusetts, Dec. 29, 1833. He graduated at Williams College in 1855, was admitted to the Massachusetts bar in 1857, and the following year went to Kansas. In 1860 he was secretary of the territorial council; was secretary of state senate in 1861; and member of

the state senate in 1862. In 1873 he became a member of the United States Senate, as a Republican, and was re-elected in 1879 and 1885. During his last term, which expired March 3, 1891, he was president of the Senate *pro tem*. After that he devoted himself chiefly to lecturing and writing. Died at Las Vegas, New Mex., Aug. 16, 1900.

**INGALLS, RUFUS**, an American general; born at Denmark, Maine, Aug. 23, 1820. Graduated at the United States Military Academy, 1843; served through the Mexican War with distinction, and as quartermaster at various places in the Northwest. In 1861 he became quartermaster of the Army of the Potomac; in 1886 assistant quartermaster general, and in 1867 became chief quartermaster at New York. Finally, in 1882, he became quartermaster general of the United States army, and retired in 1883. He died in New York City, Jan. 16, 1893.

**INGELOW, JEAN**, an English poet and novelist, was born at Boston, Lincolnshire, in 1820.

With Christina Rossetti, Jean Ingelow has, since the death of Mrs. Browning, shared the laurel crown of the female poets in England. Both were idyllic lyrists, and the poetry of each is marked by an introspective religious cast, and by much melody of form. In her early writings, the influence is strong both of Mrs. Browning and Tennyson, and not a little of her best work shows originality and strength. She has written some popular ballads, such as *The High-Tide on the Coast of Lincolnshire*, with its quaint, Elizabethan dialect, and much minor verse of considerable beauty. A collected volume of her poetry first appeared in 1850, which has since been repeatedly reissued, with additions. In 1867 she published another volume of verse, entitled *A Story of Doom*, while a third volume, entitled *Poems by Jean Ingelow*, appeared in 1887. Of her novels the following may be specially mentioned: *Off the Skelligs* (1872); *Fated to be Free* (1875); *Don John* (1876); and *Sarah Berenger* (1880). Died July 20, 1897.



JEAN INGELOW.

**INGERSOLL**, a town of Oxford County, central southern Ontario, Canada, on the Thames River and the Canadian Pacific and the Grand Trunk railroads, 75 miles W. of Hamilton. It contains fine public buildings, and manufactories of woolen goods, cheese and farm implements, and carries on a brisk trade in lumber and grain. Population 1891, 4,191.

**INGERSOLL, CHARLES JARED**, an American statesman; born in Philadelphia, Oct. 3, 1782. He was admitted to the Pennsylvania bar, and was attached to the United States embassy to France. From 1813 to 1815 he was in Congress, and then became United States District Attorney, which office he held till 1829. Shortly afterward he served in

the legislature, and in 1837 became secretary of legation to Prussia. From 1841 to 1847 he was again in Congress, and distinguished himself as a Democratic leader. He wrote a *Historical Sketch of the Second War with Great Britain*, and some other works, poetical and historical. He died in Philadelphia, May 14, 1862.

INGERSOLL, ERNEST, an American naturalist; born at Monroe, Michigan, March 13, 1852. He was educated at Oberlin College and in the Harvard Museum of Comparative Zoölogy. After the death of Agassiz, he became naturalist for the Hayden survey (1873); became a member of the United States Fish Commission, and in 1880 he was special census agent for the investigation of the American oyster industries. Among his publications are *Nests and Eggs of American Birds* (1879); *Friends Worth Knowing* (1882); *Country Cousins* (1884); *The Crest of the Continent* (1885); and *The Strange Adventures of a Stowaway* (1886). Later he turned his attention to the compilation of guide-books and produced some excellent works descriptive of Canada, New York City and the Hudson River.

INGERSOLL, JOSEPH REED, an American lawyer; born in Philadelphia, June 14, 1786. He began the practice of law in Philadelphia, Pennsylvania, and from 1835 to 1837, and again from 1843 to 1849 was a member of Congress. In 1852 he was appointed minister to England, but the following year retired to private life and devoted himself to literature. He was a strong Unionist, and wrote, among various other things, *Secession a Folly and a Crime*. He died in Philadelphia, Feb. 20, 1868.

INGERSOLL, ROBERT GREEN, an American lawyer; born in Dresden, Yates County, New York, Aug.



ROBERT G. INGERSOLL.

11, 1833. He began the practice of law in Shawneetown, Illinois, but in 1857 removed to Peoria; in 1862 became colonel of the Eleventh Illinois Cavalry. In 1866 he was appointed attorney-general for Illinois, and in 1877 refused the post of minister to Germany. He first attracted notice by his eulogy of James G. Blaine, in the National Republican Convention in Cincinnati in 1876, and also by his Decoration-day oration in New York in 1882. But he is known principally on account of his lectures and books, which criticise the Bible and the Christian religion. He wrote *The Gods, and Other Lectures* (1878); *Some Mistakes of Moses* (1879); *What Shall I Do to be Saved? Prose Poems* (1884); and other works. He settled in New York city about 1880. Died at Dobbs Ferry, N. Y., July 21, 1899.

INGHAM, BENJAMIN. See METHODISM, Vol. XVI, p. 185, note.

INGRAHAM, DUNCAN NATHANIEL, an American naval officer; born in Charleston, South Carolina, Dec. 6, 1802; entered the United States navy as midshipman in 1812; became lieutenant in 1818, commander in 1838, captain in 1855, and chief of the Bureau of Ordnance and Hydrography of the

Navy Department in 1856. In 1861 he entered the Confederate naval service as chief of ordnance, construction and repair, and rose to the rank of commodore. He served in the War of 1812, the Mexican and Civil wars. He died in Charleston, Oct. 16, 1891.

INGRAHAM, JOSEPH HOLT, an American novelist and clergyman; born in Portland, Maine, in 1809. After being a sailor and engaging in mercantile pursuits he attended college, and afterward became an instructor in Washington College, Mississippi. Later, he took orders in the Episcopal Church and had a parish at Holly Springs, Mississippi. He wrote *The South-west, by a Yankee* (1836); between 1836 and 1854 a number of wild romances, among them *Lafitte, or the Pirate of the Gulf*; *Captain Kyd*; and *The Dancing Feather*; also *The Prince of the House of David* (1855); *The Pillar of Fire* (1859); and other works. He died at Holly Springs, in December, 1866.

INGRAM, JOHN KELLS, a British educator; born in the county of Donegal, Ireland, in 1823; was educated at Trinity College, Dublin; became professor of oratory and English literature in the same institution in 1846; regius professor of Greek in 1866, and librarian in 1879. He was president of the statistical section of the British Association (1878); also been president of the Irish Statistical Society, the Royal Irish Academy, and a trustee of the National Library of Ireland. He wrote *Greek and Latin Etymology in England*; *The Opus Major of Roger Bacon*; and *The Weak Endings of Shakespeare*. He contributed the articles on *Slavery* and *Political Economy* in this ENCYCLOPÆDIA. The latter paper was republished separately and translated into all the European languages. In 1893 he received the honorary degree of doctor of laws from Glasgow University.

INGRAM PRINTING MACHINE. See PRINTING PRESSES, in these Supplements.

INHERITANCE TAX. The question of whether the estates of deceased persons should be subject to taxation by a special inheritance tax when coming into the hands of heirs, devisees, etc., has been a subject of general interest in the United States within the last decade. While this system of taxation has been in use in some states for over fifty years, yet the justice of such a tax has not been fully conceded, as is shown by the strong opposition which has been manifested against it in those states where this class of taxation has been introduced within the last few years. It would now seem, however, to be the general opinion that inasmuch as under the common law a man has not the inherent right of disposing of his estate after his death, but that such right has been accorded him as a mere concession from the public to whom his estate would naturally go, therefore the state has the full right to impose a tax of this class, even admitting that such a tax is a mere bonus, burden, or a double tax, as its opponents claim. It is by virtue of the laws of the state, and not through any natural right, that heirs, devisees, etc., are permitted to succeed to property of which they, as a rule, have had no part in accumulating, and the

state would have a perfect right to change the rules of inheritance in such manner as might be thought best. The chief advantages of this method of taxation are, that it is perhaps less burdensome than any other, because it takes a portion of property which, under the natural laws, belong to the public. It also tends to lessen the evil of vast accumulations of riches in a family line, and to work a distribution to the interest of all.

The system of taxing collateral and direct inheritances, legacies and successions is in use among the Romans, and perhaps at a still earlier period. In modern times this system of taxation is in use in many of the countries of Europe, among which are England, Germany, Austria, France, Switzerland, Holland, Russia, Italy, Spain, Portugal, Greece, Denmark and Sweden. It also exists in the colonies of Australia, the provinces of Canada, in Chile and Guatemala. The first inheritance tax was imposed in the United States in 1826, in the state of Pennsylvania. Since then many states have adopted laws modeled somewhat after that of Pennsylvania. In Louisiana a tax was imposed upon foreign heirs, which was declared constitutional in 1850. This law was repealed in 1877 and re-enacted in 1894. The following states have now laws imposing an inheritance tax: Virginia, 1844; Maryland, 1845; Delaware, 1869; New York, 1885; West Virginia, 1887; Connecticut, 1889; Massachusetts, 1891; Tennessee, 1891; New Jersey, 1892; Ohio, 1893; Maine, 1893; California, 1893; Louisiana, 1894; Illinois, 1895. Many of these earlier laws have been greatly modified by amendment since their adoption. In New Jersey and Ohio these laws have been declared unconstitutional in part, and similar laws have been declared wholly unconstitutional in New Hampshire and Minnesota. In Minnesota, however, a constitutional amendment was adopted in 1894, permitting inheritance taxes to be imposed. Similar taxes were established in North Carolina in 1847, but the law was repealed in 1883.

The success of the inheritance tax from a financial standpoint has been very great. In the state of New York, since the adoption of this system in 1885, about fifteen million dollars have been collected from this system alone. About one million dollars annually is collected in Pennsylvania, which state has only a collateral inheritance tax and does not impose a tax on property descending directly to lineal heirs. The tendency to establish a tax of this character in states where it has not been done is increasing, and at least some additional states may be added to the list in the near future. Except in the states above mentioned, these laws have been held to be constitutional whenever tested in the courts, and it may be recognized that the principle of taxing inheritances is generally constitutional, and wherever the laws have been held otherwise, it is the fault of the lawmakers in framing them and not the principle itself. But in New Hampshire the principle was said to be contrary to the constitution.

The inheritance tax in England, there commonly called "death duties," was entirely remodeled in 1894. Instead of the five taxes known as probate, account, estate, legacy and succession duties, they

are reduced to three—estate, legacy and succession duties, which three include what was formerly included in probate and account duties. The great change is in estate duties, which are now levied upon the entire estate, real and personal, according to a graduated scale, and based upon the actual market value of the estate. Legacy duties are levied against personal property, and succession duties against real estate, somewhat similar to the old law. See SUCCESSION DUTIES, Vol. XXII, p. 616.

INHIBITION. See PHYSIOLOGY, Vol. XIX, p. 22.

INITIAL HEREDITY. See HEREDITY, in these Supplements.

INITIAL UNITS OF HEREDITY OR BIOPHORS. See HEREDITY, in these Supplements.

INJUNCTION. The rules under which injunctions may be obtained vary quite extensively in the different states of the United States, but it may be stated as a general rule, that a perpetual injunction will not be granted except after notice to the parties who will be affected thereby. In most of the states, however, an injunction will be granted temporarily when it appears to the court before which the application for an injunction is made that great injury or injustice will result by requiring notice to be given. This method of granting injunctions is not usually favored by the courts, and it is generally necessary that the facts warranting the issuance of an injunction without notice shall be fully set forth under oath.

The primary ground upon which injunctions are granted is to prevent irreparable injury. There are a great variety of cases in which the remedy of injunction is applicable, and its use throughout the United States has become very extensive by reason of the prompt and effective results which it affords. The remedy for any violation of an injunction is by an application to the court to punish the party disobeying the injunction for contempt of court in disobeying the mandate of legal process. The punishment will vary according to the gravity of the offense.

In recent years much complaint has been made because of the sweeping effect of some injunctions which have been granted for the purpose of assisting in quelling public disturbances. The practice of granting injunctions against rioters and the leaders of disturbances in cases of great industrial strikes has grown into extensive use, especially by the Federal courts, and has naturally met with much adverse criticism. The granting of injunctions under such circumstances to protect the United States mails and for other similar purposes has frequently been sustained by the supreme court of the United States. This practice of using an injunction to suppress public disturbances has been termed "government by injunction" by some opponents of the practice, and has been harshly criticized. See also INJUNCTION, Vol. XIII, p. 78.

INK-BERRY. See HOLLY, Vol. XII, pp. 101, 102.

INKERMANN. See CRIMEA, Vol. VI, p. 587.

INMAN, HENRY, an American painter; born in Utica, New York, Oct. 28, 1801. He studied with John Wesley Jarvis in New York, and in 1822

opened a studio as a portrait-painter and made quite a reputation for himself. He went to Philadelphia (1832), but in a few years returned to New York. In 1838 he had become famous in this country, but his health began to fail and other troubles came upon him. In 1844 he went to England with commissions from friends to paint for them portraits of Chalmers, Macaulay and Wordsworth. He partially regained his health, and acquired fresh laurels in England. Among his paintings are portraits of Van Buren, De Witt Clinton, Chief-Justice Nelson, Audubon, W. A. Duer, and William H. Seward. Some of his other paintings are *Lake of the Dismal Swamp*; *Newsboy*; *Rip Van Winkle Awakening*; and *An October Afternoon*. He returned to the United States in 1845, and died in New York city, Jan. 17, 1846.

INNATE OR INTUITIVE IDEAS. See LOCKE, Vol. XIV, p. 758; PSYCHOLOGY, Vol. XX, pp. 55-57.

INNERVATION. See RESPIRATION, Vol. XX, p. 480.

INNES, THOMAS, a Scottish historian; born at Drumgask, Aberdeenshire, in 1662. At fifteen he was sent to Paris, where he studied at the College of Navarre and the Scots College. In 1692 he received priest's orders, and after three years of mission work in Banffshire, returned to Paris and became prefect of studies in the Scots College. His *Critical Essay on the Ancient Inhabitants of Scotland* (1729) is much the earliest of all scientific histories. It was meant for an introduction to a *Civil and Ecclesiastical History of Scotland*, one volume of which, coming down to Columba's death, he prepared for the press, while another, bringing down the narrative to 831, was left incomplete. The work retains a permanent value. He died in Paris, Jan. 28, 1744.

INNESS, GEORGE, an American landscape-painter; born at Newburg, New York, May 1, 1825. At the



GEORGE INNESS.

age of twenty-one he began landscape-painting in New York City. He then made visits to Europe, and resided in Florence and Rome for some time. He returned to New York about 1868, and from 1871 to 1875 again lived in Italy. In 1868 he became a National Academician, and in 1889 received a third-class medal at the Paris Exposition. After his death a memorial exhibition of 240 pictures left by him was opened, and sold at auction for \$108,670. This exhibition called renewed attention to the fact that there was an ideality about the best landscapes of Mr. Inness which appealed to the best emotions and sentiments of a cultivated nature. He has taken rank already as one of the best of American landscape-painters. Among his best paintings are *The Sign of Promise: Peace and Plenty: Going Out of the Woods*; *The Valley of the Shadow of Death*; *Summer Sunshine and Shadow*; *Pine Grove*; *American Sunset*; *St. Peter's*; *Rome, from the Tiber*. He

died at Bridge of Allan, Scotland, Aug. 3, 1894; but was buried in America.

INN-KEEPER, one who keeps a public house for the lodging and entertaining of guests who conduct themselves properly and who are able and ready to pay for their entertainment. Such a house in the United States is usually called a hotel. Restaurants, boarding-houses, lodging-houses and other similar public houses are not inns within the meaning of the law, but in some respects such houses are governed by the same or similar rules. The common-law liability of inn-keepers for the protection of the property and personal effects of their guests is quite extreme, and the greatest care and caution are necessary, but by statute in many states of the United States it is provided that inn-keepers may provide iron safes for the purpose of depositing the valuables belonging to their guests for safe-keeping, and, upon posting notices in public places about the hotel to the effect that the proprietor will not be responsible for the loss of valuables unless given to him for deposit in such safe, the inn-keeper will be relieved from liability because of the loss of valuable articles, unless such loss was caused through the neglect or misconduct of the inn-keeper or some of his servants. Other statutory provisions are made in most states for the protection of inn-keepers. In most states it is made a criminal offense to obtain entertainment at a public house with the intention not to pay therefor, and the penalty for a violation is quite severe. As to the common-law rules concerning the liabilities and rights of inn-keepers, see INN-KEEPERS, Vol. XIII, p. 81.

INNOCENTS' DAY, a festival, in commemoration of the massacre of children ordered by Herod with a view of destroying the Saviour, and one of the anniversaries retained by the English Church at the Reformation. It falls on December 28, and in the Middle Ages it was one of the chief festivals. On that day children were dressed in the clothes of their elders and allowed to exercise mock authority; but in some places they were given a whipping to remind them of the original cruelty which gave rise to the day, and everywhere it was considered an unlucky day. At the present time, in some of the Roman Catholic countries, the day corresponds to our All Fools Day, and the remark after a practical joke is, "May your innocence protect you!"

INNUIT INDIANS. See ESKIMO, Vol. VIII, pp. 543-547.

INO, in Greek mythology daughter of Cadmus and Harmonia. Athamas, King of Orchoimenos, by order of Juno had married Nephele, by whom he had two sons, Phrixus and Helle. But he put away Nephele and married Ino, with whom he had been in love. His first wife disappeared, and he was seized with madness and murdered his own son Learchus; and Ino, fleeing in terror with the other son, Melicurtis, threw herself into the sea, where she was transformed into the marine deity Leucothea, and Melicurtis into Palæmon. Athamas was compelled, on account of his crime, to flee from Boeotia into Thessaly.

INOCARPUS EDULIS, a plant of the Pacific islands, belonging to the family *Thymelæacea*, and



remarkable for its peculiarly modified branches, which are flat and board-like, and are used without modification by the natives in the erection of their huts. The nut-like fruit of the tree is edible.

**INOCULATION, IN MEDICINE**, the transference of a disease from one individual to another by insertion of the virus of the disease into the tissues of the body. See **SMALLPOX**, Vol. XXII, p. 162; also **VACCINATION**, Vol. XXIV, p. 23.

**INOCULATION OF PLANTS OR BUDDING**. See **HORTICULTURE**, Vol. XII, p. 237.

**INOSITE OR MUSCLE-SUGAR**, a sweet substance found in various portions of the body of many animals and plants. Though it has the same composition as grape-sugar, it is not a true sugar, but a hexaoxyhexahydrobenzene. It cannot be converted into alcohol by fermentation, but will undergo the lactic-acid fermentation.

**INOUE, KAORU, COUNT**, a Japanese statesman; born in Choshin, in western Japan, 1839. He was convinced, through a secret journey to Europe, that Japan should adopt the methods of Western civilization, and spent the rest of his life advocating this policy. He was appointed Minister of Finance in 1868, and was special ambassador to negotiate a treaty with Corea (1876), after which he was commissioner to the Centennial Exhibition at Philadelphia. On his return was made Minister of Foreign Affairs, an office he held till 1884. In 1885 a peerage was conferred upon him, and in 1887 he retired from public service, but was recalled, in 1892, to the office of Minister of the Interior, the second highest office in the cabinet.

**IN REM**, a technical legal term which is used to designate proceedings against the thing as distinguished from personal actions. Actions to declare a forfeiture against property are actions *in rem*. In actions of this class the property only is liable, and no right of action exists against the owner thereof. Personal actions are said to be actions *in personam*. Frequently actions may be maintained either *in rem* or *in personam*, and sometimes both together. Thus seamen may proceed against the ship for their wages, or against the master or owner thereof.

**INSECT FERTILIZATION**. See **INSECTS**, Vol. XIII, p. 142.

**INSECTICIDE OR INSECT-DESTROYER**. The development during the last few years, especially in horticulture, has necessitated the employment of means to do away with injurious insects. One means adopted has been to introduce birds which prey upon insects; but the commonest process of destruction has been through the use of poisons, fumigation, etc. These latter methods are especially effective after the insect has developed; but about the only way to prevent the egg from hatching is through washings, or, when the egg has been laid on a leaf of the previous year, by digging around the foot of the plant and so turning up the leaves. The various insecticides may be classified loosely under four heads:

(1) **MINERAL Arsenicals**—*Paris Green and London Purple*. Paris green is a fine crystalline powder, containing about 50 per cent arsenic, 30 per cent copper oxide and a small percentage of acid.

London purple is a by-product in the manufacture of aniline dyes, and contains a number of substances, but chiefly arsenic and lime. It is a finer powder than Paris green, but not so effective, and is likely to scald the foliage. Both are used almost exclusively for biting and gnawing insects on the exterior of plants, and may be applied in various ways, the commonest methods being to dissolve in large quantities of water and use as a spray, or by applying as a powder, mixed with lime, flour or some other dust.

*Arsenate of Lead*. Made by mixing three parts arsenate of soda with seven parts acetate of lead and adding a little glucose to make it stick. Its advantage over Paris green is that it can be more easily seen and will not injure delicate foliage; but its destructive powers are no greater.

*Bisulphide of Lime*. This is even better than sulphur, and is diluted easily. It is made by boiling sulphur and lime in a small quantity of water.

*Carbon Bisulphide*. This substance is useful in doing away with root-lice, ants, and insects which infest stored grain. It is exceedingly volatile, and the least spark is liable to explode it. The usual method of application is to pour it into holes near the affected root and cover up quickly; or, in the case of grain, by setting dishes in closed bins and leaving for 24 hours.

*Sulphur*. May be used in water or mixed with some other insecticide for plant-mites; in some cases it may be scattered around alone, or, for animal lice, etc., it may be fed to the animal.

*Tur*. Dissolved in water and sprinkled on the plant, it acts as a repellent, or, smeared on bands and wound about the bases of fruit-trees, it will prevent some insects from ascending and depositing their eggs. It is sometimes used about the nostrils of sheep as a preventive in the same way against the bot-fly.

(2) **VEGETABLE**. *Hellebore*. White hellebore is used as a substitute for the arsenicals, being less injurious to man and the higher animals. It is costlier than the arsenicals, and only serves the same purposes; may be applied either as a powder or diluted with water.

*Pyrethrum*, also sold under the name *Buhach* and *Persian Insect Powder*. It is used as a powder, and is dusted about rooms or wherever the insects are found; acts on insects externally through their breathing-apparatus; and may be used against mosquitoes by fumigation.

(3) **OILS AND EMULSIONS**. *Kerosene*. This is used sometimes as a spray directly against insects, but is liable to injure or kill the plant; if mixed with water it breaks into fine spray and is less likely to damage vegetable tissue. It is used also to kill many insects after they have been shaken or picked from the plant. If a small amount of kerosene is poured on the surface of a pond or stagnant pool it will destroy all forms of water-insects, including the larvæ, and prevent mosquitoes from depositing eggs. However, the oil is used more in emulsions for prevention of all sucking insects and all biting insects when they cannot safely be poisoned.

*Kerosene and soap emulsion*. Boil half a pound of soap in a gallon of water, and add it, while hot, to two gallons of kerosene and mix it thoroughly by force-pump until it attains the consistency of cream. An emulsion of this kind should keep for an indefinite period. The water should be soft or treated with lye before using, either in making or diluting the emulsion. The emulsions are used to spray the plant.

*Kerosene and milk emulsion*. Use a gallon of sour milk and a couple of gallons of kerosene; churn as in the other emulsion until it assumes the consistency of butter.

*Naphthalene* sometimes is used in place of carbon-bisulphide. In the form of crystals it is used to drive away moths and insects from stored grain, and to protect natural-history specimens from the ravages of museum pests.

*Fish oil, train oil and cotton-seed oil*. All these are used to get rid of vermin on domestic animals, and when smeared on points of attack will repel such insects as the horn-fly, the bot-fly, etc. They or any strong-smelling oil may be used against lice, but care must be taken or they may cause the hair to fall off.

(4) **MIXED**. *Corrosive sublimate*. It is a repellent, sometimes used on account of its strong smell.

*Hydrocyanic acid gas.* Generated by placing three ounces of water, an ounce of commercial sulphuric acid and an ounce of fused potassium cyanide in a glazed vessel. The plant or tree is covered with a tent and the generator left inside for about half an hour. The gas is used mostly against scale insects.

*Resin wash.* This is made by boiling thoroughly, and until there is no sediment, 20 pounds resin, 5 pounds of caustic soda, 2½ pints of fish-oil with water, gradually added and before using, amounting to 100 gallons. It is used in countries where long dry seasons assure its continuance on the trees; also as a winter wash in mild climates when the multiplication of insects continues throughout the year. It should be sprayed on plants.

*Soaps.* Any good soap is effective in destroying soft-bodied insects, such as plant-lice or young larvæ. The soap wash is made by dissolving half a pound of soap in a gallon of water; but fish-oil soaps are especially valuable.

*Sulphide of soda wash.* Made by dissolving 30 pounds of whale-oil soap in 60 gallons of water; then boil 3 pounds of concentrated lye with 6 pounds of sulphur and 2 gallons of water; mix both the soap and sulphide, and boil for half an hour. It is used for scale insects, and should be sprayed on while warm.

*Tobacco and whale-oil soap.* These are used as a wash, and tobacco is used alone as a dust, steeped in water, and as a fumigator.

Beside these, there are various processes which cannot be mentioned here; for instance, various methods of getting rid of bed-bugs and house-flies.

**INSECTIVORA.** See **MAMMALIA**, Vol. XV, pp. 400-405.

**INSESSORES** OR **PERCHING BIRDS**, an order of birds, including the perching birds exclusive of the birds of prey. The leading characteristic of birds of this group was the presence of three toes in front and one behind. The group was very artificial, including passerine and many other birds, and is now obsolete in this sense. The term is now often used as a synonym for *Passeres*.

**INSOLVENCY**, see **BANKRUPTCY**, Vol. III, pp. 341-345, and in these Supplements.

**INSPIRATOR**, a form of injector for supplying steam-boilers. It has two chambers, and employs two separate jets of steam, one to raise the water from its source, and the other to force it into the boiler against the pressure of the steam within. The steam acts by suction, on the principle familiarly observed in sprayers for cologne-bottles. The two jets work in combination, the second jet being equivalent to an ordinary boiler-injector.

**INSULATION.** See **ELECTRICITY**, Vol. VIII, pp. 36-40.

**INSULATORS AND CONDUCTORS.** See **ELECTRICITY**, § 6, in these Supplements.

**INSURANCE.** See Vol. XIII, pp. 161-187; also **ACCIDENT, FIRE, LIFE and MARINE INSURANCE**, in these Supplements.

**INSURRECTION**, an uprising of citizens of a country against the government or laws of the country. By the constitution of the United States, Congress is given power to provide for the calling out of the militia to execute the laws of the Union and suppress insurrections. By act of Congress of Feb. 28, 1795, it is provided that whenever the laws of the United States shall be opposed, or the execution thereof obstructed, in any state, by combinations too powerful to be suppressed by the ordinary course of judicial proceedings or by the powers

vested in the marshals by this act, it shall be lawful for the President of the United States to call forth the militia of such state or of any other state or states as may be necessary to suppress such combinations and to cause the laws to be duly executed; and the use of militia so to be called forth may be continued if necessary until the expiration of thirty days after the commencement of the next session of Congress.

**INTEGRAL CALCULUS.** See **INFINITESIMAL CALCULUS**, Vol. XIII, pp. 33-72.

**INTELLECTION.** See **PSYCHOLOGY**, Vol. XX, pp. 75-83.

**INTENSITY.** See **ELECTRICITY**, §§ 16, 20, 21, in these Supplements.

**INTENT**, the design or determination fixed in the mind. The law requires that one cannot be convicted of a criminal offense unless the act was done through a wrongful intent. The wrongful intent must also be combined with a wrongful act. Generally, when a wrongful act has been committed the law will conclusively imply a wrongful intent, in the absence of satisfactory proof to the contrary. Intent must generally be proved by attending circumstances, from which the intent may be inferred. In contracts it is essential to the validity of the document that the intent of the parties was to enter into the contract. In construing wills, deeds, contracts and other instruments the intent of the parties will govern, and such intent must usually be determined by reference entirely to the document, and to every part of it. Statutes are also to be construed according to the intent of the law-makers, which intent must be gathered from the statutes themselves and the attending circumstances. See also **NEGLIGENCE**, Vol. XVII, pp. 315, 316.

**INTERCALARY.** See **CALENDAR**, Vol. IV, pp. 666, 667.

**INTERCOLUMNIATION**, the spacing between columns. See **ARCHITECTURE**, Vol. II, pp. 409, 410.

**INTEREST**, the compensation which the debtor pays to his creditor for the use of money or the detention of the debt. Legal interest is the rate of interest which is established by law, and which will prevail in the absence of an express agreement as to the rate. Usury or usurious interest is a rate of interest in excess of that which the law permits to be charged under express contract. The rate of interest in the United States is governed by the statutes of the various states, which generally fix a legal rate of interest, but provide that by special contract a different rate may be charged, but not in any event to exceed a certain fixed maximum rate. Any rate higher than the maximum rate is made usury, and generally precludes the lender from the right to collect any interest, and in some states the lender at usurious interest forfeits the right to collect either principal or interest. When a contract is sought to be enforced in another state the laws of the state wherein the contract was made will govern, and the rate of interest permitted in such state will be followed. The laws of the various states as to the legal rate of interest are frequently changed. In some states, in addition to the forfeitures shown below, usurious

interest may be recovered, even when paid, if suit for that purpose is brought within time specified. In a few states, when such interest has been collected, double or even triple the amount of such usury may be recovered by the party paying it. In some states the laws are complicated, and many exceptions are allowed as to usury forfeitures.

As a general rule, the legal and maximum rates increase from the eastern to the western part of the United States. The legal rate in the majority of the states is 6 per cent. In Alabama, Colorado, Florida, Oregon and Utah the rate is 8 per cent; in Arizona, California, Georgia, Minnesota, Nebraska, Nevada, North Dakota, Oklahoma, South Carolina, South Dakota and Washington, 7 per cent; in Illinois and Louisiana, 5 per cent; in Idaho and Montana, 10 per cent; and in Wyoming, 12 per cent. The maximum rate does not exceed 10 per cent in the majority of states. In Idaho, however, it is 18 per cent; and in New Mexico, North Dakota, South Dakota and Washington, 12 per cent. Arizona, California, Colorado, Maine, Montana, Nevada, Oklahoma, Rhode Island, Utah and Wyoming either have no usury laws, or provide that any rate contracted for may be collected. Massachusetts provides that not more than 18 per cent can be collected on loans less than \$1,000. Of those states which have usury laws, 15 provide that in case illegal rates are charged the whole interest is forfeited. In Connecticut, Georgia, Indiana, Kentucky, Louisiana, Maryland, Missouri, New Mexico, Ohio, Vermont and West Virginia, all interest above the maximum rate is forfeited. The forfeiture for usury is, in Arkansas, both principal and interest; in Delaware, an amount equal to the money lent; in Idaho, 10 per cent of the debt; in Indian Territory, both principal and interest; in Iowa, all of the interest and 10 per cent of the principal, the latter forfeiture going to the school fund; in Kansas, double the excess above 10 per cent; in New Hampshire, three times the excess above legal rate; in Oregon, the principal is forfeited to the school fund; in South Carolina, double the interest charged; in Tennessee, only the actual debt is recoverable; in Washington, double the rate charged; in New York, usurious contracts are void; in South Dakota and Tennessee, taking of usury is a misdemeanor punishable by fine or imprisonment.

See also INTEREST, Vol. XIII, p. 188; and USURY, Vol. XXIV, pp. 17-19.

INTERFERENCE FRINGES. See WAVE THEORY, Vol. XXIV, pp. 425, 426.

INTERFERENCE OF POLARIZED LIGHT. See WAVE THEORY, Vol. XXIV, pp. 446-448. OF SOUND, see ACOUSTICS, Vol. I, pp. 116-119; and WAVE, Vol. XXIV, p. 421.

INTERIM. See TRUST, Vol. XXIII, p. 596.

INTERIOR DEPARTMENT OF THE, an executive department of the United States government, presided over by the *Secretary of the Interior*, who is a member of the President's Cabinet, and whose general duties are the supervision of patents and inventions; pensions and bounty lands; public lands and surveys; the Indians; education; railroads; the geological surveys; the census, and the reservations and national parks. He also exercises certain powers and duties relating to the territories of the United States. He is assisted by the *First Assistant Secretary of the Interior*, who examines charges against officers and employees; instructs Indian and mine inspectors; supervises matters pertaining to the Indians, to the distribution of certain public documents, to government schools, etc.; and acts as secretary in the absence of that

officer. The *Assistant Secretary of the Interior* considers appeals from the Commissioner of Pensions, on matters relating to violations of the pension laws, and from the Commissioner of Patents; countersigns letters-patent; admits and disbars attorneys and agents practicing in the department; and acts as secretary in the absence of both that officer and the first assistant secretary. The *Chief Clerk* has general supervision of the clerks and employees of the department; the order of business and records; correspondence of the secretary's office; stationery, printing, etc., for the department and its bureaus; and the buildings occupied by the department.

The work of this department is distributed among eight bureaus, as follows:

The *Commissioner of Patents* has charge of all matters relating to the issue of letters-patent for new and useful discoveries, inventions and improvements, and to the registration of trademarks and labels.

The *Commissioner of Pensions* supervises the examination and adjudication of all claims for pensions or bounty lands on account of service in the army or navy during the Revolutionary War and subsequent wars in which the United States has been engaged.

The *Commissioner of the General Land Office* is charged with the survey and sale of the public domain and the issuing of titles therefor.

The *Commissioner of Indian Affairs* has charge of the several tribes of Indians in the states and territories; of their agents and school superintendents; and superintends the purchase and distribution of presents and annuities to the Indian tribes.

The *Commissioner of Education* collects statistics and facts concerning education in the United States; in his reports gives information and suggestions respecting the organization and management of schools, of school systems and methods of teaching; and otherwise labors to promote education throughout the country.

The *Commissioner of Railroads* is charged with the duty of requiring such railroads to report to him as have had granted them by the United States any loan or credit, or subsidy bond or lands. He is required to examine the books and accounts of said railroad companies; to see that the laws relating to them are enforced; to furnish to the departments of the government such information as to tariffs for freight and passengers as may be required or which may be for the interest of the government; and to report annually to the Secretary of the Interior.

The *Director of the Geological Survey* has charge of the classification of public lands and of the government investigations of the geological structure, mineral resources and products of the national domain.

The *Superintendent of the Census* supervises the taking of the census in the United States every tenth year, and the subsequent publication of the statistics collected. The statistics relate to population, to the products of manufactories, mining

and agriculture, to mortality and vital statistics, to public indebtedness, to recorded public indebtedness, to statistics relating to corporations, etc.

**SECRETARIES OF THE INTERIOR.** The following is a complete list of the Secretaries of the Interior from the organization of the Department, with dates severally of their appointment: Thomas Ewing, 1849; James A. Pearce, 1850; Thomas M. T. McKernon, 1850; Alexander H. H. Stuart, 1850; Robert McClelland, 1853; Jacob Thompson, 1857; Caleb B. Smith, 1861; John P. Usher, 1863, 1865; James Harlan, 1865; Orville H. Browning, 1866; Jacob D. Cox, 1869; Columbus Delano, 1870; Zachariah Chandler, 1875; Carl Schurz, 1877; Samuel J. Kirkwood, 1881; Henry M. Teller, 1882; Lucius Q. C. Lamar, 1885; William F. Vilas, 1888; John W. Noble, 1889; Hoke Smith, 1893; David R. Francis, 1896; Cornelius N. Bliss, 1897; Ethan Allen Hitchcock, 1899.

**INTERMITTENT FEVER.** See *Malarial Fever*, under **PATHOLOGY**, Vol. XVIII, pp. 394-396.

**INTERNATIONAL ARBITRATION LEAGUE**, formerly known as the Workmen's Peace Association; was established in 1870 to promote a policy of peace and international arbitration, and for many years has carried on an active peace propaganda in Europe and America. It organized the inter-parliamentary conferences of members of parliaments in favor of international arbitration, which have met for the last six years in various cities of Europe. The society publishes a monthly organ, *The Arbitrator*.

**INTERNATIONAL COPYRIGHT.** See **COPYRIGHT**, in these Supplements.

**INTERNATIONAL EXHIBITIONS.** See **WORLD'S FAIRS**, in these Supplements.

**INTERNATIONAL LAW, PRIVATE**, is a branch of jurisprudence defining the rights and obligations of a subject or citizen of one state residing or making contracts in another state. Referring, as its principles do in the main, to real and personal estate, contracts and obligations, and to domestic relations, one general principle pervades the whole, viz., that in relation to property the *lex loci situs* (law of the place where situate) applies in general, and as regards contracts the *lex loci contractus* (law of the place of contract). Reference may also be made to the titles **DIVORCE**, Vol. VII, pp. 300-305; **DOMICILE**, Vol. VII, pp. 331-353; **INTERNATIONAL LAW**, Vol. XIII, pp. 190-197; **TESTACY**, Vol. XIII, pp. 197, 198; **MARRIAGE**, Vol. XV, pp. 565-569; **WILL**, Vol. XXIV, pp. 570-574; and to the same titles in these Supplements, as well as to **BELLIGERENCY** and **EXTRADITION**.

**INTERPOLATION.** See **TABLES**, Vol. XXIII, p. 13.

**INTERPRETATION.** See **HERMENEUTICS**, Vol. XI, p. 741.

**INTERPRETATION, IN LAW.** See **STATUTE**, Vol. XXII, pp. 469, 470.

\***INTERSTATE COMMERCE LAWS.** The main cause leading to the Interstate Commerce Act was the almost universal dissatisfaction of the people with the methods of the railroad companies,

particularly as regarded the discriminations practiced between persons and places, and the policy of pooling earnings for the purpose of destroying competition. The multiplication of railroads caused wars of rates between the rival companies, resulting invariably in the defeat of the weaker company and its absorption by the stronger, and, finally, in the public being made to pay the whole cost of the war, by rates increased to the limit of all that the traffic would bear. Complaints of extortion, unfair dealing and worse practices were made against the railroads, so that the authorities were constrained to take cognizance of them.

Legislation which indicated the reserve power of the state to supervise the workings of the railroads had been enacted almost from the beginning. As early as 1845 New Hampshire provided for an official charged with the collection of information respecting railroads and the study of their relations to the state. In 1855, New York, Connecticut and Vermont took similar action. In 1858, Maine established an experimental railroad commission; Ohio established one in 1867, and Massachusetts in 1869. Even the regulation of rates had been the subject of legislation in various states, in one so early as 1850.

It was the Granger agitation, however, that brought railroad regulation prominently to attention as a subject for state legislation. This movement was the outcome of a spirit of discontent among the farmers of the states of Illinois, Wisconsin, Iowa and Minnesota, acting in unison as members of an organization called the National Grange. (See **FARMERS' ORGANIZATIONS**, in these Supplements.) The panacea for grievances was the reduction in transportation charges, which the Grangers sought—first, by the passage of state laws fixing rates, either through commissions or by statutes, at figures satisfactory to farming interests; and second, by obtaining Congressional aid in cheapening through movements, either by the improvement of waterways, regulation of charges of trunk lines, or the construction of a cheap national freight railway. All of these methods found earnest advocates.

The contention, by the railroad companies, that the states had no power to fix rates was disposed of by the supreme court of Minnesota, which decided, in a case against the Winona and St. Peter railroad, that the railroads are simply improved public highways, and that, as such, the right to prescribe a rate of tolls and charges is an attribute of the sovereignty of the people, of which no legislature can divest them. Furthermore, the United States supreme court established the precedent, that while Congress has the power to treat the subject of interstate commerce as a whole, any state, in the absence of national legislation, has the power to regulate such interstate commerce as affects its citizens, whether the transportation extends beyond the state or not.

As early as 1870, Ohio, Illinois, Iowa, Wisconsin and Minnesota began to respond to the demands of the Grangers with legislation aiming at the curtailment of railroad earnings, the regulation of charges and the obviating of causes of grievance and complaint.

The culminating point in this restrictive legisla-

tion was reached in 1874, when the so-called Potter Law was enacted in Wisconsin, and a state railroad commission established to carry out its provisions. The Potter Law divided the railroads of the state into three classes, and fixed rates of fare and freight for each class. Class A included all lines whose gross earnings per mile were \$4,000 or more; Class B, \$3,000, or any sum less than \$4,000; Class C, less than \$3,000. Class A was limited to a charge of 3 cents per mile for passengers; Class B, to 3½ cents per mile; and Class C, to 4 cents per mile. The law also divided freights into four general classes and seven special ones, the latter being confined to car-load freights. Railroads of Classes A and B were limited, for freight of Class D, which included grain in bulk, to a charge of 6 cents per hundred pounds for the first 25 miles, 4 cents for the second 25 miles, and 2 cents for each additional 25 miles. Class B railroads were forbidden to charge more than the rates which they charged on June 1, 1873. At the same time, the Maximum Rate Law, identical in its provisions and prohibitions with the Potter Law, except that no commission was established under it, was enacted in Iowa. The railroads refused to obey these laws, on the ground of their unconstitutionality, and applied for injunctions restraining the state officers from enforcing them; but the state courts, and finally the United States Supreme Court, declared them valid.

Other states followed those named with similar legislation, and state railway commissions began to be established and to become regular institutions in most of the states, some of the Southern states, as well as Western and Northwestern states, having substantially adopted the entire Granger system of railway regulation.

The Grangers demanded national as well as state action for their relief, and accordingly a committee was appointed by the United States Senate, in December, 1872, of which Senator Windom of Minnesota was chairman, to investigate and report upon the subject of transportation between the interior and the seaboard. After the most searching inquiry that had ever been made in all matters affecting through rail and water movements, the committee made a lengthy report in April, 1874, recommending that laws should be passed, providing, among other things, for the establishment of a national bureau of information, charged with the duty of obtaining and publishing annually such facts in relation to interstate commerce as would enable Congress to legislate intelligently on the subject. The committee announced, however, that it was of the opinion that the problem of cheap transportation might be better and more quickly solved, not by direct Congressional regulation of existing lines, but through competition furnished by one or more double-track freight railways, honestly and thoroughly constructed, owned or controlled by the government, and operated at a low rate of speed, and by waterways improved and extended at the national expense or by appropriations of Congress.

The recommendations of the Windom committee with regard to the government furnishing the competition thought necessary to the solution of the

railway problem, brought about no immediate action beyond the canvassing of several more or less visionary schemes, but the discussion which followed resulted in the introduction of various measures for the regulation of the railways, and finally in the passage of the Reagan Bill on Jan. 8, 1885. This bill had been advocated through four sessions of Congress, and made its nearest approach to success in its passage by the House. In the Senate it was opposed by the Cullom Bill. The Senate (Cullom) bill, when passed, went to the House of Representatives, and was referred to the committee on commerce, of which Mr. Reagan was chairman.

The House and Senate bills had much in common. Both bills attempted to define and prohibit discrimination and unreasonable rates, declared such offenses misdemeanors, and provided civil remedies and criminal penalties for them. The Cullom Bill prohibited rebates and drawbacks only where they inflict unjust discriminations, while these practices were altogether forbidden by the Reagan Bill; pooling was forbidden by the Reagan Bill, while the Cullom Bill would refer the subject to the commission, the creation of which was one of its distinctive features; the Reagan Bill forbade the charging of a greater rate for a short than for a long haul which included the shorter. But the most important difference was in the legal remedies provided against offenses prohibited. While the Cullom Bill provided for the establishment of a board of nine railway commissioners with power to hear complaints, assess damages, and certify cases to the district courts of the United States if companies refused to pay such damages, the Reagan Bill left its provisions to be enforced by the existing courts, only seeking to make the remedy more direct and easy.

After another session, in which each branch of Congress insisted upon its own measure, a bill uniting the commission feature of the Cullom Bill with most of the prohibitions and civil remedies of the Reagan Bill, was agreed upon in the House, and passed that body on July 30, 1886. A conference committee was appointed, and at the second session of the Congress, that committee agreed upon a report, which was presented to the Senate Dec. 16, 1886. It received the approval of the President of the United States on Feb. 4, 1887. The commission was organized March 31, 1887, and entered at once upon its duties. The other provisions of the act took effect April 5, 1887.

This act to regulate commerce was passed under the authority conferred upon Congress by the Federal constitution, "to regulate commerce with foreign nations, among the several states and with the Indian tribes."

As early in its existence as 1889 it was decided that the Interstate Commerce Commission was not a judicial tribunal within the meaning of the constitution.

By section 12 of the act the commissioners were empowered to subpoena witnesses and require them to produce books, papers, records, etc. In case of disobedience to a subpoena or refusal of a witness to appear before the commission and give testimony or produce books, papers and documents,

the commission was directed to appeal to the courts.

In November, 1890, one Charles Counselman was subpoenaed to testify before the United States grand jury in the northern district of Illinois touching alleged violations of the penal provisions of the act. The witness refusing to testify, and being held in contempt, appealed to the United States supreme court, and on Jan. 11, 1892, that court held said section to be unconstitutional. On Feb. 11, 1893, Congress enacted that the Interstate Commerce Commission was empowered to compel the attendance of witnesses and their testimony, including the producing of books, papers and documents, but provided that no such testimony should be used against the witness in any subsequent proceedings. This act was declared unconstitutional on Feb. 11, 1894, in that it required testimony which would incriminate witnesses. In March, 1896, the supreme court of the United States reversed the decisions of the lower courts, and decided that the amendment does not conflict with the constitution, and must stand. For applications of this law, see RAILROADS, in these Supplements.

JOHN P. MEANY.

INTERVALS. See MUSIC, Vol. XVII, p. 78.

INTESTINES. See DIGESTIVE ORGANS, Vol. VII, pp. 225-229.

INTOXICATING-LIQUOR LAWS. See LIQUOR LAWS, in these Supplements.

INTOXICATION, IN LAW. As a general rule, when a party, enters into a contract while intoxicated to such an extent as to be deprived of the exercise of his understanding, he may avoid such contract upon recovering his mental faculties. This rule is generally true, even though the intoxication was voluntary, but not when the party became intoxicated for the purpose of making the contract voidable.

In criminal law it is the rule that intoxication will not, in any manner, excuse or justify the commission of a crime. This is true, even though the person was so intoxicated as to be practically insane at the time of committing the crime. But the fact of drunkenness may be shown in mitigation of the offense, for the purpose of determining the purpose, intent or motive which actuated the commission of the crime. Thus, intoxication may be shown in rebuttal of charges of malice, and, when taken in connection with other facts, may operate to lessen the degree of the offense. But when the accused determined upon the act while sober and became intoxicated for the purpose of fortifying himself to commit the act, he will not be relieved in any particular because of being intoxicated. See DRUNKENNESS, Vol. VII, pp. 481-483.

INTRENCHED CAMPS. See FORTIFICATIONS, Vol. IX, p. 466.

INTROIT, an anthem sung in the Catholic Church by the choir at the beginning of high mass, while the celebrant, assisted by the deacon and subdeacon, is engaged in saying the *Judica me, Deus* and *Confiteor* at the foot of the altar.

The words are generally, though not always, taken from the Scriptures.

INTUITIONAL SCHOOL. See ETHICS, Vol. VIII, pp. 603-605.

INTUSSUSCEPTION, a term applied in physiological botany to a theory as to the mechanics of growth of the cell-wall, according to which this growth is due to the intercalation of new particles between those already existing. This theory is opposed to that of *aposition*, according to which the new material is deposited upon the internal surface of the cell-wall.

INULIN. See BOTANY, Vol. IV, p. 88.

INUNDATIONS. See RIVER ENGINEERING, Vol. XX, pp. 571, 572.

INVARIANT. See CURVE, Vol. VI, p. 722.

INVERSION, CHEMICAL. See SUGAR, Vol. XXII, p. 623.

INVERSION, ELECTRIC. See ELECTRICITY, Vol. VIII, p. 33.

INVERSION, IN MUSIC, a term denoting certain changes in melodies, chords or harmonies, bearing five different significations.

(1) In counterpoint it signifies the repetition of a phrase or passage with reversed intervals, or by contrary motion, and is a device very frequently used in the construction of fugues in order to secure variety.

(2) Double counterpoint is said to be inverted when the upper part is placed beneath the lower, or *vice versa*. The inversion may take place in any interval, thus giving rise to 14 different species of double counterpoint.

(3) When the lowest notes of an interval are raised an octave higher, and thus placed above the highest, or *vice versa*, the interval is said to be inverted. The process of inversion changes the name of an interval, and, to a certain extent, changes its nature in some cases. However, the essential character survives the operation unchanged, and appears with equal force in the inversion. No matter how they are taken, consonant intervals remain consonant, dissonant remain dissonant and perfect remain perfect.

(4) A note is said to be inverted when any note, other than the root, is taken in the lowest part.

(5) A pedal point is inverted when the sustained note, in place of being in the bass, is transferred to an upper or middle part.

INVERTEBRATA. See SKELETON, Vol. XXII, p. 106.

INVINCIBLES. See HOME RULE, in these Supplements.

INVOLUCRE. See BOTANY, Vol. IV, p. 120.

INVOLUTE. See MECHANICS, Vol. XV, pp. 679, 680.

IODIFORM, a compound of carbon, hydrogen and iodine, made by treating alcohol or acetone with iodine and caustic alkali. Hexagonal yellow crystals, having a peculiar, persistent odor, soluble in alcohol and ether, insoluble in water. Used in medicine as an antiseptic and in small doses, and sometimes, though rarely, given internally.

IOLA, a city and railroad junction and the

capital of Allen County, southeastern Kansas, situated on Neosho River and on the Atchison, Topeka and Santa Fé and the Missouri Pacific railroads, 38 miles W. of Fort Scott. The region is a fine agricultural locality and the city manufactures furniture and other goods, and quarries building and paving marble. An artesian well, 736 feet deep, supplies mineral water, and natural gas heats and lights the town. Population 1895, 1,565.

**IOLAUS**, in Greek mythology, son of Iphicles and Antomedusa, also friend and charioteer of Hercules. He assisted Hercules in the fight against the Lernaean Hydra, with Cynctus, with Geryones, and in the expedition against Troy. He was in the Argonautic expedition and the Calydonian boar hunt, and won the first Olympian chariot race with the horses of Hercules. He, with the children of Hercules, introduced civilization into the Island of Sardinia, and was worshipped by the inhabitants; was the first to worship Hercules after his death. After his own death he returned from the shades to assist the children of Hercules. He slew Eurystheus, and then went again to the shades.

**IOLCUS**. See **THESSALY**, Vol. XXIII, p. 299.

**IOLITE**. See **MINERALOGY**, Vol. XVI, p. 418.

**ION**, in Greek mythology, a son of Apollo and Creusa. He was taken to his father's temple at Delphi and educated. When Creusa and her husband, Xuthos, came to consult the oracle as to the means of obtaining an heir, Xuthos was prevailed upon by a false oracle to take Ion for his son. Creusa tried to poison the youth, and, when she failed, fled to Delphi, where she learned from a priestess that Ion was her son. The Ionians had a tradition to the effect that it was from him they received their name. Others represent him as helping the Athenians against the Eleusians, and later becoming their king.

**IONIA**, a city and the capital of Ionia County, central south Michigan, situated on Grand River and the Detroit, Grand Haven and Milwaukee and the Detroit, Northern and Lansing railroads, 32 miles E. of Grand Rapids. Agriculture and the lumber business are the leading industries. It contains the state asylum for insane criminals, and the state house of correction and reformatory. The place contains the railroad repair-shops of the Detroit, Lansing and Northern railroad, and various mills and factories. Population 1890, 4,482; 1900, 5,209.

**IONIAN SEA**, that part of the Mediterranean which lies between Greece and European Turkey on the east, and Italy and Sicily on the west. It forms the gulfs of Taranto and Patras, and communicates with the Adriatic Sea by the Strait of Otranto. It contains all the Ionian Islands, except Cerigo.

**IONIC DIALECT**. See **GREECE**, Vol. XI, p. 134.

**IONIC ORDER**. See **ARCHITECTURE**, Vol. II, pp. 405-407.

**IOS**, a small island in the Ægean, said to have contained the tomb of Homer, and claiming to be

his birthplace. Its modern name is Nio. It has a fine harbor and about 4,000 inhabitants.

**IOWA**. The population of Iowa in 1900 was 2,231,853. The number of inhabitants in 1890

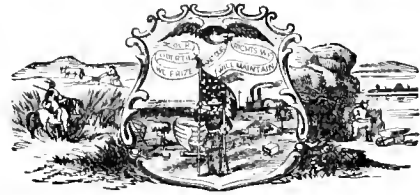

STATE SEAL OF IOWA.

was 1,911,896, the gain for the ten years being 16.07 per cent. In 1890 the native-born citizens constituted 83.05 per cent of the entire population, the foreign-born 16.95 per cent. The negroes numbered 10,685, an increase for the decade of 1,169. The males numbered 994,453, the females 917,443. The number of persons to each square mile of territory was 34.46. In no state of as many inhabitants, except Texas, does the urban population constitute so small a percentage of the total number, the 12 cities of the state having 269,230 inhabitants, which is only 14.08 per cent of the whole. A state census was taken in 1895, which showed a total of 2,058,069, a gain since 1890 of 146,173.

The following table shows the area devoted to the cereals in 1889, the product in bushels of each, the relative standing of the state, and the percentage of the entire area and yield of the United States:

PRODUCT.	ACRES.	PER CENT.	RANK	BUSHEL.	PER CENT.	RANK
All cereals---	12,560,890	8.96	2d	483,198,008	13.73	1st
Corn-----	7,585,522	10.52	2d	313,130,782	14.75	1st
Oats-----	3,752,141	13.25	2d	146,679,289	18.13	1st
Barley-----	518,729	16.11	2d	13,406,122	17.11	3d
Rye-----	93,707	4.31	7th	1,445,283	5.09	7th
Buckwheat---	25,243	3.02	5th	286,746	3.85	6th
Wheat-----	555,548	1.74	18th	8,249,786	1.76	19th

Although Illinois had the largest cereal acreage, Iowa exceeded it in total production by 14,554,148 bushels. Of the total cereal production of the United States, more than one half was contributed by the five states of Iowa, Illinois, Kansas, Nebraska and Missouri; 35.38 per cent of the total land surface of Iowa was devoted to the cultivation of the cereals. During the ten years (1880-90) there were added to the meadow lands of the state, to be mown for hay, 2,748,891 acres, a greater gain in this connection than was made by any other state. The amount of land devoted to the cultivation of corn was increased during the same period by 969,378 acres, the number of swine by 2,000,000, the number of horses by 519,757, and the number of milch cows by 644,231. The county of Delaware was at the head of all counties of the country, with 1,630 cows to each 1,000 of the population. In 1889 there were more horses foaled in Iowa than in any other of the states of the north-central division, the number being 188,932. The largest number of neat cattle

to each square mile of surface was found in Iowa, the average being 88.25.

In the census year the state had 201,903 farms, an increase of 16,552 during the ten years preceding. The average acreage was 151, the total 30,491,541, about eighty-three per cent of which was improved. The total value of the land, fences, buildings, farm machinery and implements and the live-stock was estimated at \$1,100,682,579, and the estimated value of the farm products for the year \$159,347,844. The number of horses was 1,312,079; mules, 41,648; neat cattle, 4,895,550; swine, 8,266,779; and sheep, 547,394, the wool from which amounted to 2,649,652 pounds. The state reports for 1895 show an increase in all matters reported above, and give the total value of the farm products for the year as \$168,235,420. Much attention is given to dairying, and the production of butter and cheese is one of the foremost agricultural industries, there being in operation in 1895, 774 creameries and 81 cheese factories. The most intelligent attention is given to the work, there being dairy departments attached to all of the agricultural colleges, winter schools opened for instruction in the latest methods, and thousands of bulletins on the subject are annually distributed to the farmers of the state. The value of the butter shipped by railroads in 1895 was \$13,295,821. Stock-raising also receives much attention, the state having many herds of the finest breeds of cattle, horses, sheep and swine in the United States.

The census returns for 1890 show the following in regard to the manufactures of Iowa:

INDUSTRY.	NUM- BER.	CAPITAL.	WORK- ERS.	PRODUCT.
				Dollars.
All industries -----	7,449	77,513,097	59,174	125,049,183
Slaughtering and meat packing, wholesale.	25	4,105,020	2,125	19,915,386
Flouring and gristmill products -----	441	6,696,759	1,749	11,833,737
Lumber and other mill products from logs or bolts -----	137	17,457,825	7,011	11,829,065
Cheese, butter and condensed milk, factory product.---	497	2,974,177	2,545	10,545,182
Cars and railroad shop construction -----	41	2,204,648	3,893	4,473,089
Printing and publish- ing -----	643	3,501,710	3,576	3,818,623
Slaughtering, whole- sale -----	4	380,000	600	3,810,190
Lumber, planing-mill products -----	46	3,944,145	2,095	3,558,856

In addition to the above, the manufacture of carriages and wagons, foundry and machine products, printing and publishing and linseed oil were all industries of importance.

Although strictly an agricultural state, Iowa produced mineral products in 1889 of the value of \$10,267,068. Among these products were gypsum, lead, zinc, limestone and lime.

Coal is found in great quantities in the south, central and southeast portions of Iowa. The reports of the state mine inspectors for the fiscal period ending June 30, 1895, make a showing of

the following facts: During the fiscal year ending June 30, 1895, there were 342 mines in operation, producing 3,195,836 tons of coal; 10,992 persons were employed, who received in excess of \$3,300,000 for their services. The total value of the product at the mines was \$4,376,434.

The report of the state auditor for the biennial fiscal period ending June 30, 1895, makes the following showing; values for the years indicated in the table are also given for comparison:

EQUALIZED ASSESSMENT OF LANDS AND TOWN LOTS: 1895, 1890 AND 1885.

	1895.	1890.	1885.
Equalized assess- ment of lands and town lots.---	\$413,970,588	\$374,753,112	\$353,614,837
Assessm't of rail- road property.---	44,521,225	42,902,608	31,672,339
Telegraph and tel- ephone compa- nies -----	665,532	663,874	293,046
Total equalized assessment of state -----	\$559,650,824	\$523,862,858	\$488,953,127

The total amount of taxes received for the year 1894 was \$18,517,283, of which \$17,109,257 was apportioned to the county, district and city tax fund, the remainder to the state fund. The state treasurer reported for the same period covered by the report of the auditor that he had received from all sources the sum of \$3,704,888. The total disbursements for the two years were \$3,758,051. The amount of the permanent school fund held by the several counties was, on the 30th day of June, 1895, \$4,696,671.

The state census taken in 1895 shows the number of persons in the commonwealth liable to military duty to be 413,000. The report of the adjutant-general for the same year gives the strength of the national guard at 2,369 officers and enlisted men; appropriation for the years 1894 and 1895, \$90,000, of which \$85,104 was disbursed. The guard is in a high state of efficiency, and performed services of great value to the state during the riots occurring in the summer of 1894.

The report of the auditor of state shows the following to be the condition of the state and savings banks of Iowa on the 29th of June, 1895:

	No.	ASSETS AND LIABILITIES.	DEPOSITED.	CAPITAL STOCK
Savings banks	170	\$37,385,630	\$28,158,489	\$7,423,400
State banks---	194	26,659,427	15,668,647	8,737,900

Comparing the bank reports of 1893 with the above shows a gain of 22 savings banks and 17 state banks. At that time there were 154 national banks and 185 private banks, which had combined capital amounting to almost \$30,000,000, and aggregate deposits to almost \$60,000,000.

The report of the state commissioner of rail-



roads for 1895 shows that the mileage within the state was 8,486.36, the 38 roads doing business in Iowa having a total of 27,401.19 miles of track. The total earnings for the year of all the roads was \$137,168,249, the proportion for Iowa being \$35,823,879. The total operating expenses were \$94,201,681, the proportion for Iowa being \$24,726,072, which included state taxes amounting to \$1,388,226.

The superintendent of public instruction reported, under date of Nov. 1, 1895, the following facts relative to the public schools of Iowa: Number of persons of school age in the state (5 to 21 years), 712,941; number enrolled in the public schools, 533,824; total average attendance, 339,300; total number of school-houses, 13,613; number of volumes in school libraries, 151,561; total expenditures for school purposes for the year, \$8,317,875, of which \$5,075,492 were for teachers' salaries. Institutions of higher education are many. The University of Iowa (q.v., in these Supplements) is the leading college of the state. The Agricultural College is in a flourish-condition, and receives liberal appropriations

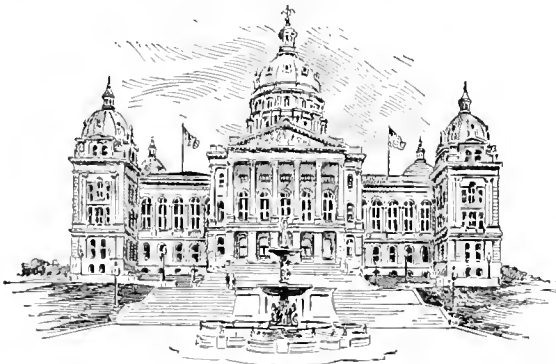

STATE CAPITOL BUILDING, DES MOINES.

from the state in addition to the large amount received from the general government. The State Normal School, at Cedar Falls, had, in 1895, 888 pupils; the amount paid for teachers' salaries was \$26,800, and the total expenditures for the two years ending June 30, 1895, \$97,794. In 1895 there were 17 denominational colleges and universities, with a total attendance of over five thousand, and the various academies and seminaries had an aggregate of about three thousand. There were many business colleges and normal schools.

Of the denominational institutions of learning in Iowa, the Methodist Episcopal Church controls the following: German-English College, at Charles City; Upper Iowa University, at Fayette; Simpson College, at Indianola; Cornell College, at Mt. Vernon; Iowa Wesleyan University and German College, both at Mount Pleasant, and the University of the Northwest, at Sioux City. The Presbyterian Church controls Coe College, at Cedar Rapids; Parsons College, at Fairfield; Lenox College, at Hopkinton, and Buena Vista College, at Storm Lake. The Baptist Church has Des Moines College, at Des Moines, and Central University of Iowa, at Pella. The Congregational Church has two institutions: one at Grinnell,

known as Iowa College, and Tabor College, at Tabor. The Lutheran Church has Luther College, at Decorah, and Wartburg College, formerly at Waverly, but in 1895 removed to Clinton. The Christian Church has Oskaloosa College, at Oskaloosa, and Drake University, at Des Moines. The Friends maintain Penn College, at Oskaloosa, and the United Brethren Western College, at Toledo. Two non-sectarian institutions are operated, one at College Springs, known as Amity College, and the other, the State University of Iowa, at Iowa City.

Among the state charitable institutions are three insane hospitals in operation and another under course of construction. The following is condensed from the reports for 1895:

	MOUNT PLEASANT HOSPITAL.	INDEFIN- DENCE HOSPITAL.	CLARINDA HOSPITAL.	TOTAL.
No. of patients July 1, 1895----	870	940	590	2,406
Amt. rec'd since July 1, 1893----	\$292,719	\$311,253	\$229,908	\$833,880
Amt. exp'ded for same period.	292,461	307,842	218,230	818,533

A hospital contracted for in 1894 is to be located at Cherokee, on a large tract of land eligibly situated, and to be of the most modern construction. The building of this additional hospital was made necessary by the reports of the officials of the several counties, which showed that 793 insane persons were confined in the county poor-houses, 265 in private hospitals at the expense of the state and 80 in the care of friends. The capacity of all of the three institutions being already exceeded, the new one became a necessity.

Other charitable institutions of the state made reports for the biennial period ending June 30, 1895, from which the following facts are taken, the number of inmates being that of the end of the period, and the amount of the operating expenses for the two years being given:

Institution for Feeble-Minded Children	574	\$226,435
College for the Blind	228	72,366
School for the Deaf	306	93,653
Industrial Home for the Blind	40	19,868
Industrial School	145	39,531
Soldiers' Orphans' Home and Home for Indigent Children	458	107,899
Benedict Home (for women)	304	10,633
Soldiers' Home	466	107,150

The state has two penitentiaries, one located at Anamosa, the other at Fort Madison. The former reported 542 convicts June 30, 1895; the expenditures for the two years preceding, \$235,000. The latter reported 441 convicts; and expenditures for the same period, \$156,628. Both institutions were crowded to their full capacity at the date of the reports.

No church statistics of Iowa have been taken since the Federal census of 1890, at which time there were 5,539 organizations, 4,539 edifices, 556,817 members, which constituted 29.12 per cent. of the population. Of the denominations represented there were 500 Baptist bodies, 441

Roman Catholic, 285 Congregationalist, 403 Disciples, 1,342 Methodist Episcopal, 518 Presbyterian bodies, 236 United Brethren, and smaller bodies of almost all denominations.

Jan. 1, 1899, there were 1,109 newspapers published in Iowa. In each of the 99 counties of the state one or more papers were issued, and in all of the county capitals except one; 70 of the papers were daily, 6 triweekly, 45 semiweekly, 886 weekly, 2 fortnightly, 7 semimonthly, 97 monthly, and 1 quarterly. The increase in the number of publications since Jan. 1, 1894, had been 158.

The principal cities of the state, together with the population as given by the census of 1900 are as follows: Des Moines, the capital, 62,139; Dubuque, 36,297; Davenport, 35,254; Sioux City, 33,111; Burlington, 23,201; Cedar Rapids, 25,656; Council Bluffs, 25,802; Clinton, 22,698; Ottumwa, 18,197; Keokuk, 14,641; Muscatine, 14,073; Marshalltown, 11,544; and Fort Dodge, 12,162.

Following is a list of the governors of Iowa, and their respective terms of office: Ansel Briggs (1846-50), Stephen Hempstead (1850-54), James W. Grimes (1854-58), Ralph P. Lowe (1858-60), Samuel J. Kirkwood (1860-64), William M. Stone (1864-68), Samuel Merrill (1868-72), Cyrus C. Carpenter (1872-76), Samuel J. Kirkwood (1876), Joshua G. Newbold (1876-78), John H. Gear (1878-82), Buren R. Sherman (1882-86), William Larrabee (1886-90), Horace Boies (1890-94), Frank D. Jackson (1894-96), Francis M. Drake (1896-98), Leslie M. Shaw (1898-1900). See also IOWA, Vol. XIII, pp. 207-09.

IOWA AGRICULTURAL COLLEGE, a state institution established in 1858, and benefited by the land-grants made by Congress in 1862 to such states as had established or should establish colleges of agriculture and the mechanic arts. These land-grants formed the basis of the present endowment of the college—about \$650,000. The college is equipped with a farm of 900 acres, buildings costing about \$350,000, apparatus required by the courses of study valued at \$100,000, a library of 10,000 volumes, and a museum containing large collections. The income amounts to about \$70,000. There is a faculty of 44 teachers and a student body of about 600.

IOWA CITY, the capital of Johnson County, central eastern Iowa, and the capital of the state from 1839 to 1856, situated in Lucas township, on the east bank of the Iowa River, 120 miles E. of Des Moines, on the Burlington, Cedar Rapids and Northern and the Chicago, Rock Island and Pacific railroads. It is the seat of the Iowa State University, organized in 1860, and Iowa City Academy. It contains, besides many important public buildings, a large paper-mill, a foundry, manufactories of carriages, alcohol, flour, beer, linseed oil, pumps, plows, a flax-mill, glove factory and a pork-packing plant. Population 1880, 7,123; 1890, 7,016; 1900, 7,987.

IOWA COLLEGE, the oldest college in Iowa, situated at Grinnell. It was founded by Congregationalists at Davenport in 1847, but in 1860

was removed to Grinnell. The school, though strongly under Congregational influence, is non-sectarian. It admits women, and has a preparatory department. The value of the buildings, grounds, and equipments is about \$250,000, and its income amounts to \$48,000. In 1898 there were a library of 26,000 volumes, a faculty numbering 32, and a student body of 506.

IOWA FALLS, a railroad junction of Hardin County, Iowa, on the Iowa River, the falls of which at this point give the name to the town, and on the Burlington, Cedar Rapids and Northern, the Chicago, Iowa and Dakota and the Illinois Central railroads; 38 miles N.N.W. of Marshalltown. It manufactures flour, machinery, tiles, plows, ditchers, wire mattresses and butter-tubs. It ships farm produce and stone. Population 1900, 2,840.

IOWA, UNIVERSITY OF. See UNIVERSITY OF IOWA, in these Supplements.

IPALES, a town of southeastern Colombia, on the San Miguel River; on a plateau between the Cordillera Central and the Cordillera Occidental, at an elevation of 11,108 feet. It has the only custom-house for the Equator trade, though this is very small. The roads are poor and the climate cold. Population, 13,000.

IPOMCEA. See JALAP, Vol. XIII, p. 547.

IPSAMBUL, same as ABOOSIMBEL. See ARCHITECTURE, Vol. II, p. 388.

IPSUS, BATTLE OF. See MACEDONIAN EMPIRE, Vol. XV, p. 142.

IPSWICH, a town of eastern Essex County, Massachusetts, on Ipswich River, 3 miles from the Atlantic and 27 miles northeast of Boston, on the Boston and Maine railroad. The town was settled in 1642, and was originally the county seat. It has manufactories of silk, hosiery, shoes, isinglass, soap and woolen fabrics, and extensive clam-digging industries. It contains the Manning High-School, the Heard Public Library, with 15,000 volumes, a house of correction and an insane asylum. Population 1900, 4,658.

IRANIAN LANGUAGE AND LITERATURE. See PERSIA, Vol. XVIII, pp. 653-655.

IRAPUATO, a city in the state of Guanajuata, Mexico, on the Mexican Central railroad, 219 miles of N. Mexico City, 6,000 feet above the sea. It was founded in 1547, and has several old convents and churches. It is the center of an important agricultural district. Population, about 15,000.

IRBY, JOHN L. M., a United States Senator; born in Laurens County, South Carolina, Sept. 10, 1854. He was educated at the University of Virginia and Princeton College, and entered the profession of law in 1876. In politics he was a Democrat, and an active member of the Farmers' Alliance. He was elected a member of the state house of representatives in 1886, 1888 and 1890. In 1890 he was elected by the South Carolina legislature to the United States Senate, to succeed Wade Hampton.

IREDELL, JAMES, an American jurist; born in Lewes, England, Oct. 5, 1751. Emigrating to America in 1768, he was admitted to the North

Carolina bar in 1775, and from 1774 until the Revolution was collector of customs at Edenton. In 1777 he was chosen a judge of the superior court of the state, and in 1787 was appointed a commissioner to compile and revise the laws of the state. The results of his work were published in 1791 under the name of Iredell's Revisions. In 1790 he became associate justice of the United States supreme court. He died in Edenton, North Carolina, Oct. 20, 1799.

IREDELL, JAMES, a United States Senator, son of the preceding; born at Edenton, North Carolina, Nov. 2, 1788. He was educated at Princeton, fought during the War of 1812, was admitted to the North Carolina bar, and in 1816 became a member of the legislature, serving for many years, being speaker in 1817 and 1818. In 1827 he became a judge of the superior court; in the same year was elected governor of the state; and from 1828 to 1831 was in the United States Senate. He afterward practiced his profession in Raleigh, and for many years was reporter of the decisions of the supreme court. He was also one of three commissioners who were appointed to collect and revise the laws in force in the state. He published a *Treatise on the Law of Executors and Administrators*, and a *Digest of All the Reported Cases in the Courts of North Carolina, 1778 to 1845* (1839-46). He died at Edenton, April 13, 1853.

IRELAND. See IRELAND, Vol. XIII, pp. 214-72; and GREAT BRITAIN and HOME RULE, in these Supplements.

IRELAND, JOHN, an American Catholic prelate; born in Kilkenny, Ireland, Sept. 11, 1838; emigrated to the United States when a child, and settled in Minnesota. On Dec. 21, 1861, he was ordained at St. Paul. After serving as an army chaplain he became rector of the cathedral at St. Paul, and in 1875 was made coadjutor bishop. He was a prominent member of the Vatican Council of 1870; engaged in the work of establishing colonies of Catholics in



ARCHBISHOP IRELAND.

Minnesota and the Northwest; and was made archbishop of St. Paul in 1888.

IRELAND AND THE IRISH QUESTION. See HOME RULE, in these Supplements.

IRIDACEÆ, a family of monocotyledonous plants, mostly herbaceous, with bulbous, tuberous, or creeping root-stocks. The leaves are generally sword-shaped and in two rows. The colored perianth is six-merous. The stamens are three, with anthers turned outward. The ovary is inferior; there is one style, with three stigmas, which are often petal-like. The fruit is a three-celled, three-valved capsule. Numerous species are known, of which the greater number are natives of warm countries, and many are in cultiva-

tion for ornament. Some of the common genera are *Iris*, commonly known as "flag," *Crocus*, and *Gladiolus*. Saffron is obtained from the stigmas of *Crocus sativus*, and "orris-root" from the root-stocks of various species of *Iris*.

IRIDOSMIUM. See MINERALOGY, Vol. XVI, p. 383.

IRISH CRIMES ACT. See HOME RULE, in these Supplements.

IRISH LAND COMMISSION. See HOME RULE, in these Supplements.

IRISH LAND LEAGUE. See HOME RULE, in these Supplements.

IRISH LANGUAGE AND LITERATURE. See CELTIC LITERATURE, Vol. V, pp. 298, 300, 302-313, 321, 322, 326, 327.

IRISH NATIONAL ALLIANCE. See HOME RULE, in these Supplements.

IRISH NATIONAL PARTY. See HOME RULE, in these Supplements.

IRISH PARTIES IN AMERICA. See HOME RULE, in these Supplements.

IRISH SEA. See TIDES, Vol. XXIII, p. 373.

IRIS OF THE EYE. See EYE, Vol. VIII, p. 821.

IRITIS. See OPHTHALMOLOGY, Vol. XVII, p. 781.

\*IRON AND STEEL. The technical and commercial changes in the iron and steel industry since 1880 have not been due mainly to any revolutionary new inventions, such as the Bessemer or the open-hearth process, or their "basic" modifications. They have been brought about by the steadily increasing application and improvement of the processes introduced twenty years or more ago, and by the erection of plants and machines embodying in most economical and effective form the principles of modern practice. Yet the results have been far greater than could be measured in 1880, thus furnishing a fresh illustration of the law that the effects of new inventions are most profoundly felt after they have become incorporated into the body of practice, and developed, perfected, modified and applied by innumerable experts. It required a hundred years to bring to fruit the seed planted by the invention of the steam-engine, or of the steam-railway. The last twenty years have proved equal to any former century in analogous developments. The space available for the present article will permit only a brief summary of the most important factors in this result.

As will be seen in the statistical tables at the close of this article, the world's product of pig-iron reached in 1895 the amount of 29,868,239 metric tons, which is nearly 15 per cent greater than the total for 1894, and double that of 1880. This increase is largely due to the increased use of steel, of which over 15,000,000 metric tons were made in 1895, as against less than 13,000,000 in any previous year. In 1874 (see A. S. Hewitt's Presidential Address, *A Century of Mining and Metallurgy in the United States*, Transactions American Institute of Mining Engineers, Vol. V, p. 172), the world's product of pig-iron was estimated at 13,260,000 tons, of which the United States furnished 18.1; Great

\* Copyright, 1897, by The Werner Company.

Britain, 45.2; Germany, 12.1; and France, 10.3 per cent. In 1889 (see Mr. Hewitt's second Presidential Address, id., Vol. XIX, p. 482), the world's product was estimated at nearly 25,000,000 tons, of which the United States produced 30 and Great Britain 33 per cent. In 1895 the totals given above are roughly divided as follows: *Iron*—United States, 32; Great Britain, 27; Germany, 19; and France, 7 per cent. *Steel*—United States, 41; Great Britain, 21; Germany, 19; and France, 4.5 per cent. The causes of this striking change in the relative standing of the leading nations lie mainly in the utilization of domestic iron-ores by the United States and Germany, due in the former case to the development of new sources of immense supply, and in the latter to the effect of the "basic" processes in rendering phosphoric ores available for the steel manufacture. The great increase in the use of steel for rails, structures and castings is not merely a replacement by that material of cast and wrought iron. The consumption of all forms of iron has been immensely augmented, and amounts, in the United States, to some three hundred pounds *per capita* annually. This enlargement of the use of iron has been the result of the cheapening of price, coupled with improvement in the quality; and for this the world is indebted to chemists, metallurgists and mechanical engineers. No more striking illustration of the benefits conferred upon mankind by science can be adduced.

*Iron-Ores.* The most important development of new sources of iron-ore supply has been in the Lake Superior region, already known as highly productive. The Menominee, Gogebic, Vermilion and Mesabi ranges have furnished since 1880 some fifty million tons of ore; and the product for 1895 (including two million tons from the old Marquette region) was more than ten million tons. The latest field is the Mesabi, which produced 4,245 tons in 1892 and 2,781,587 tons in 1895. This range is at least 40 miles long—probably longer—and promises to be much more productive than any of the others. The Marquette range is 30 miles; the Menominee, 50 miles; and the Gogebic, 30 miles long; but these distances do not indicate continuous ore-deposits. On the Vermilion range, mines are worked at two points only, 23 miles apart. Moreover, the Mesabi ore-deposits occur in beds, usually covered only by glacial "till," which can be removed by "stripping," so that the ore can be quarried, or even mined with the steam-shovel. Apart from royalty to the land-owner, the cost of mining by this method is often only 25 to 50 cents per ton. The rapid construction of railroads, docks and ore-carrying steamers has facilitated the cheap delivery of Lake Superior ores at Chicago, Cleveland, Erie, Buffalo and other lake ports; and they have been sold in competition with other domestic ores as far east as the Lehigh valley. In 1895 the Lake Superior region furnished 61.5 per cent. of the iron-ore mined in the United States.

Another important development of iron-ore, leading to the establishment of an extensive industry, has been that of the Clinton fossiliferous red hematite in the Southern states. The Clinton formation presents probably the most extensive iron-ore deposit

in the world, constituting as it does a distinct geological horizon, which ranges from Clinton, in the state of New York (whence its name), through Pennsylvania, Virginia and West Virginia, Georgia, Tennessee and Alabama. It is essentially a bed of limestone of fossil origin, which has been altered by the removal of lime and the deposition of ferric oxide, so as to form in many places a calcareous iron-ore of commercial value. (Under present conditions, 42 to 47 per cent. of iron would be the range of practically available ore.) In many localities, and very generally in depth from the outcrop, the percentage of iron is below this limit; and in the Northern states, where the bed is narrow and fluctuating, it has not been, on the whole, profitably exploited. In the South, however, and particularly in Alabama, the formation is exceptionally thick (up to 30 feet as a maximum) and easily mined, and has yielded per annum since 1889 between two and three million tons of ore to be smelted with coke from the Alabama and Tennessee fields. The ore contains too much phosphorus for the acid Bessemer-steel process; but the cheapness of mining, fuel and railway transportation has made it possible to put the Southern irons made from it into Northern markets, and even (though only to a small extent thus far) to ship them to Great Britain.

*Titaniferous Iron-Ores.* The presence of titanium (in the form of titanic acid) in iron-ores has long been recognized as a source of trouble in blast-furnace practice. There is no resulting injury to the quality of the product, for nearly all the titanic acid passes un-reduced into the slag; and the minute proportion which may appear as titanium in the pig-iron, is apparently rather beneficial than otherwise. Moreover, ores high in titanic acid are usually low in phosphorus, which does pass into the pig-iron, and is (except for special purposes) a deleterious ingredient. The practical objection to titanic acid is, that it passes into the slag, and diminishes its fusibility, thus tending to choke the blast-furnace, and to form ultimately in the hearth masses of the nitrocyanide of titanium, which it is impossible to fuse, and very difficult to remove after blowing-out. The fluxing of titaniferous ores with alumina has been practiced with partial success. But the most radical and promising remedy is that suggested by Mr. A. J. Rossi, of New York, who has succeeded in smelting such ores so as to make a fusible titanate-slag, in which titanic acid plays the part assumed by silica in ordinary blast-furnace slags. The immense deposits of such ores in the United States (to say nothing of other countries) justify the belief that their successful treatment will certainly become extensively practicable. For the present this improvement, like many others, is commercially delayed by the low price of ores generally, and the sharp competition of the pure, rich and cheap ores of the Lake Superior region. It must be remembered that, as titanic acid enters into an iron-ore largely as an isomorphic constituent, replacing the oxide of iron, high titanium is not, as a rule (though there are exceptions), accompanied with high iron; and at the present time, when 50-per-cent magnetites can scarcely be mined at a profit, titaniferous ores (which are usually hard) would have little chance to compete at the ruling market prices.

*Magnetic Concentration of Iron-Ores.* The separation of magnetite from non-magnetic minerals by means of magnets was attempted long ago, permanent horseshoe magnets being at first employed. In 1882 a machine furnished with electro-magnets was erected at Moriah, Essex County, New York, to separate magnetite from apatite. As late as 1880 magnetic iron-ore was separated from zinc-blende at Przbiram, Bohemia, with permanent magnets arranged around a wooden cylinder. In this case the zinc-blende was the desirable

product, and the iron-ore was waste. It was not until electricity could be cheaply generated by the dynamo that the magnetic concentration of iron-ore came into general use. One of the earliest successful machines was that of Jonas Wenström of Sweden. But the greatest development of magnetic concentration has been effected in the United States, where a large number of machines have been invented for this purpose. Some of the leading types are represented by the Buchanan, Conkling, Edison, Ball-Norton and Paine separators. The Edison separates by the action of a magnet on a falling stream of pulverized material. The others employ variously a traveling belt, or rolls, and are operated on wet or dry material, as the case may be. Sometimes the same machine may be employed for either class. The technical results of magnetic concentration have been, on the whole, satisfactory. But its commercial success has been hindered thus far by the prevailing low prices of iron-ore; and it may be said that hitherto there has been no profitable enterprise based on the mining of lean ore and its magnetic concentration. The present sphere of the process lies in the treatment of waste material, already mined and otherwise worthless. It has been proposed by Clemens Jones and others to roast the hydrous or anhydrous ferric oxides (himonite or hematite) so as to produce the magnetic oxide, to be subsequently separated by magnetic concentration. This has proved technically practicable; but commercial conditions have not permitted hitherto its general use. The difficulty in all such cases lies in the cost of handling and treating a material which, after all, must be sold at a low price, in competition with crude ores not subjected to that cost. A special difficulty in all magnetic concentration has been that in order to avoid loss, in the tailings, of particles of iron-ore attached to non-magnetic material, it is usually necessary to crush fine before separation, and consequently to produce, as concentrate, a fine sand or powder, which was deemed undesirable by blast-furnace managers, because it tended to produce an irregular descent of the charge, and an excessive amount of flue-dust. To overcome this objection, it has been proposed to form the fine concentrate into briquettes, with some cementing material such as lime, which would be itself useful as a flux. This operation, involving an additional expense, has not been commercially practicable under existing market conditions. Meanwhile, many furnace-men have found it practicable to use a much larger proportion of fine material in the charge than was formerly deemed practicable; and it may fairly be said that material of this class, if free from deleterious ingredients, is salable at a price dependent upon its contents in metallic iron, and not greatly, though perhaps somewhat, below the price of equally rich and pure ores delivered in the ordinary form of the "run-of-mine," that is, in lumps, with a small percentage of "fines" made in mining, handling and transportation.

A novelty in magnetic concentration is the Wetherill machine, by which so-called "non-magnetic" materials, such as franklinite, garnet, hematite, and generally minerals containing any oxide of iron or manganese, can be separated from other minerals, which are still less attracted, or are even repelled, by the magnetic pole. The theory of this separation is based on the fact that of the two classes, paramagnetics and diamagnetics, established by Faraday, the former, which are attracted by the magnet, are divided into two groups, distinguished by the degree of their magnetic susceptibility, and separated in this respect by a wide gap. One group comprises iron and its alloys, magnetite, and pyrrhotite, nickel, and some varieties of native platinum (which seem, however, to owe their magnetic properties to the presence of iron or nickel). These substances are visibly attracted by the ordinary hand-magnet. The other group is so weakly attracted as to be popularly considered non-magnetic. The gap between the two groups may be estimated by the fact that, according to the careful experiments of Plücker (*Pogg. Ann.* LXXIV, 1848) the force of magnetic attraction for iron being taken as 100,000, the attraction for magnetite is 40,227; while the highest attraction found in the second group, that of compact specular iron ore, is only 761. Since Plücker

found the attraction of prepared ferric oxide to be but 500, it is not improbable that his specular iron-ore (though theoretically anhydrous ferric oxide) contained some magnetite. In any event, the gap between 40,227 and 761 is wide enough to justify the usual treatment of the latter class as non-magnetic. The Wetherill machine, by effecting an extreme condensation of the magnetic lines at the pole-points, attracts these "non-magnetic" paramagnetics, and thus effects a separation of franklinite, garnet, hematite, limonite, siderite, pyrolusite, etc., substances not hitherto thus separated. The process has been successfully practiced at Bethlehem, Pennsylvania, on the ore of the Lehigh Zinc and Iron Company (franklinite, garnet, zinc silicates and calcite), and experiments with many iron-ores, especially with the Clinton fossils-ores of Birmingham, Alabama, have resulted favorably.

*Blast-Furnace Practice.* The astonishing progress of the last few years in this department is indicated, in one aspect at least, by the increased production per furnace, the largest records thus far made for a single stack being 12,800 gross tons in a month, 3,240 tons in a week and 526 tons in a day. These were made by different furnaces at different times, but all with Lake Superior ores and coke and in the production of Bessemer pig.

A more significant expression of this progress, however, is found in the increase of the average product per furnace. In the United States (which has taken the lead in this respect) the average yearly product of a blast-furnace was, in 1874, 6,298; in 1880, 9,369; and in 1895, 44,953 metric tons. The table exhibits in a striking manner the steady increase of furnace capacity, independent of fluctuations in trade, and the decrease in the total number of furnaces, indicating that the smaller ones of former type have been abandoned, under the pressure of competition. In other countries the change has not been so great. In Germany the product (1895) per furnace was about 28,840 metric tons; in Great Britain (1895), 23,319 metric tons. But these figures still indicate an important advance.

This result has been achieved by many co-operating agencies, chief among which are the enlargement of blast-furnaces, the employment of larger quantities and higher pressures and temperatures of blast, and, consequently, more rapid driving. Incidentally it has been necessary also to improve the material and construction of walls and hearth, and to provide for the handling of the increased amount of raw material and product involved in the new practice. Moreover, an exact knowledge of the chemical constituents of ore, flux and fuel, and of the nature of the reactions which they undergo in the furnace, has become more important than ever, because the quantity of material in the furnace at a given time, and to be affected by any irregularity in its operation, is so much greater than formerly. Constant chemical analysis of ore, flux, fuel, slag, furnace-gases and product is therefore required, especially when the pig-iron is to be used in the Bessemer converter. Among the arrangements for cheapening the handling of materials is the automatic hoist and charger, which elevates the charge to the top of the furnace, and deposits it in the stack, doing away with the labor of the "top-fillers." For the lining of the hearth and even of the bosh, carbon bricks, composed of coke and clay or coke

and tar, have been used with advantage, in both Germany and the United States. The efficacy of carbon as a protection against the fusion of fire-brick linings was shown before its intentional use for that purpose by the effect of the natural deposition of carbon on furnace-walls. Mr. James Gayley, of Pittsburg, Pennsylvania (*The Preservation of the Hearth and Bosh-Walls of the Blast-Furnace*, Transactions American Institute of Mining Engineers, vol. 21, 1893, p. 102), says that simultaneously with the commencement of the smelting operation there is deposited on the walls a coating of carbonaceous material, which, as the process advances, replaces the brick to the depth of several inches. This formation is promoted by the presence of basic cinder in the bosh.

Additional protection is given to hearth and bosh-walls by water-cooling. Cooling-plates and tuyères have been advantageously made of bronze. Mr. Gayley says that before the introduction of bronze plates the usual experience as to fuel-consumption was a minimum quantity at the commencement of the blast, gradually increasing until at the end it was abnormally high; but where the walls are equipped with bronze cooling-plates, it is a common experience that the fuel-consumption shows very little increase at the end of the blast. The first cost of bronze plates and tuyères is somewhat greater than that of iron ones; but the difference is covered many times over by increased economy. The material can, of course, be recast when worn out.

Edgar Thomson furnace A, near Pittsburg, which was erected and put in blast in 1879, is recognized as the pioneer in the new practice, and as such has become famous throughout the world. Its regular yield of 650 tons per week was regarded with astonishment, in view of its small dimensions (66 feet high by 13 feet bosh). But the succeeding furnaces of the same company followed in rapid succession, each eclipsing its predecessor in output, until 1,400 to 1,500 tons per week was a regular average, and this amount has now been more than doubled. The preservation of linings has been so successfully effected at the same works that over 400,000 tons of pig have been made on a single lining. It has thus been demonstrated that the American method of rapid driving does not involve, as foreign critics once believed it did, a ruinous destruction of the furnace. The principal remaining question is that of fuel-economy. In this respect, also, the furnaces making the highest records of product have taken the lead. In November, 1887, the four furnaces at South Chicago made 23,530 tons of pig with a consumption of 1,834 pounds of coke per ton. In 1892 a furnace of the Illinois Steel Company, at Milwaukee, Wisconsin, showed a fuel-consumption (best month) of 1,824 pounds of coke per ton of pig-iron.

Fig. A, showing the lines of Edgar Thomson furnace F, built in 1886, may serve as a type of modern construction.

The foregoing statements apply to furnaces using the rich and easily-reduced Lake Superior ores, with coke as fuel. But anthracite and charcoal furnaces exhibit a similar though less startling progress.

E. C. Potter (*Review of American Blast Furnace Practice*, Transactions American Institute of Mining Engineers, Vol. 23, 1893, p. 379) describes the Hinkle furnace in Wisconsin, 60 by 12 feet in size, as having made in a single week 1,009 gross tons of iron on 80 bushels (of 22 pounds) of charcoal to the ton. The Warwick (anthracite) furnace, Pennsylvania, as rebuilt in 1889, 70 by 16 feet, and 8 feet 9 inches hearth-diameter, had made in 1890 (ib., Vol. XIX, p. 967) forty thou-

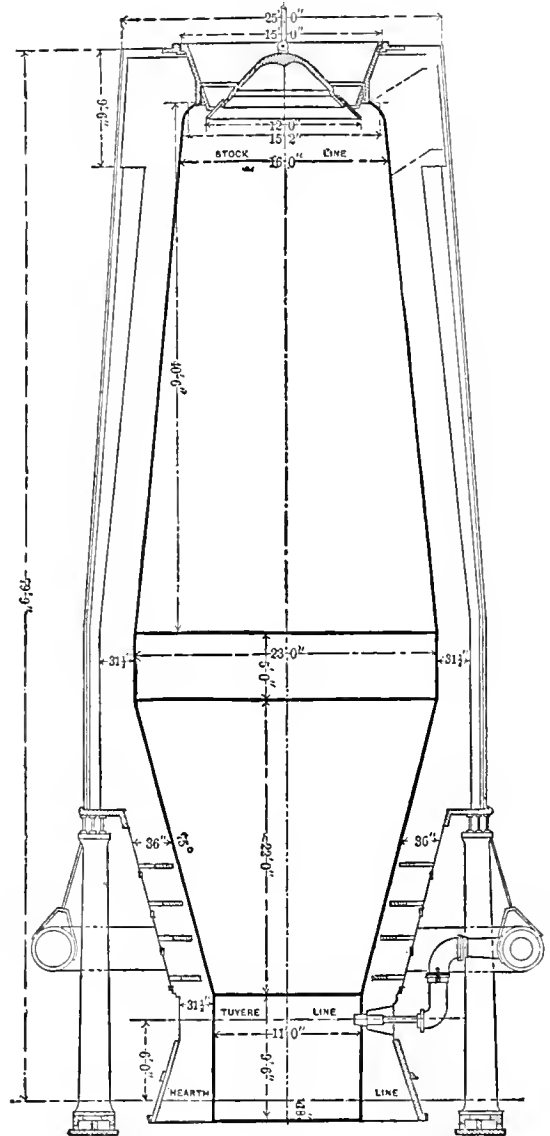

FIG. A.

sand tons of pig, with an average fuel-consumption of 2,464 pounds (one fourth coke and three fourths anthracite) per ton of iron. Best week, 873 tons; lowest fuel for five consecutive weeks, 2,268 pounds per ton.

Interruptions in operation are much more injurious under the modern system, both technically and commercially, than they were before. Thus the ancient practice of an open fore-hearth, to be cleaned out at every cast, with a loss of two to four hours in

twenty-four, has long been abandoned; and the principle of the Lürmann closed front and water-cooled cinder-tap has become universal. Another characteristic feature of modern American rapid-running blast-furnace plants is the avoidance of such concentration of motive power or function as would, in case of accident, involve the stoppage of the whole or a large part of the plant. Each furnace is built and operated separately, having its own blowing-engine (or, still better, two or three engines instead of one), hoist, hot-blast stoves, etc., and cross-connections are provided, so that in a plant of two or more furnaces any engine or stove may be applied to any furnace. Each boiler, or pair of boilers, has its own chimney, and can be fired independently with solid fuel if furnace-gas fails. A separate chimney for each stove is also favored, instead of one large chimney for the whole plant. The separate chimney is a feature of the Durham iron stove, designed by Edward Cooper, and has proved so advantageous in that apparatus as to warrant its adoption in a number of the latest types of brick stoves.

That uniform quality of product has been secured by the new practice, is indicated by the fact that the largest productions named have been of Bessemer pig.

*Foundry Practice.* The most significant advance in this department, during the last fifteen years, has been the increasing utilization of chemical analysis to control the operations of the iron foundry, and particularly the choice of pig-irons for castings. The ancient practice (not yet wholly extinct) was to employ certain irons or mixtures, empirically shown to give the special results desired. The irons so selected were made from certain ores, in a certain way, were presumed to be uniform in quality, and often commanded, on this account, an extra price. The most important instance, perhaps, was the universal exclusive use of charcoal-pig for the manufacture of cast-iron car-wheels, which would "chill" in casting, so as to give at the rim a hard surface, resisting wear, while they retained strength and toughness in the interior mass. This tradition was rudely broken by the chemists, who traced the "chilling" property to a certain composition of the pig-iron, and taught the blast-furnace managers to make, with fuels cheaper than charcoal, iron which could be successfully used, alone or in mixture, for car-wheel castings. The action of railroad companies, steel manufacturers and other large consumers, in buying pig-iron on chemical specifications, has led to the general employment of chemists at blast-furnaces, and the pressure of similar conditions has finally affected the iron foundries; so that it is now a not uncommon practice in the latter business to choose or mix irons for a desired result according to their chemical composition. Physical tests of the pig-iron as to strength, shrinkage, etc., are also taking the place of the old method of judging by the "grain," as shown on a fractured surface of the pig. There are also indications of a further advance in practice, consisting in the treatment of the liquid metal, to alter its composition. The feasibility, for instance, of making "No. 1 foundry-iron" out of lower grades by the addition of ferro-silicon in the ladle, is established; and it is not improbable that the quality of the blast-furnace product may ultimately come to be of relatively smaller importance in the foundry, so that the cheapest pig-iron may be employed for castings, being corrected in composition at the foundry. For the present, the relative cheapness of pig-iron of high quality supersedes the necessity of such improvements. That is to say, the price of the best foundry pig is, in most cases, not sufficiently greater than that of inferior grades to warrant the special extra treatment of the latter.

In connection with iron castings, Mr. A. E. Outerbridge,

Jr., has published the interesting discovery (*Transactions American Institute of Mining Engineers*, vol. 26) that they are materially strengthened by subjection to repeated light shocks or blows. His experiments included the treatment of castings in a "tumbling-barrel," used to clean the sand from their surfaces, and also the treatment of six cast-iron bars by striking each, upon one end only, three thousand times with an ordinary hand-hammer. Subsequent tests showed a considerable gain in tensile strength (in one case, nearly nineteen per cent) for the bars thus "tumbled" or hammered. Mr. Outerbridge ascribes this result to a mobility of the molecules. He says: "All that is claimed is, that every iron casting, when first made, is under a condition of strain due to difference in the rate of the cooling of the metal near the surface, as compared with that nearer the center, and also to difference of section; and further, that it is practicable to relieve these strains by repeatedly tapping the casting, thus permitting the individual metallic particles to rearrange themselves, and assume a new condition of molecular equilibrium."

*Hydraulic Presses.* A highly important development in the treatment of malleable metal has been the progressive substitution of the hydraulic press for the hammer. The superior economy of the press is evident. It saves both power and time. The hammer operates by blows, and its energy depends upon the final velocity of its fall; whereas in the press this velocity is so small that it plays no part in the effect. But the greater the velocity of the hammer, the less time is given for the transfer of its effect from the surface to the interior of the mass under treatment; and, in consequence, much energy is lost in mere useless jarring of die and foundation. This loss is the greater the larger the mass to be forged. Moreover, there is a loss of time, and consequently of labor, through the intermittent action of the hammer; and, finally, it is now generally admitted that the effect of slow compression upon the structure of large masses is superior to that of percussion, though the latter is still often preferred for comparatively small masses, like loops and blooms, from which slag is to be expelled. It is an incidental evil of the hammer that it produces a change of form, even when its blow is too light to affect the whole mass. In such cases the surface only is affected, and not the structure. The consequent lack of uniformity in the compression of the metal has been the cause of many fractures of hammer-forged steel. Fig. B illustrates the press built by the Bochum Company, in Westphalia, and Fig. C the Whitworth press, designed for the compression of steel in the ingot-mold, at Bethlehem, Pennsylvania.

Howe (*Metallurgy of Steel*, 1st ed., p. 156) says the pressure on the steel is gradually increased, usually till it reaches six tons, occasionally twenty tons, per square inch of the horizontal section of the ingot. In 1893 a 14,000-ton armor-plate press was started at the Bethlehem Iron Company's works, giving 7,000 pounds of hydraulic pressure per square inch, and operated by pumps of 16,000 horse-power.

*Mannesmann Tubes.* The invention of the brothers Mannesmann, of Reuschel, Germany, effects the direct rolling of metal tubes without welding. This is done by feeding a solid, highly heated round bar of ingot-metal between rolls which both revolve in the same direction while their axes are oblique to the axis of revolution. The metal of the surface of the bar thus acquires an increased motion in a spiral direction, and is drawn over

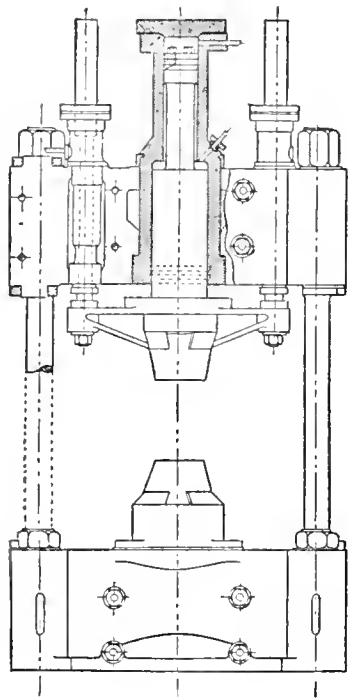

FIG. B.

*Whitworth Press for Steel Ingots.* A, press-cylinder; B, hydraulic plunger; C, wagon, bringing ingot-mold under the press; D D, four hollow columns, connecting A with movable cross-head E, which is lifted by hydraulic plungers, and held to the columns D by the nuts F; G, boss, closing the ingot-mold when pressure is applied from below to the liquid steel; H, indicator, showing the rise of the main plunger, B; I I, split stops, to support the main cross-head when the press is not in use; K K, steel jackets for mold; L L, mold; M M, perforated cast-iron lagging; N, inner sand lining.

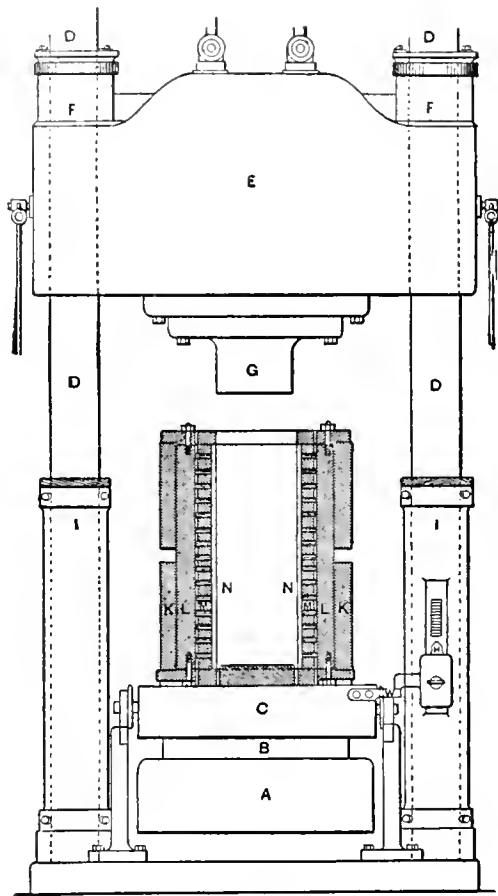

FIG. C.

its core, receiving consequently the form of a pipe. The interior space thus created can be widened, if necessary, by further operations over a mandrel. Pipes thus made and enlarged have been produced of all diameters up to 400 mm. They are specially characterized, not only by their strength, but by their freedom from leakage. On the latter account, they are recommended (see the remarks of Professor Lunge on the paper of Professor Wedding, in *Transactions American Institute of Mining Engineers*, Vol. 19, 1890, p. 397) for making high-pressure vessels to store and carry liquid carbon-dioxide, ammonia, sulphur-dioxide, chlorine, compressed oxygen, hydrogen, etc. Hydrogen has been kept for weeks in a piece of Mannesmann pipe, closed at both ends. Being much stronger than ordinary wrought-iron or steel tubes of the same weight, they can be made correspondingly lighter, thus removing an objection which has been, in some cases, prohibitory of the commercial supply of the substances named. The Mannesmann tubes are now extensively used in the manufacture of bicycles.

For ELECTRIC WELDING, see WELDING, in these Supplements.

*Microstructure of Steel.* In this department an immense amount of interesting and important investigation has been performed during recent years by Sorby, Arnold and others in Great Britain; Osmond, Le Chatelier, Müller, Wedding, Martens and

others in Europe, and Howe, Sauveur and others in the United States. It is not possible to give here more than a bare outline of the results, following generally the summary given in the latest paper on the subject, by A. Sauveur of Chicago (*Transactions American Institute of Mining Engineers*, vol. 26, now in press). All carbon-steels, whether quenched or slowly cooled, are made up of one or more of the following constituents, recognizable under the microscope: Ferrite (iron free from carbon); cementite (iron combined with cement-carbon, *i.e.*, carbon as it exists in unhardened steel, and constituting a carbide, Fe<sub>3</sub>C); pearlyte (a mixture of ferrite and cementite, sometimes granular and sometimes lamellar, the latter variety having a pearly appearance); and martensite (the constituent which exists at a high temperature, and, being retained by sudden cooling, confers hardness upon quenched steel). Of these names, the first three were proposed by H. M. Howe and the fourth by F. Osmond. They have not been universally accepted (Arnold, for instance, objects to giving special names in the present stage of inquiry); but they are convenient for a brief statement. The composition of ferrite, cementite and pearlyte



is known with reasonable certainty. Of that of martensite there is no direct proof. If its composition were positively known, the problem of the hardening of steel would be solved. Meanwhile, every theorist on hardening attributes to martensite the composition demanded by his theory. It contains carbon, but not in definite proportions, like pearlyte, the amount varying from 0.12 per cent in very soft to 0.90 in very hard steel. All unhardened steels are composed of pearlyte alone, or pearlyte associated with ferrite or cementite. All hardened steels are composed of martensite alone, or martensite associated with ferrite or cementite. M. Osmond (*Méthode Générale pour l'Analyse Micrographique des Aciers au Carbone*, Paris, 1895) distinguishes two other constituents, which he calls sorbite and troostite. They seem to be merely transition-forms, having but brief existence during the structural changes induced in steel by heat treatment, the former coming between ferrite and cementite, and the latter between ferrite and martensite. In unhardened steel, the carbon present unites with a portion of the iron to form cementite,  $\text{Fe}_3\text{C}$ , which contains 6.67 C to 93.33 iron. This cementite combines structurally with an additional amount of iron, in the proportion of 12 cementite to 88 iron, forming pearlyte; and the remainder of the steel is made up of structurally free ferrite. It is thus possible to calculate approximately the physical constitution of any unhardened steel of which the percentage of carbon is known, bearing in mind that if the steel contains more than a certain amount of carbon, there will be free cementite, instead of free ferrite, in excess. At that point (called by Professor Arnold the saturation-point of steel) there will be neither free ferrite nor free cementite, but the steel will consist of pearlyte only. The calculation, however, is affected by other ingredients present, besides carbon and iron. Thus Arnold finds the saturation-point for the nearly pure carbon-alloy to be about 0.90 per cent of carbon, at which point, and not before, all structurally free ferrite has disappeared; while Sauveur finds that in commercial steels, containing from 0.4 to 1 per cent of manganese and 0.75 to 1.25 per cent of total impurities, the saturation-point is very near 0.80 carbon.

The behavior of steel under heat-treatment, involving the formation and effects of martensite, presents a more intricate and doubtful problem. If a piece of steel containing 0.5 per cent or more of carbon be heated to a high temperature and allowed to cool slowly, there is, at about 700° C., a retardation in the progressive fall of its temperature, often amounting to a sensible recalescence, after which the normal rate of cooling is resumed. This must indicate some internal reaction, evolving heat, and the point of temperature at which it occurs (first determined accurately with the Le Chatelier's pyrometer, by Osmond) is called a critical point and designated (according to Chernoff's nomenclature) by the letter A. In heating steel, the reverse occurs. There is a point at which the rise of temperature is retarded, doubtless by some internal reaction which absorbs heat. The two retardations do not, however, take place at exactly the same temperature, and the critical points are therefore distinguished as  $A_r$  for cooling and  $A_c$  for heating.  $A_c$  is about 30° C. higher than  $A_r$ . The one is, however, practically the correlative of the other. Osmond and Howe have shown that by hastening the cooling, the critical point  $A_r$  is proportionally lowered until, when

the cooling is (as in quenching) sufficiently rapid, there is no retardation; the change  $A_r$  does not take place. Hence certain conditions which existed above  $A_r$  are retained by quenching; and to this retention the various theories attribute the hardness of quenched steel. It is with regard to the nature of what is thus retained that they differ. The theoretical investigation is still further complicated by the discovery that, while high-carbon steels and those of medium hardness exhibit in heating and in cooling only one critical point, soft steels present two, or even three, which are distinguished as  $A_r^1, A_r^2, A_r^3$ , and  $A_c^1, A_c^2, A_c^3$ ; the latter being, as in hard steel, the correlatives of the former. Certain accessory constituents, especially manganese, nickel, chromium and tungsten, lower the critical points decidedly. Manganese and nickel, when present in sufficient quantity, apparently eliminate them (probably by lowering them below atmospheric temperature, and thus beyond observation). Ingeniously measuring in the micrograph the proportion of each constituent in the section, Sauveur has shown that in carbon-steel heated beyond  $A_c^1$  the iron and carbon unite during  $A_c^1$  to form martensite containing up to 200 iron for 1 carbon. Hence if the steel contains more than 0.50 carbon, the whole of the iron will be thus combined, and no other critical point or structural change is noted in further heating. As martensite never contains more than 0.90 per cent of carbon, some structurally free cementite will be found. On the other hand, if the steel contains less than 0.50 carbon, some iron will remain above  $A_c^1$ , as structurally free ferrite, and on further heating there is a second retardation,  $A_c^2$ , during which the saturation-point is raised to 1 carbon: 400 iron, additional ferrite is absorbed by the martensite, and a new structural equilibrium is established. For steel containing less than 0.50 and more than 0.25 carbon,  $A_c^2$  causes all free ferrite to disappear; and such steel has no third critical point. But steel containing less than 0.25 carbon leaves some ferrite still unabsorbed above  $A_c^2$ , and has a third critical point,  $A_c^3$ , which raises the saturation-point to 1:800, and enables additional ferrite to be absorbed by the martensite. If more than 0.12 per cent of carbon is present, all the ferrite disappears; if less, some ferrite will remain unabsorbed beyond  $A_c^3$ . The reverse phenomena occur during slow cooling at  $A_r^3, A_r^2$  and  $A_r^1$ ; the ferrite which was absorbed at  $A_c^3$  and  $A_c^2$  being set free at  $A_r^2$  and  $A_r^3$ , while at  $A_r^1$  the martensite is replaced by pearlyte.

The two main theories of hardening have been the carbon theory, which assumes that at and above a certain critical range (Osmond's A) the carbon passes spontaneously from its normal condition (cement-carbon) to a special condition (hardening-carbon); and the allotropic theory, which assumes that the iron under these conditions passes from its ordinary (*alpha*) condition to a strong, hard, brittle, allotropic (*beta*) state.\* The hardening carbon of the one theory and the  $\beta$  iron of the other return under slow cooling to their former states, but may be preserved by sudden cooling. Mr. Howe has suggested (*The Hardening of Steel*, Journal of Iron and Steel Institute, No. 2, 1895) that the hardening of steel is due to the existence, at a high temperature, and the retention by sudden cooling, of a carbide of an allotropic form of iron. This he calls the carbo-allotropic theory. Prof. Arnold (*On the Influence of Carbon on Iron*, Proceedings Institute of Civil Engineers, Vol. 123, London, 1896) attributes the hardening, not to the carbon as such, but to the existence, above the critical range, of a very attenuated and very hard carbide of iron. This Sauveur calls the sub-carbide theory, and sums up the views and evidence advanced for each theory in the table here given, with which the present sketch of the subject must conclude.

*Steel Manufacture.* The revolution which has taken place in the relative use of cast and wrought iron and steel or ingot-iron affects also the relations of the different kinds of the latter (acid or basic Bessemer and open-hearth; crucible steel). The great change consists in—(1) the universal

\* In the table below, a third form (*gamma*) is designated, being the martensite of steel cooled above  $A_r^2$ .

## THEORIES OF THE HARDENING OF STEEL.

	CARBON THEORY.	ALLOTROPIC THEORY.	CARBO-ALLOTROPIC THEORY.	PROF. ARNOLO'S SUB-CARBIDE THEORY.		MICROSTRUCTURAL EVIDENCE.
Conditions of carbon and iron above $A^3$ .	Iron and hardening-carbon.	Carbon diffused in $\gamma$ iron.		Carbon and iron combined as $Fe^{24}C$ .	?	Very mild steel, made up of martensite and ferrite.
Cause of the evolution of heat at $A^4$ .	?	Passage of the iron from the $\gamma$ to the $\beta$ state.		Dissociation of $Fe^{24}C$ .	Formation of $Fe^{24}C$	Separation of a certain amount of ferrite previously included in martensite.
Conditions of carbon and iron between $A^3$ and $A^2$ .	Iron and hardening-carbon.	Carbon diffused in $\beta$ iron.		?	Carbon and iron combined as $Fe^{24}C$ .	Soft and medium hard steel made up of martensite and ferrite.
Cause of the evolution of heat at $A^2$ .	?	Passage of the iron from the $\beta$ to the $\alpha$ state. Steel become magnetic.		Passage of iron from a plastic to a crystalline condition.		Separation from the martensite of an additional amount of ferrite.
Conditions of carbon and iron between $A^2$ and $A^1$ .	Iron and hardening-carbon.	Carbon diffused in $\alpha$ iron.		?	Carbon and iron combined as $Fe^{24}C$ .	Soft steel: martensite and ferrite. Medium hard steel: martensite. Hard steel: martensite and cementite.
Cause of the evolution of heat at $A^1$ .	Passage of carbon from hardening to cement-state.	Carbon combining with $\alpha$ iron to form $Fe^3C$ .		Carbon combined with iron to form $Fe^3C$ .	Dissociation of $Fe^{24}C$ and formation of $Fe^3C$ .	Disappearance of martensite and appearance of pearlyte.
Conditions of carbon and iron below $A^1$ .	Iron and cement-carbon combined as $Fe^3C$ .	Iron and cement-carbon combined as $Fe^3C$ .		Iron and carbon combined as $Fe^3C$ .		Soft steel: pearlyte and ferrite. Hard steel: pearlyte and cementite.
Cause of hardening.	Retention by sudden cooling of the carbon in its hardening state.	Retention by sudden cooling of a hard allotropic state of iron, which retention is helped by the presence of C.	Retention by sudden cooling of a hard carbide of $\gamma$ or $\beta$ iron.	Retention by sudden cooling of a hard sub carbide of iron $Fe^{24}C$ .		Retention of the martensite by sudden cooling.

substitution of strong, durable and cheap Bessemer rails for those of iron; (2) the immense extension of the use of Bessemer steel in other directions, as a substitute for puddled and refined iron; (3) the successful establishment of the open-hearth manufacture for boiler-plates, sheets and all manner of "mild" steels, in which uniformity of quality is most important; (4) the development of the basic open-hearth process for the production of a metal superior for finer uses to other Bessemer or open-hearth steels, and less costly than crucible steel; (5) the successful production of steel castings. The basic Bessemer process has been chiefly advantageous to English and European makers by enabling them to utilize phosphoric ores. But the quality of the product has not been so much better than that of the acid Bessemer as to command additional fields of use. The reason, as stated by William Metcalf (*Eng. Mag.*, New York, Vol. IX, 1895, p. 1075), is that the two processes are subject in common to certain limitations, such as the absence of power to manipulate beyond very narrow limits (overblowing and underblowing being beyond adequate and convenient remedy). Moreover, the basic Bessemer requires phosphorus in the pig-iron as a source of heat; and the afterblow is liable to be carried a little too far. In the basic open-hearth, on the other hand, the source of heat being extraneous, it is not necessary to introduce phosphorus as a fuel; and the operation is so continuously under control that phosphorus in the charge can be eliminated to a considerable degree before the carbon has been burned out, so that it is possible to produce steel containing 1 per cent or more of carbon and less than 0.05 phosphorus,

from a charge containing 0.10 phosphorus. And this can be done, practically without recarburizing, by "melting down" to the required percentage of carbon. Mr. Metcalf says this fact has given the basic open-hearth an enormous field of usefulness not successfully occupied by the Bessemer, and previously belonging in large degree to the crucible, which is now greatly narrowed in application, and limited to the finer requirements of the arts. "It will hold this field until future developments shall remove the last elements of weakness from the cheaper processes. When that time comes, crucibles will be used no longer for making steel." Yet the puddling-furnace, the extinction of which was prophesied before 1880, "dies hard." The British product of puddled-bar in 1894 was 1,148,012 tons, against 1,535,225 tons of Bessemer ingots and 1,724,737 tons of open-hearth ingots; and 1,775 puddling-furnaces were still running in Great Britain.

*Bessemer Steel.* Important mechanical improvements have been introduced in the plant and machinery of this process, such as the casting of the ingots in moulds, which stand on cars, instead of in a casting-pit. The stripping and removal of the ingots can thus be performed with greater ease, in a cool and convenient space, and "sticking" ingots can be extracted by machinery. Another improvement is the pig-mixer, used at those works in which the fluid iron from the blast-furnace is conveyed to the converter. This is a large, brick-lined, tipping reservoir, into which the iron from several furnaces is poured, so as to equalize variations in its composition. Mixing is promoted by rocking the reservoir and by thrusting into the molten metal a

wooden pole, which, being destructively distilled, gives off gas copiously, stirring up the mass. The result is greater uniformity in the composition of the steel, a smaller production of scrap and greater convenience in the supply of metal to the converters, since iron from the furnaces can be kept hot in the mixer until required. Moreover, the iron itself may be improved in the mixer by the elimination of sulphur, either through simple standing or by the addition of manganese or manganiferous iron (Hilgenstock's process, which is said to reduce 0.50 to 0.05 per cent of manganese), or of chloride of lime with lime or limestone (the Saniter process, used at Wigan).

The Darby process of carbonization with solid carbon, is a means of restoring carbon to the decarburized metal without introducing an undesirable quantity of manganese. (See Ledebur's *Handbuch der Eisenhüttenkunde*, 1895, Vol. III, p. 920; also *Stahl u. Eisen*, 1890, p. 925; and A. Thielen, *The Darby Process of Recarburization*, *Transactions American Institute of Mining Engineers*, Vol. XIX, p. 790). It is applied to both acid and basic Bessemer, or open-hearth metal, by simply feeding ground coke to the ladle containing it. This does away with a large part of the spiegeleisen otherwise required, and effects, besides this economy, a considerable increase in the certainty of control over the composition of the final product.

*Soaking-Pits.* The desirability, both on account of economy in fuel and also of the quality of product, of rolling steel ingots without reheating, is now admitted. Stead showed experimentally that the margin of heat is ample. If the highest heat required for rolling an ingot and given to it in a heating-furnace be represented by 100, the heat in the fluid steel, as poured into the ingot-mould, is 150. But the difficulty of utilizing this heat was long deemed insuperable. The original practice was to let the ingots become quite cold, and then reheat them for the rolls. It was supposed that good work could not be done otherwise. Afterward it was found quite practicable and economical to put the ingots as hot as possible into the heating-furnaces, in which their temperature was not merely raised, but equalized. The soaking-pit, invented by John Gjers, of Middlesborough, England, effects an equalization and preservation of the initial heat, and puts the ingots in a condition suitable for rolling without the intervention of a heating-furnace. It is a vertical cell, lined with brick or other refractory material, in which the ingot is placed as soon as possible after it has been stripped of its mould. This cell is previously heated by gas-firing; when, however, the brickwork of the pits has become thoroughly heated and the operation of preparing ingots goes on continuously, there is no need of extraneous heat. The loss of heat being very slow, the excess from each ingot, which passes into the surrounding brickwork, makes it nearly as hot as the ingot itself. Hence the heat of the interior will tend to be distributed throughout the mass. Whatever be the surface-heat, however, the ingot will always be hotter inside, which is the reverse of what happens in the furnace-heating of a comparatively cool ingot.

The use of fired and unfired soaking-pits has rapidly increased in Great Britain and Europe; but it is not general in the works of the United States.

*Mechanical Conveyors.* In the Bessemer, as in the open-hearth and the blast-furnace practice, there has been an immense extension of the use of machinery to handle the larger quantities and masses now involved. Electric, as well as steam and hydraulic power, is applied to cranes, carriages, locomotives, feeders, etc.

*Open-Hearth Steel.* The principal improvements in this branch have been in the enlargement and better construction of furnaces (e.g., the Batho and the Lash furnaces; see A. E. Hunt's *Recent Improvements in Open-Hearth Steel Practice*, *Transactions American Institute of Mining Engineers*, Vol. XVI, p. 963, and a paper by H. H. Campbell, *ib.*, Vol. XXII, p. 345), the use of natural gas as fuel, the employment of a wider range of raw materials, and the accompanying increase in accuracy of chemical control and in facilities for mechanical handling. Among the improvements in this line is the use of the large tipping open-hearth furnace. Six of these, at Steelton, Pennsylvania, each having the capacity of 100,000 pounds of ingots per cast, are all commanded by a 75-ton electro-hydraulic crane. The furnaces can be lined with either acid or basic, and have been successfully operated in both ways. Open-hearth furnaces of 30 and 40 tons' capacity are now common, and "the reproach of the open-hearth process, its small output, is to disappear." (H. M. Howe, *Certain Advances in Iron and Steel Metallurgy*, and H. H. Campbell, *The Open-Hearth Work at Stulton*, both in Rothwell's *Mineral Industry*, Vol. II, 1894.)

The basic open-hearth process commands the widest range of materials, and permits the most effective control of product. Krupp, of Essen, produced in 1895 basic open-hearth metal containing—

	PER CENT.
Iron .....	99.710
Manganese .....	0.079
Nickel and cobalt .....	0.039
Copper .....	0.068
Silicon .....	0.013
Carbon .....	0.070
Sulphur .....	0.013
Phosphorus .....	0.007
Total .....	99.999

(See *Journal Iron and Steel Institute*, 1895, No. 2, p. 151.)

The process is therefore able to compete with the crucible on the one hand and the puddling-furnace on the other; and its consequent rapid extension has involved the employment of large plants and heavy machinery, such as are required by the Bessemer process. Indeed, the handling of a charge of forty or fifty tons of liquid steel exceeds in difficulty anything called for in Bessemer practice.

The open-hearth is also specially available for the manufacture of special steels, of which several are mentioned below.

*Basic Slags.* An incidental advantage of the basic processes for the manufacture of steel is the commercial utilization, as a fertilizer, of the slag

produced. This is more particularly and generally true of the basic Bessemer slag, because that process necessarily involves the use of pig-iron high in phosphorus; whereas the basic open-hearth process, being conducted with the aid of extraneous heat, does not require phosphorus as a heat-generating constituent of the charge, and may therefore yield a slag not rich in this ingredient. The basic Bessemer slag produced at Pottstown, Pennsylvania, averaged per cent 21.37 phosphoric acid and 45.26 lime. In Great Britain and Europe, all the slag of this character is used as a fertilizer, and it is estimated that over 7,000,000 tons have been thus consumed. For this purpose the slag is ground very fine (usually with ball-pulverizers), and applied to the soil in its crude condition, without chemical treatment (such as is given to the fossil phosphates) to convert the phosphoric acid into soluble form. According to the statement of Mr. W. H. Morris, of Pottstown (*Transactions of American Institute of Mining Engineers*, Vol. XXI, p. 232), the grinding is carried so far that at least 60 per cent of the material will pass through a 150-mesh screen, and 90 per cent through a 100-mesh screen. This fine grinding is apparently the main condition of successful use. From the material thus prepared, the phosphoric acid is taken up by the soil, though not as rapidly as the more soluble phosphates produced by chemical treatment. The effect, however, is believed to be proportionally more lasting. This fertilizer is reported in Germany to be best adapted to sandy, silicious and peaty soils. Being essentially a waste product, it is sold at low prices, and thus commands a market in the face of all competition from mineral phosphates or guanos, which have to bear the entire cost of mining and preparation.

*Manganese-Steel.* The importance of manganese in the manufacture of iron and steel has been long recognized. Metallurgical practice takes into account its effect upon the absorption of carbon, the formation of graphite, the contents of sulphur, the temperature of fusion and the hardness and strength of cast-iron, and upon the structure, malleability, weldability, etc., of wrought-iron: the part which it plays in puddling and refining; its value in the crucible-process, and as a minute admixture in crucible and other steels; and, above all, its operation as a deoxidizer when added as spiegeleisen or ferro-manganese to the steel produced by the Bessemer or the open-hearth process, a function which, in the former process at least, is essential to success. But all these instances involve but an extremely small percentage of manganese, either in the course of the process or in the final product; and none of them can be said to foreshadow the qualities of an alloy of iron in which manganese is a principal ingredient to the amount of more than, say, 1.25 per cent. According to Mr. R. A. Hadfield, of Sheffield, England, the introducer of commercial manganese-steel (see *Transactions American Institute of Mining Engineers*, Vol. XXIII, p. 148), ordinary carbon-steel, whether cast or forged, may contain as much as 1.25 per cent of manganese without showing any marked change in quality, provided the carbon is low. But after this point is passed there is a decrease in strength

and ductility; and somewhere between 3.5 and 5 per cent of manganese an exceedingly hard and brittle material results. Beyond about 6.5 per cent a remarkable change occurs, and toughness and ductility gradually return. The alloy becomes also less and less subject to magnetization, and at 13 per cent is practically non-magnetic. At about 14 per cent the maximum of strength is reached for cast manganese-steel, as practically manufactured (i.e., with the use of ferro-manganese, which inevitably introduces carbon). A reduction in carbon would probably permit the manganese to be increased without loss of strength, but is, on other accounts, not desirable. Forged manganese-steel is most brittle at about 5 per cent. At 10 per cent, when water-toughened, it exhibits the ductility of mild carbon-steel, but much higher tenacity. At 13 per cent there is a considerable increase, both of tenacity and ductility. At about 22 per cent malleability ceases. There seems to be no commercial advantage in manufacturing either cast or forged manganese steel containing more than 14 per cent of manganese. The carbon usually ranges from 1 to 1.3 per cent. Tests of the forged steel, made by disinterested authorities, indicate the qualities of the metal. (See Hadfield's paper, already cited.) The specimens were water-toughened, and showed: limit of elasticity, 19.8 to 29.9 tons per square inch; breaking-strain, 58.8 to 73.8 tons; elongation, 39 to 49 per cent; reduction of area, 34 to 45 per cent. These figures are here given approximately, exceptions due to special treatment being disregarded. Professor Kennedy, of London, obtained a tenacity of 63 tons per square inch with 42 per cent elongation on 8 inches. The application of manganese-steel has been restricted by the difficulty of machining and finishing it, due to its extreme hardness. Many articles now made of it are put to use without any tooling. The castings are exceptionally free from blow-holes. Manganese-steel car-wheels have shown surprising toughness and resistance to wear. Dredger-bolts of this material are said to outwear those of carbon steel four times. Stamp-shoes, dies, jaws, rolls and balls for crushing are also made of it, and it has been successfully employed in plowshares, rakes, shovels, etc.

*Chrome-Steel.* Chromium by itself appears to have little hardening influence upon iron; but as a third element in a carbon-alloy it produces a steel of great hardness. This property has been recently utilized in the manufacture of armor-piercing projectiles. The Carpenter steel, which has thus far given the best record in this respect, contains tungsten as well as chromium.

*Nickel-Steel.* The presence of nickel in meteoric iron, and its similarity to iron in many respects, naturally suggest it as an alloy. But it is only in recent years that the peculiar properties of nickel-steel have been recognized and utilized. The first effective public presentation of these qualities was made by Mr. James Riley (*Alloys of Iron and Steel*, Journal Iron and Steel Institute, No. 1, 1887, p. 54); and the first important application of nickel-steel was in the manufacture of armor for warships. A nickel-steel armor-plate made in America was reported by Ledebur to contain 0.28 carbon, 3.21

nickel, 0.08 silicon and 0.03 phosphorus; manganese and sulphur not determined. The French government used (1894) an armor-plate containing 0.4 carbon, 1.0 chromium and 2.00 nickel. In this alloy, the chromium furnishes hardness; and the nickel, toughness and elasticity. Hardness is communicated to nickel-steel armor-plates by the Harvey process of carburizing a part of the plate, after manufacture, and subsequently hardening it in a torrent of water. This is applied to the outside of the plate only, and produces a regularly decreasing carburization and consequent hardness from the outer surface inward, to the depth of several inches, leaving the rest of the plate soft and tough. The Harveyized nickel-steel plates have given the following results, as compared with other varieties:

	RELATIVE PENETRATION OF PROJECTILES.	RELATIVE RESISTANCE TO PROJECTILES.
Harveyized nickel-steel armor-----	1	1
All-steel armor-----	1.64	0.609
Compound armor-----	1.75	0.572
Soft-steel armor-----	2.2	0.455

Thus, for equal power of resistance there can be a saving of 43.8 per cent in weight, in favor of the Harveyized plate, as compared with the compound armor, made up of a hard-steel face and soft-steel backing, adopted by the British Admiralty in 1878. The value of nickel-steel for structural uses is indicated by the test of specimens from the nickel-steel propeller-shaft of the United States ship *Brooklyn*, showing an average tensile strength of over 93,000 lbs. per square inch, with an elastic limit of over 59,000 lbs., an elongation of 25.8 to 28 per cent, and a contraction of area of 59.81 to 61.33 per cent. The elastic limit of this shaft was about equal to the tensile strength of an ordinary mild-steel one, while elongation and contraction were nearly the same as for mild steel. (See *Nickel and Nickel-Steel*, by Francis L. Sperry, Transactions American Institute of Mining Engineers. Vol. XXV, 1895, p. 51).

*Steel Castings.* A noteworthy feature of the period under review has been the increased use of castings of steel (including ingot-iron) instead of forged iron or steel. These are made of Bessemer or open-hearth steel, the latter being the most convenient, because the same charge can be used for both ingots and castings, the part intended for the latter being left in the hearth at tapping until it has been prepared by suitable additions of spiegeleisen, ferro-silicon, etc. Basic metal can be used; but the peculiarities of the basic process (rapid combustion of silicon and carbon in the iron) are not important here, and when an open-hearth furnace is used exclusively for castings, it is generally operated with an acid (silicious) bottom. (See Ledebur's *Handbuch der Eisenhüttenkunde*, Vol. III, 2d ed., 1894, *passim*.) To make such castings solid and free from cavities due to shrinkage (piping) or to occluded gases, various means have been used, which may be classed as follows:

1. Regulation of the chemical composition of the metal, to diminish development of gases. Under this head falls the addition of manganese (in spiegeleisen, etc.), or silicon (in ferro-silicon), or aluminum. The last is the means employed in the so-called Mitis castings (made in crucibles, of very soft low-carbon metal), in which it is claimed that the minute proportion of aluminum added lowers the fusion-point of the metal, and is thus equivalent to the production of a higher temperature and a more perfect fluidity. The latest process under this head is the Walraud-Légénisel (see *Journal Iron and Steel Institute*, 1894, No. 1, p. 26), which is essentially an addition to the Bessemer operation, consisting in the addition of ferro-silicon at about the time of flame-drop in the ordinary process, and in making an after-blow, in which the silicon, rapidly burned immediately before pouring, produces a considerable increase of temperature, but no gas—since it burns to solid silica, which passes into the slag. The same temperature obtained by the combustion of carbon, for instance, would involve gas-generation.

2. The use of a casting-head, i.e., of an upward prolongation of the ingot or other mould, to receive metal, in which blow-holes, etc., may accumulate, and which may be then cut off from the casting.

3. The casting of large masses, which, cooling more slowly, give more time for the escape of gases. This is, of course, not applicable in the manufacture of direct castings for use.

4. Casting from below, with which may be classed as Whitworth's process of cooling under pressure. The latter, which requires expensive machinery, is used in a few places only.

*Crucible Steel.* Concerning this industry little can be said here, except that it has availed itself of the Siemens furnace as a means of heating, and that by the use of chemical analysis and control it has enlarged the range of its raw materials. Thus, in some places, basic, open-hearth and Bessemer scrap have been successfully substituted for more expensive irons.

*Direct Processes.* The attempts to produce malleable iron by the direct reduction of ore have taken the modified form of the production by such means of material for further treatment in the open-hearth. The Siemens process (described at length in *IRON*, Vol. XIII, pp. 347, 348) never proved a commercial success; and it is doubtful whether the conditions of permanent profit attach to any direct process, though special circumstances may render such a method locally or temporarily advantageous. (For a forcible discussion of the question, see the paper of Sir Lowthian Bell on *The Probable Future of the Manufacture of Iron* (1890), Transactions American Institute of Mining Engineers. Vol. XIX, 1891, p. 834.) The Husgafvel high bloomery, a modification of the old *Stuckofen*, in which the hearth is movable and the working continuous, has been used with reported success in Russia. The process of the Carbon Iron Company and the Adams process, both practiced for a while at Pittsburg, Pennsylvania, were suspended when the natural-gas supply became scantier and dearer. The former employs as a reducing-agent coke or graphite, which is charged upon a hearth with ore, both materials

1. Regulation of the chemical composition of

PRODUCTION OF PIG IRON AND STEEL IN THE PRINCIPAL COUNTRIES, FROM 1886 TO 1895, INCLUSIVE, IN METRIC TONS  
(@ 2,204 LBS. AVOIR.)

[From Rothwell's *Mineral Industry*, Vols. I-IV.]

YEAR.	AUSTRIA-HUNGARY.		BELGIUM.		CANADA.	FRANCE.		GERMANY.	
	Pig.	Steel.	Pig.	Steel.		Pig.	Steel.	Pig.	Steel.
1886	719,980	250,023	701,677	164,045	a25,138	1,516,574	427,589	3,528,658	1,360,620
1887	704,530	270,670	755,781	229,321	22,520	1,567,622	493,294	4,023,953	1,685,406
1888	799,227	355,038	826,850	243,647	19,781	1,683,349	517,294	4,337,121	1,862,000
1889	855,813	398,156	832,226	261,307	23,522	1,734,000	-----	4,524,558	2,022,472
1890	965,382	499,600	787,836	245,506	19,751	1,902,196	581,998	4,658,451	2,161,821
1891	921,846	a475,000	684,126	243,913	21,697	1,897,387	638,530	4,631,218	2,562,549
1892	940,284	a480,000	753,268	260,937	38,514	2,057,300	682,000	4,937,461	a2,600,000
1893	982,797	a485,000	745,264	273,958	50,754	2,003,100	664,000	4,986,030	a2,600,000
1894	1,054,520	a490,000	810,940	396,914	45,327	2,077,647	663,264	5,559,322	a2,700,000
1895	1,075,000	a495,000	829,135	455,550	38,434	2,005,889	716,931	5,788,798	a2,825,000

a Estimated from unofficial sources.

PRODUCTION OF PIG IRON AND STEEL IN THE PRINCIPAL COUNTRIES, FROM 1886 TO 1895, INCLUSIVE, IN METRIC TONS  
(@ 2,204 LBS. AVOIR.)—Continued.

[From Rothwell's *Mineral Industry*, Vols. I-IV.]

YEAR.	ITALY.		RUSSIA.		SPAIN.		SWEDEN.	
	Pig.	Steel.	Pig.	Steel.	Pig.	Steel.	Pig.	Steel.
1886	12,291	23,760	532,744	241,791	57,728	20,261	442,457	78,231
1887	12,265	73,262	613,184	225,480	288,634	-----	456,625	111,565
1888	12,538	117,785	667,737	222,288	252,116	-----	457,952	114,537
1889	13,473	157,899	749,957	258,734	197,874	49,124	420,665	137,821
1890	14,346	107,676	927,585	378,424	170,782	75,255	456,103	169,287
1891	11,930	75,925	1,004,745	433,487	278,462	69,972	499,913	172,774
1892	12,729	56,543	a919,614	371,199	247,329	56,499	485,664	158,978
1893	8,038	71,380	1,160,737	399,000	260,450	71,200	453,421	221,780
1894	10,329	54,614	1,312,760	422,500	260,000	70,000	459,132	205,865
1895	a10,500	a55,000	1,454,298	574,112	206,430	65,000	a465,000	a230,000

a Estimated from unofficial sources.

PRODUCTION OF PIG IRON AND STEEL IN THE PRINCIPAL COUNTRIES, FROM 1886 TO 1895, INCLUSIVE, IN METRIC TONS  
(@ 2,204 LBS. AVOIR.)—Concluded.

[From Rothwell's *Mineral Industry*, Vols. I-IV.]

YEAR.	GREAT BRITAIN.		UNITED STATES.		ALL OTHER COUNTRIES.		TOTAL.	
	Pig.	Steel.	Pig.	Steel.	Pig.	Steel.	Pig.	Steel.
1886	7,124,012	2,493,214	5,776,168	2,604,355	a350,000	211,756	25,862,289	7,791,645
1887	7,682,738	3,196,778	6,521,973	3,393,640	a350,000	123,847	22,977,305	9,809,263
1888	8,129,047	3,774,679	6,595,735	2,933,200	264,136	100,576	24,015,998	10,241,088
1889	8,458,486	3,605,346	7,871,599	3,441,937	380,418	242,679	26,029,980	10,574,652
1890	8,933,952	3,937,381	9,353,020	4,341,226	301,959	a250,000	27,630,712	12,448,825
1891	7,525,391	3,207,994	8,413,176	3,962,804	a350,000	a250,000	26,230,081	12,092,948
1892	6,817,274	2,996,522	9,394,428	5,001,494	a350,000	a250,000	26,863,865	12,853,263
1893	7,089,318	2,983,000	7,239,806	4,084,395	a350,000	a250,000	24,229,025	12,093,963
1894	7,364,745	a3,050,000	6,757,248	4,482,592	a350,000	a250,000	26,058,970	12,785,749
1895	8,922,006	a3,150,000	9,597,449	6,212,671	a375,000	a275,000	29,868,239	15,053,864

a Estimated from unofficial sources.

STEEL PRODUCTION IN THE UNITED STATES AND GREAT BRITAIN, IN TONS OF 2,240 POUNDS AVOIRDUPOIS.

[From Rothwell's *Mineral Industry*.]

YEAR.	UNITED STATES.					GREAT BRITAIN.				
	BESSEMER.		OPEN-HEARTH.		TOTAL.	BESSEMER.		OPEN-HEARTH.		TOTAL.
	Tons.	Per cent.	Tons.	Per cent.		Tons.	Per cent.	Tons.	Per cent.	
1886	2,269,199	91.2	218,973	8.8	2,488,163	1,579,529	99.3	694,150	30.7	2,264,679
1887	2,939,933	99.1	322,009	9.9	3,261,942	2,089,493	68.0	981,104	32.0	3,070,597
1888	2,511,101	88.9	314,318	11.1	2,825,479	2,032,794	61.1	1,292,742	38.9	3,325,536
1889	2,939,294	88.7	374,543	11.3	3,304,747	2,149,791	59.9	1,429,169	40.1	3,569,660
1890	3,088,871	87.8	513,232	12.2	4,202,103	2,914,843	59.3	1,564,200	33.7	3,579,043
1891	3,247,417	84.9	579,753	15.1	3,827,170	1,642,095	52.0	1,514,538	48.0	3,156,543
1892	4,168,435	86.2	669,889	13.8	4,838,324	1,500,810	51.4	1,418,830	48.6	2,919,640
1893	3,218,989	81.3	737,899	18.7	3,956,888	1,493,354	50.6	1,456,309	49.4	2,949,663
1894	3,571,313	82.0	784,936	18.0	4,356,249	1,535,384	49.4	1,575,318	50.6	3,110,702
1895	4,909,128	81.2	1,137,182	18.8	6,046,310	1,535,225	47.1	1,724,737	52.9	3,259,962

SHIPMENTS OF LAKE SUPERIOR IRON-ORE, BY RANGES, IN TONS OF 2,240 LBS.

[From Rothwell's *Mineral Industry*, Vol. IV, 1896.]

YEAR.	MARQUETTE.	MENOMINEE.	GOGEBIC.	VERMILION.	MESABI.	TOTALS.
1891 -----	2,511,395	1,843,326	1,848,721	891,539	-----	7,994,981
1892 -----	2,666,856	2,261,499	2,973,993	1,167,650	4,245	9,974,243
1893 -----	1,829,053	1,466,197	1,329,464	820,621	613,620	6,958,955
1894 -----	2,058,683	1,139,273	1,810,290	948,514	1,792,172	7,748,932
1895 -----	2,097,838	1,923,798	2,547,976	1,077,838	2,781,587	10,429,037
Total from opening of range-----	43,906,131	21,308,618	18,934,952	8,132,146	5,191,624	97,473,471

PRODUCTION OF CRUCIBLE AND OTHER STEELS, NOT BESSEMER OR OPEN-HEARTH, IN THE UNITED STATES, IN NET TONS (@ 2,000 LBS. AVOIR.).

[Compiled from the Annual Reports of the American Iron and Steel Association.]

YEAR.	CRUCIBLE.	OTHER STEELS.	YEAR.	CRUCIBLE.	OTHER STEELS.
1872-----	29,260	7,740	1884-----	59,662	5,111
1873-----	34,786	13,714	1885-----	64,511	1,696
1874-----	36,328	6,353	1886-----	80,609	2,651
1875-----	39,401	12,607	1887-----	84,421	6,265
1876-----	39,382	10,306	1888-----	78,713	4,124
1877-----	49,430	11,924	1889-----	84,969	5,734
1878-----	42,906	8,556	1890-----	79,716	4,248
1879-----	56,780	5,464	1891-----	81,297	5,022
1880-----	72,424	8,465	1892-----	94,874	5,094
1881-----	89,762	3,047	1893-----	71,250	3,143
1882-----	85,089	3,014	1894-----	57,996	4,571
1883-----	80,455	5,598	1895-----	75,786	961

TABLE SHOWING THE INCREASE IN PRODUCT OF PIG-IRON PER BLAST-FURNACE IN THE UNITED STATES SINCE 1874, IN METRIC TONS.

(This table is calculated as follows: The mean of furnaces reported by the American Iron and Steel Association as in blast at the beginning and the end of each year is assumed to be the number in blast during the year; and the product for the United States, divided by this number, gives the approximate average yield per furnace.)

YEAR.	FURNACES IN BLAST AT END OF YEAR.	AVERAGE ANNUAL PRODUCT.	YEAR.	FURNACES IN BLAST AT END OF YEAR.	AVERAGE ANNUAL PRODUCT.
1873----	410	-----	1885----	276	16,057
1874----	365	6,298	1886----	331	19,031
1875----	293	6,555	1887----	339	19,767
1876----	236	7,106	1888----	332	19,656
1877----	270	8,302	1889----	344	23,288
1878----	265	8,743	1890----	311	28,549
1879----	388	8,667	1891----	313	26,965
1880----	446	9,365	1892----	253	32,878
1881----	455	9,350	1893----	137	37,024
1882----	417	11,295	1894----	185	41,970
1883----	307	12,902	1895----	242	44,953
1884----	236	15,340			

being ground and mixed with a little water. A reducing-flame of natural gas is allowed to play over the charge from jets at both ends of the furnace. After an hour and a half the charge, reduced to one-third its original depth, shows beads of metallic iron over its surface, and is balled as in ordinary puddling. After all the balls are ready they are squeezed and rolled or shingled, or (preferably) are taken hot to the open-hearth bath. The sponge-balls are protected from oxidation by the adhering graphite, and as the ore employed is pure and rich

(Lake Superior, 62 per cent), the product is of excellent quality. The Adams process, as improved by Blair, and operated in Pittsburg, employs natural gas as the reducing-agent. The gas is heated, introduced into a vertical brick-lined chamber filled with ore, and, after reducing the ore to sponge, passes out through other chambers, in which it is burned to heat the walls. On the other side of these walls the incoming gas is heated without combustion. The reducing-chamber is built immediately over an open-hearth furnace, into which the sponge is dropped, without exposure to air. The quality of the product is excellent, rich and pure ore being used; and, so long as natural gas was available at a low cost, the process was successful. See IRON, Vol. XIII, pp. 278-359.

R. W. RAYMOND.

IRONCLADS. See NAVY, Vol. XVII, pp. 284-288; and NAVY, in these Supplements.

IRON CROWN, the ancient diadem of the Lombard kings. It was said to have been given to Theodelinda, wife of King Anharic, in 590, by Pope Gregory I. Charlemagne was crowned with it in 774, then it was worn by various monarchs, down to Charles V (1530), and later Napoleon I (1805). It was taken to Vienna by the Austrians in 1859, but was given to Victor Emmanuel, King of Italy, in 1866. The crown is made of a golden loop with enameled flowers and precious stones, and having inside a narrow band of iron which, it was claimed, had been made out of a nail from the true cross.

IRON MOUNTAIN, a city and the capital of Dickinson County, central north Michigan, 51 miles W. of Escanaba, at the junction of the Chicago, Milwaukee and St. Paul and the Chicago and North-Western railroads. In its vicinity there are extensive iron-mines. Great quantities of excellent ore are mined, this being the main industry of the town. The great Chapin mine, which employs nearly 1,000 men, is located here. Population 1900, 9,242.

IRON MOUNTAIN OR IRON MOUNT, a hill in St. François County, Missouri, 81 miles S.W. of St. Louis. It is about 300 feet higher than the adjacent plain, and covers 500 acres. It yields from 50 to 60 per cent of good iron, free from sulphur, magnetic, and softer than that of Pilot Knob. The amount of iron appears to be immense, as it is 50 feet in thickness and of unknown depth. Iron Mountain village contains blast-furnaces and factories, and is situated on the St. Louis, Iron Mountain and Southern railroad. Population 1890, 1,101.

IRONTON, a village and the capital of Iron County, southeastern Missouri, on the St. Louis, Iron Mountain and Southern railroad, 73 miles S. of St. Louis. Good iron and granite abound near this place. The surrounding country is fertile farmland. Population 1890, 925; 1900, 797.

IRONTON, a city and the capital of Lawrence County, southern Ohio, situated on the Ohio River, 30 miles above Portsmouth. The city is built on a small plain, or bottom, at the base of hills which abound in iron-ore and bituminous coal. At Iron-ton there are several rolling-mills, iron foundries, furnaces and manufactories of machinery, boilers, nails, stoves, fire-brick and furniture. Iron is the chief article of export. Population 1880, 8,857; 1890, 10,939; 1900, 11,868.

IRONWOOD, a city of Goebig County, western north Michigan, on the Wisconsin Central and the Chicago and Northwestern railroads, two miles from the Montreal River. It is in the rich Goebig iron region, iron-mining being the principal industry. Population 1890, 7,745; 1900, 9,705.

IROQUOIS, a confederation of tribes of North American Indians, composed originally of the Mohawks, Oneidas, Onondagas, Senecas and Cayugas, known as the Five Nations. Later, in 1712, when joined by the Florida Tuscaroras, the union was known as the Six Nations. When first visited by the Jesuits they occupied central and western New York, but soon took possession of the greater part of the basin of the Great Lakes and of the upper valley of the St. Lawrence, driving out the weaker tribes, among these being the Hurons (q.v., in these Supplements). They were never friendly to the French, but were strong allies of the English. On account of their great power, their aid was frequently sought in the colonial wars, and their assistance was secured by the British during the Revolution. During early colonial times it is estimated that they numbered 12,000, of whom 2,000 were warriors. Constant warfare reduced their power, and several severe defeats during the Revolution diminished their numbers, so that in 1784 they were glad to treat with the United States, and the greater part went across the lakes into Ontario. The confederation was broken up at that time, and afterward, in the War of 1812, some of the tribes were with the British and others with the American forces. But few remain of the once powerful Iroquois. In 1895 there were remnants of all the tribes, but the Mohawks, living in the United States, and under the jurisdiction of the government. These were distributed as follows: Cayugas, 168, having no reservation of their own, but residing chiefly in the Seneca reservation, in Cattaraugus County, New York; Oneidas, 2,107, of whom 179 lived on the Oneida reserve, Madison County, New York, 87 on the Onondaga reserve, near Syracuse, New York, and 1,841 on Green Bay, Wisconsin; Senecas, 2,981, of whom 2,693 were in New York, on the Allegheny, Cattaraugus and Tonawanda reserves, and the remainder, 288, on the Quapaw reservation, Indian Territory; Onondagas, 534, living on the Onondaga reserve, near Syracuse, New York; and Tuscaroras, 378, living on the Tuscarora

reserve, near Niagara Falls. For early history and tribal affinities, see INDIANS, Vol. XII, p. 827.

\*IRRIGATION. Farming by irrigation is one of the oldest of industries. Evidences exist that water was applied artificially to land to supplement the natural rainfall in prehistoric ages. In the United States are found the remains of vast irrigation systems, of very ancient origin. In Arizona and New Mexico the lines of great canals can yet be traced on the surface, the rivers that supplied them having long vanished, buried beneath the drifting sands of the desert, or changed in their courses, leaving the canals high and dry, often leagues away from any source of water-supply at present apparent. In the Salt River valley, in Arizona, some modern canals follow more or less closely the contour of prehistoric works of this character, and the farmers of today often are saved the labor and expense of leveling the land to fit it for irrigation, from the fact of the work having been performed centuries ago by some forgotten race.

Ancient as the pursuit may be, the essential features of irrigation appear to have changed but little from the first. Of course, modern engineering skill now enables us to impound vast bodies of water in reservoirs, and to throw immense dams across mighty rivers, and divert their waters into canals of great width and length, all of which was impossible to the ancients. But this, after all, is only a question of degree; for the men of olden times constructed their small reservoirs and diverted little streams, and then, much as we do at present, led the water by canals to the point where it was required, and finally, by ditches, distributed it to the irrigators, who utilized it on their lands.

As ages have passed, and water has become more valuable, less wasteful ways of distribution have been learned; thus the flow of a cubic foot of water per second, which, under crude methods, would water only from twenty-five to fifty acres of land, to-day, by the use of scientific means, may be made, as is done in southern California, to do duty for fifteen hundred acres. On the whole, however, the art of irrigation is, and must remain, the simple application of an elemental principle that cannot be greatly modified, except in matters of detail.

The area in the United States which is entirely or partly dependent upon the artificial application of water for successful cultivation amounts to about one million square miles, or one third of the entire country, excluding Alaska. Journeying through the central states until the 99th degree of longitude is arrived at, the region is reached where agriculture without at least partial irrigation is a very risky undertaking. This north and south danger-line swings back somewhat toward the east as it goes south, and forward toward the west as it goes north. When the 102d degree is reached, irrigation becomes an indispensable adjunct to farming. This line also swings east and west as described above. The district lying between these two degrees of longitude is described as the subhumid region; that west of them, as the arid region. The arid region stretches across the continent until the rain belt along the Pacific Coast is reached. This rain belt, which is



due to the precipitation of chilled vapor arising from the warm Japan current, which sweeps along the coast, is comparatively narrow in southern California, but broadens as it goes north, the depth of rainfall increasing in proportion to the increase of width. From the arid region may be deducted small detached areas, situated high amongst the peaks of mountains, where more frequent showers permit of a precarious agriculture without irrigation.

The western portion of the following states are included in the subhumid region, where the practice of agriculture is hazardous without the aid of irrigation: North Dakota, South Dakota, Nebraska, Kansas and Texas, and also the territory of Oklahoma. The total area actually under irrigation in this region at the present time is calculated to be, approximately, 77,500 acres. The census of 1890 showed it to have been, in that year, but 66,965 acres; the increase during six years being thus practically 15 per cent. There is opportunity for immense development of irrigation in this region. The average size of the irrigated farms in this subhumid area in the census year varied between twenty-nine acres in Texas and eighty-three acres in South Dakota, figures which have not changed materially since.

The states and territories, part or all of which are included in the arid region, where irrigation is essential, are as follows: Arizona, California, Colorado, Idaho, Montana, Nevada, New Mexico, Oregon, Utah, Washington and Wyoming. As before intimated, in most or all of these commonwealths there are some few circumscribed localities situated in the higher elevations of the mountain ranges, where, because of the increased precipitation resulting from mountain showers, farming can be carried on, with varying degrees of success, without the artificial application of water; and with the exception of southern California (where irrigation is necessary for certain crops), the rainfall is generally sufficient throughout the coast districts of California, Oregon and Washington to obviate the necessity of irrigation. In the eastern parts of these three states, separated by mountain ranges from the Pacific Ocean and the immediate influence of the Japan current, irrigation is necessary.

The monthly average rainfall for a period of 15 years at Los Angeles, southern California; and Portland, Oregon, two cities situated in the coast rain-belt, is shown by the following diagram, and is indicative of the conditions prevailing in the districts surrounding them. It will be observed that the precipitation in both instances is greatest in the winter and spring months and least in the summer and autumn. In the Oregon district the rainfall is ample during the greater part of the year, and usually adequate, though scanty, in the driest months, to sustain plant-life. At Los Angeles, also, during the winter and early spring months, the rainfall is, on an average, sufficient, but inadequate during the late spring, summer and autumn. Hence, in southern California, crops, such as the cereals, that attain their growth during the winter and early spring, and are harvested in the early summer, do not necessarily require irrigation, but most of those

of other habit must, except in particularly favored localities, where the soil is unusually retentive of moisture, be more or less artificially watered to produce profitable results.

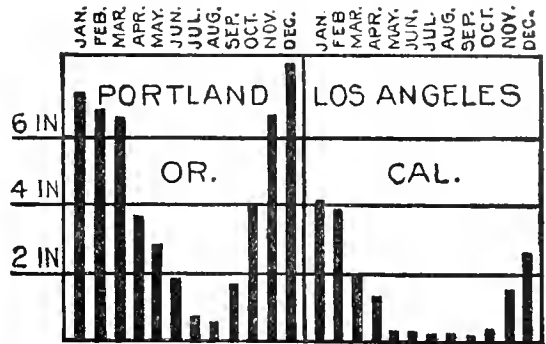

The area under irrigation in these eleven states is, approximately, 4,250,000 acres, or nearly 20 per cent greater than in 1890, when the census showed it to be 3,564,416 acres, which area, however, was considered by many authorities to be somewhat an underestimate. The total irrigated area in the United States is thus shown to be 4,327,500 acres. The average size of the farms in the arid region was 68 acres, the largest being in Nevada, where the average area was 192 acres, and the smallest in Utah, where the average was 27 acres. These figures may be accepted as being unchanged and practically correct in 1896.

The average value per acre of irrigated lands in the arid region is calculated, by the United States Department of Agriculture, to be \$83.28, ranging from \$31.40 per acre in Wyoming to \$150 per acre in California. This wide divergence in value is chiefly due to the different character of the products suitable to and grown in the several districts. In Wyoming, for instance, ordinary farm crops are raised, of which there is a surplus in the country as a whole, and of which, therefore, the price is low; while in California a large proportion of the produce consists of subtropical fruits, such as oranges, lemons, olives, etc., of which a sufficiency is not raised in the country, as a whole, to supply the demand, and of which, therefore, the price is high. As a natural consequence, California irrigated land is of much greater value than similar land in Wyoming. This general law, however, is modified sometimes by local conditions. There are many districts in which only the ordinary farm crops can be grown, where the local irrigated areas are insufficient to supply the local demand for such products. In such places the price of grain, etc., is equal to the price of like articles at the nearest point where there is a surplus to draw from, plus the cost of carriage from there. In those districts, therefore, where the farmer is afforded a protective tariff by the imposition of freight rates, the value of land is naturally higher than where the irrigated area is more than ample to supply the local demand, and where, therefore, no outside produce is imported to supply the deficit.

The average annual value per acre of the crops

raised on irrigated lands in the eleven arid states is calculated by the United States Department of Agriculture to be \$14.80, ranging from \$8.25 in Wyoming to \$19 in California. Such figures, however, are apt to be misleading, unless due consideration be given to the circumstances under which the averages are arrived at, the general average being, in all instances, far below the results attained by intelligent farmers in carefully selected locations. The average for California, in particular, is affected by another condition, which exists, also, in some degree, in all other places; namely, that the average for the large area devoted to raising ordinary low-priced crops lowers the average of the comparatively small area bearing citrus fruits and other high-priced products, the value of which per acre is immensely greater than the general average. These and other modifying conditions must be accorded due weight when the average value of crops is being considered.

It is claimed very generally by irrigating farmers in the United States, and indeed the world over, that the benefits accruing from irrigation more than compensate for the expense and labor incurred by its practice. Before investigating the accuracy of this claim an estimate of the cost of irrigation in this country is necessary.

The average cost of bringing water to the land on which it is used, throughout the subhumid and arid regions, is \$8.15 per acre, varying from \$3.62 in Wyoming to \$12.95 in California. This preliminary expense, however, in the large majority of cases, is not made directly by the farmer, the water more often being conveyed to the land by canals owned by companies incorporated for the purpose. It is usual for the farmer in such cases to contract for the perpetual annual supply of a specified amount of water. The water thus contracted for, or otherwise procured, is termed a "water right." The present average value of water right in the region the above figures apply to is \$26 per acre, varying from \$8.69 in Wyoming to \$39.28 in California. A water right is thus seen to be valued at present at more than three times its original cost. The value of water right, plus the value of land prepared for irrigation, forms the value of irrigable land, as already quoted. It must not, however, be forgotten, in this connection, that, in the arid region, the fact that any certain piece of land is situated so as to be capable of being irrigated adds immensely to its worth, even if at present it is not supplied with water. Of land that it is impossible to irrigate there is a vast abundance, and its value is almost nominal. The outlay for water right, whether incurred by purchasing from a company, or by the farmer himself constructing the necessary works, should be considered a capital expenditure and added to the first cost of the land when comparing the relative merits of farming with and without irrigation. The cost of water right must not be confused with annual water rental, which is the yearly sum paid for the regular delivery of the water to the land, an outlay necessitated by the cost of keeping the canals and other works in repair. Another preliminary expense to be borne by the irrigating farmer,

and to be charged to capital account, is the preparatory leveling and preparing of the land. The cost of this varies so widely that the quotation of an average figure would be misleading and worse than useless. Sometimes, on level prairie or valley land, the expense is merely nominal; but, where much clearing of brush, grubbing of roots and leveling of inequalities has to be done, the cost may run up to \$10 or \$20 an acre. This wide difference in the cost of preparing land is equalized largely, however, by the fact that the price of rough land is proportionately much lower than smooth land, other conditions being equal. Water rental, or in other words, the annual cost of the delivery of the water called for by the possession of water right, averages \$1.07 per acre throughout the arid and subhumid regions, varying from 44 cents in Wyoming to \$1.60 in California. It will be noted that the cost of water right and the annual rental increase and decrease in proportion. The reason for this fact is not far to seek. In Wyoming, for instance, where low-priced crops alone are produced, only such irrigation-works are constructed as can supply water cheaply; whilst in California, where the fruit crops are of high value, irrigation-works, which are very costly to construct and maintain, can be utilized profitably.

A quotation of the average cost of actually applying the water to the land would be misleading and useless, as it varies so widely, according to circumstances.

It is calculated that in Colorado, under very favorable conditions, one man can irrigate 25 acres of growing grain per day. Twelve acres per day, however, may be taken as a fair average for that class of crop. Presuming the irrigator's wages to be \$1.50 per day (including his board), and that four irrigations are necessary during the season (including one before seeding), the cost of actually applying the water would be 50 cents an acre each season. It must be borne in mind that this figure applies merely to grain-fields on the comparatively level prairies of Colorado. The calculation bears no relation to the cost of irrigating other crops elsewhere.

It will thus be seen that the irrigating farmer is called upon to pay, first, for the land in its natural condition; secondly, for a water right; thirdly, for fitting the land for irrigation; fourthly, the annual water rental; and lastly, the cost of applying the water to the land; whilst the farmer who depends upon natural rainfall to supply moisture is free from all these expenditures, excepting the first and sometimes a part of the third, where the removal of brush or timber is called for. At first glance it would thus appear as if the conditions were strongly in favor of the agriculturist, who relied upon rainfall, but a little deeper investigation leads to an opposite conclusion. In the first place, the average cost of land in the arid region with water right, and prepared for irrigation, is, if anything, lower than the cost of land in the humid region, if the value of the produce raised on the land be taken as the basis of estimation. This is an important consideration, often overlooked. Another material fact is, that,

when irrigation is practiced intelligently, the raising of a crop every season is as nearly certain as anything human can be. Exactly the amount of water necessary to the perfect development of any given crop can be applied exactly at the time it will do the most good. The disastrous vagaries of nature, as exhibited by abnormal rainfall or prolonged drouth, are overcome by the ingenuity of man. In the arid region it never (or so seldom that it is hardly worth while considering the possibility) rains too much, so that the farmer is relieved of the apprehension that his crops may be drowned out. Neither does the dread of drouth and parched fields weigh upon his mind; for he knows that by the mere opening of a sluice an adequate supply of water will be carried over his land. Nor will cold or cloudy weather retard the maturing of his harvest; for almost constant sunshine is present throughout the day to force plant-life to early and vigorous maturity. In short, he is largely freed from the anxieties that are the lot of the farmer who depends upon natural moisture. Another condition in his favor is, that, the quality of the soil, etc., being equal, he is assured every season of a crop as heavy as an exceptionally abundant one in the humid region; for every year his artificially produced climatic conditions equal those of the most favorable season in the country of rainfall. No better condition can prevail in the best of years anywhere than almost constant sunshine and exactly adequate moisture, and this happy state of affairs exists every season, with uninterrupted regularity, in the arid portion of the United States, where irrigation is conducted properly.

Another condition in favor of the irrigator is the fact that, with certain exceptions hereinafter to be mentioned, the water applied in irrigating enriches the land as well as moistens it, and partly, fully, or more than fully, compensates for the impoverishment caused by the growing of crops. As a stream flows along, there are washed into it, and it collects from its crumbling banks, fertilizing elements, the most valuable of which it carries with it, precipitating the valueless coarse sand and gravel in its bed. The rich elements eventually are carried upon and remain in the land irrigated by such water. The Nile has long been famous for the fertilizing qualities of its water, the lands irrigated by it having been cropped for unnumbered centuries, and showing no decrease in richness, although fertilizer, other than that supplied by the water, seldom or never is applied by the natives. In this country the Rio Grande del Norte, running south through Colorado and New Mexico, is exceptionally rich, especially in its lower reaches, where its muddy flow deposits at each irrigation about a sixteenth of an inch of smooth, greasy mud, which analysis shows to be of the highest nutritive value to plant-life, presented in a form particularly easy of absorption. Irrigators in southern New Mexico, and lower down the river, are fully aware of this characteristic, and often take advantage of it to make rich land out of barren sand. A few soakings with Rio Grande water on the most hopeless-looking sand will enrich it sufficiently to yield a fair crop, and each season, as irrigation is continued, the soil becomes more

mellow and fertile, until finally it is as good as the best in the neighborhood.

Mr. R. J. Hinton, in his able report to the government, in 1891, on irrigation in the United States, says, in regard to this matter: "The value of irrigation as a fertilizer of the soil may be seen in the fact that the Pima Indians of Arizona have cultivated the same land—a portion of which they now occupy—for at least five hundred years. Their cultivation, though rude, has been extensive and well conducted. Nothing has ever been applied to the land but the water, which quickens and fructifies it. As large crops are now raised as any of which the traditions of these Indians bear record." Scientific European, Asiatic and African investigations bear testimony to like facts.

As is natural to suppose, some streams are more potent in their power to enrich than others, the amount and quality of fertilizing matter they carry being regulated by the nature of the soil prevailing in the country through which they flow. Also, a stream is usually unequal in richness in its different parts, it generally diminishing in fertilizing quality as it nears its source, where its water necessarily has gathered less alluvial wash. It is not, therefore, intended to be asserted that the practice of irrigation always and altogether obviates the necessity of artificial fertilization of land; but it is an undoubted fact that such is sometimes the case, and that, generally, it more or less enriches the soil, and lessens the quantity of manure necessary to produce the best results. This beneficial characteristic does not, however, apply to water derived from artesian or other wells, which, from its nature, cannot carry fertilizing elements of the nature described.

The chief factors that count in favor of the irrigating farmer in the arid or semi-humid portions of the United States having thus been stated, it is now necessary to discuss such drawbacks as may exist.

The first objection that may be urged is, that the art of successful irrigation is one that can only be acquired by close study and experience.

In other words, an irrigator must not only possess all the knowledge that a farmer in the humid region possesses, but, besides, he must understand the art of artificially applying water to land and growing crops—a knowledge not as easily acquired as might be supposed, as many an inexperienced irrigator has found, to his cost, a crop is ruined easily by an ill-timed or disproportionate application of water. Different soils call for different amounts of water, and different methods of applying it, according to their character and the nature of their subsoils. The amount of moisture best suited to the several crops also varies very greatly, as do, also, the seasons when it should be applied to them. These are details that can only be learned by experience, and often are gained at considerable cost. Another danger exists in the quality of the water that is to be used,—a matter which should be made the subject of exhaustive test, for there may be carried in solution an amount of alkali that will in time render the land it is applied to utterly worthless. Many farms in the West that formerly were prolific are to-day barren from this cause.

The water applied in irrigation filters itself in soaking through the earth, and leaves behind, in the soil it moistens, the greater part of all matter it holds in suspension or solution; hence, when it is charged with alkali, each irrigation adds to the normal quantity of alkali in the soil, until at length it becomes so supercharged with this substance that it is poisonous to plant-life. Land with an impervious subsoil is ruined much more rapidly in this way than when the subsoil is gravelly and open; for when the latter condition prevails, the filtration is more complete, and therefore less alkali is retained in the surface soil. The converse of this land-poisoning by alkali-water is also true; for when land is naturally supercharged with alkali, and water that is free from alkali can be obtained wherewith to irrigate it, the alkali is washed out gradually, and in time the soil becomes fertile. It may be taken as an axiom by irrigators that alkali land is bad, but alkali water is fatal. One of the greatest irrigation systems in the United States, that of the Pecos River in New Mexico, did not at first meet the high expectations of its promoters, from the fact of alkali being present in unexpectedly large quantities in the water. Eventually, expensive modifications were made in the plant, by which the water from a certain highly alkaline creek was cut off and the cause of failure was removed, and success resulted.

The methods of applying water to land are many. There are, however, but two found in general practical operations; viz., flooding, and distribution through furrows. A third method, that of sub-irrigation by pipes, is used occasionally, where water is very scarce, and where the value of the crop is such as to admit of the great expense necessitated. It is practiced in some few citrus orchards in southern California. The plan, in short, is to run underground an iron pipe along each row of trees, there being opposite each tree an orifice through which the water escapes. By this plan, when the pipes are charged with water, the soil surrounding each tree is moistened and a minimum of water is used. This plan, economical in theory, is not found generally practical in operation, the outlets, and sometimes the pipes themselves, becoming choked. A modification of this plan, where porous earthenware pipes are used, has been tried, with, however, only partial success. The most ordinary method of irrigation, especially for cereals, alfalfa, etc., is by flooding. This is the easiest way, but the most wasteful of water. Its operation is as follows: After the land has been leveled, it is divided into compartments by ridges of earth, called "checks," six inches or so high. Each compartment thus formed is connected with a small ditch, known as a "lateral," which runs from the main ditch. The size of these compartments is regulated by the slope of the land and the volume of water obtainable. The object aimed at is to fill each compartment to a certain depth, as nearly as possible equal, over its entire surface. Supposing the fall of the land to be one inch in each 100 feet, and it is the intention to supply an average depth of four inches of water, it is obvious, that, in a compartment measuring 200 feet in the direction of

the slope, at the upper end there would be a depth of three inches and at the lower end five inches of water, where it would be within an inch of the top of the dividing ridge. If the compartment measured only 50 feet in the direction of the slope, the difference in depth of water at the upper and lower end would be only half an inch. As, however, the smaller the compartment, the slower and more expensive the irrigation becomes, it is well to let the compartments be as large as the lay of the land will allow. When one compartment is filled, the water flowing into it is shut off from it and allowed to flow into the one adjoining, and so on from compartment to compartment. The ridges or checks should be broad at the base, the sides sloping up gradually, so that when the crop is being harvested they will not interfere with the easy working of the reaping-machine, as they would do if the sides rose abruptly. The annexed illustration shows clearly the operation of this method.

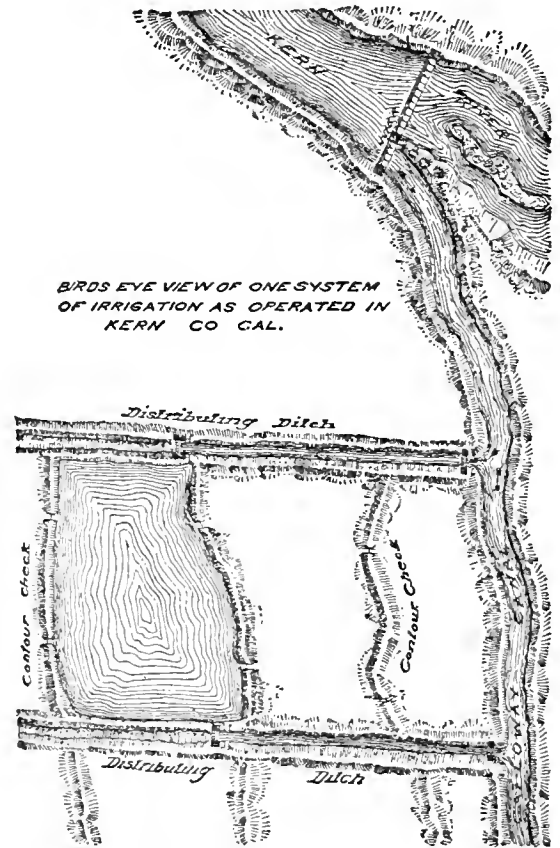

BIRD'S EYE VIEW OF ONE SYSTEM OF IRRIGATION AS OPERATED IN KERN CO CAL.

It will be noticed that the ridges do not run in a straight line. The bends are caused by the necessity of exactly following the contour of the land. If this were not done, and the ridge were to be run in a straight line, it would undulate, and the water would flow over the low places before the compartment was full. Irrigation by the furrow system produces better results than flooding, in orchards and vineyards, and is practically the only system that can be followed with such crops, for instance, as potatoes, as are grown in rows. Also less water is used by this system than by flooding, which is

often an important consideration. It has been found that flooding the entire surface around fruit-trees and vines tends to bring the roots to the surface, necessitating more frequent watering, besides incurring the risk of injury to the roots from scorching in very hot weather. The method most successfully followed is to plow a fresh furrow for each irrigation, the furrow running in such a direction as to have a fall of about two inches per 100 feet. The water then is turned into the furrow, down which it slowly flows, soaking the adjoining soil beneath the surface as it goes. After the water is turned off and the earth has become dry enough to permit, the soil is plowed back into the furrow, thereby permitting only minimum of loss by evaporation. With young trees or vines, two furrows, about four feet apart, one at each side of the row of trees, will supply sufficient moisture; but, as the trees grow and the roots spread, other furrows have to be added, about six feet distant from each other. It is the opinion amongst experienced horticulturists that it is injurious to trees or vines to allow the water to touch the trunks. Sometimes holes are made in the ditches opposite the trees, by driving a stake down a few feet and pulling it up. By this means the water more easily reaches the deeper roots.

As has before been stated, the necessary number of irrigations a year, and the amount of water required, vary so much that it is impossible to lay down any definite rule. Such is the divergence of practice, that farmers on adjoining farms, where the quality of soil is similar and the same crops are being raised, may differ 50 per cent in the number of times they irrigate and in the amount of water they use. Generally, however, it is conceded by the most experienced irrigators that the best results are attained where a minimum application of water in frequency and amount is adhered to, consonant with a vigorous and healthy condition of plant-life. In southern California, oranges are watered usually from three to five times during the summer, and not at all in the winter, when the rainfall is generally sufficient. In southern New Mexico, vineyards are irrigated where sufficient water is obtainable, every two or three weeks during the spring and summer; and in Colorado, on wheat, alfalfa, etc., three or four waterings are the rule. The character of the soil and subsoil, the slope of the land, the amount of rainfall, the temperature and dryness of the air, the method of irrigation, the character of the crop, and the ability of the irrigator, are some of the factors which go to regulate the amount of water required.

Irrigators usually express the measurement of water in cubic feet per second, and speak of the amount of land a given measurement of water will irrigate as the "duty of water." Thus, if a canal has a flow of 100 cubic feet of water per second, and irrigates 5,000 acres, the duty of that water is said to be 50 acres per cubic foot per second. The census report on irrigation of 1890 gives the duty of water in California, where great economy is practiced, as 200 acres per cubic foot per second, rising sometimes, in rare cases, as high as 500 acres; whilst in Colo-

rado it was calculated to be from 90 to 200 acres. The lower figure is probably about the average duty of water throughout the arid region, where farm crops are grown, and 150 acres where orchards and vineyards are in question. As high a duty as 1,500 acres has been obtained in southern California by the use of subirrigation by pipes, as already described.

The duty of water in America is lower than it is, on an average, in either India or Europe, where the regulations regarding its use are enforced much more rigidly. The duty will increase in this country as water become scarce and more valuable, and economical methods of using it force themselves upon irrigators. An increased duty of water will also occur when it becomes more generally understood that thorough and constant cultivation of the surface, besides being beneficial in other ways, forms a covering that tends to prevent evaporation from the lower soil, thereby retaining the moisture and necessitating less frequent irrigation. The lessening of evaporation and seepage whilst the water is flowing in the canals and distributing-ditches will be another source of economy. It is calculated by a reliable Colorado authority that the average loss of water to irrigators in that state, from these two causes, amounts to 12 per cent, whilst in India the loss is computed by government engineers to amount, in some cases, to as high as 69 per cent. The porosity of the soil through which canals and ditches pass, and the dryness and heat of the atmosphere, vary so greatly in different localities that the calculation of an average loss from these causes would be valueless. In the Tulare irrigation district of California a loss of 36 per cent was allowed for by P. J. Flynn, the engineer who planned the works there. This, however, is no indication of the allowance that should be made in other districts, where the soil and climatic conditions are dissimilar. The loss by seepage is obviated entirely, in some irrigation systems, by the sides and bottom of the canals and distributing-ditches being rendered impervious by a lining of concrete. Piping, also, in some instances, has been resorted to to prevent seepage and evaporation, but the great cost of such a method prevents its use except in instances where water is extremely valuable. Pipes for this purpose, where they are subject to pressure, usually are made of wrought iron, or of wood bound with iron bands, and of continuous concrete where the water flows by gravitation without pressure.

In planning an irrigation-canal or distributing-ditch, one of the first and most important points to be considered is the slope that should be given to the bed. It is obvious that, the steeper the grade, the more rapid will be the flow of water; in other words, the greater the fall is, the smaller need a channel be to deliver a given amount of water in a given time. It is economy, therefore, to allow as much slope as conditions will permit of to a canal or dit h. If the grade be too steep, and the flow of water too rapid, destructive abrasion of the sides will take place, and, also, the channel will deepen itself, until in time it will cut below the level of the land to be irrigated, and thereby be rendered use-

less. If, on the contrary, the channel be given too little slope, and the water flow too slowly, besides incurring the expense of constructing an unnecessarily large channel, silt will be deposited, which, from time to time, will have to be removed, necessitating turning the water out of the canal whilst the work is being performed, and the expenditure of time and money.

Dubuat, the famous French hydraulic engineer, gives the following maximum velocities as suitable to channels passing through various soils.

SOILS.	FEET PER SECOND.
Soft brown earth.....	0.328
Soft loam.....	0.656
Sandy soil.....	1.312
Gravelly soil.....	2.625
Pebbles.....	3.938
Broken stone, flint.....	5.579
Conglomerate, soft slate.....	6.564
Stratified rock.....	8.204
Hard rock.....	13.127

Practical experience in this country teaches that these velocities may be exceeded 15 or 20 per cent without material injury to the works.

The following table, computed by Kutter's formula, which is accepted by engineers generally as the most reliable, shows the grade to be allowed a canal passing through gravelly soil so that the maximum safe flow of water (2.625 feet per second) according to Dubuat's calculation may be attained:

WIDTH OF BED IN FEET.	DEPTH IN FEET.	GRADE PER MILE.	DISCHARGE IN CUBIC FEET PER SECOND.
6	2.5	5 feet	52.0
10	3.0	4 feet	103.0
20	4.0	2 feet	233.3
40	4.5	19 inches	504.6

These grades should be lessened or increased according to the nature of the soil through which the channel passes, this formula applying to gravelly soil, as above stated. It will be noted, by reference to this table, that the speed at which water flows down a given grade increases as the body of water increases; hence, the larger the ditch, the less should be the grade to attain a desired velocity. It sometimes occurs that the character of soil through which a channel passes will not permit of a flow rapid enough to obviate the deposit of silt. When such a condition prevails, it may prove an economy to provide an apparatus to remove as much as possible of it at a point close to where the water enters the canal. The adoption of such a contrivance, and the saving resulting therefrom, has transformed many irrigation companies from unprofitable to paying concerns. One of the most simple and effectual plans is as follows: For a thousand feet or so from the head, the width of the canal is increased, and its grade lessened, in such proportion that, though somewhat more water is carried than will be required to fill the canal at its normal width and grade, the flow will be only an inch or two per second. Before the point is reached where the canal narrows to its normal width, a double bottom is built, so that the lowest six or eight inches of water will flow beneath a plank flooring, carrying with it a large percentage

of the silt which has been permitted by the slow current to gravitate toward the bottom, whilst the upper water, largely divested of deposit, flows over the flooring onward into the canal. The lower water from under the flooring is allowed to escape back into the stream from which it was diverted, through a sluice in the side of the canal.

It is usually necessary to construct a dam or weir across a stream at the point where water is diverted from it into a canal. Such works vary in construction from a temporary obstruction formed of brush and rocks to the most costly and scientific engineering-works. Where more than the former is necessary, the advice of a competent engineer is essential, each case requiring its own particular treatment, no general rule being capable of application.

It has sometimes been found profitable to build submerged dams to bring subterranean water to the surface, so that it can be utilized for irrigation. In many instances the underflow of Western streams exceeds the surface flow, and it sometimes occurs in considerable volume where there is no surface flow at all, or only in seasons of flood. The method of ascertaining if there be underflow is usually as follows. After diverting the surface flow, if there be any, shafts are sunk across the channel to bed-rock. If, in the water in these shafts, a current is observed, it is a sure indication of considerable underflow; or if, when it is colored by a dye, the colored water is replaced soon by clear water, it shows that some water is passing through the shaft. If, after these experiments, it is decided that there is sufficient water to justify the expense of bringing it to the surface, a trench is dug across the channel to bed-rock, and an impervious dam of masonry, concrete or puddle is erected to cut off the subterranean flow, and bring it above-ground. Many works of this character are in successful operation in California and elsewhere in the West. Large areas, also, are irrigated with water obtained from artesian wells in several districts in the arid region; but water from such sources carries with it little or no fertilizing elements, and thus is less valuable than good river water for the purposes of irrigation, as is also the case with that drawn from lakes or large reservoirs, in which the greater part of the valuable matter held in suspension has been deposited.

The laws governing irrigation and the proprietorship of water vary somewhat in the different states and territories, the general object being, however, in all cases, to preserve to the prior appropriator of water his continuous right thereto. It is obvious that agriculture by irrigation would be too risky an occupation to be entered upon if it were permissible that a newcomer should locate above nearer the source of a stream or canal than an older settler, and cut off the water-supply of the latter. Statutes covering this important point exist in all the arid and subhumid states and territories, safeguarding the rights of the prior appropriator. In California an important law was enacted in 1887, known as the Wright Law. This act provides for the creation of irrigation districts, if the wish of the majority of the inhabitants is indicated so, by the ballot-box. Bonds can then be

issued, secured by all the lands in the district, the proceeds of their sale being used for the construction of irrigation-works. This law has proved by no means an unqualified success, perhaps the chief cause of failure being that the local farmers and business men, who are called upon to control the expenditure of vast sums of money and manage vast irrigation systems, are usually not fitted by any previous experience in that direction to undertake the task. Under such conditions the failure to attain the best results is not to be wondered at. The constitutionality of the law was questioned, thus putting in jeopardy vast sums of money already invested in irrigation district bonds, but in November, 1896, the Supreme Court upheld its validity.

The tendency, in districts where farming is carried on by irrigation, is toward the subdivision of land into small holdings. As has before been stated, 68 acres is the average size of irrigated farms in the 11 arid states and territories. If the averages of Nevada and Wyoming (where large areas of meadowland are flooded with little care and attention) were omitted, the figures would be reduced to 59 acres. Small farms more highly cultivated than those in the Eastern humid states are the rule, large bodies of irrigable land in the hands of individuals or corporations being the exception in the arid region. This segregation of land into small holdings is a condition that is being promoted by both state and national legislation, as far as possible. The provisions of what is known as the Carey Law, by which one million acres of land in each arid state has been transferred from United States to local control for the purpose of its reclamation by irrigation, are purposely drawn with the object of insuring a continuance of these conditions. Comparatively dense population, with all the social and educational advantages attached to it, results from this division of land into small farms.

One finds to-day, in all the arid states and territories, cultivated and prosperous communities, where, if it were not for irrigation, a ranch-house or two, and a few cowboys tending cattle, would be the only indications of human occupancy. In short, irrigation has been the chief means of conferring upon the far West a settled and stable civilization. By it the desert has literally been made to bloom, and vineyards and orchards, meadows and fields of smiling grain, churches and school-houses, the possessions of cultivated, law-abiding communities, have replaced the barrenness of a region that, a few years ago, was chiefly the resort of herds of bison and roving bands of Indians. And it must not be forgotten that the work is yet only in its infancy. There are still millions of cubic feet of water flowing away unutilized, that can be brought under control, and millions of acres of arid land awaiting only the quickening touch of moisture to yield up its richness. The people of the United States are not slow in developing the resources of their country, and there is little danger in prophesying that before this generation has passed the present area under irrigation will be tenfold enlarged, and support a correspondingly increased population. What has already occurred points to such a consumma-

tion, and even higher expectations may be fulfilled. When it is remembered that the population of the eleven counties in California most deeply interested in irrigation, increased 753 percent during the decade that intervened between 1880 and 1890, it is not easy to place a limit to the possibilities held by the future. See also AGRICULTURE, in these Supplements.

H. F. GRIERSON.

IRRITABILITY, in plants, depends upon the irritability of their protoplasm, and relates plants to their external conditions. Sudden changes in external conditions, or in the direction or intensity of the forces acting upon the plant, act as stimuli, the most evident response to which are movements. The common stimuli which result in movement are contact or pressure, variations of temperature, variations in intensity of light, changes in direction of the rays of light, changes of position in relation to gravity.

IRRITANTS. See POISONS, Vol. XIX, p. 277.

IRISH. See SIBERIA, Vol. XXII, p. 5.

IRVINE, WILLIAM, an American Revolutionary soldier; born near Enniskillen, Ireland, Nov. 3, 1741. He graduated from Dublin University, and served in the navy as surgeon during the war between Great Britain and France (1756-63). In 1764 he moved to America and settled in Pennsylvania; served in the Colonial army during the Revolution, rising to the rank of brigadier-general in 1779; was on the board of court-martial which tried General Charles Lee in 1778; in 1781 had command on the western frontier; was a member of the Continental Congress in 1786; and was one of a commission appointed to settle the accounts of the United States with the several states. He was a member of the Third Congress; afterward moved to Philadelphia, where he was in command of military stores, and was president of the State Society of the Cincinnati at the time of his death, July 29, 1804.

IRVING, DAVID, a Scotch biographer; born in Langholm, Dumfriesshire, Scotland, Dec. 5, 1778. He was educated at the University of Edinburgh, and published, while there, a *Life of Robert Ferguson*. From 1820 to 1849 he was librarian to the Faculty of Advocates in Edinburgh. He was the contributor of the biographies of Scottish authors to the seventh edition of the *Encyclopædia Britannica*, and wrote *Elements of English Composition* (1801); *The Lives of Scottish Poets* (1804); *Memoirs of the Life and Writings of George Buchanan* (1807); *Observations on the Study of Civil Law* (1815); and a *History of Scottish Poetry from the Middle Ages Down to the Close of the Seventeenth Century* (1861). He died in Edinburgh, March 10, 1860.

IRVING, SIR HENRY, the adopted name of John Henry Brodribb, the British actor, who has long been associated with Miss Ellen Terry in the histrionic art, was born at Keinton, near Glastonbury, England, Feb. 6, 1838. In his eighteenth year, after a brief education in London, he made his first public appearance at the Sunderland

Theatre. It was not until 1870, however, that he made any distinct mark as an actor. His



SIR HENRY IRVING.

first indubitable success was as Mathias in *The Bells*, from which early triumph Mr. Irving may be said to date his great career. Other fine impersonations succeeded, including those which have since become favorites on the boards, Richelieu, Louis XI, Charles I, Eugene Aram and Hamlet. His *Hamlet*, which was produced in 1874, had a run of two hundred nights, and though his impersonation of the melancholy Dane was at first hotly challenged by the critics, they afterward accepted his rendering of the character, and in this as well as in other Shakespearean parts, admitted him to the first rank among English tragedians.

To his Shakespearean repertoire, Mr. Irving added *Macbeth* in 1885, *Othello* in 1886, and *Richard III* in 1887, the production of which largely extended his fame. In conjunction with Miss Ellen Terry, he put upon the stage, with fine artistic effect, Tennyson's drama of *Queen Mary*, in which Mr. Irving assumed the part of Philip of Spain. Later on, he produced *The Cup* and *The Foresters*, by the late poet laureate, both of which were set on the stage with magnificent scenic effect, but did not prove drawing pieces. Among his successes, in the next few years, was his appearing in *The Lyons Mail*, in *The Corsican Brothers*, in *Faust* and in *The Deal Heart*. His great reputation, however, was secured by a return to Shakespeare, of whose dramas he had become an intelligent and acute student, and whose dramas he placed on the boards with the most tasteful and ingenious settings.

Mr. Irving first visited America in 1883. A second visit was made in the following year, when, in addition to his performances at Daly's Theater in New York, and other theaters in the chief cities of the United States, he delivered an *Address on Acting* to the students of Harvard University, published in his four addresses on *The Drama* (New York, 1893). This volume also included the lecture delivered at Oxford on the invitation of the late Chancellor Jowett. In 1894 he received the honor of knighthood from the Queen. In no character, perhaps, has Mr. Irving won greater or more deserved applause than in *Macbeth*, for his delineation of the part was marked by the highest qualities of the actor's art, rendered still more successful by the magnificent scenery, costumes, and mounting of the play. His later productions include Shakespeare's *Henry VIII*, in which he played the part of Wolsey (1892); Tennyson's *Becket* (1892); *King Arthur* (1895); *Peter the Great*, a powerful but gloomy drama, by his son Laurence Irving (1898); and Sar-

dou's *Robespierre* (1899), written specially for the actor. He wrote several papers on his art in the *Nineteenth Century*, and an introduction to W. H. Pollock's translation of Diderot's *Paradox of Acting*.

IRVING, JOHN BEAUFAIN, an American painter; born in Charleston, South Carolina, Nov. 26, 1825. At the age of 22 he went to New York to study art, but did very little until 1851, when he went to Düsseldorf to study under Leutze. On his return to South Carolina he painted portraits until the war, after which he opened a studio in New York. His work as a *genre* painter is superior to his portraits, though the latter were often very successful. The coloring, finish, and composition of his pictures were especially fine. Among his paintings are *Cardinal Wolsey and his Friends*; *The End of the Game*; *The Last Rally*; *The Connoisseurs*. He was elected associate member in 1869, and full member in 1872, of the Academy of Design. He died in New York City, April 20, 1877.

IRVING, WILLIAM, an American merchant, brother of Washington Irving; born in New York City, Aug. 15, 1766. He was a fur-trader on the Mohawk River until 1793, when he settled near New York and married a sister of James Paulding, one of the authors of *Salmagundi*. He was elected for three terms in Congress (1814-18), when he resigned on account of failing health. His contributions to *Salmagundi*, if collected, would give him a distinct place among American humorists. He died in New York, Nov. 9, 1871.

IRVINGITES. See CATHOLIC APOSTOLIC CHURCH, Vol. V, p. 237.

IRVINGTON, a village of Marion County, central Indiana, on the Pittsburg, Cincinnati, Chicago and St. Louis railroad, five miles E. of Indianapolis. It is a suburb of that city, and has several elegant residences; also an organ factory employing 200 men. It is the seat of Butler University (Christian), founded in 1850, which has 22 instructors and 215 students, and a library of 6,123 volumes. Population 1900, 1,799.

IRVINGTON, a village of Westchester County, southern New York, on the Hudson River railroad, 24 miles from New York. Sunny Side, the former residence of Washington Irving, is in the immediate vicinity. It is beautifully located, and is the home of many New York business men. Population 1890, 2,299; 1900, 2,231.

IRWIN, a borough of Westmoreland County, southwestern Pennsylvania, at the junction of the Pennsylvania and Youghiogheny railroads, 22 miles S.E. of Pittsburg. Several coal-mines are here and mining-supplies and glass are manufactured. Population 1900, 2,452.

IRWIN, JARED, an American statesman; born in Mecklenburg County, North Carolina, in 1750; removed to Georgia with his parents while yet a boy. He served in the American army the last four years of the Revolution; was a member of the first state legislature, and a member in 1787, when the constitution of the United States was adopted; was a member of the state constitu-



tional conventions of 1789 and 1795, and president of the convention that formed the constitution in 1798; was elected governor of the state in 1796 and again in 1806. It was during his first term that the famous law, which permitted the "Yazoo frauds," was rescinded. He died at Union Hill, Georgia, March 1, 1818.

IS. See HIT, Vol. XII, p. 24.

ISABELLA II, MARIA ISABELLA LOUISA, ex-Queen of Spain; born in Madrid, Oct. 10, 1830.

Her father, Ferdinand VII, had been induced by the influence of his wife to issue the pragmatic decree, revoking the Salic law; and at his death, Sept. 29, 1833, his eldest daughter, then a child, was proclaimed queen, under the regency of her mother, Maria Christina. This event proved the signal for civil warfare, as the claims of the late king's



ISABELLA II.

brother, Don Carlos, were warmly supported by certain classes of the people. The war of succession lasted seven years, until the Cortes confirmed the claims of Isabella by exiling Don Carlos and his adherents. In 1840 the queen-regent, finding it impossible to carry on the government without making concessions to public feeling, for which she was indisposed, retired to France, resigning her power into the hands of Espartero, whom she had been previously compelled to summon to the head of affairs. She was declared by a decree of the Cortes to have obtained her majority Oct. 15, 1843. She married her cousin, Don Francisco d'Assisi, Oct. 10, 1846, and reigned until, on Sept. 16, 1868, a revolution broke out, which was speedily followed by the formation of a republican provisional government and the flight of Queen Isabella to France. On June 25, 1870, she renounced her claims to the Spanish throne in favor of her eldest son, the prince of Asturias. After eight years of exile she returned to Spain.

ISABEY, EUGÈNE LOUIS GABRIEL, a French artist; born in Paris, July 22, 1804. He studied art under his father, and in 1830 went on a government expedition to Algiers, where he was able to find many striking subjects for his work. His coloring was fine, and he had much individuality. Among numerous awards he received the cross of the Legion of Honor. Among his pictures, which are *genre*, landscape and marine, several of which are owned by Americans, are *French Hospitality* and *L'Embarquement de Ryter*. He died at Langres, April 26, 1886.

ISAR. See BAVARIA, Vol. III, p. 450.

ISCANDERUN. See SCANDeroon, Vol. XXI, p. 366.

ISE. See JAPAN, Vol. XIII, p. 581.

ISER. See ELBE, Vol. VII, p. 825.

ISHPEMING, a city in Ishpeming township, Marquette County, central north Michigan, 15 miles W.S.W. of Marquette, on the Chicago and Northwestern and the Duluth, South Shore and Atlantic railroads. It contains a foundry, a machine-shop, a blast-furnace and a carriage factory, besides several important public institutions. It is supported mainly by the iron-mines, which are very rich, and there are several iron-furnaces in the vicinity. Population 1880, 6,039; 1890, 11,197; 1900, 13,255.

ISIDORIAN DECRETALS. See CANON LAW, Vol. V, p. 17.

ISINGLASS. See GELATIN, Vol. X, p. 134.

ISIS. See *Religion*, under EGYPT, Vol. VII, p. 717.

ISIS, river Thames. See OXFORD, Vol. XVIII, p. 93.

ISKIMID. See ISMID, Vol. XIII, p. 388.

ISLAM. See MOHAMMEDANISM, Vol. XVI, p. 553.

ISLAMABAD, a town of Kashmir province, northern India, 33 miles S.E. of Seringar, at the head of navigation on the upper Jhelum River, situated on a long, low ridge in the Himalayas. It has three hundred establishments where Kashmir shawls are made. Population, 10,500.

ISLE OF FRANCE. See MAURITIUS, Vol. XV, p. 639.

ISLE OF MAN, a British island in the Irish Channel. In 1891 the population was 55,608. Douglas, its principal town, had a population of 15,719. The principal towns are now all connected by rail. See also MAN, ISLE OF, Vol. XV, pp. 450-454.

ISLE OF PINES. See CUBA, Vol. VI, p. 679.

ISLE OF PINES. See NEW CALEDONIA, Vol. XVII, p. 376.

ISLE ROYAL, an island in the northwestern part of Lake Superior, belonging to Michigan. It is about forty miles long and from eight to twelve broad. Its resources consist chiefly in timber and copper, the copper having been mined from prehistoric times by the Indians. Fish, also, are quite abundant. Its best harbor is Washington Harbor, at its western end. Its population is less than 200.

ISLES OF SHOALS, a group of eight small islands, 10 miles S.E. of Portsmouth, New Hampshire, on the boundary between Maine and New Hampshire, inhabited chiefly by fishermen. On White Island is a revolving light, 87 feet above the level of the sea, and on Appledore and Star islands there are hotels for the accommodation of summer visitors, who resort to the islands to enjoy the sea air.

ISLIP, a township and village of Suffolk County, Long Island, southeastern New York, situated on Great South Bay and the Long Island railroad, 35 miles E. of Brooklyn. It has flour, paper and planing mills, a marine railroad, a shipyard and establishments for putting up canned goods. This is the headquarters of several sporting-clubs, and here fishing and the rear-

ing of trout are important industries. Population 1890, 8,783; 1900, 12,545.

ISMAELIANS OR ASSASSINS. See Vol. II, p. 722.

ISMAIL PASHA, Khedive of Egypt; born in Cairo, Dec. 31, 1830, the son of Ibrahim Pasha.



ISMAIL PASHA.

After Ismail's education at Paris had been finished he returned to Egypt in 1849, his father having died. Said Pasha, viceroy of Egypt in 1856, employed Ismail in various missions to European courts; and in 1862, when Said Pasha visited Europe, he left the administration in charge of Ismail, and when Said Pasha died, in 1863, Ismail succeeded as viceroy. By means of his wealth he obtained, in 1866, from the Sultan of Turkey, the privilege of succession in direct line for his dynasty, and soon afterward he obtained other concessions, which freed him from Turkish supervision, and procured for him the title of "Khedive." He introduced many foreign customs; opened the first Egyptian Parliament in 1866; and pushed his conquests in the valley of the White Nile with the aid of Sir Samuel W. Baker. In 1869 he performed the ceremonies connected with the opening of the Suez Canal. By contracting many loans in England and France he created a public debt of four hundred million dollars, which forced him, in 1875, to sell his shares in the Suez Canal to the British government. In 1876 he suspended payment of interest on the bonds he had issued, and was compelled to relinquish his estates to the creditors. As the army and the people became discontented, especially at his introduction of many foreign officials, and the heavy taxation, Ismail abdicated in 1878 in favor of his son, Tewfik Pasha. He had foreseen this state of affairs, and had secured a large fortune abroad; so in 1879 he left Egypt and lived in different parts of Europe until 1886, when, having visited Constantinople, he was retained in sumptuous captivity. Died in Constantinople, March 2, 1895.

ISNE. See ESNEH, Vol. VIII, p. 547.

ISNIK. Same as NICÆA, Vol. XVII, p. 476.

ISOBAR. See METEOROLOGY, Vol. XVI, pp. 139-143.

ISOGAMY, a term in botany indicating the fact that the sexual process consists of the fusion of similar gametes. The act of fusion is known as *conjugation*, as opposed to *fertilization*, which occurs in *heterogamous* plants; that is, those with dissimilar gametes. The product of conjugation is called a *zygospore*. Only the lower algæ and fungi are isogamous. See figure under CONJUGATION.

ISOGEOSTHERMS, layers or strata within the earth, more or less parallel with its surface, and having each a temperature the same throughout

its own extent, but different from every other. The zones made by isogeothermals, layers terminating in the surface of the earth, are called isogeothermal zones or lines.

ISOLA BELLA. See BORROMEAN ISLANDS, Vol. IV, p. 65.

ISOMERISM. See CHEMISTRY, Vol. V, pp. 550, 551.

ISOMORPHISM. See CRYSTALLOGRAPHY, Vol. VI, p. 675.

ISOPATHY (*ἴσος*, equal; *πάθος*, suffering;) is the treatment of a disease by administering (1) some portion of the body of another individual, either affected with the same disease or associated with its causation; or (2), a portion of the products of the same disease in another individual, e.g., powdered worms as a vermifuge, the hair of a rabid dog in rabies, the matter from a small-pox pustule in variola.\*

The Hindus make their children inhale the fumes from a burning scorpion, on a Sunday or a "new-moon day," so as to make them proof against the effects of the scorpion sting.†

In southern Africa, among some of the tribes, a poison doctor is made by a strong, healthy man taking to bed with him a scorpion, which bites him continually; and, in turn, a large, haired spider, the crowned serpent and the "puff adder." During this time a poison-doctor, made in the same way, attends him, watching the reaction and giving him to drink a solution of his perspiration, and, in bad cases, his urine.‡

The treatment of disease by attenuation of virus was first made a science by Pasteur. By attenuation of virus is meant the cultivation of the poison of disease, by different methods, depriving it of some of its pathogenic qualities, so that a portion of the virus so cultivated, introduced into a susceptible animal or person, produces a modified disease similar to the original and immunes the individual from future attacks of the disease. Pasteur made his experiments with chicken cholera, and found that cultures became attenuated as to their pathogenic power when they had been kept for some time in the laboratory, and that fowls inoculated with cultures suffered a comparatively mild and non-fatal attack, and were subsequently immuned against the pathogenic action of the most virulent cultures, or against contracting the disease by contact with fowls suffering from it. He supposed it was the action of the atmosphere or oxygen.

Attenuation has since been effected by cultivation at certain temperatures, in different culture-media, by exposure to certain antiseptic agents, in the body of a non-susceptible animal, and also by exposure to sunlight and compressed air.

The virus of tetanus and anthrax may be successfully attenuated. The attenuation of the virus of the rabid dog is the basis of the celebrated treatment of rabies by Pasteur.

The treatment of disease by the juice of any of the organs is following out the principle that the

\*Foster's Medical Dictionary.

†Indian Medical Record, April 16, 1896.

‡Vienna Journal of Medicine, 1845.

system takes out of the food whatever of nutriment it needs for its nourishment or fortification against the ravages of disease. If the need is very great, as in disease, the food does not supply enough, and it has long been customary to take from the lower animal the organ corresponding to the individual's need, and give it to him to eat: as, the testicles of the sheep or ox for impotence. The fresh juice, by hypodermic injection, was first used in treatment of disease, but afterward, when it was found that this caused abscesses, an extract was prepared (Dr. Hammond), the dose of which is five (5) drops, hypodermically administered. The most rigid antiseptic precautions are used in the preparation, the time required being more than six months.

Doctor Hammond has prepared cerebrine, from the brain; medulline, from the spinal cord; from the testicle, testine; from the ovaries, ovarine; from the pancreas, pancreatine; from the stomach, gastrine; and from the heart, cardine.

There is also prepared from the thyroid gland a substance called thyroïdine, which seems to have an almost immediate effect upon the disease known as goiter, and is used with success in the treatment of several other diseases. It is now claimed that the active principle is a compound of iodine which has a peculiar effect upon the animal economy. J. THOS. KELLEY, JR.

ISOPERIMETRY PROBLEMS. Same as MAXIMA and MINIMA, Vol. XV, pp. 643, 644.

ISOPELLE. See MOLLUSCA, Vol. XVI, p. 641.

ISOPODA. See CRUSTACEA, Vol. VI, pp. 658, 659.

ISOSPORY, a term in botany sometimes used instead of *homospory*, and indicating that the sporophyte produces similar spores. All the lower plants are isosporous, only certain fern-plants and all seed-plants being *heterosporous*.

ISOTHERMS. See METEOROLOGY, Vol. XVI, pp. 132-137.

ISRAELS, JOSEF, a Dutch painter; born at Gröningen in 1824. He studied in Amsterdam, under Kruseman, and next in Paris, under Picot; and received gold medals of honor in Paris, Brussels and Rotterdam. He also had conferred upon him the Belgian Order of Leopold, and was nominated a member of the French Legion of Honor. His principal paintings are *The Tranquil House*; *The Shipwrecked*; *The Cradle*; *Interior of the Orphan's Home at Katwyk*; *The True Support*; *The Mother*; and *The Children of the Sea* (in the Queen of Holland's collection). In 1873 he exhibited at the French Gallery in Pall Mall *Minding the Flock*, which added considerably to his reputation. Mr. Israels resided in The Hague for many years, and was foreign editor of the *New York World*.

ISSUE IN LAW, a single, material point which is shown by the pleadings in an action, which point is affirmed by one side and denied by the other. An issue may be of fact or law. An issue of fact is the disputed fact upon which the result of a suit depends, and is generally triable by the

jury. An issue of law is one involving the application of the law to the facts as shown by the pleadings. An issue of law is generally raised by a demurrer, and is for the court to decide. The general issue is the plea of a defendant denying in general terms the whole of the plaintiff's declaration, or the material parts thereof.

ISTRIA, DORA D'. See KOLTZOFF-MASSALSKY, in these Supplements.

ITACOLUMITE OR FLEXIBLE SANDSTONE. See *Diamond*, under MINERALOGY, Vol. XVI, p. 381.

ITALY. For general article on the Kingdom of Italy, see ITALY, Vol. XIII, pp. 434-516. The latest and most reliable survey of the kingdom places its area at 110,646 square miles. The population (estimated) in 1899 was 31,667,946. By the new official census, that of 1901, the area was given at 114,610 square miles, and the population was estimated at 35,000,000. To its original territory, however, must now be added its African colonial possessions of Assab and Massowah on the Red Sea, the Dahlak archipelago, and a strip of territory for some distance inland from Massowah, and along the coast from Ras Kasar (18° 2' N) to the southern limit of the sultanate of Rabeita, a territory which, under the general name of Eritrea, has an area of about 88,500 square miles, and a population of about 450,000. In 1889, the negus, Menelik of Abyssinia, acknowledged the protectorate of Italy, but renounced it in 1896. Italy also claims a portion of Somaliland, east Africa, of unknown extent, lying between British Somaliland, on the north, and British East Africa on the south.

On April 22, 1892, however, a somewhat more cautious and conservative colonial policy was inaugurated, when the Italian ministry decided to limit the national possessions in Africa. For an account of the disastrous results following Italy's attempt at colonization, see ABYSSINIA, in these Supplements.

In 1890, in continental and peninsular Italy, the population included, in Piedmont, about 120,000 French and some 3,000 of Teutonic origin, and in southern Italy at least 60,000 of Albanian and 20,000 of Greek origin. In Sardinia there are from 7,000 to 8,000 of Spanish descent. The emigration from Italy is considerable, the number in 1894 being 225,346; in 1895, 293,181; and in 1896, 307,482. In 1897 the number was 299,899; of these, 125,310 went to other European countries, 47,000 to the United States, 80,984 to Brazil, and 39,538 to other South American countries.

The urban population of Italy is upon the increase. Rome in particular shows a remarkable increment within the last decade. Numbers of magnificent modern residences have been erected, while the neighborhood of the city is dotted with splendid villas and suburban residences. The foreign population of Rome is continually receiving additions from other countries. It has become, more than ever, the objective point of the student of the fine arts, to which almost every country of the eastern and western hemispheres contributes its annual quota.

**GOVERNMENT.** The deputies of the lower house are chosen according to the electoral law of March 28, 1895, by ballot, by all citizens who are 21 years of age, can read and write, and possess one or other of the following qualifications: a certain standard of elementary education; or pay at least 19.80 lire in direct taxation; or, if peasant farmers, pay at least 500 lire annually for rent; or are managers of farms on which at least 80 lire are paid in direct taxes; or pay an annual rent as lodger or leaseholder of from 150 to 400 lire. Members of academies, professors, persons who have served under arms for two years, and other classes are qualified to vote by their position. In the beginning of 1897 there were 372 senators and 508 deputies. The number of enrolled electors in 1896 was 2,120,909, exclusive of 39,029 temporarily disfranchised on account of military service. Money bills must originate in the lower house. The Parliaments are quinquennial, but may be dissolved by the sovereign at any time. The ministers, 11 in number, are not necessarily members of either house. Should the King dissolve Parliament, he is bound to order new elections and convoke a new meeting within four months. It is incumbent upon the executive to call the Parliament together annually. The ministers have the right to attend the debates of both the upper and the lower house; but they have no votes unless they are members.

The executive power is exercised, under the King, by a ministry, divided into the following 11 departments: The Presidency of the Council and the Ministry of the Interior, the Ministry of Foreign Affairs, of Finance, of the Treasury, of Justice and Ecclesiastical Affairs, of War, of Marine, of Commerce, Industry, and Agriculture, of Public Instruction, of Public Works, and of Posts and Telegraphs. The government of the provinces, with a prefect at the head of each, is very much the same as in France.

**THE ARMY.** By the law of June 28, 1897, the army consists of the permanent army, the mobile militia, and the territorial militia. Personal military service is compulsory on all citizens from their 20th to their 30th year.

The annual levies are divided by lot into three categories. 1. In the first category, in the permanent army, the non-commissioned officers and carabinieri serve five years under arms, and four years with unlimited leave; in the territorial militia they serve ten years, with unlimited leave. 2. Those in this category remain eight or nine years in the permanent army, with unlimited leave, three or four years in the mobile militia, and seven years in the territorial militia. 3. Those in the third category do not join either the permanent army or the mobile militia, but serve their nineteen years in the territorial militia, with unlimited leave. The strength of the Italian army in June, 1897, was as follows:

*Permanent Army:* Officers under arms, 14,324; officers on unlimited leave, 9,811; troops under arms, 237,660; troops on unlimited leave, 556,984; total under arms, 251,984; total on unlimited leave, 566,795.

*Militia:* Mobile officers, 1,214; mobile troops, 475,972; territorial officers, 10,793; territorial troops, 1,992,681; total territorial, 2,003,474; grand total for the army, 3,299,439.

The army consists of 12 army corps, as follows: 1. Turin; 2. Alexandria; 3. Milan; 4. Placentia; 5. Verona; 6. Bologna; 7. Ancona; 8. Florence; 9. Rome; 10. Naples; 11. Bari; 12. Palermo. A special African corps, partly Italian and partly native, was organized in 1887. The Italian army is provided with the Vetterli repeating-rifle and sword-bayonet.

There is a staff college and a school for engineer officers at Turin, others for infantry and cavalry officers at Modena and Parma, for cavalry officers at Pinerolo, and for the sanitary corps at Florence; and military colleges at Milan, Florence, Rome, Naples, and Messina. A chain of fortresses has been erected along the northern frontier. There are numerous forts and batteries in the basin of the Po and along the coast. Rome is protected by a circle of 15 forts.

Under the terms of the tripartite agreement, called the triple alliance, between Austria, Germany, and Italy, the Italian government is bound, equally with its allies, to contribute to the defense of allied territory in case of its invasion by hostile troops, receiving, in its turn, the coöperation of the Austrian and German arms.

**THE NAVY.** For purposes of local naval administration and defense the Italian littoral is divided into three prefectures: 1. Spezia; 2. Naples; 3. Venice. In 1898 the navy consisted of 10 first-class battleships, 2 second-class, 2 third-class; 1 port-defense vessel; 2 first-class, 5 second-class, and 10 third-class cruisers; 17 torpedo gunboats; 10 first-class, 103 second-class, and 73 third-class torpedo-craft—a total of 235.

**MERCANTILE MARINE.** On Dec. 31, 1896, there were 6,002 sailing-vessels and 351 steam-vessels; in all, 6,353. In 1896 there entered Italian ports 89,808 Italian vessels, and 10,807 foreign vessels; in all, 100,615. There cleared from Italian ports 89,371 Italian vessels, and 10,787 foreign vessels; in all, 100,158.

On Dec. 31, 1896, the number of boats and vessels employed in fishing was 23,096, with an aggregate tonnage of 64,677. At the same date there were 77,109 fishermen, of whom 6,648 were engaged in deep-sea or foreign fishing. The value of the fish caught in 1896 (excluding foreign fishing) was estimated at 14,948,884 lire; the value obtained from tunny-fishing was 1,780,985 lire, and from coral-fishing, 1,013,700 lire.

**INTERNAL COMMUNICATIONS.—Railways.** A large portion of the Italian railways belong to the state, but in accordance with a law of April 27, 1885, the working of the state lines has been transferred to private enterprise. The contracts are for sixty years, but at the end of twenty and forty years they may be terminated.

On Jan. 1, 1893, there were 5,346 miles of state railway, 96 miles jointly state and private, and 3,216 miles of private railway; in all, 8,658 miles. In 1892 the total receipts were 253,135,975 lire,

of which 98,912,077 lire were for passenger traffic. In the same year the expenses were 174,151,182 lire.

Up to Jan. 1, 1891, there had been constructed 2,539 kilometers of tramway in the principal cities.

*Waterways.* There are few large rivers, and of these only a small number are navigable. There are, however, numerous canals, both for navigation and irrigation. The length of the navigable canals is 655 miles. The most notable of these are the Canal Cavour in Piedmont, the Grand Canal in Lombardy, besides smaller ones in Pavia, Mantisana, Venetia, and Emilia.

*Posts and Telegraphs.* During the year ending June 30, 1896, there were transmitted 217,237,611 letters and postal-cards, to which must be added 40,495,849 government official letters. There were sent also 5,361,337 manuscript papers, and 249,761,929 periodicals and other printed matter. The money orders numbered 10,484,037; value, 873,287,982 lire. There were 7,435 post offices and collecting-boxes.

The public telegraph service is a monopoly of the government, certain concessions, however, being made to the railway and tramway companies. In 1894, the length of line and wire on land was, in English miles: lines, 25,449; wires, 98,318.

During the year ending June 30, 1894, there were dispatched from the government and railway telegraph offices 7,214,927 private telegrams inland; and there were sent or received from abroad 1,995,312 telegrams. The receipts amounted to 66,438,946 lire, and the expenses to 55,018,028 lire. Number of state offices, 3,549; other offices, 2,236.

There are 17 miles of railway from Massowah to Saate, and 16 between other centers. In 1895-96 the post office at Massowah forwarded 181,925 letters and postal-cards, and 18,976 manuscripts. There is a telegraph line of 319 miles from Massowah to Assab, and one of 62 miles from Assab to Perim. In 1895-96 19,329 messages were sent.

*COMMERCE AND MANUFACTURES.* In 1894 Italy ranked eighth among the great continental nations in commercial supremacy. Her foreign trade is facilitated by her extensive seaboard, and has lately received an extraordinary impulse through railroad connections with countries beyond the Alps, by means of those gigantic engineering works, the St. Gothard and Mt. Cenis tunnels, thus connecting Italy with central and western Europe. The imports of the kingdom for 1897 (excluding gold, coined silver, and goods in transit) were 1,192,138,168 lire, and the exports 1,092,719,241 lire. The imports of the precious metals for the same period were 8,676,200 lire, and the exports, 23,096,400 lire.

Partly because of the high cost of fuel, Italy does not rank among the great manufacturing countries of Europe, but in some branches of trade her productions are of considerable importance. The manufacture of thread and cotton tissues shows a steady advance, as does also the spinning and weaving of wool. Machinery, manufactured principally at Turin and Milan, was valued at over \$20,000,000 in 1892. Manufac-

tures of glass and ceramics, \$12,500,000. About 6,000,000 tons of wheat and maize are ground annually. The manufacture of tobacco is a government monopoly. In 1895 the annual production exceeded 40,000,000 pounds. The output of the tanneries is estimated at \$20,000,000, and there is a considerable export of gloves. There are numerous paper-mills in Piedmont, Lombardy, and Campania, and factories of straw hats, the principal being at Florence, and of cloth, silk, and felt hats, in Piedmont especially.

*AGRICULTURE.* The vast majority of the population of Italy finds employment in agricultural pursuits. Of the entire area of the kingdom, 70.6 per cent is returned as productive, the unproductive tracts embracing only the higher mountain districts and the marshes; and even these latter are being gradually drained. The production of cereals falls below the needs of the population. Hence large importations of wheat and maize are made annually.

In 1890 Italy had 5,000,000 cattle, 6,900,000 sheep, 1,800,000 goats, 1,800,000 swine. In 1897 Italy exported 37,226 and imported 17,850 cattle; exported 38,603 and imported 8,134 sheep; exported 887 and imported 5,152 goats; exported 40,066 and imported 3,779 swine. The wool product is not, however, sufficient for consumption, the imports in 1897 being valued at 31,151,690 lire; with little or no export.

Silk-culture, though flourishing most extensively in Piedmont and Lombardy, is carried on all over Italy. In 1895 there were 550,048 persons employed in rearing silk-worms, and 172,000 skilled and other workers (nine-tenths of whom were women and children) were employed in the treatment and manufacture of silk.

The total weight of the cocoon harvest was in 1890, 89,866,800 pounds; 1891, 85,494,748; 1892, 69,283,000; 1893, 104,991,900; 1894, 88,184,000; 1895, 90,534,400; 1896, 87,656,800; 1897, 80,797,200.

In the census of December 31, 1881, there were 5,024,826 males of 15 years of age and upwards described as engaged in agriculture. The entire agricultural population, male and female, of 15 years and upward, was thus about 10,000,000. According to the last census the number of persons of 15 years of age and upward was to the whole population in the ratio of 678 to 1,000; thus the whole agricultural population was computed to be 14,900,000.

The forest area is about 10,109,710 acres, and the annual yield is valued at 88,000,000 lire. The average value of the total yield from land and animals is: Cereals, fibres, wine, fruit, etc., 2,639,000,000 lire; animals, wool, milk, cocoons, etc., 1,424,000,000 lire; forest yield, 88,000,000 lire; total 4,151,000,000 lire.

*MINERALS.* There is a singular lack of deposits of bituminous coal in Italy, nor is iron to be found save in a very few localities. A small quantity of anthracite coal and about 300,000 tons of lignite are mined every year, most of the latter being found in Tuscany and Umbria.

Peat is largely used for fuel, and is found in many districts. Nearly all the iron is mined in the island of Elba, and some in Lombardy and Piedmont. The great mineral product of Italy is sulphur, which represents nearly half of the annual value of all minerals mined in the kingdom; of this, nearly nine-tenths is obtained in Sicily. The number of persons employed in this industry was 24,775 in 1896. The value of the mineral products was in 1893, 57,906,180 lire; in 1896, 48,969,105 lire. In addition to these industries must be mentioned the quarrying of marble, granite, and alabaster, valued at nearly \$5,000,000 annually, and employing some 30,000 men.

**FINANCES.** In addition to the cost of the war with Austria and the debts of the old Italian states, the young kingdom has had to face the extraordinary expenses connected with the placing of its army upon a suitable war footing and the reconstruction of its navy. In addition to this, it has had to meet the expenses entailed upon it by its signature of the tripartite agreement, which compels the government to keep itself in a position to assist its allies effectually. In the year 1898-99 the revenue was 1,696,791,355 lire; and the expenditure 1,686,793,409 lire.

The capital of the consolidated and redeemable debt amounted to \$2,393,431,450 on July 1, 1897.

There is no national bank in Italy. There are three banks authorized to issue notes.

In 1895 there were 950 coöperative credit societies and popular banks, with assets at the end of 1891 amounting to \$150,814,531, and liabilities \$149,157,889; 150 ordinary credit companies, with assets \$345,382,376, and liabilities \$340,788,139. Eleven agrarian credit companies had assets \$9,962,069, and liabilities \$9,951,807. There are 10 *crédit foncier* companies with assets \$214,263,621, and liabilities in 1894, \$212,683,698.

The post-office savings banks have been in operation since Jan. 1, 1876. In these in 1895 the total deposits were 536,634,812 lire, by 3,013,004 depositors. Private savings banks are subject to certain statutory rules and to government inspection.

There are several taxes which, in the opinion of leading financiers, should be done away with. Some of the state monopolies are also viewed with disfavor by the people. However, the more objectionable imposts have been removed, such as the grist tax. In 1883 the forced paper currency was withdrawn from circulation.

**Money, Weights, and Measures.** The metric system of money, weights, and measures of France has been adopted, the names only being slightly altered, the franc changing into the lira, divided into 100 centesimi, the kilogramme into the chilogramma, the mètre into the metro, the hectare into the ettaro.

**Religion.** The Roman Catholic Church is, nominally, the ruling state religion of Italy; but many acts of the legislature, passed since the establishment of the kingdom, have subordinated the power of the church and the clergy to the authority of the civil government and secured perfect religious freedom to the adherents of all

creeds without exception. However, scarcely any other creed exists, as yet, but Roman Catholicism. At the census of 1881, of the total population about 62,000 were Protestants and 38,000 Jews. The relation of the Holy See to the kingdom is set forth in a royal decree of Oct. 9, 1870, which declared that "Rome and the Roman provinces shall constitute an integral part of the Kingdom of Italy." The Pope was acknowledged supreme head of the church, preserving his former rank and dignity as a sovereign prince.

**Social Conditions.** The sanitary condition of nearly three fourths of the entire population of Italy continues most deplorable. There is lack of drinking-water in the houses and an almost total absence of sewers in the cities. In such cases the prevalence of disease is not to be wondered at. Matters, however, are improving gradually, and deaths from the *pellagra*, a wretched complaint superinduced by insufficient diet, are less frequent than in former years. The condition of women and young girls is not what could be desired. Of 11,290,000 females in Italy over the age of nine years nearly two millions are employed in industrial labor and over three millions are engaged in agricultural pursuits. The figures regarding juvenile labor—below the age of 15—are still more striking, as showing at how much lower an age Italian girls go to work than do Italian boys.

**Education.** Education is under a Minister of Public Instruction. Nearly \$9,000,000 has been set aside by the state annually for education, and to this the communes and provinces add \$12,500,000. At the formation of the kingdom the general ignorance was incredibly profound, but notable progress has been made of late in the education of the masses of the people. Although possessed of many universities and learned societies of almost world-wide celebrity, since the stormy times of her struggle for national life Italy has produced few men who have achieved eminence in literature. The name of the poet Carducci is the only one of great distinction.

In all cases the proportion of illiterate women is greater than that of men. The notion of intellectual equality between the sexes is confined to a few earnest reformers, and there is much less adequate provision for the higher education of girls, although the universities nominally are open to women as well as men. The convent schools teach mainly embroidery and devotions, and the government and superior schools are not satisfactory. In 1861, however, a good high-school for girls was opened at Milan and its success has led to the establishment of many similar schools in other towns. Primary education is compulsory, and separate boys' and girls' schools are to be found in all but the very poorest communes. From 1861 to 1895 the number of pupils (male and female) in these elementary schools increased from 885,152 to 2,585,000; in 1896 there were 50,526 such schools open, besides 9,000 private elementary schools. There were also 2,813 asylums for children, many of them con-

ducted on the kindergarten system, with 317,117 children; and there were 4,687 night-schools, with 151,369; and 5,886 Sunday-schools with 169,609 pupils enrolled, besides 148 normal schools with 24,152 pupils. In 1896 the gymnasiums numbered 708 (255 episcopal and 141 private), with 59,578 scholars; the lyceums, 332 (124 episcopal and 55 private), with 17,689 pupils. Also, there were 455 technical schools and institutes (84 private), with 47,467 students; 21 mercantile marine schools (19 governmental), with 917 pupils; and 22 collegiate institutions and superior special schools, with 3,481 students and 200 "hearers." Finally, there are in Italy 21 universities, 17 of them governmental and four "free"—i. e., maintained by the provinces and communes; the total number of students and "hearers" was 22,440 in 1897-98, besides 203 who were entered at three lyceums that provide a university course.

The principal towns of Italy are Naples, Rome, Milan, Turin, Palermo, Genoa, Florence, Venice, Bologna, Messina, Catania, and Leghorn. The late King Humbert I, son of Victor Emmanuel II, who succeeded to the throne Jan. 9, 1878, was assassinated at Monza, July 29, 1900, by an Italian anarchist known in Paterson, N. J., as Gaetano Bresci. His death was profoundly deplored. He was at once succeeded by his only son, then Prince of Naples (born Nov. 11, 1869), who now reigns as Victor Emmanuel III. The new Queen is Princess Helena (born Jan. 8, 1873), daughter of Nicholas, Prince of Montenegro.

ITASCA LAKE, Beltrami County, Minnesota, the source of the Mississippi River. Its elevation is 1,575 feet, and it is 2,555 miles from the Gulf of Mexico. The Mississippi here leaves the lake as a stream 12 feet wide and two feet deep.

ITHACA, a village and the capital of Gratiot County, central Michigan, on the Ann Arbor and the Detroit, Lansing and Michigan railroads. It contains a furniture factory, a foundry, iron-works and a creamery, and is supplied with city water and electricity. Population 1900, 2,020.

ITHACA, a city and the capital of Tompkins County, southwestern central New York, situated at the south end of Cayuga Lake, 37 miles S. of Auburn, on the Elmira, Cortland and Northern, the Delaware, Lackawanna and Western and the Lehigh Valley railroads. Ithaca is built partly on an alluvial plain and partly on the slopes of high hills which inclose that plain on all sides except the north and are nearly six hundred feet higher than the lake. The town contains many public buildings, and also manufactories of flour, paper, carriages, farming implements, iron castings, machinery, clocks, spokes and hubs, horse-rakes, glass, leather, musical instruments and fire-arms. The city has a public library, water-works, electric lights and street-railways. It is the seat of Cornell University (q.v.). Population 1880, 9,105; 1890, 11,079; 1900, 13,136.

ITO, COUNT, a Japanese statesman; born in the Province of Chosu, in 1840. A secret journey to Europe convinced him of the superiority of western civilization, and since that time he has been one of

the leaders in westernizing his native land. In 1871 he visited the United States to investigate the coinage system, and upon his return to Japan he assisted in establishing the mint at Osaka. On a second trip to Europe, in 1880, he was favorably impressed with the German methods of government, and his attempts to introduce them into his own country have given him the name of the Japanese Bismarck. In 1886 he assumed the leading place in the Japanese Cabinet, and under the title of Minister President of State, instituted sweeping economical reforms, and during the next two years everything was done to make Japan the Asiatic counterpart of the German Empire. A reaction in 1888 resulted in Ito's retirement from the Premiership, to which, however, he was recalled in 1892. In the war with China, in 1894-95, he played a leading part, being Premier of the empire and High Admiral of the Japanese fleet. In recognition of his services he was made a marquis. An unsuccessful attempt to assassinate him was made in 1895. He retired to private life in August, 1896.

ITURÆA, a small province on the northeastern border of Palestine, lying along the base of Mount Hermon. The district, the modern name of which is Jedur, contains 38 towns and villages.

ITYS, in Greek mythology, son of Procne and Tereus. After the birth of Itys, Tereus concealed Procne in the country, that he might marry her sister Philomela, whom he deceived by saying Procne was dead. At the same time he deprived Philomela of her tongue. She, however, soon found out the truth, and made it known to her sister by a few words which she wove into a pepus. Procne thereupon killed her own son, Itys, and served up the child's flesh in a dish before Tereus. She then fled with her sister. When Tereus was about to overtake the fleeing sisters, the gods, in answer to their prayer, changed all three into birds: Tereus into a hoopoe or hawk, Philomela into a swallow and Procne into a nightingale, which from that time to this has never ceased to cry out "Itys, Itys."

IUKA, a post village, capital of Tishomingo County, northeastern Mississippi, situated on the Memphis and Charleston railroad, 115 miles from Memphis, Tennessee. It has an institute for women, an academy for men, and valuable mineral springs. Here occurred an indecisive battle between Generals Rosecrans and Price on Sept. 19, 1863. Population 1890, 1,019; 1900, 882.

IVANHOE TUNNEL. The Ivanhoe tunnel, the construction of which was begun in August, 1890, runs from Busk, a hamlet 15 miles W. of Leadville, Colorado, through the backbone of the Rocky Mountains to Ivanhoe, a village on the west side of the range. The length of the tunnel is 9,400 feet, being only surpassed in America by the Hoosac and Boulder, the latter being 300 feet longer. It is 21 feet high and 15 feet wide in the clear. Where the Ivanhoe tunnel enters the mountain at Busk the altitude is 10,800 feet. Owing to the high altitude, doors are placed at each end to keep out the snow, and the tunnel itself, for several hundred feet from each end, is heated by steam. The distance between Busk and Ivanhoe is lessened seven miles.

**IVES, LEVI SILLIMAN**, an American Protestant Episcopal clergyman; born in Meriden, Connecticut, Sept. 16, 1797. He served in the War of 1812, and afterward entered Hamilton College; studied for the Protestant Episcopal ministry, and after his ordination had pastorates in Batavia, New York, and in Philadelphia and Lancaster, Pennsylvania. In 1831 he was elected bishop of North Carolina, where he became deeply interested in work among the negroes. On Christmas day, 1852, while in Europe, Bishop Ives made formal submission to the Pope at Rome and became a Roman Catholic. On his return to the United States he lectured in the Catholic schools of New York City, and established the Catholic protectorate of destitute children. He wrote a *Catechism*; *Manual of Devotion*; and *The Trials of a Mind in its Progress to Catholicism* (1853). He died in New York City, Oct. 13, 1867.

**IVISA, IVIZA OR IVICA**, the most southerly of the Balearic Isles. See **BALEARIC ISLANDS**, Vol. III, p. 278.

**IVORY-BLACK**, a black pigment prepared from calcined ivory or bones. See **IVORY**, Vol. XIII, p. 524.

**IVRY-LA-BATAILLE**. See **IVRY-SUR-SEINE**, Vol. XIII, p. 525.

**IXCAQUINTLA**, the chief town of the Chucon Indians, situated in the southern part of the state of Puebla, Mexico, 10 miles S.E. of Tepeji. It is noted in Mexican history as the scene of a battle, fought Jan. 1, 1817, between Mexican insurgents under General Mier of Teran and Spanish troops under La Madrid. There are extensive remains of antiquity in the vicinity. Population, 5,000.

**IXTÁCCIHUATL**, a Mexican mountain, 15,700 feet high. See **POPOCATEPETL**, Vol. XIX, p. 512.

**IXTAPALAPA**, a town of Mexico, 10 miles S.E. of the capital. It was a large and important city at the time of the conquest of Mexico, and was celebrated for its splendid gardens belonging to the Aztec emperors. Few traces of its former importance now remain. Near the town is the Cerro de la Estrella, or Star Hill, where the Aztec priests performed peculiar religious rites. Remains of the ancient altar and temple still exist on the summit of the hill.

**INTLILXOCHITL, FERNANDO DE ALBA**, a Mexican historian; born in Texcoco about 1568; a lineal descendant of the ancient emperors of Texcoco, who devoted himself to the collection and translation of hieroglyphic records concerning his ancestors. Comparatively little was known of his writings until their importance was made known by Calegero and Humboldt. His history was divided into thirteen books, and covered the period from the earliest times to the destruction of the Mexican Empire. Prescott, who made use of these works in his *History of Mexico*, calls the author the Livius of Anahuac. He died at Texcoco, in 1648.

**IYÉYASU, TOKUGAWA**. See **JAPAN**, Vol. XIII, p. 583.

**IZABAL**, a town, also a lake. Sometimes called Dulce. See **GUATEMALA**, Vol. XI, pp. 239-241.

**IZABAL DE BRAGANÇA**. See **EU, COMTE D'**, in these Supplements.

**IZALCO**. See **SAN SALVADOR**, Vol. XXI, p. 268.

**IZAMAL, PYRAMID OF**. See **YUCATAN**, Vol. XXIV, p. 759.

**IZARD, RALPH**, an American statesman; born near Charleston, South Carolina, in 1742; educated at Cambridge, England. He was a man of large wealth, and pledged his estate to aid in carrying on the war for independence against England. In 1776 Congress appointed him a commissioner at the court of the Grand Duke of Tuscany, and in 1780 he returned to the United States. It is said that no one had the confidence of Washington to a higher degree than Izard, and that he was largely instrumental in securing the appointment of General Greene to the Southern army. In 1782-83 he was a delegate to the Continental Congress, and from 1789 to 1795 was a United States Senator from South Carolina. His *Correspondence from 1774 to 1784* was published in 1844. He died in South Bay, near Charleston, May 30, 1804.

**IZDUBAR**. See **ZODIAC**, Vol. XXIV, p. 792.

**IZUCAR**, a town of Mexico, state of Puebla, at the foot of the volcano Popocatepetl, in a fine sugar district. It is sometimes called Matamoras Izucar, in honor of the Mexican patriot of that name. Population, about 12,000.



# J

## JABLOCHKOFF CANDLE—JACKSON

**JABLOCHKOFF CANDLE.** See LIGHTING, Vol. XIV, p. 632.

**JABNEEL.** Same as JAMNIA, Vol. XIII, p. 563.

**JACARE ALLIGATOR.** See CROCODILE, Vol. VI, p. 594.

**JACK,** a name given to one of the bread-fruit trees, *Artocarpus integrifolia*, of the family *Moraceæ* or mulberries. It is a native of the South Sea Islands, and is cultivated for its fruit in tropical countries. It has a large spherical inflorescence, whose bracts and perianthis and axes become fleshy and united into one pulpy mass.

**JACKASS, LAUGHING.** See KINGFISHER, Vol. XIV, p. 82.

**JACK-O'-LANTERN OR IGNIS FATUUS.** See PHOSPHORESCENCE, Vol. XVIII, p. 813.

**JACK-RABBIT,** the popular name of a certain very large rabbit inhabiting the Western states. The animals have immense ears, sometimes six inches long. These rabbits are noted for their great speed, and the great leaps which they can make. *Lepus callosus* and *L. Californicus* are the most common species.

**JACKS.** Mechanical and hydraulic jacks are used universally for raising heavy weights that are situated inconveniently for management with cranes, derricks, or the like. The simpler forms are the screw-jack and the rack-and-pinion jack, which have a column between two and three feet high, and a lever for elevating a sliding piece by the mechanism named. They are manufactured only in cheap forms since the introduction of the hydraulic jack, which is vastly superior. This has a stout upright cylinder set in a base, which also usually contains the reservoir. Within the cylinder slides the ram, which is raised by pumping water under it. If the lower face of the ram be 50 square inches, and the water be pumped in through a hole of one half square inch capacity, it is apparent that the man who operates the pump can raise a weight 200 times as great as the power he exerts on the pump-lever, less the friction involved. Sometimes the pump is placed in the same column with the ram, and sometimes in a side position. A jack is of small size compared with the force which it develops. A fifty-pound jack will lift four or five tons, and a jack made to lift 40 tons weighs 300 to 350 pounds. A laborer of fair strength will raise ten tons one foot in one and a half minutes, with a hydraulic jack. Dudgeon's latest improved hydraulic jack appears from the outside to be a simple upright cylinder, with a base, handles and a pump-lever. The pump-lever is attached to the head of the ram, which is a cylinder sliding within another cylinder. When the ram is down the liquid is within it, but the operation of the lever pumps the water through a valve in the bottom of the ram into the outer cylinder, thus raising the ram. The piston and valves are

protected with packing, like those of a steam cylinder. The side-pump jack is preferred where there is little room for its use, as it stands about five inches lower for the same capacity. It is made with a lowering-valve on the reservoir, for convenience in bringing the ram back to its lowest position after a hoist.

C. H. COCHRANE.

**JACKSON,** a village and the capital of Amador County, northern central California, 55 miles S. E. of Sacramento, at the confluence of the north, middle and south forks of Jackson Creek. It has quartz-mills, and the chief occupations are gardening, farming, quartz and placer mining. The nearest station is 10½, 10 miles to the east, on the Southern Pacific railroad. Pop. of county (1900), 11,116.

**JACKSON,** a village and the capital of Butts County, northern central Georgia, on the Southern railroad, 40 miles S. E. of Atlanta. It has an academy, an oil-mill, lumber-mills, and it ships considerable cotton. Population 1900, 1,487.

**JACKSON,** a village of East Feliciana Parish, western Louisiana, on Thompson's Creek and on the Jackson railroad, 26 miles N. of Baton Rouge. It is the seat of Centenary College (Methodist Episcopal), founded in 1825, and the State Insane Asylum, and an institute for young ladies. Population 1890, 1,276; 1900, 2,012.

**JACKSON,** a city and the capital of Jackson County, central southern Michigan, situated on Grand River, 76 miles W. of Detroit, 37 miles S. of Lansing, on the Grand Trunk, the Lake Shore and Michigan Southern and the Michigan Central railroads, eight branches of which radiate from here. It contains flouring-mills, machine-shops, foundries, sash-and-blind factories, planing-mills, breweries, manufactories of furniture, agricultural implements, carriages and wagons, railroad-cars, pumps and cigars, and also has several coal mines. It has electric lights and street-railways. Its manufactories have an aggregate capital of \$5,000,000, and their annual products average \$5,100,000. They employ, on an average, 3,250 hands. Population 1890, 20,779; 1900, 25,180. See JACKSON, Vol. XIII, p. 533.

**JACKSON,** a village and the capital of Jackson County, southwestern Minnesota, on the Des Moines River, and the Chicago, Milwaukee and St. Paul railroad, 53 miles S. S. W. of New Ulm. It has grist-mills, a wagon factory and flour-mills. It is in a wheat-growing district. Population 1900, 1,756.

**JACKSON,** a city of Hinds County, southwestern central Mississippi, the state and county capital. It is on the Illinois Central and the Alabama and Vicksburg railroads, whose lines run in six directions from the city. Its newer institutions include the Jackson Collegiate Academy, Millsaps College, the Mary Holmes Industrial Seminary for Colored Girls and a library. It is situated in a cotton-grow-

ing region. A large part of the city was destroyed during the Civil War. Population 1890, 5,920; 1900, 7,816. See also JACKSON, Vol. XIII, p. 533.

JACKSON, a village and the capital of Jackson County, southern Ohio, on the Ohio Southern and the Baltimore and Ohio Southwestern railroads, 30 miles N.E. of Portsmouth. It is an iron and coal-mining region, and has iron furnaces, rolling-mills, foundry and machine-shop, planing, woolen and flour mills. Population 1890, 4,320; 1900, 4,672.

JACKSON, a city and the capital of Madison County, western Tennessee, on the south fork of the Forked Deer River. The Mobile and Ohio, the Illinois Central and the Norfolk and Western railroads run through the city. It is the seat of the Southwestern Baptist University, the Memphis Conference Female Institute, and has a court-house, a bank, an opera-house, a colored female seminary, gas-works, spoke, carriage and ice factories, engine and boiler works, woolen, flour, cottonseed-oil and planing mills, an iron foundry and railroad workshops. Cotton is the chief article of export. Population 1890, 10,039; 1900, 14,511. See JACKSON, Vol. XIII, p. 533.

JACKSON, FORT, a fortification, 78 miles S. of New Orleans, at the Plaquemine Bend, which, in conjunction with Fort St. Philip, defends New Orleans from attack by way of the river. It was built mainly from 1824 to 1832, but since 1841 has been modified and repaired extensively. One of Admiral Farragut's great naval exploits during the Civil War was the capture of these works.

JACKSON, ABRAHAM REEVES, an American surgeon; born in Philadelphia, June 17, 1827. After completing his education at the Pennsylvania Medical College, he practiced at Stroudsburg until 1870, when he removed to Chicago, and founded the Woman's Hospital of the State of Illinois, of which he became surgeon-in-chief. In 1872 he was elected to the chair of diseases of women, a position which he held until elected president of the College of Physicians and Surgeons, at Chicago. He published a large number of valuable articles on diseases peculiar to women. Died in Chicago, Nov. 12, 1892.

JACKSON, CHARLES, an American jurist; born at Newburyport, Massachusetts, May 31, 1775; graduated from Harvard; studied law under Chief-Justice Parsons. In 1796 he was admitted to the practice of law in Newburyport, Massachusetts, and in 1803 removed to Boston, where he attained a high rank at the bar. From 1813 to 1824 he was judge of the Massachusetts supreme court, and in 1833 was chairman of a commission to codify the state laws, and drew up the second part of the *Revised Statutes*. In 1828 he published a treatise on *Pleadings and Practice in Real Actions*. He died in Boston, Dec. 13, 1855.

JACKSON, CHARLES THOMAS, an American scientist; born at Plymouth, Massachusetts, June 21, 1805. After studying medicine in America and Europe he settled in Boston, Massachusetts, and began the practice of his profession. In 1838 he opened a laboratory for research in analytical chemistry, the first of its kind in the United States. In 1836 he was made state geologist of Maine, in 1839 of Rhode Island, and in 1841 of New Hampshire,

retaining the last office until 1844. In 1847 Congress appointed him to survey the mineral lands of Michigan, but, after two years devoted to this work, he was displaced in consequence of political changes. Dr. Jackson made many important scientific discoveries, one of the most valuable being that of etherization, for which he received a prize of 2,500 francs from the French Academy of Science. There have been several other claimants for the honor of having made this discovery, among them Horace Wells and W. G. T. Morton. He published many papers and reports, besides a *Manual of Etherization, with a History of its Discovery* (1861). He died at Somerville, Massachusetts, Aug. 29, 1880.

JACKSON, GEORGE THOMAS, an American dermatologist; born in New York City, Dec. 19, 1852; studied medicine at the College of Physicians and Surgeons in New York City, and later at Berlin, Vienna and Strasburg; was appointed chief of clinic and instructor in dermatology in the College of Physicians and Surgeons in 1887; and was a member of numerous medical societies. He published valuable articles on *Diseases of the Hair and Scalp* (1887); *The Ready Reference Handbook of Diseases of the Skin* (1892).

JACKSON, HELEN MARIA FISKE, an American authoress, a daughter of Professor Nathan W. Fiske; born at Amherst, Massachusetts, Oct. 18, 1831. She was educated at the Ipswich (Massachusetts) female seminary, and in 1852 became the wife of Major E. B. Hunt, of the United States Engineers. She was left a widow in 1863, and in 1875 she contracted a second marriage with William S. Jackson, of Colorado Springs, Colorado, where much of her after-life was spent. In 1879 she became interested in the treatment of the Indians by the United States government, and in 1883 was appointed special commissioner to examine into the condition of the Mission Indians of California. Her literary productions, over the signature of "H. H.," began to attract attention about 1870, and soon won considerable popularity. Among her works are *Verses by H. H.* (1871); *Hetty's Strange History* (1877); *A Century of Dishonor* (1881); *Romona* (1884). She died at San Francisco, California, Aug. 12, 1885.

JACKSON, HENRY ROOTES, an American soldier; born at Athens, Georgia, June 24, 1820; studied at Princeton and afterward at Yale, where he graduated; after being admitted to the bar he practiced law in his own state; served with distinction as colonel in the Mexican War. In 1854 he was appointed *chargé d'affaires* at Vienna, Austria, and afterward was raised to the rank of minister resident at the same court, a position which he held until 1858. During the Civil War he served as brigadier-general in the Confederate army until captured and taken to Johnson's Island, where he remained till the close



HELEN M. F. JACKSON.

of the war. In 1885-86 he was United States minister to Mexico. He wrote *Tallulah, and Other Poems* (1850), which met with popular favor. Died at Savannah, Ga., May 23, 1898.

JACKSON, HOWELL EDMUNDS, an American jurist; born at Paris, Tennessee, April 8, 1832. He graduated from the West Tennessee College, at Jackson, in 1849. In 1850 he entered the University of Virginia, and completed the course there. He began the practice of law at Jackson, and in 1858 removed to Memphis. When the Civil War broke out he was appointed receiver, under the Confederate Sequestration Act, for West Tennessee. At the conclusion of hostilities he returned to Memphis and resumed the practice of his profession. In 1880 he was elected to the Tennessee legislature, and was elected United States Senator by that body in 1881. On April 12, 1886, he was nominated by President Cleveland as circuit judge of the United States for the Sixth Judicial Circuit. In February, 1893, he was appointed associate justice of the United States supreme court by President Harrison, to succeed Justice Lamar. In politics Judge Jackson was a Democrat. He died Aug. 8, 1895, in West Meade, Tennessee.

JACKSON, JAMES, an American soldier; born at Moreton Hampstead, Devonshire, England, Sept. 21, 1757, and emigrated to America in 1772. He studied law in Savannah, Georgia, and in 1776 was active in repelling the British from that city. He afterward took part in many important battles and attained the rank of brigadier-general. In 1788 he was chosen governor of Georgia, but declined to serve, and from 1789 to 1791 was a member of the First Congress. From 1793 to 1795 he was United States Senator from Georgia, from 1798 to 1801 governor of the state, and from 1801 to his death was again Senator. Hedied in Washington, District of Columbia, March 16, 1806.

JACKSON, JOHN, an English portrait-painter; born at Lastingham, Yorkshire, in 1778. He removed to London in 1797 and was enabled to study at the Royal Academy. He was successful from the first, and in 1817 was elected a member of the Royal Academy. He left many portraits of eminent men, among them Canova, Flaxman, Chantrey and Sir Robert Peel. He died in 1831.

JACKSON, JOHN ADAMS, an American sculptor; born at Bath, Maine, Nov. 5, 1825. After studying in Boston, Paris and New York, he settled in Florence, where he produced numerous popular works, among which are *Eve and the Dead Abel*; *The Culprit Fay*; and *Dawn*. He also designed a number of groups and monuments for American cities. He died at Prachia, Tuscany, Aug. 30, 1879.

JACKSON, MERCY BISBEE, an American physician; born at Hardwick, Massachusetts, Sept. 17, 1802; practiced medicine at Plymouth, Massachusetts, and Boston, and in 1860 graduated from the New England Female Medical College. She was the first woman admitted to the American Institute of Homœopathy. She became professor of the diseases of children, in the Boston University School of Medicine, in 1873. She died in Boston, Dec. 13, 1877.

JACKSON, SAMUEL MACAULAY, an American clergyman; born in New York City, June 19, 1851; studied at the College of the City of New York, at Union Theological Seminary and at Leipsic; became Presbyterian pastor at Norwood, New Jersey (1876); was assistant editor of Schaff's *Bible Dictionary* (1878-80); joint editor with Dr. Schaff of the *Encyclopadia of Living Divines* (1886); editor of *The Magazine of Christian Literature* (1889-91.) He wrote several volumes of Dr. Schaff's *Church History*, and published in 1891 *A Concise Dictionary of Religious Knowledge*.

JACKSON, SHELDON, an American missionary; born at Minaville, New York, May 18, 1834; educated at Union College and Princeton Theological Seminary. He engaged in missionary work in 1859 in Wisconsin and Minnesota, later in Nebraska and Dakota, and in 1870 superintendent of missions west of Denver, Colorado. He was in New York City from 1882 until 1885 on the business staff of the *Presbyterian Home Missionary*. In 1885 he was sent by the United States Interior Department as general education agent in Alaska. Under his supervision schools have been established and an extensive system inaugurated. His biennial report to the Commissioner of Education is published by the Commissioner in the latter's report to the Secretary of the Interior. Among his published writings are *Alaska and Missions on the North Pacific Coast* (1880); and *Education in Alaska* (1881).

JACKSONVILLE, a town and the capital of Calhoun County, northeastern central Alabama, on the East and West and the Southern railroads, 13 miles N. of Anniston. It is the trade center of a cotton, corn, wheat and general-produce raising region, in which iron, marble and limestone are found in abundance. Coal, iron, lumber and cotton are extensively shipped. It contains a young men's college and ladies' seminary and a state normal school. Its mild climate makes it frequented as a summer resort. Population 1890, 1,237; 1900, 1,176.

JACKSONVILLE, a city of northeastern Florida and the capital of Duval County. Jacksonville has several churches and banks, a high-school, the Stanton Institute and manufactories of lumber, marmalade, moss, soap and machinery. Lumber is the chief article of export. Population 1860, 2,118; 1870, 6,912; 1880, 7,650; 1890, 17,201; 1900, 28,429. See also JACKSONVILLE, Vol. XIII, p. 536.

JACKSONVILLE, a city and the capital of Morgan County, western central Illinois, situated 34 miles W. by S. of Springfield, on the Chicago and Alton, the Jacksonville, Louisville and St. Louis and the Wabash railroads. Jacksonville contains many handsome buildings, and is noted for its educational and charitable institutions. It is the seat of Illinois College, a high-school, a ladies' athênæum, the Illinois Female (Methodist) College, the Jacksonville Female College, a musical conservatory, a public library, a state asylum for the insane, an asylum for the idiotic, an institute for the education of the blind, and an institute for the deaf and dumb. The institutions for the blind and the deaf and dumb are supported by the state. Illinois College is a non-

sectarian institution, founded in 1829, having 15 instructors, 214 pupils and a library of 15,000 volumes. The city has a large woolen-mill, flour-mills, machine-shops, a carriage factory, and soap, ice and brick and tile factories, car-works, water-works, a foundry, and manufactories of candy, paper, furnishing-goods, boilers, etc. Population 1880, 10,927; 1890, 12,935; 1900, 15,078.

JACKSONVILLE, a village and the capital of Jackson County, southwestern Oregon, on the Rogue River Valley railroad, which connects with the Southern Pacific. It has a Roman Catholic academy for girls, and is occupied in agricultural and gold-mining pursuits. Population 1900, 653.

JACME, JAYME or PEDRO, same as JAMES, two kings of Aragon. See SPAIN, Vol. XXII, pp. 322, 323.

JACOB-EAN LILY (*Spreckelia formosissima*), a plant of the family *Amaryllidaceæ*. The leaves are directly from the bulb, which is long-necked, protruding above the surface of the ground; the flowers are large, irregular, and of a brilliant crimson color. It is native in Mexico, and extensively cultivated.

JACOBI, ABRAHAM, an American physician; born at Hartum, Germany, 1830. After studying at the Universities of Greifswald, Göttingen and Bonn, at the latter of which he received his medical degree, he settled in New York City. In 1861 he was made professor of diseases of children in the New York Medical College; from 1867 to 1870, held a similar chair in the medical department of the University of the City of New York, and in the latter year in the College of Physicians and Surgeons. He held important offices in various scientific societies; wrote many valuable works on medical topics, among them *Infant Hygiene* (1872-74); *Treatise on Diphtheria* (1880); *Therapeutics of Infancy and Childhood* (1892).

JACOBI, HERMANN GEORG JAKOB, a German Sanskrit scholar; born at Cologne, Feb. 11, 1850; studied at Bonn and Berlin, where he made a specialty of Sanskrit; spent a year working on the Sanskrit manuscripts of the India office in London, and in 1873 went to India with Dr. Bühler, whom he accompanied on his tour through the Rajputana. One of his chief works was the computation of tables for the verification of Hindu dates. He made a careful study of Jainism and Prâkrit, the language in which the sacred books of the Jainas are written. In 1885 he became Professor of Sanskrit at the University of Kiel, and in 1889 accepted the Sanskrit professorship at Bonn.

JACOBI, MARY PUTNAM, an American physician; daughter of G. P. Putnam of New York; born in London, England, Aug. 31, 1842. She studied medicine in Philadelphia, New York and Paris, being the first woman admitted to the École de Médecine. In 1873 she was married to Dr. Abraham Jacobi. For twelve years she was dispensary physician in Mount Sinai hospital, was professor of materia medica in the woman's medical college of the New York infirmary, and later became professor in the New York post-graduate medical school. She contributed much to medical literature. Among her published writings are *The Value of Life*

(1879) and *Essays on Hysteria, Brain Tumor, etc.* (1888).

JACOBIN. See DOVE, Vol. VII, p. 379.

JACOBINS. See FRANCE, Vol. IX, pp. 596, 600-607.

JACOB OF EDESSA. See SYRIAC LITERATURE, Vol. XXII, pp. 839, 840.

JACOB OF HUNGARY, called THE MASTER; a French religious fanatic who played an important part in French history during the seventh crusade. Upon hearing of the surrender of St. Louis in Egypt, the "Master of Hungary" commenced preaching throughout the provinces of France a crusade for the liberation of the king. He soon gathered about him in Flanders some 30,000 peasants and shepherds called *pastourels*, and at their head started for Paris. The mob obtained arms and recruits at Amiens, and had increased to 100,000 when it arrived before Paris. As soon as the mob got within the walls of the city it began to commit depredations and to murder the monks, while Jacob himself assumed priestly functions. He divided his followers into several bands, and sent them by different routes toward the Holy Land. At Orleans they massacred the monks, and at Bourges the Jews. Owing to these excesses, Jacob was killed by the Queen's orders; and his followers, left thus without a leader, were dispersed quickly.

JACOB OF VITRY, a French preacher of crusades, and a historian; born at Argentine, in the second half of the twelfth century; was a zealous apostle of Maria of Oignies; and, led by his enthusiasm, he undertook to preach a crusade against the Albigenses, but finally devoted himself to the interest of the Holy Sepulchre. In 1217 he was appointed, by Pope Honorius III, Bishop of Acre, where he brought about great conversions of Saracen children. Pope Gregory IX, in 1229, appointed him Cardinal Bishop of Tusculum, and papal legate of France, Brabant and the Holy Land. He was considered one of the most fluent preachers of his time, but he is best known as the writer of *Historia Orientalis* or *History of Jerusalem*. He died at Rome, in 1240.

JACOBS, HENRY EYSTER, an American educator and writer; born at Gettysburg, Pennsylvania, Nov. 10, 1844; educated at Pennsylvania College and Gettysburg Theological Seminary; was three years tutor in Pennsylvania College, and in 1870 was called to the chair of Latin at Gettysburg, from which he was transferred ten years later to the chair of Greek in the same institution. In 1883 he became professor of systematic theology in the Theological Seminary at Philadelphia. Among his writings are a translation of Hutter's *Compendium of Lutheran Theology* (1867); Schmidt's *Doctrinal Theology of the Evangelical Lutheran Church* (1875); and *Commentary on the Revelation of St. John* (1887).

JACOBS, JOSEPH, an English critic and editor; born in 1854; studied at Sydney University and later at St. John's College, Cambridge. He was philosophical critic of *The Athenæum* from 1878 to 1888, and contributed to it the necrologies of George Eliot, Browning Newman and Matthew Arnold. He also wrote necrologies of Tennyson and Renan in *The Academy*. He became editor of *Folk-lore*, and

chairman of the literary committee of the International Folk-lore Congress.

JACOBS, PAUL EMIL, a German painter; born at Gotha, about 1800; studied at Munich, and later at Rome. He painted portraits with success, but his chief fame rests on his treatment of religious subjects, his best-known production in this line being the *Resurrection of Lazarus*. He traveled much in Greece and Italy, and did considerable historical painting. He exhibited widely in both Europe and America. He died Jan. 6, 1866.

JACOBSEN, JENS PETER, a Danish novelist; born in Denmark, April 7, 1847. He early devoted himself to scientific studies, and made a translation of Darwin. He published his first novel, *Mogens*, in 1872. It is the first specimen of realistic fiction in Danish literature, and shows the influence of Brandes. Among his later works are *Niels Lyhne* (1880); and *Mogens og Andre Fortaellinger* (*Mogens, and other Tales*) (1882). Jacobsen's influence on modern Danish fiction is considered greater than that of any other writer except Georg M. C. Brandes. He died April 30, 1885.

JACOBSON, WILLIAM, an English bishop; born in Norfolk, July 18, 1803; graduated at Lincoln College, Oxford, in 1827; was vice-principal of Magdalen Hall from 1832 to 1848; and later regius professor of divinity. In 1865 he was appointed Bishop of Chester. He was one of the most eminent scholars of his day, and while at Oxford edited for the University Press a large number of works, among them *Remains of the Apostolic Fathers* (1838); Nowell's *Catechism* (1844); and the *Collected Works of Bishop Sanderson* (1854). He died July 13, 1884, in Chester.

JACOBSON'S ORGAN. See SMELL, Vol. XXII, p. 166.

JACOBUS DE VORAGINE. See VORAGINE, Vol. XXIV, pp. 296, 297.

JACOBY, LUDWIG SIGISMUND, a German theologian; born at Alt-Strelitz, Oct. 21, 1811, of Jewish parents. He was converted to Christianity and joined the Lutheran church. In 1839, after pursuing a medical course, he emigrated to the United States and settled as a physician in Cincinnati. In 1841 he joined the Methodist Episcopal Church, in which he became a preacher, and in 1849 returned to Germany, to introduce Methodism into that country. His efforts resulted in the establishment of many missions, together with a publishing-house and theological seminary. Mr. Jacoby returned to the United States in 1871, and died in St. Louis, June 21, 1874.

JACOPO DEI BARBARI. See DÜRER, Vol. VII, p. 555.

JACOPONE, JACOMO BENEDETTI. See ITALY, Vol. XIII, p. 500.

JACQUARD LOOM. See WEAVING, Vol. XXIV, p. 465.

JACQUELINE, Princess of Bavaria. See HOLLAND, Vol. XII, pp. 72, 73.

JACQUEMART, JULES FERDINAND, a French artist; born in Paris, 1837. A son of Albert Jacquemart, a writer on the subject of porcelain and ceramics. His best work was in etching, and many of

his most worthy productions were executed for the illustration of his father's writings. His most remarkable work is a series of large etchings of the beautiful agate, jasper, crystal and porphyry vases, the ancient goldsmith work and fine enamels in the Louvre, the *gemmes et joyaux de la Couronne*. He died at Nice, Sept. 28, 1880.

JACQUEMONT, VICTOR, a French traveler and naturalist; born in Paris, Aug. 8, 1801. He made a study of botany, and visited the United States and the West Indies, whence he returned to Paris with a fine collection of plants. Under the appointment of the Museum of Natural History, he led an expedition through Hindustan and Tibet. He wrote a *Geological Treatise on the Alps and Travels Through India from 1828 to 1832*. He died prematurely at Bombay, Dec. 7, 1832.

JACQUERIE, the name given to an insurrection of peasants in France in 1358, when the French king, John, was a prisoner in England. The nobles called the peasants contemptuously "Jacques Bonhomme"; hence the word *Jacquerie*. The rising was caused by long-continued oppression on the part of the nobles. It broke out in the neighborhood of Paris, but extended to the banks of the Marne and Oise. The magnitude of the danger forced the nobles to make common cause, and on June 9th the peasants were defeated near Méaux. This put an end to the insurrection.

JAEGER-GULL, a name given to the skuas or gulls of the family *Stercorariidae*. They are large birds which pursue smaller gulls and rob them of their prey. Their habits are more like a hawk than a gull. Sometimes they capture and devour small birds. One species is antarctic and the others northern. Locally they are sometimes called gull-catchers.

JAGANNATH OR JUGGERNAUT. See ORISSA, Vol. XVII, p. 845.

JAGELLONS OR JAGIELLOS, DYNASTY OF. See POLAND, Vol. XIX, pp. 288-291.

JAGERNDORF OR KARNOW, a walled town of the province of Silesia, central northern Austria, on the border of the county, 17 miles by rail, N.W. of Trappau. It has manufactories of woollen cloth, linen and organs, and is the center of the woollen industry in Austria. Population, 14,278.

JAGGERY OR PALM-SUGAR. See SUGAR, Vol. XXII, p. 628.

JAGIC, VATROSLAV. See SERBIA, Vol. XXI, p. 691.

JAGO, JAMES, an English physician and writer on medical subjects; born Dec. 18, 1815, near Falmouth, Cornwall. He was educated at Cambridge University, and studied also at London, Dublin and Paris. In 1870 he was admitted a fellow of the Royal Society. In 1853 he published his treatise on the *Opening of the Eustachian Tube*, then first rightly explained. On attaining the seventieth anniversary of his birthday, Dr. Jago retired from the practice of his profession.

JAHN, FRIEDRICH LUDWIG, a German educator; known as "Turnvater Jahn," born at Lanz, Prussia, Aug. 11, 1778. He studied theology at Halle and Göttingen, and in 1805 went to Jena to continue

his studies, but soon afterward decided to enlist in the Prussian army. In 1809 he went to Berlin, and in the following year became a teacher in a gymnasium and published his *Das Deutsche Volksthum*. In 1811 he opened the first *turn* establishment in Berlin, and rendered the science of gymnastics so popular that it soon attracted the attention of the youth throughout the kingdom. It at once formed centers around which German patriotism gathered and developed, and its influence on the whole system of education was lasting and beneficial. In 1814 Jahn was placed in command of a volunteer corps, served in the subsequent campaigns, and entered Paris in 1815. After the war, however, he opposed the reactionary policy of the government, the *turn* places became nurseries of liberal thought, and in 1818 he was seized by the Prussian government and imprisoned. He was liberated in 1825, but was not allowed to reside in any university town. He settled at Freiburg, where he wrote *Neue Runenblätter* in 1828, and *Merke Zum Deutschen Volksthum* in 1833. In 1848 he was elected to the national assembly, but took no prominent part in its deliberations. The Jahn Stiftung was founded in his honor at Leipsic, in 1863, and a statue of Jahn was erected in the Hasenheide, near Berlin, in 1872. He died at Freiburg, Oct. 15, 1852.

JAIL FEVER. See TYPHUS, Vol. XXIII, pp. 676, et seq.

JAIPUR. See JEYPORE, Vol. XIII, p. 688.

JAKUTSK. See YAKUTSK, Vol. XXIV, pp. 725-727.

JALALABAD. See AFGHANISTAN, Vol. I, p. 230.

JALISCO, State of Mexico. See MEXICO, Vol. XVI, pp. 214, 215, et seq.

JAMAICA, the largest island of the British West Indies. Total population 1892, 649,524; capital, Kingston, with 48,500 population; Spanish Town (old capital), now second city. The government includes a governor and a legislative council of 16 members (nine elected, five official and two nominated by the crown). See also JAMAICA, Vol. XIII, pp. 548-558.

JAMAICA, a village, and the capital of Queens County, on southern Long Island, 10 miles E. of New York City, on the Long Island railroad. It is in a truck-gardening region, and has manufactories of wagons and carriages. It has Union Hall Academy, a public library, and has received an appropriation of \$100,000 for a normal school from the state legislature. It is a residence village for New York business men. Pop. 1900, included in Greater New York.

JAMES, EDMUND JANES, an American political economist and educator; born at Jacksonville, Illinois, May 21, 1855; educated at Northwestern University, Harvard University and the Universities of Halle, Leipsic and Berlin. He was principal for some time of the high-school at Evanston, Illinois, and later, of the Illinois State Normal School, Normal, Illinois. In 1883 he became professor of public finance and administration in the Wharton School of Finance and Economy, University of Pennsylvania. In 1892, under commission from the American Bankers' Association, he visited Europe for the

purpose of studying the business methods of other countries. In 1896 he was called to Chicago University as professor of public finance. He published a number of articles on economic subjects, besides numerous papers and addresses on university extension. Among his writings are contributions to Lalor's *Cyclopadia of Political Economy*; *Chairs of Pedagogics in Our Universities* (1887); *Our Legal-Tender Decisions* (1888); and *The Education of Business Men* (1890).

JAMES, HENRY, an American theologian; born in Albany, New York, June 3, 1811. He studied theology both in America and abroad, and became a follower of the tenets of the Sandemanian sect, and later, of the Swedenborgian. For many years he resided in New York City, and for some time in Newport, Rhode Island, but in 1866 went to Cambridge, Massachusetts, where he remained until his death. He was a constant contributor to periodical literature. Among his writings are *Moralism and Christianity* (1852); *Substance and Shadow* (1863); and the *Secret of Swedenborg* (1869). He died at Cambridge, Massachusetts, Dec. 18, 1882.

JAMES, HENRY, JR., an American novelist and essayist, and leading representative of the analytical school of modern fiction;

born in New York, April 15, 1843. His father was the late Rev. Henry James, a well-known philosophical writer, who died in 1882. In 1854, the James family went abroad, and resided for about six years in England, France and Switzerland. On returning to the United States the family took up its residence first at Newport, Rhode Island, and afterward at Cambridge, Massachusetts, where Henry James the younger began the study of law. Being delicate in health (the reason why he never took a university course), and possessed of a modest competence, he again went abroad, living alternately in France, Italy and England, with occasional visits to the United States. In 1870 he seriously began his literary career by contributing a story to the *Atlantic Monthly*, followed by two novels, *Watch and Ward* (1871), and *Roderick Hudson* (1875). His European life led him to steep himself in the subtleties of the French and Russian contemporary school of novelists, an influence which has not only thoroughly un-Americanized him, but has imparted to not a few of his character-creations an air of the fanciful and ideal. On the other hand, it has made him essentially cosmopolitan and able to treat national characteristics and types from a neutral standpoint, particularly in those stories, such as *The American* (1878), and *The Europeans* (1878), which may be said to represent the "international novel." He thus became, to some extent, an innovator in literature, the more so as his stories are for the most part without plot, and concern themselves mainly with the mental development of human character.



HENRY JAMES, JR.

His fine culture and delicate wit make him a favorite with people of intellectual tastes, though his want of vigor and his philosophic refinements are an occasional weariness to the general reader. As a critic he has been awarded high praise for his literary and biographical studies, such as *Partial Portraits* (1888); *French Poets and Novelists*, with an essay on Turgenief (1878); and his monograph on *Nathaniel Hawthorne* in the English Men of Letters series. His more important novels, besides those already mentioned, are *Confidence* (1878); *Daisy Miller: a Comedy* (1878); *Diary of a Man of Fifty* and *A Bundle of Letters* (1879); *Washington Square* (1880); *The Portrait of a Lady* (1881); *The Bostonians* (1886); *Princess Casamassima* (1886); *The Tragic Muse* (1890); *Watch and Ward* (1890); *Terminations* (1891); and *The Wheel of Time* (1892). Besides these, Mr. James has published many collections of stories and a few books of travel and miscellaneous pen-sketches, the chief of which are *Trans-Atlantic Sketches* (1875); *Theatricals*, 1st and 2nd series (1879-81); *Portraits of Places* (1884); *A Little Tour in France* (1884); *The Reverberator* (1888); *The Aspern Papers* (1888); *A London Life* (1889); *The Siege of London*, including *The Pension Beaurepas* (1893); *Picture and Text* (1893); *Lesson of the Master, and Other Stories* (1892); *The Wheel of Time* (1892); *The Real Thing* (1892); *The Private Life* (1893); *What Maysie Knew* (1897); *The Two Magics* (1898); *In the Cage* (1898); and *Essays in London*, with a sketch of *Pierre Loti*, papers from the *Century* and the *Fortnightly Review*. Mr. James also produced in London, in 1891, a play founded on his novel, *The Americans*; also a drama, *Guy Domville*, with an eighteenth-century hero.

JAMES, SIR HENRY, an English engineer and inventor; born at Rose-in-Vale, near St. Agnes, Cornwall, in 1803. He was educated at the Royal Military Academy, Woolwich, and in 1825 passed into the Royal Engineers. In 1844 he was appointed director of the Geological Survey of Ireland; in 1846, head of the Admiralty Works at Portsmouth; in 1852, director of the ordnance survey of the United Kingdom; and in 1857, chief of the Statistical and Topographical Department of the War Office. He was knighted in 1860, made major-general in 1868, and lieutenant-general in 1874. He is best known for his successful efforts to introduce applications of photography into the service of the exact sciences. By means of photozincography, a process which he invented in 1859, he produced fac-similes of *Domesday Book*, and of national manuscripts of England, of Scotland and of Ireland. He is the author of several works on geology, surveying, etc. Among these are *Photozincography* (1860); and *Plans and Photographs of Stonehenge and Eurusachan* (1867). He died at Southampton, June 15, 1877.

JAMES, THOMAS LEMUEL, an American publicist; born at Utica, New York, March 29, 1831; was a pupil at the Utica Academy until he was 15 years of age. Upon the formation of the Republican Party Mr. James entered the new organization, and during the Frémont canvass for the presidency became proprietor and editor of the *Madison County Jour-*

*nal*, which he retained for ten years. Upon the inauguration of President Lincoln in 1861 he was appointed inspector of customs. In 1874 he was made weigher, and in 1876 deputy collector of customs, in 1877 postmaster at New York City. He removed the office entirely "out of politics," making merit the only test for appointments and promotions, largely increased its revenues, introduced many mechanical improvements, and in other ways added greatly to its usefulness. President Garfield appointed him Postmaster-General in March, 1881. In Jan., 1882, he retired from political life to the presidency of the Lincoln National Bank in New York city.



THOMAS L. JAMES.

JAMES, WILLIAM, an American psychologist; born in New York city, Jan. 11, 1842; educated in the schools of New York, at Harvard, and in Europe. In 1872 he became professor of anatomy and physiology at Harvard, later of philosophy, and finally of psychology. Besides magazine articles, he has written *Principles of Psychology* (1890); *Psychology, Briefer Course* (1892); and *Human Immortality* (1898).

JAMES BAY, an arm of Hudson Bay, extending from the southeastern part southward. It extends from lat. 51° to 55° N. and from long. 79° to 82° 30' W. It contains many islands, and receives the Big, East Main, Abbitibi, Mosse, Albany, Attahwahpsiskat, Equan and other rivers. Its name is derived from Captain Thomas James, who wintered here in 1631, while attempting to find the northwest passage.

JAMES ISLAND, one of the Galapagos Islands, near lat. 0°, long. 90° W. It is formed of volcanic basalt, and, except in small portions, is arid. It belongs to Ecuador.

JAMES OF HEREFORD, LORD, better known under his earlier title of Sir Henry James; a British lawyer and statesman; born at Hereford, England, Oct. 30, 1828; received his education at Cheltenham College and was called to the bar of the Middle Temple in 1852. In 1850, as again in 1851, he attained legal distinction as lecturer's prizeman at the Inner Temple. He became a Queen's counsel in 1869, a bencher of his Inn in 1870, and in 1869 entered the House of Commons for Taunton, which he continued to represent in the Liberal interest until 1885. In 1873 he was appointed Solicitor-General, and was Attorney-General in 1873-74, and again from 1880 to 1885. During the latter period he introduced and carried through Parliament the Corrupt Practices Act. Returned for Bury in 1885, he refused to follow Mr. Gladstone upon the Home Rule question, although offered the Lord Chancellorship, and was afterward one of the active leaders of the Liberal Unionist party. Sir Henry defended the case for the *Times* before the commission appointed to investigate the charge against Mr. Par-

nell and the Irish members. In 1892 he was again returned for Bury and took a leading part in the discussion of the Home Rule Bill in 1893. He was created a peer in 1895.

**JAMESON, JOHN ALEXANDER**, an American jurist; born in Irasburg, Vermont, Jan. 25, 1824. He was tutor at the University of Vermont, where he graduated in 1846, from 1850 to 1853, and then began the practice of law in Freeport, Illinois, where he remained three years. In 1856 he removed to Chicago, and from 1865 to 1883 was judge of the superior court of that city. He wrote *The Constitutional Convention: Its History, Powers and Modes of Proceeding* (1867). He died in 1891.

**JAMESON, LEANDER STARR**, an English colonial administrator of Mashona and Matabeleland, whose firebrand dash into the territory of the South African Republic embroiled England with Germany and the Boers. He was born in Edinburgh, Scotland, in 1853; was educated in University College Hospital, and at the London University, where he graduated with honor in 1875. He traveled in America for his health, and then went to South



LEANDER S. JAMESON.

Africa. In 1878 he settled at Kimberley, and soon acquired a lucrative medical practice. Daring to a degree, he went into the heart of Matabeleland to treat Lobengula, its king, and numbered President Kruger among his patients.

In 1888, having become associated with Cecil J. Rhodes (q.v., in these Supplements), he proceeded on a mission to Lobengula, and again in 1890, when the South Africa Chartered Company had commenced operations. Soon afterward he settled at Fort Salisbury, in Mashonaland, as the representative of C. J. Rhodes, and while there successfully conducted a surveying expedition into Mashonaland and a commission to a neighboring savage king. In 1891 he became administrator of the South Africa Company's territory, and was at the head of the Matabele campaign which resulted in the acquisition of much territory by the South Africa Chartered Company.

Jameson was involved in the raid which resulted from the Uitlander agitation in Johannesburg, and on Dec. 29, 1895, started from Pitsani Potlugo with a large force of South African police, having first cut the telegraph wires, and with the intention of proceeding to Johannesburg. On January 1st, after having been ordered on his allegiance, to return, he was opposed, by a force of Boers at Doornkop, and his advance toward Johannesburg checked. Next day he surrendered to the Boer commandant at Krugersdorp.

He was taken to England and arraigned with his officers on March 10, 1896, and was subsequently convicted and sentenced to 15 months'

imprisonment as a first-class misdemeanant, on July 28th of the same year.

Personally, he was a man of indomitable courage, who had done much for the colonists of South Africa. While apparently the tool of designing men—for it was questionable whether the entire agitation had any other end than the commercial aggrandizement of its principal promoters—Jameson's hasty action is said to have been in defiance of positive orders from the reformers in Johannesburg, who were not sufficiently prepared with arms and ammunition to assist his advance. Sir R. E. R. Martin was appointed administrator of police in his place in 1896.

**JAMES RIVER** is formed by the union of the Jackson and Cowpasture streams in Allegheny County, central western Virginia, and has its entire course in that state. It flows in a generally east-southeast direction, passing Lynchburg and Richmond, and, widening into an estuary for the last sixty miles of its course, it falls into Chesapeake Bay at its southern extremity. It is 450 miles in length, and is navigable for large steamers to City Point, at the mouth of the Appomattox. The James River and Kanawha canal, a part of the proposed route between the Mississippi Valley and the Atlantic, which extends from Richmond to the White Sulphur Springs, follows the windings of the river for a considerable distance.

**JAMESTOWN**, a city of Chautauqua County, western New York, on the navigable outlet of Chautauqua Lake and on the Chautauqua Lake railroad and the New York, Lake Erie and Western railroad. It contains several churches, national banks and hotels, and also has a union school, the Jamestown Collegiate Institute, a piano factory, a woolen-mill, a large manufactory of alpaca, and manufactories of tools, furniture, worsted goods, plush goods, boilers and engines and boots and shoes. It has electric and natural gas lights, Holly water-works and electric street-railways. Pop. 1890, 16,038; 1900, 22,892.

**JAMESTOWN**, a city and the capital of Stutsman County, southeastern central North Dakota, on the James River and the Northern Pacific railroad, 90 miles W. of Fargo. It is the third city in the state, and contains the state insane asylum. It is in a grain, stock and vegetable producing section. Population 1900, 2,853.

**JAMESTOWN**, a ruined village of James City County, Virginia, where in 1607 the first permanent English settlement was made in America. The place was burned by Bacon in 1676, and never rebuilt. Its site is about lat. 76° 48' N., long. 76° 48' W. In consequence of fluctuations in the channel of the James River, the old site is practically under water now.

**JAMNA**. See **JUMNA**, Vol. XIII, p. 773.

**JAMNOTRI** OR **JUMNOTRI**, hot springs in the northwest provinces of India, near the source of the Jumna or Jamuna, 10,849 feet above the sea, in lat. 30° 59' N. and long. 78° 35' E. Their temperature is 104° 7' F. (a little higher than blood heat) at their elevation. They are over-



hung by three connected mountains known as the Jumnotri Peaks, 25,500 feet high.

JANAUSCHEK, FRANCESCA ROMANA MAGDALENA, a Bohemian actress; born at Prague, July 20, 1830; appeared first at Cologne in tragic rôles, and later at Dresden, Frankfort and the principal theaters of Germany. On her first visit to the United States, in 1867, she achieved great success, though performing in German only. Returning to Germany, she devoted herself to the study of English, and returning to the United States in 1873, successfully represented in English the most difficult rôles of Shakespearian tragedy. In 1884 she visited Australia, and in 1896 made her third visit to the United States, appearing in *The Diamond Robbery*. Her leading impersonations are those of Medea, Lady Macbeth and Marie Stuart.

JANES, EDMUND STOREY, an American Methodist Episcopal bishop; born at Sheffield, Massachusetts, April 27, 1807; after receiving a common-school education he taught school for a time, after which he studied law, but gave up the profession for that of the ministry. In 1830 he was admitted to the Philadelphia conference, and from 1840 to 1844 was financial secretary of the American Bible Society. In the latter year he was elected and ordained bishop, and in 1854 he visited Europe as a delegate to the British Wesleyan conference. From his election to the episcopacy until his death he resided in New York City. He died Sept. 18, 1876.

JANESVILLE, a city and the capital of Rock County, central southern Wisconsin, situated on both sides of Rock River, 70 miles W.S.W. of Milwaukee, on the Chicago, Milwaukee and St. Paul and the Chicago and Northwestern railroads. It contains a court-house, several churches and banks, a high-school, a state institution for the education of the blind, several musical schools, a public library, a cotton factory, woolen factories, flouring-mills, machine-shops, foundries, manufacturing of farming implements, carriages, boots and shoes, and it has blooded-horse breeding farms. Population 1880, 9,018; 1890, 10,836; 1900, 13,185.

JANET, PAUL, a French author; born in Paris, April 30, 1823; and educated at the École Normale, graduating in 1848. He was in turn teacher in the gymnasium at Bourges, and professor of philosophy in the faculty at Strasburg, and of logic in the Lyceum Louis-le-Grand. In 1864 he was elected to the Academy of Moral and Political Sciences, and afterward lectured in the Sorbonne, at Paris. M. Janet is a leading representative of modern French philosophy. His best-known works are *Final Causes* (1876); *Theory of Morals* (1884).

JANISSARIES, a corps of Turkish foot-soldiers, organized in the first half of the fourteenth century, in the reign of the Sultan Orkhan. It was at first made up of men captured as children from Christian parents and brought up as Mussulmans. They were forbidden to marry, had no habitation but their quarters, but had many special privi-

leges, and were obliged to take the field only when the Sultan commanded in person. No more unnatural and formidable military organization ever existed. For more than two centuries the Ottoman victories were mainly due to their ferocity and courage. In time, however, the Janissaries became lawless and insubordinate; they put to death more than one sultan and deposed others, and became cowardly and treacherous in battle. When, in 1826, being called upon to contribute to the regiments for the approaching war with Russia, they revolted, Mahmoud II determined upon their destruction. They made desperate resistance, but 16,000 of them were killed in the streets, 7,000 were burned in their barracks and 25,000 were exiled, thus annihilating the corps.

JAN MAYER'S LAND. See NORWEGIAN SEA, Vol. XVII, pp. 592, 593.

JANNEY, SAMUEL MACPHERSON, an American preacher and author; born in Loudoun County, Virginia, Jan. 11, 1801. He was a minister of the Society of Friends, and traveled extensively in that capacity. In 1869 he was made United States Superintendent of Indian Affairs in the northern superintendency. Among his writings are *The Country Schoolhouse*, poem (1825); *Historical Sketch of the Christian Church* (1847); and *History of the Religious Society of Friends* (1867). He died in Loudoun County, Virginia, April 30, 1880.

JANS, ANNEKE, or more correctly, ANNETJE (JANSEN) BOGARDUS, a Dutch heiress in New Amsterdam (New York), the litigation over whose property was the *Jarndyce versus Jarndyce* of New York's courts. Born in Holland about 1600, in 1638 she married Eberhardus Bogardus, New Amsterdam's second minister. Her husband resigned under charges in 1647, and she sailed with him for Holland. The vessel was wrecked on the English coast, Sept. 27, 1647, Bogardus and 80 others being drowned. In 1654 his widow obtained a patent in her own name of a farm of 62 acres, comprising the most valuable part of the present city of New York. She died at Beverwyck, N. Y., March 19, 1663. The claimants to her estate have been plentiful to an extreme degree. After the title to the major portion of the property had been confirmed by the New York legislature to the Trinity Church Corporation, which had come into possession, pretended heirs arose to claim inheritance. In 1899 several societies of so-called Anneke Jans heirs were in existence, which, regardless of a first essential of civilized government—a statute of limitations—spent much hard-earned money annually in pursuit of an *ignis fatuus*, and enriched the unscrupulous persons who deluded them with false hopes. The subject of the Anneke Jans estate was dealt with in an article on *Unclaimed Estates*, by H. Sidney Everett, in *The Atlantic Monthly* of Feb., 1896.

JANSON, KRISTOFFER, a Norwegian clergyman; born in Bergen, Norway, May 5, 1841. While in Norway he was interested in the movement which had in view the replacing of the Danish language, which is the Norwegian language of

literature, by the truly Norwegian language, and wrote a large series of novels in this language. He also published a large number of poems and religious songs. In 1882 he removed to the United States and settled in Minneapolis, Minnesota, taking charge of the Unitarian parish in that city. Among his books translated into English are *The Spellbound Fiddler*; *The Children of Hell*. He died in Frankfort-on-the-Main, Dec. 24, 1891.

JANSSEN, PIERRE JULES CÉSAR, a French astorian; born at Xanten, April 10, 1829; studied at Bonn, and became professor of history in the gymnasium at Frankfort-on-the-Main. He became widely known by his *Geschichte des Deutschen Volkes Seit dem Ausgang des Mittelalters* (1876-88), a history of the German people from the close of the middle ages to the beginning of the Thirty Years' War. His work has been accepted as the ultramontane answer to the Protestant attacks upon the Roman Church of the sixteenth century. He died in Frankfort-on-the-Main, Dec. 21, 1891.

JANSSEN, PIERRE JULES CÉSAR, a French astronomer; born in Paris, Feb. 22, 1824; served as professor in the Lycée Charlemagne, and in the Special School of Architecture. From 1857 to 1867 he visited Peru, Italy, and the Azores in charge of astronomical expeditions. He went to India in 1868 to observe the total eclipse of the sun, especially by making spectroscopic observations of the protuberances. He found that with his powerful spectroscope he could continue to follow the protuberances after the eclipse was over. In 1875 he was appointed director of a physical observatory at Mendon, near Paris. In 1892-93 he founded an observatory on the top of Mont Blanc.

JANVIER, THOMAS ALLIBONE, an American author and journalist; born in Philadelphia, Pennsylvania, July 16, 1849; he traveled extensively both in Spain and Mexico, making an exhaustive study of the history, geography, architecture and scenery of the latter country. His books, some of which were written over the pseudonym of "Ivory Black," were suggested largely by these travels. Some of his best-known works are *The Mexican Guide* (1889); *The Aztec Treasure-House* (1890); *Stories of Old and New Spain* (1891); *An Embassy to Provence* (1893); *In Old New York* (1894); and *The Women's Conquest of New York, by a Member of the Committee of Safety of 1908* (1894).

JAPAN. See JAPAN, Vol. XIII, pp. 569-95. The total area of Japan, according to the official returns of 1896, is 147,655 square miles, with a population of 42,708,264 (21,561,023 males, and 21,147,241 females). In 1895, Formosa and the Pescadores Islands were ceded to Japan by China. Formosa has an area of 13,541 square miles, and a population of about 1,996,989. The Pescadores have a population of about 44,820. On Dec. 31, 1897, the census gave a population of 43,228,863.

In 1896 the population was divided among the various classes as follows: Imperial family, 45; kwazoku, or nobles, 4,375; shizoku, or knights (formerly retainers of the daimios), 2,067,907; common

people, 40,635,892. The number of foreigners in 1896 was 9,238, of which 4,533 were Chinese, 1,960 English, 1,025 Americans, 476 Germans, 343 French. The number of Japanese residents abroad in 1896 was 54,342.

On Feb. 11, 1889, a constitution was promulgated, laid out on German lines, which, while jealously careful of the prerogatives of the throne, established two houses, whose approval is necessary for the passage of every law, debates being held in public.

Provincial assemblies were instituted in 1879, and have been growing in importance and efficiency. For administrative purposes Japan is divided into forty-three *ken* or prefectures and three *fu* or city governments (Tokio, Kioto, Osaka). The succession to the throne has been definitely fixed on the male line. The civil list amounts to 3,000,000 yen per year, a yen being equivalent to half a dollar.

DEFENSE. *Army*. The Emperor has the supreme command of the army and navy. According to the present law, all males of the age of twenty are liable to serve in the standing army for seven years, three in active service and four in the army of reserve. After quitting the army of reserve they have to form part of the *landwehr* for another five years, and every male from seventeen to forty years of age who is not in the line, the reserve or the *landwehr*, must belong to the *landsturm*, and is liable to be called to service in times of national emergency. Including miscellaneous services, the army strength on the peace footing in 1897 amounted to 3,261 officers, 89,945 non-commissioned officers and men, 2,400 students, 220 field-guns, 106 mountain-guns, and 29,000 horses. There are a staff college, military college, cadet college, military school, gunnery school, a school for non-commissioned officers, etc. The reserve has a strength of 83,080, and the *landwehr* of 104,954. All the firearms, ordnance, and ammunition used in the imperial army are manufactured at the arsenals of Tokyo and Osaka. The rifle now used in the army is the Murata rifle, which was invented in Japan about 1881.

*Navy*. Japan is divided into five naval districts, each with a commander-in-chief. In 1896 only three such offices had been actually established, viz.: at the naval port of Yokosuka in the first district, the naval port of Kure in the second, and the naval port of Sasebo in the third.

The naval strength of Japan in 1897 was as follows: 3 first-class battleships, and 3 in course of construction, 7 armored cruisers, 16 protected cruisers, 5 third-class; and 12 gun vessels. The torpedo flotilla consisted of 16 first-class, 23 second-class, and 28 third-class boats. There were 14 admirals, 613 officers, 134 engineers, 57 constructors, 136 surgeons, 140 commissariat officers, and 10,161 men. The *personnel*, trained as in the navies of Europe, gave excellent proofs of bravery, steadiness, and discipline during the war with China.

**MERCHANT MARINE.** In 1897 the merchant navy of Japan consisted of 735 vessels of European build, of 253,326 tons, and 668 native craft above 50 tons, of 51,152 tons.

Of the total foreign ships entered in 1897, 1,020 were British; 361, German; 76, American; 26, French; 85, Norwegian; 63, Russian; 9, Korean; 3, Dutch; 4, Chinese; 854, of other countries. Of the total shipping, 590 vessels of 827,937 tons entered Nagasaki; 358 of 422,150 tons, Yokohama; 350 of 457,223 tons, Kōbē.

All open ports and other important cities and towns are connected with each other, and with Europe, by lines of telegraph. In 1897 there were 11,720 miles of telegraph, besides 387 miles of submarine cable. The number of telegrams carried was 10,978,153 in the fiscal year 1896-97. There were 1,114 offices in Japan.

There were in 1897, 528 miles of telephone, with 6 exchange offices, 25 calling-offices, and 3,232 subscribers.

**PUBLIC FINANCES.** *Imperial.* The following are the revenue and expenditure for the fiscal year 1897-98: Revenue, \$238,709,484; expenditure, \$249,547,286.

The public debt of Japan stood as follows, March 31, 1897: Home debt, 7½ per cent, \$4,000,000; 5 per cent, \$378,615,020; no interest, \$27,486,363; total, \$410,101,383. Foreign debt, 7 per cent, \$233,752. Total debt, \$410,335,135. Paper currency, \$9,045,082.

*Local.* The estimated revenue of Fu and Ken for 1896-97 was \$21,298,049, and expenditure \$22,314,940. The treasury was to grant to local governments \$1,061,758.

**COMMERCE.** The value of the commerce of Japan for 1897 was: Imports, \$219,300,772; exports, \$163,135,077. The foreign commerce of Japan is carried on through the open ports of Yokohama, Kōbē, Nagasaki, Hakodate, and Niigata. The exports of bullion and specie in 1897 amounted to \$19,219,163, and imports to \$81,466,713.

**INTERNAL COMMUNICATION.** *Roads.* There were in 1894, 4,481 miles of state roads, and 15,362 miles of provincial roads.

*Railways.* Railways are of two classes: (1) State railways; (2) railways owned by private companies, twenty in number, four of them guaranteed a certain rate of interest by the government. In 1896-97 there were 631 miles of the former, which carried 1,276,658 tons of goods and 22,681,161 passengers; there were 1,873 miles of the latter, which carried 5,421,013 tons of goods and 42,426,737 passengers.

**POSTAL SYSTEM AND TELEGRAPHS.** During the fiscal year 1896-97 there passed through the mails 403,818,612 letters and postal-cards, 86,801,875 newspapers, and 6,617,114 books. The income of the post office for the year 1895-96 amounted to \$8,341,042, and the expenditure to \$5,433,825.

**MONEY AND CREDIT.** Since Oct., 1897, the standard of value has been gold. The unit is the gold yen, .900 fine, weighing 83 grammes, and con-

taining 75 grammes of pure gold. The ratio to silver is 32⅓ to 1. There is a state bank, the Nippon Ginko, whose paper notes, redeemable in silver, have largely taken the place of the former fiat currency. The currency, though no longer fiat, is still practically entirely of paper, except subsidiary silver coins of 50, 20, and 10 cents, 5-cent nickels, and 2, 1, and ½ cent copper coins.

**WEIGHTS AND MEASURES.** The English pound is largely used in the cities for the *kin* (= 1.325 pounds). The lineal foot = .994 English. In measures of capacity, 10 *go* = 1 *sho* = 108.5 cubic inches, a little more than 1½ quarts.

It is stated to be the policy of the government to introduce at an early period a new system of weights and measures, based on the metric system.

Mean solar time for 135° long., or 9 hours east of Greenwich, has been adopted.

As before intimated, the progress which has been made by the Japanese in the civilization of the West is very remarkable. Young men of exceptional promise have been sent to the great universities of Europe and America, to return, upon the completion of their education, and mingle with the people as a leavening factor of the most potent quality. The empress and her suite have recently adopted foreign costume, being followed, to a certain extent, by the fashionable ladies of the capital. Japan's expeditions to Formosa to punish piracy; her annexation in 1879 of the Loo Choo Islands, notwithstanding China's remonstrances and threats; her spirited policy in Corea in 1873, 1882, 1894 and 1895; her conscription law of 1883 and subsequent army reorganization; her development of a strong navy; her coast-defense scheme of 1887, subscribed to liberally by wealthy private individuals, sufficiently attest the nation's assertive spirit. While so hurried an assimilation of Western ideas as was made necessary owing to her complete previous isolation has undoubtedly been accompanied by numerous minor imprudences and extravagances, yet through it all the patriotic spirit of the nation has triumphed, and her administration may now (1896) be said to be in a highly satisfactory condition. During the past few years, especially since the promulgation of the popular constitution in 1889, the court has emerged entirely from its seclusion. By the new constitution, absolute freedom of religious belief and practice is secured, so long as it is not prejudicial to peace and order. Education is general and compulsory. There is a complete system of local elementary, middle and normal schools and a central university in the capital, with five higher middle schools as feeders. There is also a higher normal school at Tokio. Education is perfectly free from class restrictions. The printing-press is very active, and newspapers are comparatively dearer than in the United States. The Japanese police is a most efficient force. The convict system is an excellent one, and the establishments are so conducted as to be a source of revenue to the government. Penal and civil codes have been drafted on a European basis.

Taxation mostly falls upon the land and upon the wine, which is called saké.

The United States, perhaps, of all the nations of the earth, entertains for Japan the most sincere feelings of friendship. The way in which she has struggled to attain to the standard of Western civilization, so that she might acquire the coveted position of equal among the best, has constituted a strong and pathetic appeal to the democracy of America. From a feudal despotism she has become a constitutional government; she has produced a code of laws in harmony with that constitution. She is educating her judges and fitting them for the highest judicial functions. She grants by that constitution civil and religious liberty to all her subjects. There is a growing feeling in this country that the foreign treaties of the great powers with Japan should be revised, and that the judicial and tariff autonomy, which was taken from her in the days of her weakness and ignorance, should be restored.

In the spring of 1889 the combination of treaty powers was broken through by the action, first of the United States and then of Germany and Russia, who formed treaties on their own account, abolishing extra-territoriality and sanctioning mixed residence under certain mild restrictions. These treaties were to come into force in 1890. Mexico, not a treaty power, had also arranged an independent treaty in November, 1888. Other powers prepared to follow, but treaty revision was at length shelved by the Kuroda Cabinet.

On Oct. 28, 1891, one of the severest earthquakes ever known in Japan occurred. Without any previous warning, shocks were felt from Tokio to beyond Kobé, a distance of more than 375 miles.

The city of Nagoya, with a population of 165,000 and 40,000 houses, was almost totally destroyed. According to the police reports, it lost 2,007 in killed and 2,158 wounded, with a total destruction of 31,764 houses. Gifu, with a population of 28,000 and 7,000 houses, lost in killed more than 2,000 and about an equal number wounded, with the total destruction of more than one half of the city; of the remaining half, the streets were so badly littered with the débris caused from above and below, that it seemed as if the city could never be rebuilt. Ogaki, with a population of 20,000, lost in killed 1,000 (estimated) and in wounded about an equal number, with the almost complete destruction of the city; in fact, only four streets are said to remain, the others being completely upheaved and filled with wreckage. Great damage was done to the railway and telegraph lines, an iron bridge over the Nagaragawa River being demolished.

Near Lake Biwa, saline water was forced from the earth and rose to a height of several feet; but the flow soon ceased from these cracks. Immediately following the convulsion, the water in Owari Bay became greatly agitated, the waves rising to an unusual height and seeming to flow from all directions, causing the wreck of a great many junks and other vessels.

In July, 1894, Japan became embroiled in a fierce war with China. For the causes which led to this war, the battles on land and sea-fights of the conflict, and the results to China, Corea, and Japan, see COREA, in these Supplements.

JAPAN AFTER THE WAR. After the war was over the Japanese intended going ahead, and everything seemed to portend that they would carry out this intention successfully. For a considerable time past there has been exceptional activity in the direction of improvements in the system and methods hitherto existing in commerce, industries, and agriculture. High government officials, members of the diet, and private individuals of standing and experience have been constantly lecturing on a vast diversity of subjects, with the object of stimulating the energies of all concerned. All sorts of guilds and associations have been formed to promote the material welfare of the nation, and commissioners have been sent all over the Empire, as well as to foreign countries, in the interest of more extended commercial business. The expansion of direct trade appears to be what influential men seek to bring about; they hold that, although there have been some failures, the successful manner in which others have been carrying on direct transactions is a good proof of the possibility of dispensing with outside aid.

In recent years, Japan has continued to develop on Western lines and to adopt Western ideas. In July, 1899, foreign jurisdiction in the treaty ports was abolished and the whole Empire was thrown open to American and European trade. Foreign residents are henceforth to have the same privileges and advantages as natives. Christianity is henceforth also to have the same protection as the native religions. Of late, however, there would seem to be a reaction in favor of the native creeds. Education has become compulsory. Trouble continues to be expected with Russia in regard to Corea. The attitude of Japan towards the American and European Powers in regard to the Boxer disturbances in China has been most friendly and helpful.

JAPAN CLOVER, the common name of *Lespedeza striata*, one of the *Leguminosæ*, introduced into the southern United States from eastern Asia. It is especially prevalent in the Southwestern states. Desert soils present no obstacle to its spread, and it is of great value for grazing purposes. It is low and spreading, diffusely branched, with oblong or wedge-shaped leaflets, and one to three small purplish flowers in the axils.

JAPANESE LANGUAGE AND LITERATURE. See JAPAN, Vol. XIII, pp. 585-588.

JAPP, FRANCIS ROBERT, a Scotch scientist and author; born at Dundee in 1848; educated at the Universities of St. Andrew's, Heidelberg and Bonn. His various researches, which deal exclusively with questions relating to organic chemistry, have been published chiefly in the *Journal of the Chemical Society*. Professor Japp, jointly with Professor Frankland, published a text-book on inorganic chemistry. In 1885 he was elected a fellow of the Royal Society.

**JAPURA** OR **YAPURA**, a river of Brazil and Colombia which rises in the Cordillera Centra of the Andes in southwestern Colombia, near Bolivar, flows E.S.E. through that country, being known there as the Caqueta. It enters Brazil near lat.  $1^{\circ} 25'$  S. and long.  $69^{\circ} 44'$  W. It keeps the same general course, and reaches the Amazon through numerous channels, which extend over two hundred miles. Most of these channels, however, carry water from the Amazon to the Japura, the united body of water entering the Amazon lower down. It is lined with luxuriant forests, which are inhabited only by a few Indians and by rubber and sarsaparilla gatherers. Length, 1,750 miles, of which 760 are navigable by river boats. Of its upper course little is known.

**JARDINE**, SIR **WILLIAM**. See **ORNITHOLOGY**, Vol. XVIII, pp. 13, 16, 18.

**JARGOON**. See **JACINTH**, Vol. XIII, p. 532.

**JARVES**, **JAMES JACKSON**, an American critic and traveler; born in Boston, Massachusetts, Aug. 20, 1818; traveled extensively, visiting California, Mexico and Central America; and served as United States Consul in Honolulu, establishing a newspaper there, the *Polynesian*. He published a history of the Sandwich Islands, and having traveled in Europe produced *Art Hints* (1855) and *Art Studies* (1861), being critical considerations of famous pictures and statuary. He resided alternately in Paris and Florence for a long time, meanwhile accumulating a gallery of old masters, illustrating the history of Italian art, which subsequently became the property of Yale College. *Italian Rambles* (1884) and *The Art of Japan* (1876) were later works of his. He died in Switzerland, June 28, 1888.

**JARVIS**, **ABRAHAM**, an American Protestant Episcopal bishop; born in Norwalk, Connecticut, May 5, 1739; was graduated at Yale, and in 1764 was ordained a priest in the Protestant Episcopal Church; in the same year became rector of Christ Church, Middletown, and in 1797 was consecrated bishop of Connecticut. He took up his residence at New Haven, where he died, May 3, 1813.—His son, **SAMUEL FARMER JARVIS**, was born in Middletown, Connecticut, Jan. 20, 1786; was graduated at Yale in 1805, and in 1810 was ordained to the ministry; took charge of a church at Bloomingdale, New York, and afterward of a church in New York City, which he retained until 1819, when he was chosen professor of biblical learning in the General Theological Seminary, in New York. From 1820 to 1826 he was rector of St. Paul's Church, Boston. He then went to Europe for research in church history and the study of art. Nine years later he returned, and became professor of oriental literature at Trinity College, Hartford, but resigned in 1837 to become rector of Christ Church, Middletown, and in 1838 was appointed historiographer to the American Episcopal Church. In this connection he published in London, in 1844, a *Chronological Introduction to the History of the Church*. In addition, he wrote *No Union with Rome* (1843) and *The Church of the Redeemed* (1845). He died in Middletown, March 26, 1851.

**JARVIS**, **EDWARD**, an American author and physiologist; born in Concord, Massachusetts, Jan. 9, 1803; was graduated at Harvard in 1826, and practiced medicine in Massachusetts, where he became well known as an authority on insanity. In 1852 Dr. Jarvis became president of the American Statistical Association, and in this capacity prepared a large number of reports and tables on public health, longevity, mortality-rates and other matters pertaining to state medicine. He also wrote *Practical Physiology* (1848); and *Primary Physiology* (1849). He died at Dorchester, Massachusetts, Oct. 31, 1884.

**JASHAR**, **BOOK OF**. See **HEBREW LANGUAGE AND LITERATURE**, Vol. XI, p. 598.

**JASPER**, a town and the capital of Dubois county, southwestern Indiana; on the Patoka River and the Louisville, Evansville and St. Louis railroad; forty-five miles N.E. of Evansville. Block coal and iron are mined here, and lumber, flour, carriages, farming-implements, office-desks and wood-work are manufactured. Tobacco is the principal agricultural product. Population 1890, 1,281; 1900, 1,863.

**JASPER**, **WILLIAM**, an American soldier; known in history as **SERGEANT JASPER**; born in South Carolina about 1750; enlisted at the outbreak of the Revolutionary War, in the Second South Carolina Regiment, and was one of the garrison of Fort Moultrie when it was attacked by the British fleet in 1776. Early in the action the colors were shot away, but Jasper, leaping through an embrasure in a perfect storm of cannon-shot, recovered the flag and planted it again upon the walls. In recognition of his bravery, Governor Rutledge gave him his own sword and offered him a commission, which he refused, because, as he said, he was "not fit to keep officers' company, but only a sergeant." Colonel Moultrie, however, gave him command of a roving squad, and in operations upon the outposts he often distinguished himself. In the attack upon Savannah, Oct. 9, 1779, Sergeant Jasper accompanied D'Estaing and Lincoln, and was killed while attempting to fasten the colors of his regiment to the parapet.

**JASTROW**, **MARCUS MORDECAI**, a Polish-American rabbi, born at Rogasen, Prussia, June 5, 1829. After studying at Berlin and graduating at Halle, he became preacher and assistant rabbi at Warsaw in 1858. Being banished in 1862 he became rabbi at Mannheim, but was soon recalled to Warsaw, where he remained till 1864. In 1866 a German-Hebrew congregation called him to Philadelphia, Pennsylvania, where he acted as rabbi. His principal works are *Four Hundred Years of Jewish History* (1865); *Episodes of Jewish History*; and a *Complete Talmudic Dictionary* (1889).

**JATAKA** (literally, "relating to birth"), folk-lore. See **BUDDHISM**, Vol. IV, p. 430.

**JAVA DEER**, the pigmy musk-deer (*Tragulus Javanicus*), common in the East Indies and in southern Asia. There are several species in this region. They are easily tamed.

**JAVARI** OR **YAVARI**, a river of South America, rising in the northwestern part of Bolivia, and taking a semicircular course, flowing N.W., N.N.E. and E., forming the boundary between Brazil and Peru.

and emptying into the Amazon at Tabotinga, lat. 70° W. It is 450 miles long, and is navigable for 200 miles. It is surrounded by heavily forested lands. See BRAZIL, Vol. IV, p. 221.

JAVA SPARROW, a large finch (*Padda oryzivora*), common in the East Indies and in southern Asia. The general color is gray, with white cheeks and black tail. See WEAVER BIRD, Vol. XXIV, p. 463.

JAVELLE WATER. See EAU DE JAVELLE, in these supplements.

JAXARTES, river. See SYR DARIA, Vol. XXII, pp. 818, 819.

JAY, JOHN, an American diplomatist; son of William Jay; born in New York City, June 23, 1817; graduated at Columbia College, in 1836. He was admitted to the New York bar in 1839, and in 1869 was sent as minister to Austria. He negotiated a naturalization treaty, and a convention on trademarks, and supervised the United States commission to the World's Fair of 1873 at Vienna. He resigned in 1875, and in 1877 was chairman of the commission to investigate the system of the New York custom-house. Mr. Jay was a member of various geographical and historical societies, and published many speeches and pamphlets; among them *America Free or America Slave* (1856); *The Church and the Rebellion* (1863); *Rome and America* (1868); and *The Public School a Portal to the Civil Service*. He died in New York City, May 5, 1894.

JAY, WILLIAM, an American jurist, son of Chief Justice John Jay; born in New York City, June 16, 1789; graduated at Yale, and studied law. In 1818 he was appointed to the bench of Westchester County, New York, and was reappointed until 1842, when he was superseded on account of his anti-slavery views. He was active in anti-slavery and temperance movements; was for several years president of the American Peace Society, and one of the chief founders of the American Bible Society. Among his writings are the *Life of John Jay, with Selections from His Writings* (1833); *A View of the Action of the Federal Government in Behalf of Slavery* (1839); *War and Peace* (1848). He died at Bedford, New York, Oct. 14, 1858.

JAY'S TREATY. See FEDERALIST PARTY, in these Supplements.

JEAFFRESON, JOHN CORDY, an English author; born at Framlingham, Suffolk, Jan. 14, 1831. He was educated at Pembroke College, Oxford, and called to the bar at Middle Temple, in 1859. He contributed to *Fraser's Magazine*, *The Dublin University Magazine*, *Temple Bar*, *The Athenaeum* and the daily press of London. Among his numerous novels are *Crewe Rise* (1854); *Not Dead Yet* (1864); *A Woman in Spite of Herself* (1872); and *Cutting for Partners* (1890). He published a series of now well-known books from 1860 to 1874, which deal with social history. The titles of these are *A Book About Doctors* (1860); *A Book About Lawyers* (1866); *A Book About the Clergy* (1870); *Brides and Bridals* (1872); *A Book About the Table* (1874). Besides these works of fiction, Jeaffreson also contributed to the history of English literature *Novels and Novelists from Elizabeth to Victoria* (1858); *The Real Lord*

*Byron* (1883); *The Real Shelley* (1885); *Lady Hamilton and Lord Nelson* (1888); *Victoria, Queen and Empress* (1893); and *A Book of Recollections* (1893).

JEANETTE, a borough of Westmoreland County, southwestern Pennsylvania, on the Pennsylvania railroad, 21 miles E.S.E. of Pittsburg. It has manufactures of plate, window and decorated glass, tableware, tannin, carbon and bricks. Population 1890, 3,296; 1900, 5,865.

JEBB, RICHARD CLAVERHOUSE, an English educator; born at Dundee, Scotland, Aug. 27, 1841. He passed with marked distinction through St. Columba's College, Dublin, Charterhouse School, London, and Trinity College, Cambridge, graduating as senior classic in 1862. Soon after, he was elected fellow of his college, and took a prominent part in organizing the system of inter-collegiate classical lectures, and served as secretary of the newly founded Cambridge Philological Society. In 1869 he became public orator of the university, in 1872 classical examiner in the University of London, and tutor of his own college, in 1875 professor of Greek in the university of Glasgow, and in 1891 regius professor of Greek at Cambridge. He received from the King of Greece the Gold Cross of the Order of the Saviour, in recognition of his services in promoting the study of both classical and modern Greek. Among the most important of his works are *Modern Greece* (1880); a *Life of Richard Bentley* (1882); and *The Attic Orators* (1893). He began on a translation of the complete works of Sophocles. In 1892 he was elected to Parliament by Cambridge University. He contributed the articles on ARISTOPHANES, DEMOSTHENES and other classical subjects and on RHETORIC to this ENCYCLOPEDIA.

JEDDAH. See JIDDAH, Vol. XIII, p. 691.

JEDDO. See TOKIO, Vol. XXIII, pp. 432-434.

JEFFERIES, JOHN RICHARD, an English naturalist and author; born at the farm-house of Coate, near Swindon, Wiltshire, England, Nov. 6, 1848. Commencing life as a journalist, he soon attracted popular attention as a writer on rural subjects, his vigor and felicity of style, rare acquaintance with animal life and passionate love of nature obtaining grateful recognition among his readers. Like White of Selborne and Thoreau of Concord, he possessed the happy faculty of transfiguring the humblest objects related to his daily surroundings, investing them with vivid and abiding interest. Yet his excursions at times led him far afield, and many comparatively unfamiliar spots, by his tender, lucid insight were endeared to the British public—to the rustic dwellers amid the haunts he loved, as well as to metropolitan denizens. His descriptions of nature were luminous and poetic, transfused with grace and the meditative hue of his own engaging personality, and of a finely



JOHN R. JEFFERIES.

native quality seldom observed in writings of this order. It is pathetic to remember that the intensity of feeling for human life and the fervid longing for perfection of animal health and spirits which constitute the brightness and charm of his creations, were in sad contrast with a wasted physique and the distress of a lingering, incurable malady. His works, considering his brief experience as an author, are voluminous, ranging over a wide field of philosophical experience, among the best known, perhaps, being *The Gamekeeper at Home* (1878); *Wild Life in a Southern County* (1879); *The Amateur Poacher* (1879); *Nature Near London* (1883); *The Dewy Morn* (1884); and *The Open Air* (1885). His last essays, *Field and Hedgerows* (1889), collected by his widow, reflect the early enthusiasm with which his boyhood musings are aflame, powerfully portrayed in *The Story of My Heart* (1883), in the pages of which the subtlest emotions of his throbbing spirit are eloquently recorded. He died Aug. 14, 1887, after a long and painful illness. Beneath the bust of the author unveiled in Salisbury Cathedral is the following appreciative tribute: "To the memory of Richard Jefferies, . . . who, observing the works of Almighty God with a poet's eye, has enriched the literature of his country and made for himself a place among those who have made men happier and wiser." *The Eulogy of Richard Jefferies* has been fittingly written by Sir Walter Besant.

**JEFFERSON**, a town and the capital of Greene County, Iowa, situated on Coon River, fifty miles northwest of Des Moines, on the Chicago and Northwestern and the Des Moines, Northern and Western railroads. It has manufactories of flour and cigars, and is in a natural-gas field. Population 1890, 1,875; 1900, 2,601.

**JEFFERSON**, a village and the capital of Ash-tabula County, northeastern Ohio; on the Franklin division of the Lake Shore and Michigan Southern railroad, thirteen miles south of Lake Erie. It is surrounded by a rich grazing, grape-raising and dairy country. Population 1900, 1,319.

**JEFFERSON**, a city and the capital of Marion County, northeastern Texas, at the head of navigation on Big Cypress Bayou, and on the Sherman, Shreveport and Southern and the Texas and Pacific railroads. It is a thriving manufacturing city, the largest of northeastern Texas, and the center of river commerce, exporting cattle, barreled beef, tallow, hides, wool, osage-orange seed, lumber, iron and large quantities of cotton. Large beds of coal and iron are found in the vicinity. Population 1890, 3,072; 1900, 2,850.

**JEFFERSON**, a city and the capital of Jefferson County, southeastern Wisconsin, situated at the union of Crawfish and Rock rivers and on the Chicago and Northwestern railroad, 48 miles W. of Milwaukee. It is the center of a rich agricultural district, and has manufactories of cream-brick, agricultural tools, boots and shoes, furniture and cigars; and it has tanneries, pork-packing houses and breweries. Population 1900, 2,584.

**JEFFERSON, JOSEPH**, an American actor; born in Philadelphia, Feb. 20, 1829. His grandfather and great-grandfather were distinguished actors, and

his mother, Mrs. Burke, was a celebrated vocalist. He appeared on the stage at a very early age, in the character of the child in *Pizarro: or, the Death of Rollo*, and in 1843 traveled through Mexico and Texas with a company of strolling players. He soon rose to the front place as a comedian, and his merits are recognized in both England and America. His range of characters was very wide, covering almost the entire field of comedy and farce, without degener-



JOSEPH JEFFERSON.

erating into burlesque. His most famous rôle is that of Rip Van Winkle in Dion Boucicault's play of that name, founded upon the story by Washington Irving, a character which Mr. Jefferson may be said to have created as well as to have made his own. As he first appeared in it the play was crude and inartistic, but it was rewritten especially for him by Mr. Boucicault in 1865, and put on the stage of the London Adelphi in September of that year, where it ran for over 150 nights. He repeated his triumph in New York the next year, and for several years thereafter he played in nothing else. Perhaps he was equally successful as Bob Acres in *The Rivals*. In 1890 he published an autobiography. His son, Joseph Jefferson, Jr., is also an actor of decided ability. He appeared in 1896 at the head of a special company, made up of the leading actors and actresses of the United States, in a star production of *The Rivals*.

**JEFFERSON CITY**, the capital of the state of Missouri and of Cole County, situated on the south bank of the Missouri River, 150 miles from its mouth, on the Missouri Pacific and the Chicago and Alton railroads. Jefferson City contains the state-house, a court-house, the state-prison, the Lincoln Institute, a female seminary, several banks and churches, and manufactories of farming-implements, wagons, shoes, brick; and brewery, foundry and machine-shop products. Coal and limestone are found in the vicinity. The city is supplied with water-works, electric and gas lights. Population 1900, 9,664. See **JEFFERSON CITY**, Vol. XIII, p. 616.

**JEFFERSONIA**, a North American genus of *Berberidaceæ*, of one species, *J. diphylla*, native in rich woods throughout the states east of the plains. From the root-stock in early spring the rears a solitary white flower upon a long scape, the sepals falling off when the flower opens, and a little later a pair of long-petioled and lobed leaves. The ovate pod opens by a conical lid. The popular names are twin-leaf and rheumatism-root.

**JEFFERSON MEDICAL COLLEGE**, an institution, originally the medical department of Jefferson College, at Cannonsburg, Pennsylvania; founded in 1826, largely through the efforts of Dr. George McClellan, but in 1836 incorporated as a separate institution, under the name of the Jefferson Medical College of Philadelphia. Its graduates number about

10,000. In 1893 there were 73 instructors and 624 students.

**JEFFERSONVILLE**, a town and magisterial district in Montgomery County, Ky. The town is supplied with city water and gas and electric lights, and has new manufactories of farming tools and flour and lumber mills. Pop. district and town, 1900, 2,280. See **JEFFERSONVILLE**, Vol. XIII, p. 616.

**JEFFRIES, JOHN**, an American surgeon; born in Boston, Massachusetts, Feb. 5, 1744; graduated at Harvard, and studied medicine in London and Aberdeen. He returned to Boston in 1769; but on the evacuation of that city in 1776, accompanied the British army to Halifax, and was appointed surgeon-general of the forces in Nova Scotia by General Howe, and in 1779 surgeon-general of the British forces in America, with headquarters in Savannah. Returning to London at the close of hostilities, he devoted himself to practice with great success, and also to scientific experiments upon atmospheric phenomena; and, to test the practicability of aerial navigation, made two balloon ascensions; in the second, Jan. 7, 1785, ascending from the cliffs of Dover and alighting in the northeastern part of France. In 1789 Dr. Jeffries returned to Boston, where he gained great eminence, and still greater notoriety by attempting to give public lectures on anatomy; but on account of the great popular sentiment existing against dissection, he was compelled by mob violence to discontinue his course of instruction. He died in Boston, Massachusetts, Sept. 15, 1819.

**JEHU**. See **ISRAEL**, Vol. XIII, pp. 407, 408.

**JEISK OR YEISK**, a town of southern Russia, Province of Kuban, at the mouth of the Tscherlinkoeka River, on the sea of Azov. It has a large trade in grain, oil and linseed. Population 1886, 25,015.

**JELLACHICH VON BUZIM, COUNT JOSEPH**, Austrian general. See **AUSTRIA**, Vol. III, p. 137.

**JELLY-FISH**, a popular name given to those coelenterates which have a soft, gelatinous, transparent body. The name is given chiefly to the discophorean hydrozoa (*Siphomedusa*), which consists of a bell-shaped mass of jelly-like substance. They are very common at the seashore, and vary in shape from a tumbler to a saucer. Some resemble in form an expanded umbrella. They swim freely by the contraction of their bodies. The body varies in diameter from a fraction of an inch to three or four feet. Tentacles are arranged like a loose fringe around the margin of the bell or umbrella. Sense organs are found in definite positions on the margin of the body. The name is applied also to the comb-bearers or cenophores, and to the medusoid body of the *Hydromedusa*. The latter are bell-shaped forms of small size, which at the breeding-season grow upon the branching colony among the feeding-polyyps. They are set free and lead a free-swimming life. In them are produced the eggs and spermatozoa, and therefore they are reproductive animals.

**JEMBA**. See **EMBA**, in these Supplements.

**JENCKES, THOMAS ALLEN**, an American statesman; born at Cumberland, Rhode Island, Nov. 2, 1818. After graduating from Brown University, in

1838, he studied law and attained eminence in his profession. In 1841, during the disputes which led to Dorr's Rebellion, he was secretary of the land-holders' convention, and in 1842 of the convention which framed the constitution of the state. He served in both houses of the legislature, and in 1862 was elected to Congress, where he remained until 1871, being recognized as a high authority on legal questions. He was the author and advocate of a bill which established a uniform system of bankruptcy throughout the United States, and still more important were his efforts in introducing and securing the passage of a bill improving and regulating the civil service. He died at Cumberland, Nov. 5, 1875.

**JENKIN, HENRY CHARLES FLEEMING**, an English engineer and electrician; born at Stowting Court, Kent, March 25, 1803; educated at Jedburgh, Scotland, at Edinburgh Academy, and afterward on the continent, chiefly at Frankfort, Paris and Genoa. At the last he was graduated. Returning to England in 1851, he served for three years in one of the large engineering works of Manchester. For some time after this he was interested in railways, but in 1857 was put in charge of the electrical and engineering work pertaining to the manufacture of wire for the first Atlantic cable. Many years of his life were devoted to the laying of submarine cables in various parts of the world. He was appointed professor of engineering at the University of Edinburgh, in 1868. His most widely known work is *Electricity and Magnetism* (1870), which was translated into several languages and adopted as one of the series of *Text-Books of Science*. He also wrote the article on **BRIDGES** in this **ENCYCLOPEDIA**. He died in Edinburgh, June 12, 1885.

**JENKINS, CHARLES JONES**, an American jurist; born in Beaufort District (now County), South Carolina, Jan. 6, 1805; removed when quite young to Jefferson County, Georgia; educated at Georgia University and Union College, from the latter of which he was graduated; and, after being admitted to the bar, became a lawyer at Augusta. In 1831 he was elected attorney-general for the state, and from 1836 to 1850 was prominent as a Whig in the legislature, being speaker for several years. The Georgia Convention of 1850 adopted resolutions presented by him in favor of the Union, yet declaring that the state would resist any act of Congress abolishing slavery. In 1860 he was appointed a judge of the state supreme court, a position which he held till the close of the Civil War. He was a prominent member of the constitutional convention of the state, called under proclamation of President Johnson in 1865, and in the same year was elected governor under the new constitution. This constitution not being recognized by Congress, Jenkins retired into private life, but in 1877 was president of the state constitutional convention. He died at Summerville, Georgia, June 13, 1883.

**JENKINS, EDWARD**, a British author; born in Bangalore, India, in 1838. He was educated at McGill College, Montreal, and at the University of Pennsylvania. He was admitted to the bar in London in 1864 and practiced till 1873, when he entered



politics. From 1874 to 1876 he was agent-general for Canada, and then became a member of Parliament. Among his published works are *Ginx's Baby* (1870), a clever article on the problems of British pauperism and over-population; *The Colonies and Imperial Unity* (1871); and *The Coolie* (1871).

JENKINS, JAMES G., an American jurist; born at Saratoga Springs, New York, Jan. 18, 1834. His mother was the eldest child of Reuben H. Walworth, the last chancellor of New York state, and a jurist of national reputation. Mr. Jenkins was educated for the bar in his own state, and in 1855 was admitted to practice before the supreme court of the United States. He went to Wisconsin in 1857, and for many years was a successful practitioner there. He succeeded Judge Andrew J. Miller, on his death, on the bench of the United States district court, in 1885. In March, 1893, he was appointed by President Cleveland to fill the place made vacant by Judge W. Q. Gresham, on the bench of the seventh circuit court of the United States, on that gentleman's acceptance of the portfolio of Secretary of State in the Cleveland Cabinet. Judge Jenkins's decision in 1894, in which he denied the right of employees to combine for the purpose of striking, attracted very wide attention.

JENKINS, THORNTON ALEXANDER, a United States naval officer; born in Orange County, Virginia, Dec. 11, 1811. He entered the navy in 1828 as a midshipman; was made a lieutenant in 1839; was engaged in several important actions during the Mexican War; in 1852 became secretary of the light-house board; was promoted commander in 1855; was made captain in 1862; commodore in 1866, and rear-admiral in 1870. He was retired in 1873, and at the Centennial Exhibition at Philadelphia in 1876 had charge of the exhibit of the Naval Department. He wrote many reports for the government. Died in Washington, D. C., Aug. 9, 1893.

JENKS, JEREMIAH WHIPPLE, an American educator; born at St. Clair, Michigan, Sept. 2, 1856; educated at the University of Michigan and at Halle, Germany; was professor of political science and English literature at Knox College, Galesburg, Illinois; professor of economics and social science at Indiana State University, Bloomington, and in 1891 became professor of political, municipal and social institutions at Cornell University. He wrote *Henry C. Carey, Als National-ökonom* (1885); *Road Legislation for the American State* (1887); and numerous other articles.

JENKS, JOSEPH, an English inventor; born at Hammersmith, near London; emigrated to Lynn, Massachusetts, about 1645, and on May 6, 1646, the first patent issued in North America was granted him by the Massachusetts general court "for the making of engines for mills to go by water." He later got patents for making scythes and other edged tools. The scythe which he invented was essentially the same as the hand-implement in use to-day. He is said to have made the dies for the silver coinage of the colonies in 1652; he was the first founder in brass and iron in America, and also gave considerable attention to the drawing of wire. He died in Lynn, in 1683.

JENNER, SIR WILLIAM, an English physician; born at Chatham in 1815; and educated at University College, London, where he himself was professor from 1848 to 1879. In 1861 he was appointed physician to the Queen, and attended the Prince Consort in his last illness. He was a member of numerous scientific societies, contributed largely to medical literature, and was the first to establish the difference in kind between typhus and typhoid fevers. He wrote several series of papers on fever, the acute specific diseases, diphtheria, diseases of children, diseases of the heart, lungs, skin, etc. He was created a baronet in 1868 and made a K.C.B. Jan. 20, 1872, in recognition of services rendered during the severe illness of the Prince of Wales. He was president of the College of Physicians from 1881 to 1889, when he retired from professional practice. Died in Bishop's Waltham, Dec. 11, 1893.

JENNET OR HINNY. See MULE. Vol. XVII, p. 13.

JENNIE JUNE. See CROLY, JANE CUNNINGHAM, in these Supplements.

JEQUITINHONHA, river, BRAZIL. See Vol. IV, p. 222.

JERICHAU, JENS ADOLF, a Danish sculptor; born at Assens, Island of Fünen, April 17, 1816. After studying at home, he went to Rome and became a pupil of his countryman, Thorwaldsen. While in Rome he married the artist Elizabeth Baumann, and in 1849 returned to Copenhagen. His principal works are *The Marriage of Alexander and Roxana*; *Hercules and Hebe*; *Penelope's Ascension*, which took the grand prize given by the Princess Albert of Prussia; and *The Panther Hunter*. Besides these works are the monuments to Oersted and Hans Christian Andersen, at Copenhagen. Jerichau died July 24, 1883. His wife ANNE MARIE ELIZABETH BAUMANN JERICHAU, born at Warsaw, Poland, in 1819; studied art at the Academy of Düsseldorf until 1845, when she went to Rome. Her work was principally of genre subjects. In 1861 she had an honorable mention at Paris. Among her works are *The Joys of a Mother*; *The Wounded Soldier*; and *A Scene on the Nile*. She died in 1881. A son of these two artists, HARALD ADOLPH NIKOLAI, born Aug. 17, 1852, died March 6, 1878, was a landscape painter of note.

JERICO, a city of Colombia, in the department of Boyaca, near the Chicamocha River. The climate of the region is very healthful, and stock-raising is the principal industry. The city is modern, has a good trade and is growing rapidly. Population 1892, 11,593.

JEROBOAM. See ISRAEL, Vol. XIII, p. 406.

JEROME. JEROME KLAFFKA, an English humorist; born at Walsall, Staffordshire, May 2, 1861; was educated at the Philological School of Marylebone. He was employed first as a clerk at the Euston offices of the London and



JEROME K. JEROME.

Northwestern Railroad Company, and subsequently became in succession actor, journalist, tutor, shorthand writer and solicitor's clerk till 1889, when he published *On the Stage and Off*, and then the *Idle Thoughts of an Idle Fellow*. *Three Men in a Boat* made its appearance in 1889; *Novel Notes*, in 1893; and *John Ingerfield and Other Stories*, in 1894. As a dramatic author he also earned distinction. In 1892 he became part proprietor of a magazine, *The Idler*, and in November, 1893, proprietor of *To-day*, a new weekly magazine journal.

JERROLD, WILLIAM BLANCHARD, an English author; born in London, in 1826. After being educated partly in France, he became a journalist, and also produced many farces and comedies; among others, *Cool as a Cucumber* (1851); and *Cupid in Waiting* (1870). In 1855 he attended the Paris Exhibition as agent of the London *Daily News*. In 1862 he wrote a series of articles on the London poor for the *Morning Post*, and during the next year he went to Paris to examine its institutions for the poor, and some years later he visited the Netherlands for the same purpose. Among his published writings are *At Home in Paris* (1871); *Trip Through the Vineyards of Spain* (1864); *The Cockaynes* (1871); *Life of Napoleon III* (1874-82); and *Egypt under Ismail Pasha* (1879). He died March 10, 1884.

JERSEY CITY, a city and the capital of Hudson County, northeastern New Jersey. See JERSEY CITY, Vol. XIII, p. 635. The streets are generally laid out at right angles, and are of good width, well paved, sewerred, lighted with gas and electricity and bordered by many handsome residences. Jersey City is the terminus of the Red Star line of steamships to Europe, and of a dozen railroads running in various directions. Immense quantities of iron, coal, produce and general merchandise are brought to and shipped from this city. There are horse and electric railroads to Hoboken and various parts of the city itself. It contains upward of sixty churches, a high-school, a normal-school, several banks and many charitable and educational institutions. The city is supplied with water conveyed in pipes from the Passaic River by means of hydraulic works, which are at Belleville, six miles distant. Jersey City has many and various manufacturing establishments, among which the more recently developed are locomotive and railroad supply works, planing-mills, potteries, manufactories of chemicals, jewelry, fireworks, lead-pencils, hydrants, chains, rubber goods, castor and linseed oil, copper-ware, oakum, chains and spikes, car-springs, etc. European markets, as well as those of the United States, obtain their crucibles from the works of Jersey City. There are also large stock-yards and an extensive abattoir, where vast quantities of cattle and sheep are slaughtered for the New York markets. The capital of all the manufactories aggregates over \$18,000,000, and the value of their annual products averages over \$37,000,000. They employ 13,000 hands, and pay about \$8,000,000 a year in wages. Of these, the manufacture of machinery, soap and candles and of chemicals, paints and varnishes has the largest investment. The city is governed by a mayor and board of aldermen, assisted by numerous

executive boards. There is an efficient police force and a well-equipped fire department. The valuation of taxable property is about \$85,000,000; the tax-rate was 2.75 per cent, and the net debt \$8,400,000. The site whereon Jersey City stands was formerly called Paulus Hook, but in 1820 was chartered as "The City of Jersey," and in 1838 as "Jersey City" Pop. 1890, 163,987; 1900, 206,433.

JERSEY SHORE, a borough of Lycoming County, northeastern central Pennsylvania, 10 miles S.W. of Williamsport, on the west branch of the Susquehanna, and on the Pennsylvania, the Fall Brook and the Beech Creek railroads. The region has fine scenery, is fertile, and produces lumber and tobacco. Population 1900, 3,070.

JERSEYVILLE, a city and the capital of Jersey County, southwestern Illinois, on the Chicago and Alton and the St. Louis, Chicago and St. Paul railroads, 33 miles N. of St. Louis. It manufactures flour, plows, reapers, carriages and wagons, watch-making machinery, and contains railroad repair-shops, and a farm for raising thoroughbred horses. It is lighted with electricity, and has an artesian well water-supply. Population 1900, 3,517.

JERUSALEM ARTICHOKE. See HORTICULTURE, Vol. XII, p. 283.

JERUSALEM CHERRY, the common name of *Solanum Pseudocapsicum*, a shrubby house-plant from Maderia, cultivated for its bright red berries, which resemble cherries. It is a smooth plant, with lance-oblong entire leaves and small white flowers.

JERVIS, JOHN, EARL. See ST. VINCENT, Vol. XXI, p. 201.

JERVIS, JOHN BLOOMFIELD, an American engineer; born at Huntington, New York, Dec. 14, 1795. He was employed in the construction of the Erie canal, and afterward superintended the construction of the Delaware and Hudson canal. He invented the locomotive-truck, and was chief engineer of the Albany and Schenectady railroad; in 1836 he was appointed engineer in charge of the construction of the Croton aqueduct. He was later consulting-engineer of the Boston water-works, of the Hudson River railroad, of the Chicago, Rock Island and Pacific railroad, and of the Pittsburg, Fort Wayne and Chicago railroad, retiring from active duty in 1866. He published *Railway Property* (1866); *Labor and Capital* (1877); and was the author of several papers and lectures. He died Jan. 12, 1885.

JERVOIS, SIR WILLIAM FRANCIS DRUMMOND, military engineer and administrator; born at Cowes, Isle of Wight, Sept. 10, 1821; educated at the Royal Military Academy, and entered the Royal Engineers in 1839; after serving in South Africa (1841-48) he returned to England, and in 1856 was appointed assistant inspector-general of fortifications. In 1859, as secretary of a royal commission to report upon the defenses of the country, he prepared a memoir in which a system of fortifications for the security of vital points was proposed, and a plan for the defense of London suggested. He planned the fortifications for the principal English ports. He was sent on special missions in 1863-65 to examine into the state of the defenses in Canada.

In 1871 he was sent to India to advise with the Indian government respecting the defenses of Bombay, Aden, and other posts. In 1875-77 he was governor of the Straits Settlement, and quelled an insurrection in the Malay peninsula; was governor of South Australia, 1877-83, and of New Zealand, 1883-89. In 1890-91 he was on a Commission of Military Defenses. Died Aug. 17, 1897.

JESI OR IESI. See JESI, Vol. XIII, p. 644.

JESSAMINE. See JASMINE, Vol. XIII, p. 594.

JESSEL, SIR GEORGE, an English jurist; born in London, of Hebrew parents, in 1824. After studying at the University College, London, he was called to the bar at Lincoln's Inn in 1847, and in 1865 became a queen's counsel. He was elected to Parliament from Dover in 1868. In 1871 he was appointed Solicitor-General by Mr. Gladstone; knighted in 1872; made Master of the Rolls in 1873, and became the usual president of the Court of Appeals. He was the first of his race to hold a judicial office in England. He was regarded as the best equity lawyer in Great Britain. In 1880 Jessel was made vice-chancellor of the University of London. He died March 21, 1883.

JESSUP, HENRY HARRIS, an American missionary; born at Montrose, Pennsylvania, April 19, 1832; after graduating from Yale and Union Theological Seminary, he went as missionary to Tripoli, and later to Syria, where he took a leading part in the work of the Presbyterian station and college at Beirut. In 1879, while on a visit to the United States, he was elected moderator of the General Assembly at Saratoga. He published *Women of the Arabs, and Syrian Home Life* (1873); a translation into Arabic of Mosheim's *Church History* (1876); and *The Greek Church and Protestant Missions* (1891).

JESTER. See FOOL, Vol. IX, p. 366.

JESUITS IN NORTH AMERICA. (On JESUITS in general, see Vol. XIII, pp. 645-656.) In 1611 the Jesuit Fathers Biard and Masse accompanied the French expedition which laid the foundation of Acadia. Called upon by the original Recollet missionaries to take part in their labors in the then new colony of Quebec, the Jesuits settled in the valley of the St. Charles, near the confluence of that river with the Lariat, and there established the nursery of their order in America, known as Notre Dame des Anges, in 1625. When Quebec was captured by the English four years later, the Jesuit mission was suspended and the fathers driven off. In 1632, when the French recaptured the St. Lawrence River, the Jesuits returned, opened schools, established the College of Quebec, and sent out missionaries, who went up the river in canoes. After many hardships, and a journey of 900 miles by land and water, the missionaries found themselves in the Huron country, near the shores of Lake Huron. Here they founded mission schools, preached, farmed, and traded in furs with the French of Montreal and Quebec. In the year 1649 the Iroquois conquered the Hurons, burnt their villages, devastated their corn-fields, took their women and children prisoners, and burnt and tomahawked the Jesuit fathers.

But the Jesuits did not give up the task of estab-

lishing missions among the Indians. In 1649 they had establishments at Montreal, Three Rivers, and Quebec, a missionary post on the island of Miscon, in the Gulf of the St. Lawrence, another at Tadousac, near the mouth of the Great Saguenay River; and also posts among the Algonquins, on the Kennebec River, in Maine. Besides their activity as missionaries we find the Jesuits in North America taking part in many exploring expeditions. In 1671, when the Intendant Talon of New France resolved to take possession of the large valley of the Ottawas in the name of the King of France, the Jesuit Father Claude Allouez assisted him very materially, and took the chief part in the ceremonies incident to the great meeting of Indian tribes at Sainte-Marie-du-Sault. In the following year the French, under St. Simon and the Jesuit Father Albanel, rediscovered Hudson Bay.

Talon also sent, in the same year, a Quebec merchant named Joliet, and the Jesuit Father Marquette west to discover "Cathay" and the "South Sea." After wintering at Machelimackinac, these two explorers advanced early the next spring into the valley of the Illinois River, passing by way of the Fox River and the Wisconsin into the Mississippi as far as its confluence with the Arkansas. They returned in the fall and wintered at St. Francis Xavier, a missionary station on the west of Lake Michigan.

For the next hundred years the Jesuits continued their missionary, farming, teaching and exploring work with undiminished zeal and gratifying success, so that in 1720, when Charlevoix, a member of their society, visited Canada, he was prompted to congratulate his brethren warmly on their eminent services. But the English were at war with the French everywhere. So it came that Father Sebastian Rasle was shot down on the battle-field at Norridgewock, Maine, surrounded by his Indian neophytes; and when, in 1769, the British conquered New France, the College of Quebec, after flourishing for nearly 150 years, received its first severe blow. But it was still further crippled in 1773, when Pope Clement XIV suppressed the whole Jesuit order by a papal bull. Father Well, the last Jesuit survivor in Montreal, died in 1791, and Father Cazot, the last one in Quebec, passed away in 1800. After this the British government took all the Jesuit property in Canada, and turned the College of Quebec into barracks. It served as such until 1860, when England withdrew her troops from Canada. In 1880 the college building was torn down by order of the provincial government. In 1888 the Quebec Legislature, after prolonged discussion in and out of the Chamber, ratified an agreement by virtue of which \$400,000 was paid to the Society of Jesus in full settlement of the "Jesuit Estates Claims."

The work of the Jesuits begins in the United States when it ends in New France. After the War of Independence, Father John Carroll, an ardent Jesuit in Maryland, corresponded with the Holy See with the view to establishing a hierarchy in the United States. His scheme was accepted, and he himself was appointed and consecrated first bishop of Baltimore in 1790. The diocese of Baltimore remained for years the only Roman Catholic diocese

in the United States, and embraced all the states and territories of the Union. Carroll was the founder of Georgetown College, near Washington, in 1791, and he established a theological seminary in connection with this college, which, in 1792, was merged in that of St. Mary's, Baltimore. In 1815 Georgetown College was chartered as a university by act of Congress, and in 1833 it was empowered by the Holy See to confer degrees in philosophy and theology. This university is at present the largest school under Jesuitic control in the Union, and withal one of the best in the land. One of its principal offshoots is the College of the Holy Cross, at Worcester, Massachusetts.

In 1823 two Jesuits from Maryland traveled to Missouri and took ten young Marylanders with them. At Florissant, a few miles northwest of St. Louis, Missouri, they opened a school for Indian boys. In 1828 the Missouri Jesuits founded the St. Louis University, which was the first scholastic institution west of the Mississippi, and stands to-day high on the roll of American schools. Similar schools were gradually established by the Missouri fathers in Cincinnati, Ohio; Louisville and Bardstown, Kentucky; Grand Coteau, Louisiana; Chicago, Illinois; Milwaukee, Wisconsin; Detroit, Michigan; and Omaha, Nebraska. They have also auxiliary stations in all the important towns of the West.

In their efforts to convert and civilize the Indians, the Jesuits penetrated into the various Indian countries, beginning with the Pottawottomies in Kansas, ascending the Missouri to the Sioux encampment, and the Yellowstone to the Blackfeet. They labored among the Flatheads and the various other tribes of Indians west of the Rocky Mountains. One of them, Father De Smet, was on several occasions deputed by the United States government to pacify the Indians when they became violent by their unjust treatment at the hands of Indian agents or swindling traders. Father De Smet visited many of the tribes, and obtained from the government even the right of nominating agents for Catholic tribes.

During the revolutionary troubles in Europe in 1847-48, many Jesuits were driven from their colleges and sought refuge in America. The provinces of Maryland and Missouri obtained large reinforcements from the refugees. A number of the latter went to California in 1854 and began there a mission and a school, the college of Santa Clara, near San Francisco. The mission has since spread into Oregon and New Mexico. Some French Jesuits took possession of St. Mary's College, Marion County, Kentucky, in 1833, and laid, also, the foundation of another college in Louisville, Kentucky, in 1845. Early in 1846 they left the latter to take charge of St. John's College, New York, and also to establish a college for externs in New York City. About the same time a number of Jesuits went to New Orleans, where they opened a house, and took, soon after, also, the flourishing college of Springhill, near Mobile, Alabama. They have since added several stations throughout the Southwest.

The order of Jesuits was restored in 1814 by Pope Pius VII. After an absence of more than forty

years from Canada, the Jesuit fathers appeared once more on the banks of the St. Lawrence, in 1839; and the old College of Quebec was soon replaced by St. Mary's College, at Montreal, which stands unrivaled among the many flourishing institutions in Canada. In 1865 the Jesuits opened their beautiful church in Montreal, which is the counterpart of the Gesu, the mother-temple of their society in Rome. In 1885 the College of St. Boniface, opposite Winnipeg, in Manitoba, was transferred to the Jesuits of the Dominion.

At Woodstock, Maryland, a central institute has been established in which young Jesuits are thoroughly instructed in philosophy, physical science, mathematics and theology, with a view of preparing them for the priestly offices, and also for teaching all the higher branches of learning in the colleges and schools of their order.

JESULMIR OR JAISALMER, a town of Rajputana, western India, situated on a broad belt of low, rocky ridges, near a considerable lake. It is substantially built, of yellow sandstone chiefly, and overlooking it is a fort of great strength, in which are some Jain temples. It is the capital of the native state of the same name, a monotonous desert country, with a severe climate. Cattle, barley and millet are raised by the inhabitants. Population, 11,000.

JETSAM. See FLOTSAM, Vol. IX, p. 342.

JETTIES. See RIVER-ENGINEERING, Vol. XX, p. 577; and MISSISSIPPI RIVER, Vol. XVI, pp. 520, 521.

JETTISON. See AVERAGE, Vol. III, p. 146.

JEUNE, SIR FRANCIS HENRY, an English jurist; born in 1844; educated at Balliol College, Oxford, and called to the bar in 1868; made queen's counsel in 1888. In 1891 he was made judge of the Probate, Divorce and Admiralty Division; in 1892 president of the Probate and Divorce Court, and later advocate-general of her Majesty's forces. He was junior counsel for the claimant in the Tichborne case.

JEVONS, WILLIAM STANLEY, an English political economist; born in Liverpool, Sept. 1, 1835. He was educated at the University College, London, and at the London University; spent five years at Sydney, Australia, as an employee in the mint. In 1866 he was appointed professor of logic, political economy and mental philosophy at Owens College, Manchester. In 1876 he became professor of political economy at University College, London. After 1881 he devoted himself entirely to literary work. He published *A Serious Fall in the Value of Gold* (1863); *Pure Logic* (1864); *The Coal Question* (1865); *Elementary Lessons in Logic* (1871); *The Theory of Political Economy* (1871); *Principles of Science* (2 vols., 1874); *Money and the Mechanism of Exchange* (1875); *Investigations in Currency and Finance* (1884). Died at Boxhill, Aug. 13, 1882.

JEWELL, MARSHALL, an American statesman; born in Winchester, New Hampshire, Oct. 20, 1825. His father removed to Hartford and started a leather-beltng business. The son learned the trade and then went West, learned telegraphy and was an operator for three years. He returned in

1850 and re-entered his father's business. In 1869 he was elected governor of Connecticut and again in 1871 and 1872; in 1873 appointed minister to Russia; in 1874 chosen Postmaster-General in Grant's Cabinet, but resigned in 1876. He was chairman of the National Republican Committee during the Garfield campaign in 1880. Jewell's policy while Postmaster-General led to the discovery of the star-route scandals and was the cause of many wholesome reforms in the department. He died in Hartford, Feb. 10, 1883.

JEWETT, MILO PARKER, an American educator; born at St. Johnsbury, Vermont, April 27, 1808; graduated at Dartmouth in 1828, at the Andover Theological Seminary in 1833; accepted a professorship at Marietta College; became a Baptist in 1838; resigned his professorship and founded the Judson Female Institute in Marion, Alabama; in 1855 established a school for girls at Poughkeepsie. In 1862 he was chosen the first president of Vassar College, having suggested to Matthew Vassar the institution of such a school some time before. He resigned in 1864, and three years later settled at Milwaukee, Wisconsin, where he died, June 9, 1882.

JEWETT, SARAH ORNE, an American authoress; born at South Berwick, Maine, Sept. 3, 1849.



SARAH ORNE JEWETT.

She was educated at the Berwick Academy, and traveled in Europe and America. Her writings consist largely of short stories and novels portraying provincial life in New England. Among her works are *Deephaven* (1877); *Old Friends and New* (1879); *A Marsh Island* (1885); *The King of Folley Island* (1888); *A Native of Winby* (1893); and *The Life of Nancy* (1895). Miss Jewett resided in South Berwick and Boston.

JEWFSH, a local name of several American fishes of the family *Serranidae*. The name is applied chiefly to the genus *Promiclops*, the largest serranoid fish in American waters. It reaches a weight of 600 pounds. The names black grouper, guasa or warsau are also used. The *Stereolepis* of the warmer waters of the Pacific coast is also known as jewfish. It is almost as large as the first-mentioned, and is an excellent food-fish.

JEWISH LITERATURE. See BIBLE, Vol. III, pp. 634-641; APOCALYPTIC LITERATURE, Vol. II, pp. 175-179; SEMITIC LANGUAGES, Vol. XXI, pp. 645, 646; TALMUD, Vol. XXIII, pp. 35-39; JEWS, Vol. XIII, p. 682.

JEX-BLAKE, THOMAS WILLIAM, an English scholar and ecclesiastic; born in London, Jan. 26, 1832. He was graduated with honors at Oxford in 1855, and was elected a fellow of Queen's College in the same year. He was ordained priest in 1857, and became assistant master at Rugby in 1858; head master in February, 1874, a position which he re-

signed in 1886. In 1887 he was appointed rector of Alvechurch, in the diocese of Worcester; and dean of Wells in 1891. He was the author of *Long Vacation in Continental Picture-Galleries*, and a volume of sermons entitled *Life by Faith*.

JEZEBEL. See AHAB, Vol. I, pp. 420, 421.

JEZIRA. See MESOPOTAMIA, Vol. XVI, p. 48.

JHILAM. See JHELM, Vol. XIII, p. 690.

JIGGER. See FLEA, Vol. IX, p. 301.

JINN. See MOHAMMEDANISM, Vol. XVI, p. 546, note.

JINRIKISHIA. See JAPAN, Vol. XIII, p. 577.

JIRECEK, HERMENEGILD AND JOSEPH, brothers, and CONSTANTINE, son of JOSEPH, historical writers. See SLAVS, Vol. XXII, p. 153.

JOAB, a Jewish general, the son of Zeruiah, the sister of David, was born about 1053 B.C. He first came into prominence in the battle of Gibeon, as the leader of the people of Judah, who supported King David against the people of Israel under Abner, the former commander-in-chief of Saul, and the supporter of Saul's son in his pretensions to the throne of Israel. In this battle Abner slew the brother of Joab. Later, however, Abner became reconciled to David, and Joab, either fearing his influence in the kingdom, or in revenge for the death of his brother, killed Abner. Joab's advance was rapid now, and for a long time he was acting general in all of David's wars. He also made his influence felt at court. When Absalom lost the favor of the king by the murder of Amnon, Joab secured his reinstatement by a clever trick. But in Absalom's rebellion Joab sided with the king, and even slew Absalom, against David's own command. Later, another rival to Joab's ambitions presented himself, in the person of Amasa, to whom David transferred the chief command of his armies. Him also Joab murdered while pretending to welcome him. At last, however, "though he had not turned after Absalom, he turned after Adonijah," and was slain in the tabernacle at Gibeon by Benaiah, 1012 B.C., by order of King Solomon.

JOACHIM, JOSEPH, a German violinist; born June 28, 1831, at Kittsee, near Pressburg, Hungary,

of Jewish parents. He displayed great talents on the violin at the age of five, and was placed under Szervacinsky, the opera conductor at Budapest. In 1841 he became the pupil of Boehm in Vienna, and two years later went to the Conservatorium in Leipsic, which was then under the direction of Mendelssohn. Here, at the age of 12, he made his first public appearance, Mendelssohn being his accompanist. He remained in Leipsic until 1849, pursuing his musical studies under David, and at the same time acquiring a thorough general education. In 1849 Joachim accepted the leadership of the grand duke's orchestra at Weimar, but gave up this post in 1854



JOSEPH JOACHIM.

to accept the appointment of conductor of concerts and solo-violinist to the King of Hanover. In 1868 he went to Berlin to take charge of the new school of musical execution which had been founded as a department of the Academy of Arts. Joachim was a master of technique, and his style was recognized universally as a model. His repertoire consisted almost entirely of the classical works for the violin by Bach, Beethoven, and Mendelssohn. As a composer he belongs to the school of Schumann. His most important work is the Hungarian Concerto (op. 11).

JOGUES, ISAAC, a French Jesuit missionary to Canada; born at Orleans, Jan. 10, 1607; joined the order of Jesuits in 1624; became a priest, and was sent to the New World as missionary to the Hurons in 1636. He sailed up the St. Lawrence and Ottawa rivers into the Huron country, east of Lake Superior. After five years' missionary work he started to return to Quebec, was taken prisoner by the Mohawk Indians and tortured, but finally escaped to Albany, and returned to France by way of New York. He soon returned to Canada, negotiated a treaty between the French and the Mohawks in 1646, and began a mission among the latter, but was killed as a sorcerer by them, Oct. 18, 1646, in a part of the country which is now Montgomery County, New York. In 1884 a chapel was built on the spot, and steps have been taken toward his canonization. His *Life* was published by Felix Martin in 1873.

JOHANNESBURG, the largest town in the Vaal River colony, and the mining centre of the Witwatersrand gold-fields. It is situated 298 miles N. E. of Kimberley and 35 S. of Pretoria, the capital of the colony. The town was originally known as Ferreira's mining-camp and has had a phenomenal growth. Three railroad lines connect it with the Delagoa Bay, Durban, Port Elizabeth and Cape Town. The first line was opened in 1892 and the Pretoria-Delagoa Bay railway was completed in the autumn of 1894. The extension of the Rand line to Charlestown, where it meets the Natal railway, was opened for traffic in 1895. Fine banks, churches, hotels, clubhouses, stores, private houses and a handsome stock exchange have been erected. The population in 1895 exceeded 40,000, with an additional 32,000 in the adjoining gold-fields. The water-supply and sanitary arrangements are insufficient and defective. Dust-storms are frequent and epidemics of fever occasional.

In December, 1895, the Uitlander or foreign-born population petitioned the Volksraad to remove the franchise qualifications, which then required 15 years' residence in the Transvaal, the renunciation of British allegiance and membership in the Dutch Reformed Church. The proposal was treated contemptuously by the Boer Volksraad, and as a result the agitation started which ended in the Jameson Raid. The administration of the South African Republic has been hitherto corrupt and oligarchical in the extreme. The railroad, whiskey, and dynamite concessions were in the hands of Germans, and all foreigners were heavily taxed, without any right of representation in local affairs. On the surrender of Dr. Jameson and the failure of his

raid, the reformer's committee were arrested by the Boer authorities, and on April 28, 1896, the four principal leaders were sentenced to death. The sentence was immediately commuted, and on June 11th they were released, after paying fines of \$125,000 each. The Boers then commenced to erect forts commanding Johannesburg, and were said to have received the assistance of many German military men. In 1899, the Uitlander element in the city and adjacent mining region continued to be the object of hatred, suspicion, and petty tyranny, on the part of the Boer government at Pretoria. This became so intolerable that a petition, signed by 21,000 British subjects, was addressed to Her Britannic Majesty complaining of grievances and of the failure of the Transvaal authorities to grant reforms. This led to many months of diplomatic parley between the Boer Republic and the suzerain power, the Republic insisting that before any conference was agreed to on the part of the burghers, Britain should waive suzerainty and abandon what rights she had through the conventions of 1881 and 1884. The English government repeatedly assured the Boers that it had no desire to interfere with the autonomy of the Transvaal or in any degree to aggress upon the Republic. All she desired was justice and fair dealing to British subjects in the Republic, with such representation in the Raad (Legislature) as they were entitled to, and which would enable them to secure that fair and just treatment promised them in 1881 when Britain granted self-government to the Transvaal. The negotiations, however, came to nothing, and the state of tension was broken by President Kruger's ultimatum of Oct. 9, which precipitated war. With the outbreak of hostilities the region was denuded of its British population and the Boers continued their preparation for the defence of the city. Seven months afterwards (May 31, 1900), on the advance of the imperial forces under Lord Roberts through the Orange Free State, which had thrown in its lot with the neighboring Republic in the war, Johannesburg was captured and occupied by the British. See the BOER WAR, in these Supplements. See also the TRANSVAAL, Vol. XIII, p. 518. G. M. A.

JOHANNOT, a family of French artists. FRANCIS, a German merchant of French descent, and an amateur painter of flowers. In 1806 he tried to introduce lithography in Paris, but failed. For a time he was librarian at Mannheim.—CHARLES, his eldest son, was born at Offenbach, in Hesse-Darmstadt, in 1783; died in Paris in 1825. He was a promising engraver, but died early, on account of hard work.—CHARLES HENRI ALFRED, youngest son of Francis; born at Offenbach, March 21, 1800. He learned engraving under his brother, and attracted attention by his engravings, after Scheffer and Gerard. He illustrated editions of Cooper, Scott, and Byron, and at the time of death, in Paris, Dec. 7, 1837, was employed in decorating the chapel of Notre Dame de Lorette. Two of his pictures, *Mademoiselle de Montpensier* and *The Battle of Brattelen*, are at Versailles.—TONY, a brother of the two preceding, was born, also, at Offenbach, Nov. 9, 1803. He gave his

attention largely to book-illustrating, and in this excelled all others of his time. His illustration of a book insured its success. Among the authors whose works he illustrated are George Sand, Lamartine, Scott, Goethe, Rousseau, De Musset and Saint-Pierre. His most important work is considered to be the series of etchings illustrating Goethe's *Werther*. He died in Paris in 1852.

JOHN, EUGENIE, a German novelist writing under the *nom de plume* "E. Marlitt"; born at Arnstadt, Dec. 25, 1825. She was gifted with a fine voice, and in 1842 was sent, by the aid of the Princess Schwartzburg-Sundershausen, to Vienna to study music. She remained here three years and began to sing on the stage, but lost her voice. Thereafter, until 1863, she acted as reader to her former patroness, and then gave her entire attention to the writing of romances of a popular character. Among her works are *Goldelse* (1866); *The Old Mamsell's Secret* (1867); *Princess of the Moor* (1871); *Second Wife* (1873); and *At the Councillor's* (1877). Most of her books have been translated into English. She died June 22, 1887.

JOHN, JOHANN BAPTIST JOSEPH FABIAN SEBASTIAN, an Austrian archduke; born in Florence, Jan. 20, 1782, the sixth son of Emperor Leopold II and the Infanta Maria Louisa. He was thought, in his youth, to possess military talents, but while in command of the Austrian armies during the Napoleonic wars he was almost invariably defeated. He lived in retirement after the battle of Wagram, giving his attention to the study of natural science until 1848, when he was chosen regent of the Germanic empire by the Parliament of Frankfort. He was, however, too strong a partisan of Austria for such a position, and resigned Dec. 20, 1849. He died at Gratz, May 11, 1859.

JOHN, FREDERICK, "The Magnanimous." See SAXONY, Vol. XXI, p. 353.

JOHN, GEORGE I, Elector. See SAXONY, Vol. XXI, p. 354.

JOHN OF LEYDEN. See ANABAPTISTS, Vol. I, p. 787.

JOHNS HOPKINS UNIVERSITY, a non-sectarian institution of learning in Baltimore, Maryland, named after Johns Hopkins (q.v., in these Supplements), a merchant of Baltimore, by whose bequest it was founded. The university provides instruction for three classes of students. First, for undergraduates, those pursuing a regular collegiate course leading to the degree of bachelor of arts. The student is required to choose one of seven courses extending over a period of three years, and to confine his election of studies to the course chosen. This department was instituted largely for the convenience of young men living in and near Baltimore. Second, for those not candidates for a degree, who come to study or make investigation in some special line. Third, graduates either of the undergraduate department of the university or of some other college of recognized standing, who wish to pursue an advanced course of study leading to the degree of bachelor of philosophy. Here the latitude of election is greater than in the collegiate course, although the candidate must give evidence

of having done a certain prescribed amount of work. It was for this sort of work that the university was originally founded, the undergraduate department being forced upon it as an unpleasant necessity. The courses of study include instruction in Greek, Latin, Sanskrit, Semitic, Teutonic and Romance languages; philosophy, history, economics and pedagogics, mathematics, astronomy, physics, chemistry, biology, mineralogy, pathology, geology and morphology. The student is encouraged to carry on individual investigation, and clubs, semi-

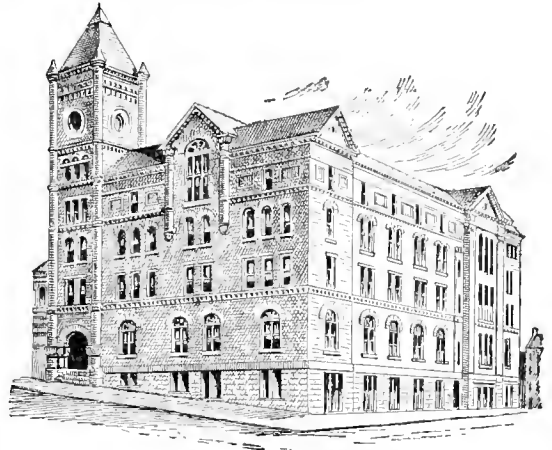

MC COY HALL, JOHNS HOPKINS UNIVERSITY.

naries and societies are organized for mutual assistance. Johns Hopkins University was the first among American universities to give preponderance to post-graduate work.

The university annually awards 21 fellowships of \$500 each; 20 scholarships to graduate students of \$200 each; 40 scholarships to undergraduate students from Maryland, varying in amount. The fellows are urged to teach in the university. Besides the regular courses of study, two lectureships have been founded,—the Percy Turnbull lectureship of poetry and the Levering lectureship on religious subjects. These are of a popular nature, and are open, by invitation, to the public. A prominent feature of the institution is the publication of journals devoted to particular branches of learning. These are *American Journal of Mathematics* and *American Journal of Philology*, quarterlies; *American Chemical Journal*, eight times a year; *Studies in Historical and Political Science*, monthly; and *Studies from the Biological Laboratory*; *Contributions to Asyriology*; *Modern Language Notes*; and *University Circulars*. There were, in 1896, 86 instructors connected with the institution, 589 students, and, up to 1896, 748 degrees had been conferred. The buildings are situated in the city of Baltimore, and include an administration building with recitation halls, given by John W. McCoy; a public hall, a library containing 70,000 volumes; a gymnasium; physical, chemical and biological laboratories; and a hall for the Young Men's Christian Association, given by Mr. Eugene Levering. Several of the departments are housed temporarily, awaiting the erection of more suitable buildings.

Mr. Hopkins announced his intention of founding

a university some time before his death, and selected its trustees from among his friends. The institution was incorporated in 1867, and in 1870 the trustees met, organized, and adjourned until after the death of the founder. This occurred in December, 1873. Another meeting was then called, the plan of the university laid out and Daniel C. Gilman elected its first president. In the fall of 1876 the department of philosophy was opened. The endowment of the university comprised Mr. Hopkins's country seat at Clifton and funds invested in Baltimore and Ohio railroad stock and other securities, amounting, in all, to over \$3,000,000. Mr. Hopkins strongly advised that the Baltimore and Ohio stock should not be sold, and, in consequence, in 1887, and for several years after, when the failure of this company caused a suspension of dividends, the trustees of the university were at first unable to procure revenue for running-expenses. However, over \$100,000 was subscribed as an emergency fund, which enabled the institution to pass through the difficulty. In 1890 a conversion of the stock was effected, and the financial future of the university assured. As yet the department of philosophy is the only one opened, but steps have been taken for the institution of a medical school, to be maintained in connection with the Johns Hopkins Hospital, which will be open to both sexes. Five hundred thousand dollars have been subscribed for this purpose, including \$350,000 from Mary Elizabeth Garrett of Baltimore.

**JOHNS ISLAND**, an island of Berkeley County, southeastern South Carolina, 6 miles S.W. of Charleston, a member of the Sea Island group. It is 16 miles long and 10 wide, and had, in 1890, a population of 2,016.

**JOHNSON**, a village in Lamoille County, northern Vermont, on the Lamoille River, and on the St. Johnsbury and Lake Champlain railway, 28 miles N. of Montpelier. It has lumber, flour and woolen industries. Population 1900, 1,391.

**JOHNSON, BARTON W.**, an American educator; born in Tazewell County, Illinois, in 1833. He was educated in Bethany College, West Virginia, and for a time after graduation was tutor there; was president of Eureka College, Illinois; later of Oska-loosa College, Iowa; served on the staff of the *Christian Evangelist* and the *Christian Quarterly*, both of St. Louis, Missouri; author of *Commentary on St. John; The People's New Testament; Young Folks in Bible Lands*. He died May 24, 1894, in De Leon, Texas.

**JOHNSON, BUSHROD RUST**, an American general; born in Belmont County, Ohio, Oct. 7, 1817. He graduated at West Point in 1840; served in the Seminole and Mexican wars, and became superintendent of the Western Military Institute of Kentucky. In 1861 he entered the Confederate service; was taken prisoner at Fort Donelson, but escaped soon after; commanded a division at Chattanooga; and was promoted major-general in 1864. He was afterward chancellor of the University of Nashville. He died Sept. 11, 1880, in Brighton, Illinois.

**JOHNSON, EASTMAN**, an American artist; born at Lovell, Maine, July 29, 1824. From the age of 17 he devoted himself to art-work; in 1849 went to

Düsseldorf, where he studied two years, and afterward resided for four years at The Hague, where, besides numerous portraits, he executed *The Saver-ard* and the *Card-Players*, his earliest pictures in oil. After visiting the principal European galleries, he established himself in Paris, but was soon after called home to Washington. In 1858 he settled at New York. In 1860 he was elected to the National Academy. His favorite subjects are American rural and domestic life, including the negro and other subjects, though in later years he devoted himself almost exclusively to portrait-painting. Among his works are *The Old Kentucky Home; Corn-Husking Bee; and The School of Philosophy at Nantucket*.

**JOHNSON, SIR GEORGE**, an English physician; born at Goudhurst, Kent, November, 1818; educated at King's College, London, from which he received his M.D. in 1844; was tutor in the college, and in 1857 became professor of materia medica; in 1863 professor of principles and practice of medicine; in 1876 professor of clinical medicine in King's College Hospital; in 1889 physician extraordinary to the Queen; and in 1892 was knighted. He wrote *On Diseases of the Kidney* (1852); *Lectures on Bright's Disease* (1873); *Medical Lectures and Essays* (1887). Died in London, June 3, 1896.

**JOHNSON, HERRICK**, an American Presbyterian minister; born in Fonda, New York, Sept. 21, 1832; graduated from Hamilton College (1857); at the Auburn Theological Seminary (1860). He held pastorates at Troy, New York (1860-62); in Pittsburg, Pennsylvania (1862-68); in Philadelphia (1868-74); in Chicago (1880-84). He was professor of sacred rhetoric and pastoral theology at the Auburn Theological Seminary (1874-80); professor of homiletics in the McCormick Theological Seminary in Chicago after 1880. He published *Christianity's Challenge* (1881); *Plain Talks About Theaters* (1883); *Forms for Special Occasions* (1889).

**JOHNSON, HERSCHEL VESPASIAN**, an American statesman and jurist; born in Burke County, Georgia, Sept. 18, 1812; graduated from the Georgia University in 1834, and practiced law in Augusta; in 1839 he moved to Jefferson County and gave his attention to politics; in 1848 was appointed to fill a vacancy in the United States Senate; was made circuit judge in 1849; governor of Georgia (1853-57); in 1860 was Vice-Presidential candidate with Stephen A. Douglas; opposed secession, but went with his state and became a member of the Confederate Senate; after the war, elected to the United States Senate, but was disqualified by his connection with the Rebellion. Upon the removal of disabilities, he was elected, in 1873, to the circuit bench. He died Aug. 16, 1880, in Jefferson County, Georgia.

**JOHNSON, ISAAC**, an English colonist in America; born at Clipsham, Rutlandshire. He emigrated to America with Winthrop and Endicott, June 12, 1630, to found a colony in a tract of land in Massachusetts, which, two years before, the Plymouth Company had granted them and others under the name of the Massachusetts Bay Company; they went first to Salem, but in a month removed to Charlestown, and there founded a colony and church. The church was afterward moved across to Boston



and became "The First Church of Boston." Johnson died a few months after his arrival, Sept. 30, 1830. His wife, Lady Arabella, a sister of the Earl of Lincoln, after whom Winthrop named his ship, died a month before her husband.

JOHNSON, JOHN B., an American engineer; born at Marlboro, Ohio, June 11, 1850; graduated at the University of Michigan (1878); government surveyor (1878-83); elected professor of civil-engineering in Washington University, St. Louis, Missouri, in 1883. He was the author of *Theory and Practice of Surveying* (1886); *Modern Framed Structures* (1892). For some years he was engaged in making government strength-tests of American timbers.

JOHNSON, OLIVER, an American editor; born in Peacham, Vermont, Dec. 27, 1809. He served an apprenticeship in the printing-office of the *Montpelier Watchman*, and in 1831 became editor of the *Christian Soldier*, a Universalist semimonthly of Boston. Here he met William Lloyd Garrison and became with him one of the founders of the New England Antislavery Society, the name of which was afterward changed to the American Antislavery Society. He edited until 1865 several antislavery journals, in succession, in Boston, New York, Philadelphia and the West, and after the Civil War became manager of the *Independent*; in 1870, of *The Weekly Tribune*; in 1873, of the *Christian Union*; in 1877, editor of the *Orange Journal*; in 1884 became a member of the staff of the New York *Evening Post*. He published *William Lloyd Garrison and His Times* (1880). He died in Brooklyn, Dec. 10, 1889.

JOHNSON, REVERDY, an American statesman; born in Annapolis, Maryland, May 21, 1796; graduated at St. John's College, studied law and was admitted to the bar in 1815, and began practice in Prince George County, Maryland. In 1817 he removed to Baltimore, and in 1821 became a member of the state senate; was elected to the United States Senate in 1845; was appointed Attorney-General in President Taylor's Cabinet in 1849; in 1863 elected again to the United States Senate. In 1868 he

went to England as minister, and while there negotiated the "Johnson-Clarendon" treaty, which was rejected by the Senate, although the question under discussion—that regarding the *Alabama* Claims—was eventually settled in very much the same way. On his return to the United States in 1869, he resumed the practice of law, which he continued to within a few days of his death, which occurred in Annapolis, Feb. 10, 1876.

JOHNSON, RICHARD MENTOR, an American statesman; born at Bryant Station, Kentucky, Oct. 17, 1780. He was educated at Transylvania University; admitted to the Kentucky bar, and from

1804 to 1807 was a member of the state legislature. He was elected to Congress in 1807, and served until 1819. At the beginning of the war of 1812 he raised a battalion of three companies, and commanded it in active service for ten months. Shortly afterward he raised a regiment of one thousand mounted volunteers, and was himself in command until the fall of 1813, when he was wounded several times, in the battle of the Thames, and compelled to give up his post. It was in this battle that he gained the name of "Tecumseh Killer." From 1819 to 1829 he was a United States Senator, and then was again a member of the House till 1837, when he was chosen Vice-President on the ticket with Martin Van Buren. He was afterward elected again to the state legislature of Kentucky, and was a member of that body at the time of his death. He died Nov. 19, 1850.

JOHNSON, RICHARD W., an American general; born near Smithland, Kentucky, Feb. 7, 1827; graduated from West Point in 1849; became first lieutenant of cavalry in 1855; captain, 1856; major, 1862; appointed brigadier-general of volunteers in 1861; served in Buell's army in Tennessee; given command of a division in the army of Ohio and later in the army of the Cumberland; served on the staff of Gen. G. H. Thomas. He retired in 1867 with the rank of brigadier-general. He was military professor in the University of Missouri, 1868-69; in the University of Minnesota, 1869-70. He was the author of a *Life of General George H. Thomas* (1881) and *A Soldier's Reminiscences in Peace and War* (1886). Died at St. Paul, Minn., April 21, 1897.

JOHNSON, ROSSITER, an American author and editor; born in Rochester, New York, Jan. 27, 1840; educated at the University of Rochester, graduating in 1863; edited, with Robert Carter, the *Rochester Democrat* (1864-68); editor of the *Concord* (New Hampshire) *Statesman* (1869-72). From 1873 to 1877 he was associated with Ripley and Dana in editing the *American Cyclopaedia*, and afterward, with Sydney Gay, in the preparation of the last two volumes of Bryant and Gay's *History of the United States*. In 1883 he became editor of the *Annual Cyclopaedia*. He edited, also, the series of *Little Classics* (1874-75 and 1880); collections of poems entitled *Famous Single and Fugitive Poems* (1877); *Play-Day Poems* (1878); and *Fifty Perfect Poems* (1882), the latter with Charles A. Dana. Among his own writings are *Phaeton Rogers* (1881); *A History of the War between the United States and Great Britain in 1812-15* (1882); *A History of the French War* (1882); *Idler and Poet* (1883); and *A Short History of the War of Secession* (1888).

JOHNSON, SAMUEL, an American clergyman and educator; born in Guilford, Connecticut, Oct. 14, 1696. He was educated at Yale College, which was then located at Saybrook, Connecticut, and when the institution was removed to New Haven, became a tutor, studying theology at the same time. In 1720 he was ordained minister in the Congregational Church and given a pastorate at West Haven. Later, he became converted to Episcopacy, and in 1722 went to England with two friends and was ordained priest. He returned and became pastor



REVERDY JOHNSON.

at Stratford, and during his pastorate was engaged in many theological discussions with "dissenting clergymen." He became acquainted with Dean Berkeley during the latter's residence in Newport, and induced him to make gifts to Yale. He also accepted Berkeley's system of philosophy, which he embodied in his own philosophical works. In 1754 he accepted the presidency of King's (now Columbia) College, which was just founded, and consisted of eight students, who recited in Trinity Church vestry-room. He labored for eight years to set the institution on a firm basis, resigned in 1763 on account of old age, and returned to his old parish at Stratford, where he remained till his death, Jan. 6, 1772. Among his works are *System of Morality*, afterward published under the title *Elementa Philosophica*, in Philadelphia, by Benjamin Franklin, and *An English and Hebrew Grammar*. His *Life* was written by the Rev. E. Edwards Beardsley (1874).

JOHNSON, SAMUEL WILLIAM, an American chemist; born in Kingsboro, New York, July 3, 1830; studied at the Yale (now Sheffield) Scientific School, and in Leipzig and Munich. In 1856 he was chosen professor of theoretical and agricultural chemistry at the Sheffield School. He published *Peat: Its Uses as a Fertilizer and Fuel* (1866); *How Crops Grow* (1868); *How Crops Feed* (1870); also translations of Fresenius's *Manuals of Qualitative and Quantitative Analysis* (1864 and 1869).

JOHNSON, SIR WILLIAM, an English colonist and general in America; born at Warrentown, County Down, Ireland, in 1715. He was intended for a mercantile career, but gave this up, and in 1738 went to America as the steward of a large tract of land on the Mohawk River, in what is now Montgomery and Fulton counties, which his uncle, Sir Peter Warren, had received as the dowry of his wife, Miss Delancy, of New York. Johnson settled on the river, about three miles west of Amsterdam, and began to promote the colonization of the tract and to trade with the Iroquois tribes in the neighborhood. In his transactions with the latter, he was remarkably successful. He was always just and honorable in his dealings with them, and, moreover, gave himself the trouble to become acquainted with their customs and to learn their language, and even at times assumed their dress, treating them always in a manner that was at once affable and dignified. As a result, he won completely their confidence and respect, and to such an extent that he was elected sachem by the Mohawk tribe. Realizing the value of such a man, Governor Clinton appointed him Indian commissioner for New York.

When the French and Indian war broke out, his services were still more valuable. He was now made superintendent of the affairs of the Six Nations, and given command of a force of 3,500 men, English colonists and Indians, with the rank of major-general. He moved northward to Lake St. Sacrement, which he named Lake George, and on Sept. 5, 1755, defeated General Dieskau and the French in the battle of Lake George, although, on account of a wound received by Johnson early in the fight, Phineas Lyman, who commanded the New England militia, had to bear the brunt of the

battle. Johnson, however, was given the credit for the victory, besides a baronetcy and £5,000. In the following year he was commissioned by the king sole superintendent of the affairs of the Six Nations, with a salary of £600. During the following two years he fought in the unsuccessful campaigns of Loudon and Abercrombie, and in 1759 was second in command in Prideaux's expedition against Fort Niagara. Upon the death of the latter, he took command of the entire force. On the 24th of July he defeated D'Aubry, who had attempted to relieve the fort, which was thereby forced to capitulate on the next day. For these services he received a royal patent for 100,000 acres north of the Mohawk River. Here he retired after the surrender of Canada to the English, founded the town of Johnstown, and lived until his death on his estates as a baronial landlord. He still retained his influence over the Indians, and used it to prevent hostilities between them and the whites. In 1768 he made a treaty with the Iroquois which established their frontier at the Alleghany and Ohio rivers, thus including Kentucky with Virginia. He died at Johnstown, New York, July 11, 1774. His *Life* has been written by W. L. Stone.

JOHNSON, WILLIAM SAMUEL, an American jurist; son of Dr. Samuel Johnson; born in Stratford, Connecticut, Oct. 7, 1727; was graduated from Yale in 1740, and was admitted to the bar in 1746; in 1761, and again in 1765, represented Stratford, Connecticut, in the general assembly. In the latter year he was chosen a member of the First Colonial Congress which met to consider the Stamp Act, and in 1766 was sent to the upper house, or governor's council of Connecticut; in 1772 became a judge of the superior court, but held office only a few months; from 1784 to 1787 was a member of the Continental Congress. When hostilities broke out between Great Britain and the colonies, he retired to Stratford, being unwilling to give his support to the latter. After peace had been concluded, he was placed at the head of the Connecticut delegation to the Constitutional Convention, and in 1789 became the first United States Senator from Connecticut. From 1787 to 1800 he was president of Columbia College, and after his resignation from this office, lived at Stratford until his death, Nov. 14, 1819. The Rev. E. Edwards Beardsley wrote his *Life* (1876).

JOHNSON CITY, a city of Washington County, eastern Tennessee, on the East Tennessee and Western North Carolina, the Ohio River and Charleston and the Southern railroads, 22 miles S. of Bristol. It has foundries, machine-shops and manufactories of leather, sashes and blinds and furniture. Population 1890, 4,161; 1900, 4,645.

JOHNSON-GRASS, a local name for *Sorghum halapense*, a grass of the Southern states. It grows luxuriantly, and is regarded as an obnoxious weed, although of some value as a forage-plant.

JOHNSTON, ALEXANDER, an American educator and historical writer; born in Brooklyn, New York, April 29, 1829; was graduated from Rutgers College in 1870; admitted to the bar of New Jersey in 1876; taught in the Rutgers Grammar School for three years, and in 1879 became principal of the

Latin School of Norwalk, Connecticut. In the same year he published his first historical work, *A History of American Politics*. In 1883 he was called to the chair of jurisprudence and political economy at Princeton, which he occupied until his death, July 21, 1889. Among his other works are, *The Genesis of a New England State* (1883); *Representative American Orations* (1884); *A History of the United States*, for schools (1885); *Connecticut*, in the American Commonwealth Series (1887); and *The United States: Its History and Constitution*. He was a contributor to Lalor's *Cyclopædia of Political Science*, and to Windsor's *Narrative and Critical History of the United States*.

JOHNSTON, ALEXANDER KEITH, a Scottish cartographer and geographer, son of Alexander Keith Johnston (q.v., Vol. XIII, p. 730); born in 1846; was educated as a draftsman in his father's firm, and afterward in the Institute of Gotha, under Dr Petermann. He took part in an exploring expedition to Paraguay in 1874, and in 1879 was appointed leader of the Royal Geographical Society's expedition to East Africa, mainly for the purpose of discovering a practical route to the interior. He was scarcely a month on the way when he fell a victim to dysentery at Berobero, between Dar-es-Salaam and Lake Nyasa, June 28, 1879. He was a frequent contributor to the *Geographical Magazine*; wrote a *Physical Geography* (1877); edited and extended Hellwald's *Africa*, in Stanford's Series (1879); and edited a sheet-map of Africa and Boyce's *Gazetteer* (1879).

JOHNSTON, SIR HARRY HAMILTON, an English traveler and author; born at Kennington, Surrey, June 12, 1858. He was educated at King's College; appointed vice-consul for the Cameroons and the Oil Rivers in 1885; consul for Portuguese East Africa in 1888; consul-general and commissioner for British Central Africa in 1891-97; consul-general in Tunis in 1897. He traveled in various parts of Africa; in 1884 conducted a party to Mount Kilimanjaro; and in 1887 surveyed a portion of the Niger delta. He is an artist, and studied and exhibited at the Royal Academy. He wrote *The River Congo* (1884); *The History of a Slave* (1889); *Life of Livingstone* (1891); and *British Central Africa* (1897).

JOHNSTON, JOSEPH ECCLESTON, an American soldier; born at Longwood, in Prince Edward County, Virginia, Feb. 3, 1807. He was graduated from the Military Academy at West Point in 1829, and served in the Seminole and Mexican wars and elsewhere, chiefly as topographical engineer. At the outbreak of the Civil War he was made quartermaster-general, with the rank of brigadier-general. He resigned his commission April 22, 1861, being the highest ranked officer to leave the Union army, and entered the Confederate service as major-general of volunteers. He was commissioned brigadier-gen-



GEN. JOSEPH E. JOHNSTON.

eral in the Confederate army two weeks later, and given command of a force in the Shenandoah valley against General Patterson. He evaded the latter, and reinforced Beauregard at Bull Run, July 21, 1861. He next took charge of the forces in the peninsula campaign of 1862, and was wounded severely at the battle of Fair Oaks, near Richmond, May 31st. In November, having been made lieutenant-general, he was assigned to the command of the military department of Tennessee, and in the following spring made an ineffectual effort to relieve Vicksburg, on the Mississippi, which was then besieged by General Grant. After the defeat of General Bragg at Chattanooga, Nov. 25, 1863, Johnston was assigned to the command of all the Confederate forces in the Southwest, with the rank of general. In 1864 he was at the head of the forces which opposed Sherman in his "march to the sea." Compelled to fall back from point to point, the authorities at Richmond became dissatisfied, and on July 17th, Johnston was ordered by President Davis to turn over his command to General Hood. Near the close of February, 1865, when Sherman had marched into South Carolina, Johnston, at the request of General Lee, was directed to assume the command of the remnant of the army of Tennessee, and of all the forces in South Carolina, Georgia and Florida, to "drive back Sherman." The force which he could concentrate was greatly inferior to that of Sherman, and he was unable seriously to check his march. Having learned that Lee had surrendered the army of Virginia to Grant, Johnston capitulated to Sherman at Durham's Station, North Carolina. From the close of the war until 1885 he was engaged in agricultural, commercial and railroad enterprises. In 1877 he was elected to Congress, and in March, 1885, he was appointed commissioner of railroads by President Cleveland. He published a *Narrative of Military Operations* (1874), and several articles in the *Century Magazine*. Johnston's career as a general in the Civil War was a series of failures and retreats, but he cannot be held as entirely responsible for them. As the highest ranked officer to leave the Union army, he should have been given, according to the law passed by the Confederate Senate, the highest rank in the Confederate army. Jefferson Davis, however, by dating his commission as general later than that of Cooper, A. S. Johnston or Lee, the first two of whom ranked as colonel, the last-named as lieutenant-colonel, made Johnston fourth in command. Johnston protested, but in vain, and thereafter he and the President were continually in conflict. In the campaign which ended with the fall of Vicksburg, his most disastrous one, Johnston claimed that he had urged a concentration of the forces on the Mississippi, and especially that Pemberton should not remain in Vicksburg. The latter, however, was allowed to hold his precarious position and Johnston's suggestions disregarded until it was too late. He died March 21, 1891.

JOHNSTON, RICHARD MALCOLM, an American author; born in Powelton, Hancock Co., Ga., March 8, 1812. He was graduated from Mercer University, Georgia, in 1841, and subsequently was admitted to the bar. He filled the chair of literature in

the University of Georgia until the outbreak of the Civil War, and then moved to his country home,



RICHARD M. JOHNSTON

near Sparta, Ga., and opened a boys' school. In 1867 he removed his school to Baltimore Co., Md. Besides contributions to periodicals, he wrote *Dukesborough Tales* (1871) *A History of English Literature*, in conjunction with W. H. Brown (1872) *Life of Alexander H. Stephens* (1878), *Old Mark Langston* (1884); *Two Gray Tourists* (1885), *Mr. Absalom Billingslea and Other*

*Georgia Folk* (1888), *Ogeechee Cross-Firings* (1889); *Studies, Literary and Social* (1891-92); *Mr. Billy Downs and His Likes* (1892), *Little Ike Templin* (1894); *Old Times in Middle Georgia* (1897); *Pearse Amerson's Will* (1898). Died in Baltimore, Md., Sept. 23, 1898.

JOHNSTON, MARY, American historical novelist, was born at Buchanan, Va., Nov. 21, 1870, and as she has always been delicate in health she was educated at home. Her childhood and youth were chiefly passed in Virginia, on the banks of the James River. In 1893, her family left West Virginia for New York, where our authoress became for a time practically an invalid. She read and studied assiduously, however, and in the winter of 1896 she wrote and subsequently published *The Prisoners of Hope*, and later on appeared *To Have and to Hold*. The success of both novels, in the United States as well as in England, has been phenomenal. Their plots, though slight, are strong and well conceived, and there is an especial charm in their descriptive scenes. Miss Johnston at present resides in Birmingham, Ala.

JOHNSTON, WILLIAM PRESTON, an American educator, son of Gen. A. S. Johnston; born in Louisville, Kentucky, Jan. 5, 1831. He was graduated from Yale in 1852, and at the Louisville Law School in 1853; served in the Confederate army, as colonel, on the staff of Jefferson Davis; professor of history and literature in Washington and Lee University (1867-77); president of Louisiana State University (1880-83); in 1884, on the foundation of Tulane University, in New Orleans, became its first president; in 1891, chosen regent of the Smithsonian Institution. He published *The Life of General Albert Sidney Johnston* (1878).

JOHNSTOWN, a city of Cambria County, southwestern central Pennsylvania, on the Baltimore and Ohio and the Pennsylvania railroads, at the confluence of the Little Conemaugh River and Stony Creek. The city was almost totally destroyed on May 31, 1889, by the bursting of a dam in the Conemaugh River (see CONEMAUGH FLOOD, in these Supplements). It recovered very rapidly from the effects of this calamity. It is a manufacturing city, having the Cambria Iron Works, which employ about six thousand men. It also has manufactories of wire, cement, fire-brick, leather and woolen goods. The capital invested in the larger

industries here aggregates \$13,300,000, and the value of their annual products averages \$18,400,000. Population 1890, 21,805; 1900, 35,936.

JOIGNEAUX, PIERRE, a French journalist and writer on agricultural subjects; born at Varennes, Côte-d'Or, Dec. 25, 1815. He was educated at the Central School of Arts and Manufactures, took part in the struggles against the government of Louis Philippe, editing secretly several radical papers, and was imprisoned, but afterward released. In 1848 he was elected to the Assembly as an ultra-Liberal, and after the *coup d'état* was banished to Belgium. He was allowed to return, and in 1869 was elected to the Chamber of Deputies; in 1871 was elected to the National Assembly; in 1876 was re-elected to the Chamber, sitting on the Left, and was re-elected thereafter until 1889; in that year he was chosen to the Senate. He founded and edited many journals, and published, among other works, *Dictionary of Practical Agriculture* (1855); *Counsels to the Young Farming-Woman* (1861); *New Letters to Farmers* (1871). He died Jan. 25, 1892.

JOINDER, in law, the uniting of two or more causes of action in one declaration. Thus one action may be maintained upon two notes by uniting a count upon each note in the same declaration. Causes of action cannot generally be joined except when they exist between the same parties, so that one judgment can be given covering all the causes of action. The practice of joining more than one cause of action in one suit is regulated, to some extent, by the statutes of the different states. Different offenses of the same general nature may frequently be joined in one indictment, but not when they constitute two distinct crimes. Joinder in pleading is the act of accepting an issue tendered by the pleading of the other party, whereupon the issue is said to be joined. The term is also used to denote the act of making the proper persons parties to a suit.

JOINT-FIRS, a name sometimes given to species of *Ephedra*, a genus of *Gnetaceæ*, which family is the only representative of one of the three living groups of Gymnosperms, the other two being Cycads and Conifers. *Ephedra* has the general appearance of a shrubby, straggly branching *Equisetum*, and is a desert genus, growing in the desert region of the Mediterranean and western Asia, and represented by several species in the arid regions of the western United States.

JOINT OWNERSHIP. See JOINT, Vol. XIII, p. 731.

JOINT-RUSH, a name sometimes given to species of *Equisetum*, one of the genera of fern-plants, and the sole living representative of one of the three great divisions of fern-plants (Pteridophytes), the other two being ferns proper and club-mosses. The species of *Equisetum* are more commonly known as horse-tails or scouring-rushes. The fact that the stem is made up of a series of easily separated "joints" has suggested the name joint-rush. They grow in bogs or damp ground.

JOINT TENANCY. See JOINT, Vol. XIII, p. 731.

JOINTURE, a joint estate limited to both husband and wife. To constitute a valid jointure, it

is necessary that it take effect immediately upon the husband's death. It must be created before marriage, and must be expressly in lieu of her whole dower. In such case it will bar any claim for dower. In the United States the term signifies a joint estate of the husband and wife. See also **JOINT**, Vol. XIII, p. 731.

**JOINVILLE, FRANÇOIS FERDINAND PHILIPPE LOUIS MARIE D'ORLÉANS, PRINCE DE**, a French soldier; born at Neuilly, Aug. 14, 1818, being the third son of King Louis Philippe. In 1836 he became a lieutenant in the French navy, and in 1840 he commanded the frigate which brought the remains of Napoleon I from St. Helena to France. In 1843 he married the daughter of Dom Pedro I, Emperor of Brazil. Being made rear-admiral in 1844, he commanded

the fleet which bombarded Tangiers. His father being driven from the throne in 1848, Prince de Joinville relinquished his command and went to England. Afterward he devoted himself to travel and study; removed to America in 1861, and accompanied General McClellan during his command of the army of the Potomac. After 1870 he lived in retirement in France, and published *L'Angleterre*; *Études sur la Marine*; *La Guerre d'Amérique*; and *Encore un Mot sur Sadowa*.

**JOKAI, MAURUS**, a Hungarian writer; born at Komorn, Feb. 19, 1825. He studied in Presburg, and was admitted to the bar, but never practiced. His first work, a drama, entitled *The Jew Boy*, was published when he was seventeen years old. Soon after he entered journalism, and when the Revolution broke out took part with the Nationalists. After the restoration of Austrian rule he continued his literary and journalistic work, and was elected to the Hungarian Chamber. In 1863 he established the *Fatherland*, in which many of his novels appeared, and is now editor-in-chief of the governmental organ, the *Nation*. He published 200 volumes, novels, dramas, short stories and historical works. Among his most celebrated novels are *A Hungarian Nabob*; *Sad Times*; *The Accursed Family*; *The Last Days of the Janissaries*; *The Romance of the Next Century*; *Black Diamonds*; and *Transylvania's Golden Age*. See also **HUNGARY**, Vol. XII, p. 379.

**JOKJOKARTA** OR **DJOKJOKARTA**, a town of Java, in lat. 7° 47' N., long. 100° 21' E., the capital of the presidency of the same name. It has many European settlers and institutions. Population 59,000.

**JOLIBA**, an African river. See **NIGER**, Vol. XVII, p. 496.

**JOLIET**, a city and the capital of Will County, northeastern Illinois. It is on the Atchison, Topeka and Santa Fé, the Chicago and Alton, the Chicago, Rock Island and Pacific, the Elgin, Joliet and Eastern

and the Michigan Central railroads. It contains many handsome stone buildings, several churches, chapels, schools, banks, a Catholic academy, a convent and a state prison. Joliet has extensive flour-mills, machine-shops, breweries, lime-kilns, brickyards, foundries, manufactories of boots and shoes, Corliss engines, agricultural tools, cigar factories, Bessemer-steel works and rolling-mills, wire mills, carriage-shops, marble-works and manufactories of builders' hardware, cooperage, farming implements, stoves, sashes, doors and blinds. The capital of industries reporting in the census of 1890 was \$9,000,000. Their annual product was \$12,000,000 worth of merchandise. The city has a public library with 10,000 volumes, water-works, electric street-railways and lights. At this place there are large quarries of excellent Silurian limestone, called Joliet limestone. Population 1890, 23,264; 1900, 29,353. See also **JOLIET**, Vol. XIII, pp. 735, 736.

**JOLIET, CHARLES**, a French author; born at St. Hippolyte-sur-le-Doubs, Aug. 8, 1832. He studied at the Collège de Chartres and the Lycée de Versailles, and until 1864 held different positions in the civil service. In the mean time he became a contributor to the newspapers and magazines of the day. In 1864 he began to devote his entire attention to literary production. Among his numerous works are *The Story of Two Young Married People* (1866); *Les Athéniennes*, poems (1866); *The Pseudonyms of the Day* (1867); *Patriotic Novels* (1871); *The Viscountess of Jussey* (1875); *Carmagnol* (1876); *Diane* (1878); *Curiosities of Letters, the Sciences and the Arts* (1884); *Incoherent Novels* (1887); and *Violette* (1890).

**JOLIET, LOUIS**, a Canadian explorer; born in Quebec, Sept. 21, 1645. He was educated at the Jesuit College of Quebec and went through the preliminaries leading to an entrance into the priesthood, but gave up this calling for that of explorer and trader. In 1672 Governor Frontenac and Talon made an effort to trace the course of the Mississippi River, which was then supposed to discharge itself into the Sea of California. Joliet was intrusted with this enterprise, for which he was provided with a canoe and an assistant. At a Jesuit mission the two were joined by Father Marquette and five others, and proceeded as far as Mackinaw, Dec. 8, 1672. Here they derived information from the Indians, which enabled them to make a rough outline map of their proposed route. The party then ascended the Fox River from Green Bay, crossed over and descended the Wisconsin River, and on June 17, 1673, entered the Mississippi. After visiting several Indian villages on its banks, they became assured that the river emptied its waters into the Gulf of Mexico, and began their return journey. They reached Lake Winnebago at the end of September, where they spent the winter at the mission of St. Francis Xavier, and in 1674 returned to Quebec. On the way Joliet lost his map and papers by the upsetting of his canoe in the Lachine rapids of the St. Lawrence River. He was thereafter made governor of the colony. About 1680 he was granted Anticosti Island, where he built a fort, which was destroyed by the British and his wife taken prisoner. Later



PRINCE DE JOINVILLE.

Joliet explored Labrador, and on April 30, 1697, was granted the seigniorship of Joliet, near Quebec. The honor of the earliest exploration of the Mississippi remains unsettled. Joliet, Marquette and La Salle each have their advocates. For a discussion of the claims of each, see Winsor's *Critical and Narrative History* (1884). He died in Canada, May, 1700.

JOLLIVET, PIERRE JULES, a French artist; born in Paris in 1803; studied architecture at first, but afterward turned his attention to painting; entered the School of Fine Arts in Paris, in 1822; in 1835 gained a medal of the first class; was decorated with the cross of the Legion of Honor in 1851. Among his works are eighteen plates in the *Musée de Madrid*, purchased by Ferdinand VII of Spain; *The Bull-Fight* and *Christ Healing the Sick*, paintings; an enamel for the Emperor of Russia, entitled the *Virgin and Child*, and a larger work of the same nature, in the Church of St. Vincent de Paul, in Paris. He died in 1871.

JOLLY, FRIEDRICH, a German writer on nervous diseases; born in Heidelberg, Nov. 24, 1844. He graduated from the University of Munich; held professorships at the universities of Strasburg (1873-90) and Berlin after 1890. He published *Hysteria and Hypochondria* and *On the Electrical Resistance of the Human Body*. He was editor of the *Magazine of Psychiatry and Nervous Diseases*.

JOLLYBALANCE. See BALANCE, Vol. III, p. 261.

JOLY, JOHN, an Irish scientist; born in Hollywood, Kings County, Ireland, in 1857; studied at the Rathmines School and at Trinity College, Dublin; was assistant lecturer in engineering and in experimental physics in Trinity College; and afterward professor of physics in Alexandra College, Dublin. He published numerous papers in the magazines of the English and Irish scientific societies; among them, *On Specific Heat of Minerals* and *A Speculation as to the Pre-material Condition of the Universe*.

JONATHAN, a Jewish warrior, the eldest son of Saul; born about 1095 B.C. He was a man of great strength and courage, and distinguished himself in the wars against the Philistines, and especially by attacking, with his armor-bearer, a garrison of Philistines, twenty of whom he killed and the rest routed. But he is best known for his friendship for David, which began when the latter slew the giant of Gath, and lasted, despite the quarrel between David and Saul, until Jonathan's death. Jonathan was killed, with his father, Saul, in the battle of Gilboa, 1056 B.C. David pronounced an elegy upon him (2 Sam. i, 19). See DAVID, Vol. VI, pp. 838, 839.

JONES, ANSON, an American statesman; born in Great Barrington, Massachusetts, Jan. 20, 1798. He began the practice of medicine in 1820, at Litchfield, Connecticut, and in 1833 settled in Brazoria County, Texas. During the war between Texas and Mexico, he was a surgeon in the Texan army, and in 1837 was chosen to the Texan Congress. From 1837 to 1839 he was minister to the United States government; in 1840 member of the Senate; from 1841 to 1844 Secretary of State; and from 1844 to its annexation to the United States was President of Texas. He strongly opposed annexation, and

after it was accomplished retired and engaged for the rest of his life in agriculture. He died Jan. 7, 1858.

JONES, CHARLES COLCOCK, an American lawyer and historian; born in Savannah, Ga., Oct. 28, 1831; graduated from Princeton in 1852, from Harvard Law School in 1855, admitted to the bar in Savannah in 1856. During the Civil War he served in the Confederate army and reached the rank of colonel of artillery. In 1866-76 he practiced law in New York city, and in 1876 returned to Georgia. He wrote *Indian Remains in Southern Georgia* (1859); *Ancient Tumult on the Savannah River* (1868); *Antiquities of the Southern Indians* (1873). *Dr. Seto's March Through Georgia* (1880); *History of Georgia* (1883); and *Negro Myths from the Georgia Coast* (1888), etc. Died in Augusta, Ga., July 19, 1893.

JONES, ERNEST CHARLES, an English lawyer, author and political leader; born in 1819, in Germany, where his father was equerry to the Duke of Cumberland. He was educated in Germany, and at 19 went to England; began the study of law and also contributed to the magazines. He was admitted to the bar in 1844, but in 1845 became interested in the Chartist movement, of which he was soon one of the leaders. He issued the *Labourer* and *Notes of the People*, and founded the *People's Paper*, which for eight years was the organ of the Chartists. In 1848 he was sentenced to two years' imprisonment for a seditious speech, and during his confinement wrote an epic, *The Revolt of Hindustan*, it is said with his own blood, on the fly-leaves of the prison prayer-book, pen, ink and paper being denied him. After his release he continued to be the leader of the Chartist organization until its dissolution, never accepting any reward for his service. Three days before his death he was elected to Parliament from Manchester. He made contributions both to political and general literature during his whole life. Among his works are *The Battle-Day* (1855); *The Emperor's Vigil* (1855); *The Maid of Warsaw* (1854); *The Lass and Lady* (1855); *A Tale of Faith and Chivalry* (1860); and *Democracy Vindicated* (1867). He died Jan. 26, 1869.

JONES, HENRY ARTHUR, an English playwright; born at Granborough, Buckinghamshire, Sept. 20, 1851. He received a common-school education, and at 13 began to earn his living. He devoted all his leisure to study and writing, and on Dec. 11, 1878, produced his first play, *Only Around the Corner*, which was acted in the Exeter Theatre. In the following year his comedy, *A Clerical Error*, was played in London. His first great success was *The Silver King*, produced by Wilson Barrett at the Princess Theatre in 1882. Its popularity was immediate and has lasted until the present day. After this he wrote several other successful melodramas; among them, *The Noble Vagabond*; *Heart of Hearts*; and in 1889 produced *The Middleman*, the first of a series of plays, picturing English social life of the present, which made his reputation as a dramatic writer. *The Middleman*, with E. S. Williard in the leading rôle, was immediately successful, and had a run of two hundred nights. In the following year appeared *Judah*, and in 1891 the *Dancing-Girl*. *The Tempter*, Mr. Jones's first drama in blank verse, was

played at the Haymarket in 1893. He also brought out *The Case of Rebellious Susan* (1894), which made a great hit, *The Triumph of the Philistines* (1895); *Michael and His Lost Angel* (1896); *The Liars* (1898), and *The Manœuvres of Jane* (1898); In 1895 he published *The Renaissance of the Drama*. Almost all his plays have been acted in America.

JONES, HUGH BOLTON, an American artist; born in Baltimore, Maryland, Oct. 20, 1848. He studied in Baltimore, and afterward in Europe, and in 1877 made a sketching tour in Brittany and Spain. Among his pictures are *Tangier*; *Return of the Cows*; *Brittany*; *October*; *On Herring Run*; *Baltimore*; *Summer on the Blue Ridge*; *The Poplars*; *The Wayside Pool*; and *The Ferry Inn*. His studio was in New York.

JONES, JACOB, an American naval officer; born near Smyrna, Delaware, in March, 1768. He studied medicine, began to practice, then became clerk in the Delaware supreme court, and April 10, 1799, entered the United States navy as midshipman; was made lieutenant in 1801, and was taken prisoner in the harbor of Tripoli while on the *Philadelphia*, remaining captive for 18 months; made commander in 1810, and given charge of the *Wasp*. On Oct. 18, 1812, war having been declared with England, he met the British brig *Frolic*, and captured her after a desperate encounter. The British ship *Poictiers*, an immensely superior vessel, came in sight two hours afterward and captured both ships and carried them to Bermuda. Jones was paroled and returned to the United States, where he was awarded a medal by Congress for his gallantry. The encounter between the *Wasp* and the *Frolic* was one of the first of the war, and did much to give Americans confidence in the American navy. Jones was made post-captain and given command of the *Macedonian*, in Decatur's squadron. Afterward he was governor of the Philadelphia Naval Asylum. He died in Philadelphia, Aug. 3, 1850.

JONES, JAMES KIMBROUGH, an American soldier and public man; born Sept. 29, 1839, in Marshall County, Mississippi. He was a Confederate soldier in the Civil War; commenced the practice of law in 1873, and became a member of the Arkansas state senate the same year. He was chosen to the Forty-seventh Congress, and was re-elected to the Forty-eighth and Forty-ninth. He was then elected to the United States Senate, and took his seat in 1885, and was re-elected in 1891.

JONES, JENKIN LLOYD, an American Unitarian pastor; born in Llandyssil, Cardiganshire, Wales, Nov. 14, 1843. He graduated from the Meadville (Pennsylvania) Theological School; became pastor of the Unitarian church at Janesville, Wisconsin, in 1874; after 1883 was pastor of All Souls' Church, Chicago; after 1880 edited the religious journal, *Unity*. He also published *A Chorus of Faith* (1894); and *The Seven Great Religions* and *The Faith that Makes Faithful*, with W. C. Gannett.

JONES, JOHN PERCIVAL, an American public man; born in 1830, in Hay, Brecknockshire, Wales. His parents moved to Ohio while he was an infant, and he attended the public schools of Cleveland. In the early part of the California excitement he went to

that state, and engaged in farming and mining in one of the inland counties, which he subsequently represented in both houses of the state assembly. In 1867 he went to Nevada, and afterward engaged in the development of the mineral resources of that state. In 1873 he was elected, as a Republican, to the United States Senate, and was thrice re-elected.

JONES, THOMAS RUPERT, a British scientist; born at Cheapside, London, Oct. 1, 1819. Apprenticed to a surgeon in Taunton, Somersetshire, in 1835; in 1850 assistant secretary to the London Geological Society; lecturer in 1858, and in 1862 professor at the Royal Military College at Sandhurst; later, professor at the staff college. In 1875 he was the editor of the *Arctic Manual*; edited Dixon's *Geology of Sussex* contributed to the *Cyclopaedia of Anatomy*, Cassell's *Natural History* and the *Encyclopaedic Dictionary*; joint author of the *Nomenclature of the Foraminifera* (1859-72) and the *Micrographical Dictionary* (1874).

JONES, WILLIAM BASIL, a British ecclesiast, born in Cardiganshire, Wales, Jan. 2, 1822, educated at Trinity College, Oxford; held fellowships at Queen's and University colleges; tutor in University College in 1854, vicar of Bishopthorpe in 1865; archdeacon of York in 1867; bishop of St. David's in 1874. He was the author of *Vestiges of Gael in Gwynedd* (1851); *The History and Antiquities of St. David's* (1856); with E. A. Freeman, *Notes on the Edipus Tyrannus of Sophocles* (1862); with Archdeacon Churton, *Commentary on the New Testament* (1864). Died in Lampeter, Jan. 14, 1897.

JONESBORO, a town and the capital of Craighead County, northeastern Arkansas, on the Kansas City, Fort Scott and Memphis, the St. Louis, Iron Mountain and Southern and the St. Louis Southwestern railroads, 62 miles N.E. of Memphis, Tennessee. The chief products of the vicinity are cotton, corn and tobacco. It has saw and planing mills, cotton-gins, and stave, box and wagon factories. Population 1890, 2,065; 1900, 4,508.

JONESBORO, a city and the capital of Union County, southern Illinois, celebrated for the fine fruit grown in the region. It is on the Mobile and Ohio railroad, 30 miles N. of Cairo. It has good building-stone, a state insane asylum, mills and factories. Population 1900, 1,130.

JONESBORO, a village and the capital of Washington County, Tennessee, 100 miles N.E. of Knoxville. It is beautifully situated on the Southern railroad, seven miles W. of Johnson City. It is the oldest town in the state, was the first capital, contains an academy for girls, a normal institute, a foundry, tannery and a saw-mill. Population 1890, 937; 1900, 354.

JONESVILLE, a village of Hillsdale County, central southern Michigan, on the Lake Shore and Michigan Southern railroad, 25 miles S. of Jackson. It is in a fruit-growing region, and has large fruit- evaporators and cider-mills. Carriages, harness, staves, flour and machinery are manufactured. Population 1900, 1,367.

JONGKIND, JOHAN BARTHOLD, a Dutch painter and etcher; born at Latrope in 1819. He left his home in his youth, and went to study art in Paris,

under Isabej. He made his *début* in the Paris Salon of 1845. Among his paintings are *View of the Port of Harfleur* (1850); *The Meuse at Dordrecht* (1869); *The Interior of the Harbor of Dordrecht* (1870.) Perhaps he is better known as an etcher. His etchings are mostly of landscapes, and are made in a very rapid, sketchy manner directly upon the copper, but have great freshness and vigor. Among his best are *The Town of Maaslin, Holland* (1862); and *View of the Scheldt at Antwerp—Setting-sun* (1869). He died in Paris, Feb. 11, 1891.

JONGLEURS. See DRAMA, Vol. VII, p. 413.

JONQUIL, a plant. See *Narcissus*, under HORTICULTURE, Vol. XII, p. 257.

JONSSON, FINN. See ICELAND, Vol. XII, p. 626.

JOOST VAN DER VONDEL. See DRAMA, Vol. VII, p. 444.

JOPLIN, a city and railroad center of Jasper County, southwestern Missouri, about fourteen miles S.W. of the town of Carthage, on the Missouri Pacific, the Kansas City, Fort Scott and Memphis, the Kansas City, Pittsburg and Gulf and the St. Louis and San Francisco railroads. It has come into prominence in recent years as a center of commerce for the extensive lead and zinc mining region of the southwestern part of the state, in which it is located. Its annual output in zinc ores averages \$1,500,000; that of the district, \$4,000,000. It has boiler-works, foundries, machine-shops, a soap factory, etc. Population 1890, 9,943; since then it has annexed the mining suburbs, which raised the population in 1900 to 26,023.

JORDAN, a village of Onondaga County, west-central New York, on the West Shore and the New York Central and Hudson River railroads, and on the Erie canal, 15 miles W. of Syracuse. It has manufacturing of flour, furniture, wheelbarrows, sleds, furnaces, strawboards and machinery, and is the seat of an academy. Population 1900, 1,118.

JORDAN, a river of Utah, connecting Utah Lake with the Great Salt Lake. It is used extensively for irrigation purposes. In 1892, 22,000 acres of land were watered by canals from this river. Its direction is due north, and it is 40 miles long. Salt Lake City is situated on this river.

JORDAN, DAVID STARR, an American naturalist and educator; born in Gainesville, New York, Jan. 19, 1851. He graduated at Cornell University in 1872, and at the Indiana Medical College in 1875; taught at Lombard University (1872-73); Appleton (Wisconsin) Collegiate Institute (1873-74); at the Anderson School, at Penikese Island, Massachusetts (1874); in the Indianapolis High School (1874-75); professor of biology, Butler University (1875-79); professor of zoölogy, Indiana University (1879-85); president of Indiana University (1885-91); of Leland Stanford Junior University (1891). He published *Manual of the Vertebrates of the Northern United States* (1876), and over 250 papers, largely upon the ichthyology of the United States.

JORDAN, THOMAS, an American general; born in Luray Valley, Virginia, Sept. 30, 1819. He entered the United States infantry service in 1840,

and served in the war against the Semmole Indians, and later in the war with Mexico. At the outbreak of the Civil War he resigned his commission and entered the Confederate army as adjutant-general of the forces around Manassas, and afterward became chief of staff to General Beauregard; was promoted to the rank of brigadier-general after Shiloh; in 1866 was editor of the *Memphis Appeal*, and in 1869 became chief of staff to the revolutionary army in Cuba; the same year succeeded to the chief command, but a little later resigned because of the fruitlessness of the attempt. Upon his return he became editor of the *Financial and Mining Record*. With J. B. Pryor, he published *The Campaigns of Lieutenant-General Forrest* (1868). He died in New York, Nov. 27, 1895.

JORDAN, WILHELM, a German philosopher and poet; born in Insterburg, Prussia, Feb. 8, 1819; studied philosophy and theology at Königsberg; lived in Leipsic until exiled from Saxony on the charge of atheism and political radicalism; went to Bremen, and in 1848 was elected deputy to the assembly of Frankfort, sitting on the Left; afterward lived in retirement in the same city. Among his earlier works are *History of the Island of Haiti* (1846-49); *Bells and Canons*, a collection of poems inspired by liberal political opinions and by the philosophy of Hegel (1842); and *Popular Songs and Legends of Lithuania* (1844). Later, he wrote a philosophical epic, *Demiourgos* (1852); and the epic, *Nibelunge* (1877), in which he attempted, with no great success, an imitation of ancient German poetry; also the comedies, *Without Love* (1855); and *The False Prince* (1856). He translated the works of Homer, Sophocles and several of the plays of Shakespeare.

JORIS, DAVID GEORGE. See DAVIDISTS, Vol. VI, p. 844.

JORULIO, a volcano of the state of Michicoacan, Mexico. See GEOLOGY, Vol. X, p. 248.

JOSEFFY, RAFAEL, a Hungarian pianist and composer; born in Presburg in 1852; displayed juvenile precocity in music; pupil of Liszt's *protégé*, Carl Tausig, in Berlin; gave concerts in Germany that won instant applause for his technique and sympathetic playing; first visited the United States in 1895; composed a number of pieces for the piano.

JOSEPH, FRANÇOIS LE CLERC DU TREMBLAY, secretary of Cardinal Richelieu (1577-1638). See FRANCE, Vol. IX, pp. 568-570.

JOUBERT, GENERAL PÉTRUS JACOBUS, late commander of the Boer forces in the Transvaal in the war with Great Britain, was born at Cango, Cape Colony, in 1833. In 1867 he was state attorney for the Transvaal, has acted as president during Paul Kruger's absence in Europe, and on two occasions has himself been an unsuccessful candidate for the high office. In his military career, he first distinguished himself by the defeat, in 1881, of Sir George Colley at Majuba Hill, and in 1896 he was the chief factor in causing the surrender of Dr. Jameson, leader of the famous raid. In the field he was known to be an able tactician, though acting generally on the defensive. In the fall and winter of 1899 he operated chiefly in Natal,



and became an adept in ambuscading British troops. It was the Boer troops under his command that besieged Ladysmith and repulsed General Buller at Chieveley. In Mar. 27, 1900, General Joubert died at Pretoria from peritonitis and was succeeded in the supreme command in the field by General Louis Botha. Though opposed to British domination in South Africa, Joubert was known to favor a liberal policy towards the British.

**JOUBERT, BARTHÉLEMY CATHERINE**, a French general; born at Pont de Vaux, Bresse, April 14, 1769. He studied for the law, but on the outbreak of the revolution enlisted in the National Guard; was made sergeant in 1791, adjutant-general in 1794, and general of a brigade in the following year. In 1797 he drove the Austrians from Mantua, and subdued the Tyrol; and when the peace of Campo Formio was concluded, Napoleon sent him to Paris with the trophies of the campaign. He was made general-in-chief of the Army of Italy, in 1798 conquered Piedmont, and in Turin captured a vast amount of military supplies. In the following year he resigned his command, when the Directory instigated investigations of the conduct of some of the generals, denying the right of civil interference in military matters. The defeat of his successor, Moreau, led to his recall; but he was killed in a charge against his opponent, General Suwaroff, at Novi, Aug. 15, 1799.

**JOUBERT, JOSEPH**. See FRANCE, Vol. IX, p. 677.

**JOUFFROY, D'ARBANS, CLAUDE, MARQUIS DE**, a French mechanic; born in Franche-Comté, Sept. 30, 1751. In early manhood he served in the army, and while in Provence studied the navigation of sailing-vessels. The application of steam to navigation was suggested to him by the sight of a fire-engine, and in Provence, in 1783, while serving in the army, succeeded in making a small paddle-wheel steamboat sail up the Rhone, at Lyons. The vessel was, however, too defective to be available for purposes of actual navigation, and a patent was refused by the French government. Compelled by the Revolution to emigrate, he failed, on account of financial ruin, to float a company, till after Fulton had made his successful experiments on the Seine in 1803. In 1816, having obtained a patent, Jouffroy formed a company, and in the same year launched a steamer on the Seine, but he was unable to compete with other enterprises of the same kind. The French Academy in 1840 indorsed his claim to the discovery of steam navigation. He died of cholera, in Paris, 1832.

**JOULE, JAMES PRESCOTT**, an English physicist; born at Salford, England, Dec. 24, 1818. In his youth he had the good fortune to have for instructor in science the celebrated Dalton, and he soon showed, by constructing for himself electrical machines and other philosophical instruments, the bent of his genius. His earliest notable experiments were made with reference to electromagnetic engines, from which he passed to quantitative determinations regarding heat, and the transformation of various forms of energy. His investigations resulted in an important communication to the Royal Society *On the Change of Temperature Produced by Rarefaction and Condensation of Air*. With Professor Thom-

son (now Lord Kelvin) he carried on valuable investigations upon the thermal effects of fluids in motion, besides doing much work in several branches of physics, and is justly entitled to be considered as the experimental founder of the modern theory of conservation of energy—the grandest generalization ever made in physical science. Two volumes of his collected papers have been published by the Physical Society of London (1884–87). The universities of Dublin and Edinburgh conferred upon him the degree of LL.D., and the University of Oxford gave him the degree of D.C.L. He also received many marks of honor from abroad; and in 1878 a civil-list pension of £200 was conferred upon him. He died Oct. 11, 1889, at Sale, near Manchester. For discussions of his theories, see ELECTRICITY, Vol. VIII, pp. 15, 90 et seq.

**JOURDAN, JEAN BAPTISTE, COMTE**, a French marshal; born at Limoges, April 29, 1762. He entered the army at the age of 16; served five campaigns under Count d'Estaing in America, returning to France in 1784, when he engaged in business in Limoges. In 1792 he again joined the army, and soon rose to be chief in command of the Army of the North. He succeeded in driving the Austrians out of Maubeuge, but the Committee of Safety, not recognizing his worth, placed him on the retired list in 1793. He was recalled in 1794, and, being placed in command of the Army of the Sambre and Meuse, gained several important victories, but was defeated himself by the Archduke Charles. Resigning his command, he became a member of the Council of Five Hundred, being elected its president in 1798. When Napoleon rose to power, Jourdan would not sanction his revolutionary measures; so there always existed a coolness between them. But he was adviser to Joseph Bonaparte in Naples, and later in Spain. When Louis XVIII was restored he was created a peer, and although he took part under Napoleon on his return, held office again under the King. During the revolution of 1830 he was Minister of Foreign Affairs, but later governor of the Hôtel des Invalides. He died Nov. 23, 1833.

**JOURNALISM**. See NEWSPAPERS, Vol. XVII, pp. 412–437; and in these Supplements.

**JOUST**. See TOURNAMENTS, Vol. XXIII, p. 489.

**JOWETT, BENJAMIN**, an English classical scholar; born at Camberwell, near London in 1817. After being educated at Oxford he became a tutor in 1842, and in the same year he was ordained as a clergyman. He served afterward as an examiner of classical schools and for the Indian civil service. In 1855 he was appointed regius professor of Greek, in 1870 master of Balliol College, and in 1886 vice-chancellor of the University. His most important published works are *Commentary on the Epistles of St. Paul to the Thes-*



BENJAMIN JOWETT.

*salonians, Galatians and Romans: The Dialogues of Plato*, translated into English, with analyses and introductions (1871); and his translations of *Thucydides* and *Aristotle*. The degree of Hon. LL.D. was conferred on him by Cambridge in 1890. He died in Oxford, Oct. 1, 1893.

**JOWF.** Two oases in the north and southeast of Arabia. See ARABIA, Vol. II, pp. 254, 255.

**JOYCE, ISAAC W.**, an American Methodist Episcopal bishop; born in Hamilton County, Ohio, Oct. 11, 1836. At the age of 11 he went to Tippecanoe County, Indiana. He was educated at Hartsville University, and entered the ministry in 1859, serving until 1888. He was for four years a presiding elder, took part in the general conference of 1880, and again in 1888, when he was chosen bishop.

"J. S. OF DALE." See STIMSON, F. J., in these Supplements.

**JUAN DE FUCA, STRAIT OF.** See WASHINGTON, Vol. XXIV, p. 387; and FUCA, in these Supplements.

**JUBILEES, BOOK OF.** See APOCALYPTIC LITERATURE, Vol. II, pp. 176, 177.

**JUAN Y SANTACILIA**, a Spanish navigator; born near Alicante, Jan. 5, 1713. At the age of 21 he crossed the Atlantic and explored part of the American coast. He did much astronomical work, and was made a vice-admiral by Philip V in 1735. In connection with Ulloa, he was sent to the equator to measure a meridian arc, the results of which he published in 1748; followed this soon after with a treatise on the boundary between Spain and Portugal; was appointed commander of marine guards and inspector of harbors in 1753; published a treatise on ship-building (1761) and one on the state of astronomy (1773). His *Compendium of Navigation* appears under NAVIGATION, Vol. XVII, p. 250. He died in Madrid, June 21, 1773.

**JUAREZ**, formerly known as EL PASO DEL NORTE. A town of the state of Chihuahua, Mexico opposite El Paso, Texas. Its name originating from a pass used for many years by travelers. It is situated in northern Mexico, 280 miles S. S. W. of Santa Fé, and 215 miles N. of the city of Chihuahua, on the Rio Grande River, and on the Mexican Central railroad. The town is composed of a number of settlements, situated in a rich but narrow valley extending about ten miles along the right bank of the river; viticulture is a prominent industry of the locality, and large quantities of well-flavored wines and brandies are made, which are known to the traders as Pass wine and Pass brandy. The inhabitants are nearly all tinged with Indian blood. El Paso del Norte is the principal thoroughfare between New Mexico and the states of Chihuahua, Coahuila and Sonora. Population, about 8,000.

**JUCH, EMMA**, an American opera-singer; born in Vienna, of naturalized American parents, July 4, 1861. Attention was attracted to her strong soprano voice at an early age, and she studied for the operatic stage under Mme. Murio-Celli. She began her career by singing in concert under the management of her father and others. She at-

tracted the attention of Theodore Thomas during one of her tours, and by him she was engaged for one of his concert tours, and afterward for the Wagner festival concerts of 1884. In 1884 and 1885 was a member of Mapleson's Italian Opera Company, singing secondary *roles* under Patti and others; leading soprano of the American Opera Company in 1886; and afterward organized the Emma Juch Opera Company.

\***JUDAISM AND THE JEWS IN THE UNITED STATES**—*Number.* Data are lacking to compute reliably the exact number of Jews in the United States. Owing to the peculiar character of Judaism and its organization in this country, no records are officially kept, and therefore available, from which the Jewish population of the United States might be determined accurately. It is, however, more than probable that at the present moment there are upward of a million Jews in this country. In 1880 an attempt was made, under the auspices of the Union of American Hebrew Congregations, to arrive at the exact figures. From the information then collected—which, however, was anything but complete—the number of Jewish inhabitants was estimated to be in the neighborhood of three hundred thousand. Since then the immigration of Russian Jewish refugees has landed from four to five hundred thousand more on these shores. This, with the natural increase during the 15 years elapsed since the attempted census, would make the million-mark probably a little below the true figures. The greater majority of the Jews are settled in the large cities; New York with upward of three hundred thousand, Chicago with sixty or seventy thousand, Philadelphia with fifty thousand, Baltimore, Boston, Louisville, Cleveland, San Francisco, Buffalo, Cincinnati and New Orleans with from ten to fifteen thousand each, having the bulk, and the smaller towns in New York, Pennsylvania, Ohio, Illinois and other states fully representing two hundred thousand more, it is clear that the Jewish population, on the whole, may be said to be urban. In rural districts Jews are settled in single families and smaller groups, and one is safe to believe that in the central and Western sections there is perhaps no county in which Jews are not located.

*History.* Jews had settled in America before the Revolution. In Newport, Rhode Island, as well as in New York, there existed, in colonial days, organized Jewish congregations, while in Philadelphia, in Savannah, and other Southern parts, a goodly number of families had founded their homes, whose members were among the most active and respected merchants of their respective towns. These were, almost without exception, descendants of Spanish Jews, the so-called Sephardim. They had drifted to the colonial ports from the West Indies, though direct immigration from the European continent (Holland more especially) also had furnished its quota of these early Jewish pioneers. After the War of independence and the establishment of the constitutional government, the character of the Jew-

ish population, or its location, for many decades did not materially change, nor did the number increase. Though the constitution of the United States guaranteed full liberty of conscience, in some of the states, Maryland and Rhode Island for instance, religious tests required by law operated to the disadvantage, politically, if not otherwise, of the Jews, and it was only after a long and protracted struggle that these disabilities were removed finally from the statute books, and became inoperative. The second period in the history of the Jews in this country may be said to begin about 1835, and to extend to 1880. It may be characterized as that of the advent of the German Jews. The unbearable oppression, by law and governmental administration, under which the Jews in Germany suffered induced, in the fourth and fifth decades of the century, the younger men, and shortly afterward the younger women, among the Bavarian Jews and others to seek a new home and a larger opportunity in the freer fields of America. At first, a few sturdy pioneers ventured on the experiments, and as they succeeded, others took courage to follow their example, and during the fifth and sixth decades the movement had assumed such proportions that in many former centers of Jewish population in Bavaria none remained except the old and feeble, and these, for the most part, were supported in comparative ease by remittances from their children in America.

It was during these years (1835-60) that the more prominent congregations were called into existence along the Atlantic border, as well as in the new towns along the Ohio, Missouri and Mississippi, or by the lakes. The immigration of German Jews, in contradistinction to the Spanish element so designated (Ashkenazim), has continued to the present day, though since 1880 its importance, for the character and development of Judaism, has dwindled almost to insignificance, in comparison with the influx of the Jews from the dominion of the Czar. In 1882 this "tidal wave of misery," this involuntary immigration, first struck our shores, and, with slightly varying intensity, has kept up, landing in the midst of us men, women and children, who, could they have consulted their own wishes, would never have dreamed of leaving Russia, their native land. As it is, no country of Europe but has contributed to a greater or smaller extent to the Jewish population of the United States. The German immigration embraced natives of Holland, France and England, no less than of Germany, Austria and Hungary, and even Poland. By Russian Jews, however, although belonging, also, to the class of the Ashkenazim as distinguished from the Sephardim, as a technical term, are denoted the unfortunate victims of the policy of persecution inaugurated by Alexander III, Czar of all the Russias. It goes without saying, that a new type of Jews is developing rapidly in the United States, which, for good reason, may be said to be distinct from the three so far mentioned, though their combined product as such has the right to

its own name, the American Jew. The Sephardic Jew of the colonial days has disappeared almost entirely. A few congregations, steadily declining in the number of their membership, alone hold together those of their descendants who have not been absorbed in consequence of intermarriage and conversion by Christianity. The German Jew it was who has impressed his stamp upon the synagogue of America, and decided its policy as well as the social proclivities of its members. But now, by death, he is disappearing gradually before his own son and grandson, the American Jew; while, on the other hand, the massed influx of Russian Jews has been attended with peculiar difficulties and produced new problems, the effect of which upon the Jew and Judaism in America at this moment is withdrawn from all calculations.

*Religious Condition.* The Jews of America, as far as they belong to congregations, are divided into three parties: the Orthodox, the Conservative, and the Radical or Reformed. As state and church are divorced absolutely in the United States, membership in congregations is entirely voluntary. With the exception of the Russian Jews, among whom the very reverse is the case, not more than one half of the (non-Russian) Jews in America are members of congregations. In the smaller country towns the lack of numbers sufficient to support a religious establishment accounts for this circumstance. In the large cities the proportion of those who affiliate with congregations and contribute towards their maintenance, to those that do not, is about one to two, while in the medium-sized cities social pressure is, as a rule, such that almost every Jewish householder is induced to join the local congregational institutions. The polity of the Jewish religious organizations in the United States is strictly congregational; that is to say, every congregation is absolutely autonomous, regulating both its fiscal and religious affairs as best it seems to its members. There is no central religious authority, either synod or conference, or general assembly, exercising control over the individual congregations or their members. The congregations are chartered institutions under the laws of the respective states. At their head generally is a board of directors or trustees, with a president and the other customary executive officers, elected by the members in general meeting for a term of years in accordance with their constitution and by-laws. This board of directors has charge of the financial affairs of the society; the religious matters are in the hands of a rabbi, who is amenable to no higher ecclesiastical body, but is to a certain extent under the control of his board of trustees and his own members. The rabbi, by virtue of his office, has no ecclesiastical power. His influence with his people depends upon his scholarship and ability; it is altogether of a moral kind. In older congregations, the settlement of the rabbi was made for life; in recent years, the practice has become general to elect the rabbi only for a stated term of years. These terms vary in the different

congregations. While in some the rule is to fix the term at ten years, in others the habit has been to have annual elections; on the whole, however, contracts between rabbi and congregations are drawn to cover a five-years' service. The rabbi is expected to have received a thorough education both in Hebrew theology and in the academic branches taught in a good university. As a rule, this requirement is more than fulfilled, though if the congregations should choose to forego any or all of the usual attainments of an aspirant to rabbinical dignity, there is no authority to prevent the execution of their desire, or annul the election to office of a man not properly prepared.

Various attempts have been made to bring about a closer union between the different congregations for the purposes of co-operation in matters vital to all. The earliest movement in this direction resulted, in 1857, during the excitement created by the Mortara affair, in the creation of a board of delegates, chosen by the congregations, to take cognizance of cases of persecution and to enlist the good offices of the United States government in behalf of the oppressed Jews; furthermore, to see to it that the United States government refuse to make treaties with other powers that insisted upon placing the American citizens of the Jewish faith upon a level other and lower than that accorded the citizen of the Christian or no religion (Russia for instance). This board of delegates accomplished but little; it was largely recruited from the ranks of the Orthodox and Conservative, and was looked upon with suspicion by the Reform wing. It was merged, in 1878, into the Union of Hebrew Congregations. This was a creation originally of the Western and Southern Reform congregations, under the leadership of the Cincinnati rabbis, I. M. Wise and Max Lillenthal. It was formed in 1872, and from the start had to meet the opposition of the Orthodox, and the distrust, more or less well justified, of the larger Reform congregations and their rabbis in New York, Philadelphia, Chicago and elsewhere. But in 1878 this reluctance to enter into the Union, on the part of the Eastern societies, was to a large extent overcome, and in 1896 the Union counted 125 congregations, representing every state of the Union. Most of the Reform congregations are members, though not all; the Conservative and Orthodox have kept aloof. The object of the Union, which disclaims any intention to interfere with the autonomy of the component congregations, is to bring about a heartier co-operation for the common good. The central seat of the Union is at Cincinnati. Practically, the Union has accomplished only the founding and maintaining of the Hebrew Union College (1875) in Cincinnati, for the purpose of training rabbis. Officially, the college claims to belong to no religious party, but as the majority of the graduates (since 1883, when the first class of four American rabbis was graduated) have been of the Reform school, the college is looked upon with distrust by the Orthodox, who, to counteract the

growing influence of the Cincinnati men, founded in the city of New York in 1887 the Jewish Theological Seminary. Besides these two seminaries, the University of Chicago and Columbia College, and recently the Johns Hopkins University at Baltimore, in organizing rabbinical departments, have offered facilities for students preparing for the Jewish ministry. Before 1883, almost all the pulpits were filled by foreigners or Americans who had pursued their theological studies at European rabbinical seminaries and universities.

Nor have the attempts been wanting to bring the rabbis into closer touch with each other. In 1877, the Rabbinical Literary Association was founded, but after a precarious existence of only a few years, it died with the death of its founder, Dr. M. Lillenthal. The Ministers' Association, which was the creation of Dr. G. Gottheil of New York, shared the fate of its predecessor. But, in 1891, Dr. I. M. Wise, rabbi of Cincinnati, and president of the Hebrew Union College, with better success called into existence the Central Conference of American Rabbis. This is no legislative body. It is deliberative. One of its results is the preparation of the *Union Prayer-Book*, intended to unify the ritual of the various (Reform) congregations. The conference counts 105 rabbis as members, and its prayer-book has been adopted by seventy congregations. In some cities, New York and Chicago for instance, the local rabbis have formed among themselves rabbinical associations for study and counsel.

The words Orthodox, Conservative, Reform and Radical, in conjunction with Jewish belief, have a somewhat different bearing than in their usual acceptation. The pivotal point of difference between these schools is the problem of the destiny of the Jews. The Orthodox maintain that the Jews will ultimately return to Palestine, and become, under the rule of a personal Messiah of the house of David, again a priestly theocracy, with the Pentateuch as its constitution. Hence they insist upon maintaining all barriers between the Jew and the non-Jew, observing strictly the ritualism and Orientalism of the rabbinical codes,—the "revealed law," as contained in the Pentateuch and the Talmud; they pray in Hebrew exclusively, and regulate, without compromise, their life by the "law of God," the Bible and the rabbinical writings. Most of the Russian Jews belong to this school, as do, also, at least in theory, the few Spanish synagogues still in existence. The other schools reject the belief in the Palestinian destiny of Judaism. In accordance with the position taken by the German rabbis fifty years ago, they hold that Judaism is ethical monotheism, for the exemplifying of which Israel was called, and in the wisdom of Providence sent out into the world to teach God's unity, by lives devoted to all that is good, true and noble. Not a personal Messiah, nor a restoration to Palestine, is the expectation of the Jew, but the advent of a Messianic time when justice will be established, and thus God will be served in truth among all

men, in all climes and countries. These fundamental doctrines of modern Judaism were transplanted to America by great German rabbis—Einhorn, Samuel Adler, Samuel Hirsch and others—and American Judaism accepted them without reserve. The Conservative school would retain as much as possible of the old rites, the Hebrew language in the synagogue, and in the religious practices in the home. The Reform school is ready to reduce Oriental symbolism in life and liturgy to a minimum. The Radical would give the synagogue, without equivocation, a modern aspect. As the traditional Sabbath is not observed, and cannot be observed, in America by the Jews, the Radical has no scruples to open his temple on Sunday, that the civil day of rest might gradually assume for the modern Jews a religious sanction and character. Numerically speaking, the Reform synagogues are in the majority, Conservatism is clearly losing ground, while Radicalism is as yet a pioneer venture, supported by only a few rabbis and congregations. The ethical culture societies, in essence but little distinct from Jewish radical congregations and their teachings, are largely supported by the Jews. Their leader and originator, Professor Felix Adler, is an American Jew, and received his education at a German rabbinical high-school.

*Philanthropies.* The charities of the American Jews are intercongregational, all congregations contributing to their support and having a share in their administration. Jewish relief societies, hospitals (without religious, racial or other restrictions in the conditions of admission of patients), old people's homes, orphan asylums, schools for manual training, crèches, working-rooms and other agencies for the uplifting of the poor and the prevention of pauperism are found in all large cities of the Union. They are well supported, and, almost without exception, well organized. To meet the emergencies of the Russian immigration, temporary and permanent organizations were called into existence, looking to the Americanizing, in the best sense of the term, of these hapless refugees. Colonization schemes were carried out, with a view to settling some of them on farms. The trustees of the Baron de Hirsch fund in New York have done much in this direction, and the National School of Farming, created by Dr. Krauskopf of Philadelphia, is another enterprise auguring well for the future.

*Fraternities.* The Independent Order of B'nai-B'rith, founded in New York in 1843, is the parent of many secret orders among the Jews. Its object is to bring Jews into a closer fellowship, regardless of party or position, on the basis of humanity and love, and for practical philanthropy. Many of the benevolent institutions of the Jews in the United States owe their first impulse to this order, which now counts a membership of twenty-five thousand brothers, and covers seven grand lodge districts in the Union, and three more in Europe and Asia-Africa. It has disbursed over fifteen millions for charity. Patterned after

this order of B'nai-B'rith are younger fraternities, such as the Independent Order of Free Sons of Israel, Keshet Shel Barzel, Sons of Abraham, and Sons of Benjamin. The National Council of Jewish Women resulted from the Jewish Women's Congress in Chicago in 1893, at the Fair. It has sections in every city and town. Its object is to diffuse religious knowledge among the women, and enlist their co-operation in behalf of philanthropy and religion. The Jewish Publication Society, founded in Philadelphia in 1888, intends to promote Jewish literature in the English language. Its membership is recruited from all classes and sections. The Jewish Historical Society is also a young claimant for honors, devoted, as it is, to the study of the history of the Jews in the United States and America.

*Socially*, the Jews, to no great extent, have succeeded in removing the barriers between their non-Jewish neighbors and themselves. Because often excluded from the clubs of their non-Jewish fellow-citizens, they have been forced to maintain clubs of their own.

*Politically*, the Jews are divided. There is no solid Jewish vote. Most of the Jews have no political aspirations; they are loyal citizens, some of whom have held high office and many of whom have served in the army and navy. During the War of the Rebellion more than eight thousand were enlisted in the North, and that, too, when the Jewish population of the Northern states could not have been much over one hundred thousand souls. They are staunch friends of the public schools, and believers in higher education. They are found in all professions and in every line of trade. They do not burden the public institutions; their percentage of the convict population is less than their numbers would lead one to expect. They have their share of the burdens of pauperism, crime and human folly; but theirs is below the average. On the whole, the American Jews have been among the least dangerous and the most loyal of the many components of American civilization. See also ISRAEL, Vol. XIII, pp. 396 et seq.; and JEWS, Vol. XIII, p. 679.

EMIL G. HIRSCH.

JUDD, JOHN W., a British geologist; born at Portsmouth, England, Feb. 18, 1840. He became interested in mining, and studied at the Royal School of Mines; then accepted a position as analytical chemist in some iron-works at Sheffield, but became interested in geology, to which, later, he gave his attention. Beginning in 1867, he spent four years working out the relation existing between Jurassic rocks of the midland district and those of the northern and southern areas of England. In the Highlands of Scotland he did some important work on the Triassic and Jurassic rocks, besides making some new discoveries. He also investigated the Tertiary volcanoes in Scotland. He was elected a fellow of the Royal Society in 1877; appointed professor of geology in the Royal School of Mines in the same year, and in 1891 accepted the same posi-

tion in the College of Science. He was president of the Geological Society in 1886 and 1887, and in 1891 received their highest gift, the Wollaston medal.

**JUDD, ORANGE**, an American editor; born near Niagara Falls, New York, July 26, 1822. He was educated at Wesleyan University, Middletown, Connecticut, and after teaching three years took up the study of agricultural chemistry at Yale in 1850. In 1856 he became editor and publisher of the *American Agriculturist*; was also agricultural editor of the *New York Times* from 1855 to 1863; served on the Gettysburg Sanitary Commission (1863), and accompanied the army of the Potomac during the remainder of the Civil War. He was one of the projectors of the present system of railroads in Long Island. He originated a Sunday school lesson-leaf, on which is founded the *International Lesson-leaf*. In 1857 he introduced sorghum-cultivation from Europe; gave to Wesleyan University the Orange Judd Hall of Natural Sciences. Business reverses compelled him to retire from the *American Agriculturist*, and he then went to Chicago, where he founded the *Orange Judd Farmer*. Died in Chicago, Dec. 27, 1892.

**JUDD, SYLVESTER**. See AMERICAN LITERATURE, Vol. I, p. 727.

**JUDGE, WILLIAM QUAN**, an American theosophical leader; born in Dublin, Ireland, April 13, 1851; emigrated to the United States with his father in 1864, and became a law clerk; was admitted to the bar in New York (1872); became a member of the law firm of Olcott, Gonzales and Judge, and afterward opened an office of his own, practicing law until 1880; founded, with Mme. H. P. Blavatsky and Col. H. S. Olcott, the Theosophical Society of America, in 1875, becoming its



WILLIAM Q. JUDGE.

first secretary. In 1883 Mr. Judge reorganized the society and established the Aryan Theosophical Society as the local branch, with branches in other cities, the objects being to promote the study of Aryan and other Eastern literatures, religions, sciences, and "to investigate unexplained laws of nature and the physical laws of man." In 1895 there was a secession from the parent society, and Mr. Judge became president of the new organization. He at once began active work to widen the scope and membership of the American society, but failing health compelled him to stop. He died in New York City, March 21, 1896.

**JUDGE-ADVOCATE**, an officer of a court-martial, whose duty it is to prosecute an offender in the name of the United States before courts-martial. He must also see that the accused is fairly tried, that the witnesses are not asked leading questions, and that the prisoner shall make a proper plea. He shall also swear the members of the court before proceeding with the trial. See also ADMIRALTY.

Vol. I, p. 161; ARMY, Vol. II, p. 587; and COURT-MARTIAL, Vol. VI, p. 518.

**JUDGMENT**, the decision or sentence of a court of justice given after a hearing of the facts urged by the parties in interest, or after default, as the result of legal proceedings instituted for the redress of a wrong. To be valid, a judgment must be rendered by a court of competent jurisdiction, at a time and place appointed by law, and in accordance with established and proper forms. A judgment must be confined to the actual issue before the court. A final judgment is conclusive upon all the parties as to the issues directly determined by such judgment, except judgments of non suit, and other similar forms of judgment which do not undertake to decide the questions at issue, and except when called in question by appeal to a higher court or other legal method. A void judgment, however, as where the court had no jurisdiction over the parties or the subject-matter of the controversy, may be disregarded, and binds no one. But a judgment, where the court has jurisdiction is absolute in its effect, unless taken to a higher court for review, and cannot be questioned in a collateral proceeding, except in some cases when procured by fraud. Judgments may usually be set aside by the court which rendered them, at any time during the term of court at which they were rendered. Judgments of foreign courts, when properly proven, will generally receive full credit and force. The judgment of a court in one state must be enforced by the courts of other states, under the Federal constitution. See also JUDGMENT, Vol. XIII, p. 764.

**JUDGMENT**. See LOGIC, Vol. XIV, pp. 788, 797; ANALYTICAL JUDGMENTS, Vol. I, p. 797; and PSYCHOLOGY, Vol. XX, pp. 78-80.

**JUDICIAL NOTICE**, that notice which courts will take, by reason of their functions and duties, of certain facts and laws with which the law will presume them to be familiar. All such facts may be alleged before the court without offering evidence of their existence, and the judges may refer to books and documents, for their satisfaction, as to such facts or laws. The matters of which courts may generally take judicial notice are such as the laws of the land, the title, flag and seal of recognized foreign powers, public proclamations, the territorial extent of their government, legal weights and measures, abbreviations which are of universal use, and other matters of a similar character.

**JUDICIARY**. See UNITED STATES, Vol. XXIII, pp. 749, 750.

**JUDSON, EDWARD Z. C.**, an American writer of stories; born in Philadelphia in 1822; known as Ned "Buntline." He served in the United States navy, and during the Civil War was chief of scouts among the Indians, seeing much hard service. He began his story-writing in 1837, in contributions to the *Knickerbocker Magazine*; in 1848, started *Ned Buntline's Own*, a story-paper; was imprisoned in 1849 for seditious writings which appeared in his paper. After his release he began a series of stories from which he is said to have derived a large income. Among these are *The Demon of Fire* (1863); *Life in the Saddle* (1865); *The Sea Bandit* (1870);

and *Wrestling Joe* (1881). He died at Stamford, New York, July 16, 1886.

**JUGGLERY.** See **LEGERDEMAIN**, Vol. XIV, pp. 414, 415.

**JULIA**, daughter of Augustus, Emperor of Rome; born 39 B.C. She was one of the most licentious women of her day; married three times, her last husband being Tiberius Nero, whom she married 12 B.C. On account of her profligacy her marriage was dissolved, and her father banished her, in 2 B.C., to Pandataria, an island on the coast of Campania, and later to Rhegium. Augustus, on his death, bequeathed her no legacy, and forbade her ashes to be laid in his mausoleum. Tiberius, when he became emperor in A.D. 14, deprived her of all luxuries. She died the same year.

**JULIDÆ.** See **MYRIAPODA**, Vol. XVII, p. 118.

**JULLUNDUR.** See **JALANDHAR**, Vol. XIII, p. 545.

**JUMPING-HARE.** See **JERBOA**, Vol. XIII, p. 626.

**JUNCTION CITY**, a city and the capital of Geary County, northwestern central Kansas, finely situated between the Smoky Hill and Republican rivers, at the junction of the Union Pacific and the Missouri Pacific railroads. Its manufactures are various and in a thriving condition, of which the most important are those of agricultural tools, flour, furniture and carriages. It quarries much good building-limestone. Population 1900, 4,695.

**JUNEAU**, a village of southeastern Alaska, at the mouth of the Taku River, in lat. 58° 20' N., long. 134° 30' W. It is the port of a mining district which produces silver and gold. The metals can only be mined during the summer months, on account of the severity of the climate. There is a steamer line between here and San Francisco. Pop. 1890, 1,253; 1898, about 3,000.

**JUNE-BERRY**, a name given to the berry-like fruit of *Amelanchier Canadensis*, a genus of *Rosacea*. It is a shrub or small tree, whose white blossoms appear in early spring, followed by purplish, edible, berry-like fruits. It is more commonly called service-berry, and in New England shad-bush.

**JUNE BUG** (*Lachnosterna fusca*), the popular name applied to a species of beetle, frequenting lighted rooms in May and June. They also swarm in trees and shrubs, sometimes completely denuding them of their foliage. The insect is an inch long, with long, slender legs and sharp claws, by which it can hold to the foliage. It is of a dark chestnut color, and finely dotted.

Soon after pairing, the female bug deposits from forty to fifty eggs in the ground, and dies. The eggs hatch in a month. The young grubs subsist on small roots for two years, cutting them off below the surface and killing the plant. This happens to Indian corn, grass, tender lettuce in the garden, strawberries, potatoes and all kinds of flowering plants. When two years old, this grub is as large as one's little finger. It is soft, dirty white, and has a mahogany-colored head. It is usually found with its body curved in a semicircle, though it can straighten itself out and crawl slowly. In the third year the June bugs form an egg-shaped chamber by sticking particles of earth together with an adhesive

fluid. In this they pass their pupa state. In June of the same year the change into the perfect beetle is completed. An insect related to the June bug is known in England as cockchafer (see Vol. VI, p. 131) and in France as hanneton. The French government has offered a prize for an efficient means for their destruction.

**JUNGERMANNIÆ.** See **MUSCINEÆ**, Vol. XVII, pp. 68, 69.

**JUNGFRAU** ("the maiden"), a mountain in central Switzerland, the highest of the Bernese Alps, having an altitude of 13,670 feet. Its summit is covered with perpetual snow, and this fact, and its beauty of outline, make it one of the most magnificent mountains in the world. It was first ascended in 1811, by the Meyer brothers of Aarau. A railroad up the mountain has been commenced.

**JUNGHUHN**, **FRANZ WILHELM**, a German naturalist; born at Mansfeld, Prussian Saxony, Oct. 26, 1812. After 1835 he served as a physician in the Dutch colonies of Java, where he studied the ethnological, geographical, geological and botanical relations of the country. He published *Java, Seine Gestalt, Pflanzendecke und Innere Bauart* (1852); *Die Battaländer auf Sumatra* (1847); *Landschaftsansichten von Java* (1853); and other works. He died in Simbang, April 20, 1864.

**JUNGLE-GIAU** (*Bos sylhetanus*), a species of ox inhabiting Sylhet and other mountainous parts of the northeast of India. It is nearly allied to the common ox, and is easily domesticated.

**JUNGMANN**, **JOSEPH.** See **SLAVS**, Vol. XXII, p. 152.

**JUNIATA**, a river of Pennsylvania, rising in northern Bedford County, and flowing generally east, and entering the Susquehanna, 17 miles above Harrisburg. It is about 150 miles in length, unnavigable, very tortuous and the most picturesque stream in the state. The Pennsylvania canal and railroad follow it through its whole extent.

**JUNIN**, a department and lake of central Peru. The department is very mountainous, being traversed by the Andes in its eastern part. It is drained by numerous streams, the largest being the Jauja, the Perene, the Apuraro and the Pachitca rivers. Junin is rich in metals, chief of which is silver, but gold, copper, quicksilver and other metals are abundant. The region is very damp and warm, and in the western part is covered with heavy forests, which are frequented only by uncivilized Indians and cinchona and rubber-gatherers. Lake Junin, or Lake Chinchay-Cocha, lies in lat. 76° W., 13,000 feet above the sea-level, is 36 miles long and seven broad. Its marshy banks are overgrown with reeds, and inhabited by numerous water-fowl, and it abounds in fishes. Its outlet is the Jauja River. Near this lake was fought the battle of Junin. See also **PERU**, Vol. XVIII, p. 678.

**JUNK**, a Chinese vessel, often of large dimensions, which, although clumsy and admitting of little seamanship or speed, has proven seaworthy on voyages extending even to America and Europe. It has a high fore-castle and poop, and ordinarily three masts.—**JUNK** is also a popular term for the salt meat supplied to vessels for long voyages.

**JUNK CEYLON** OR SALANGA. See MALAY PENINSULA, Vol. XV, p. 321.

**JUNKER, WILHELM**, a Russo-German traveler; born April 18, 1840, of German parents resident in Moscow; studied medicine in Göttingen, Berlin, and Prague. Proceeding to Africa in 1874, in the first instance to Tunis and Egypt, he, in 1876-78 carefully explored the Makaraka country. After spending some time in Kabayendi itself, he made Khartum the center from which he traveled on various excursions, returning to Europe in 1887. A friend of Gordon and of Stanley, Dr Junker held a high place among those who have thrown light on "darkest Africa." His *Reisen in Africa* was translated by A. H. Keane in 1890. Died in St. Petersburg, Feb. 13, 1892.

**JUNKIN, GEORGE**, an American clergyman and educator; born near New Kingston, Pennsylvania, Nov. 1, 1790. In 1819 he was made pastor of the Associate Reformed Church at Milton, Pennsylvania, with the majority of whose members, in 1822, he entered the Presbyterian Church. In 1830 he founded a manual labor school at Germantown, and in 1832 became president of Lafayette College, which he had assisted in founding. From 1841 to 1844 he was president of Miami University; then, again, of Lafayette College; and from 1848 to 1861 of Washington College, Lexington, Virginia; but resigned at the beginning of the war, and went to Philadelphia, where he resided until his death. Among his publications are *Lectures on the Prophecies* (1844); *Two Commissions, the Apostolic and Evangelical* (1864); and *Political Fallacies* (1862). He died May 20, 1868.

**JUPATI PALM**, a name given to *Raphia tedi-gera*, one of the pinnate-leaved Brazilian palms, having some economic value. It abounds in the valley of the lower Amazon. The trunk is about ten feet in height, but the long pinnate leaves borne at its crown often attain four times the length of the trunk. The pith of these enormous leaves is used as a substitute for cork.

**JUPITER**, a planet. See ASTRONOMY, Vol. II, pp. 808-811; and in these Supplements.

**JURASSIC PERIOD**. See GEOLOGY, Vol. X, pp. 354-357.

**JURIEN DE LA GRAVIÈRE, JEAN BAPTISTE EDMOND**, a French naval officer; born at Brest, France, Nov. 19, 1812. He entered the navy in 1828; served in the Chinese and Crimean wars as a captain; in 1855 was made rear-admiral and placed at the head of the Asiatic squadron; in 1861 adjusted the treaty of Soledad between Mexico and the triple alliance of England, Spain and France, which was repudiated by Napoleon III. He became aide-de-camp to the Emperor and had command of the Mediterranean squadron. In 1870 he took part in the defense of Paris; after the war, was director of maps and charts in the Naval Office; and was chosen a member of the French Academy in 1888. In 1865 he was made a grand officer of the Legion of Honor, and received the grand cross in 1876. Among his writings are *Voyage en Chine* (1854); *Guerres Maritimes sous la République et sous l'Empire* (1847); *Souvenirs d'un Amiral* (1860); *Doria et*

*Barberousse* (1886); and *L'Amiral Roussin* (1889). He died in Paris, March 5, 1892.

**JURISDICTION**, the power or authority to hear and determine a cause by which judicial officers take cognizance of and decide controversies. Personal jurisdiction is that obtained by the appearance of the party before the tribunal or by service of legal process upon him. Territorial jurisdiction refers to the territorial limits within which a court is authorized to act. Jurisdiction of the cause refers to the power of the court to exercise its authority over the subject-matter in dispute. Personal jurisdiction may usually be conferred by consent of the parties, but territorial jurisdiction of the cause is conferred by law and cannot be given by consent.

**JURISPRUDENCE**. See LAW, Vol. XIV, pp. 354-367.

**JURISPRUDENCE, MEDICAL**. See MEDICAL JURISPRUDENCE, Vol. XV, p. 778.

**JURUÁ** OR YURUA, a river of Brazil rising in the Andes Conomamas, western Peru; it flows northeast, and enters the Amazon in long. 65° 44' W. It is 1,100 miles in length, and flows through low lands matted with forests, which are only frequented by Indians and rubber-gatherers. It is navigable for about 564 miles.

**JUS CIVILE**. See ROMAN LAW, Vol. XX, pp. 678, 695.

**JUS EMPHYTEUTICUM** OR EMPHYTEUSIS. See ENTAIL, Vol. VIII, p. 451.

**JUS GENTIUM**. See ROMAN LAW, Vol. XX, pp. 695-702.

**JUS NATURALE**. See ROMAN LAW, Vol. XX, pp. 703-710.

**JUSSERAND, JEAN JULES**, a French scholar and diplomat; born at Lyons, France, Feb. 18, 1855. He received the degree of doctor of *belles lettres* from the faculty of Lyons, 1878. After that he was employed continually in the diplomatic services at one post or another. He became an officer of the Legion of Honor in 1892. His literary studies were mostly in English literature, and he wrote *Le Théâtre en Angleterre depuis le Conquête jusqu'aux Prédécesseurs Immédiats de Shakespeare* (1878); *Les Anglais au Moyen Âge; la Vie Nomade et les Routes d'Angleterre au XIV<sup>e</sup> Siècle* (1884); *A French Ambassador at the Court of Charles II* (1890); *L'Épopée Mystique de William Langland* (1893).

**JUSTE, THÉODORE**, a Belgian historian; born in Brussels, Jan. 11, 1818. After finishing his education the Minister of the Interior employed him, and soon afterward he became secretary of the board for public instruction. In 1858 he became custodian of the royal museum of antiquities at Brussels, and in 1870 he was appointed professor of history in the military school. Among his works are *Histoire de la Révolution Belge de 1790* (1846); *Guillaume le Taciturne* (1873); *Léopold I et Léopold II, Rois des Belges* (1878); *La Révolution de Juillet, 1830* (1883). He died in August, 1888.

**JUSTIFICATION**, a dogma of Christian theology which emerged out of the unformulated material of Scripture at the time and in consequence of the Reformation. Its New Testament basis is in the Pauline writings, and particularly in the Epistles



to the Galatians and the Romans. Luther came to his spiritual liberty through a long familiarity with mediæval ceremony and forensic formulas, and, against all modes of obtaining divine pardon, whether absolution, masses, indulgences or other application of the power of the keys, he raised the cry of "justification by faith," and declared it to be the article "of a standing or falling church." His views were formulated in the Augsburg Confession, which declares that "men cannot be justified before God by their own powers, merits or works, but are justified freely for Christ's sake through faith." Such a declaration was an axe laid at the root of the whole mediæval system of salvation by sacraments, or any other form of priestly intervention. The free act of God proceeding through the faith of the believer left no place for the binding and loosening of sins by sacerdotal function. Justification by faith meant religious liberty to those who first heard the doctrine proclaimed.

The Lutheran conception, however, of justification was formal and forensic. It was a state in which the soul was placed by act of divine grace, and in strict form it did not involve renewed character in the pardoned. As a fact, all Protestants taught and teach that justification is concomitant with renewal, and is the beginning of a progressive sanctification. But they insist with emphasis that the free and sovereign act of divine grace must not be confounded with the regenerating influences of the Holy Ghost. The two are interwoven, but not the same. The formalism of this conception is all the greater because associated with a dogma of imputation. The ground of man's justification is the merit of Christ freely imputed to him who believes. As Calvin states, the doctrine justification "consists in the remission of sins and the imputation of the

righteousness of Christ." No Protestant formularies vary from this forensic view of the dogma. All would accept the definition of Dr. G. P. Fisher, of Yale: "Justification is thus a forensic term; it is equivalent to the remission of sins. To justify signifies not to make the offender righteous, but to treat him as if he were righteous, to deliver him from the accusation of the law by the bestowal of a pardon."

The Roman Catholic church has put more of a moral content into its doctrine of jurisdiction, and does not define it in purely formal or forensic terms. It was formulated in 1547, at the Council of Trent, in a treatise of sixteen chapters, and was a new question forced upon the attention of the council by the emphasis given to it among the reformers. With this formulary, justification is rather a process than a condition. It follows upon the reception of truth and renewing grace. "This disposition or preparation is followed by justification itself," says the *Catholic Dictionary*, "which justification consists, not in the mere remission of sins, but in the sanctification and reward of the inner man by the voluntary reception of [God's] grace and gifts, whence a man becomes just instead of unjust, a friend instead of a foe, and so an heir according to hope of eternal life."

JUTAHÍ, a river of the province of Amazonas, Brazil; rises in the southwestern part, and flows N.E. to the Amazon, which it joins near long. 67° 47' W. It is about 450 miles long, and for the most part unexplored.

JUTLAND. See DENMARK, Vol. VII, p. 80.

JUVENILE OFFENDERS. See PRISON DISCIPLINE, Vol. XIX, pp. 756, et seq.; and REFORMATORIES, in these Supplements.

JUVENTAS. See HEBE, Vol. XI, p. 593.

# K

## K A A L U N D — K A L B

**K**AALUND, HANS VILHELM, 1818-85. See DENMARK, Vol. VII, p. 93.

KABA OR KABAH. See YUCATAN, Vol. XXIV, p. 759.

KABABISH. See SOUDAN, Vol. XXII, p. 279.

KADAPAH. See CUDDAPAH (India), Vol. VI, p. 689.

KADESH. See ISRAEL, Vol. XIII, pp. 396, 397.

KADIAK, an island of southern Alaska, parallel with Alaska Peninsula and just to the east of it, lat. 58° N., long. 153° W. It is about one hundred miles long and sixty wide, and has an area of 5,000 square miles. It is very rugged, and cut by innumerable inlets; is foggy and rainy, the snow not lying long. On it are ten salmon-canneries, which give employment to over eleven hundred hands, and which are supplied almost entirely from fish caught in the Karluk River (in 1880 over three millions). Its largest village is St. Paul, on the northeast coast, which ships annually furs to the value of nearly \$300,000.

KAFFA, Crimean town. See THEODOSIA, Vol. XXIII, p. 257.

KAGIE. See SUN BITTERN, Vol. XXII, p. 653.

KAGOSHIMA, a town and the capital of the prefecture of Kagoshima, southern Japan, opposite the volcanic island of Lakura, one of the oldest cities of Japan. It was bombarded on Aug. 15, 1863, by a British squadron, and the palace of the daimio and other important buildings were destroyed. It has manufactories of pottery, especially of an imitation of old Satsuma-ware, for which it is celebrated. Population, 1898, 53,481.

KAHAU OR BLANDA, the native name of the proboscis monkey (*Simnopithecus nasalis*). This monkey has a pendent nose about three inches long. The general color of the animal is reddish brown. It is a native of Borneo. Several species of the genus are common in the East Indies.

KAHOKA, a city and the capital of Clarke County, northeastern Missouri, on the Keokuk and Western railroad, 19 miles W. of Keokuk, Iowa. It is situated in a fertile prairie region, which produces grains, butter, hay and pork, principally. It has wagon and plow factories, grain-elevators and a canning factory. Pop. 1890, 1,425; 1900, 1,818.

KAJETEUR, cataract. See GUIANA, Vol. XI, p. 250.

KAILAS GANGRI, a mountain 21,830 feet high. See HIMALAYA, Vol. XI, pp. 834, 835.

KAISER WILHELM OR NORTH SEACANAL. See CANAL, in these Supplements.

KAISER WILHELM LAND, the name of the German portion of New Guinea, together with the islands of New Mecklenburg (New Ireland) and New Pommern (New Britain).

KAKODYLE. See METHYL, Vol. XVI, p. 197.

KALABAGH MOUNTAINS OR SALT RANGE. See PUNJAB, Vol. XX, p. 108.

KALAHARA, a desert of South Africa, lying between the Orange and Zambezi rivers, mostly in Bechuanaland. In general it has many characteristics of the Sahara, but parts of it are periodically covered with vegetation, and resemble steppes rather than desert country. It consists of a large, sandy plateau of recent geological limestone formation, from 3,300 to 5,000 feet above sea-level, and it has numerous salt-pans, which show the existence of former lakes. All the rivers are periodic except the Okavango, which flows into Lake Ngami, though even this river is supplied from the northwestern regions, beyond the limits of the desert. In summer the temperature is very high and in winter moderately cold. Its inhabitants, chiefly Bushmen, are scattered and few, but near Lake Ngami are permanent settlements of some size. The estimated area is 350,000 square miles. Population, 50,000.

KALAKAUA, DAVID, a king of the Sandwich or Hawaiian Islands; born at Honolulu, Nov. 16, 1836. He was chosen king to succeed Lunalilio (1874), by a legislature especially convened for the purpose; but the validity of this election was contested by Queen Emma, widow of Kamehameha IV, who died in 1863, and several outbreaks in her interests followed. In November, 1874, he made an extended visit to the United States, returning in 1891 for the benefit of his health. The irregularities of his later years, however, had irreparably impaired his constitution. He died in San Francisco, Jan. 20, 1891. He was a progressive and strong ruler till near the close of his life, and did much to advance his country.

KALAMAZOO, a city, and the capital of Kalamazoo County, southwestern Michigan. It is situated on the Kalamazoo River, and the Michigan Central and the Grand Rapids and Indiana and the Chicago, Kalamazoo and Southern and the Lake Shore and Michigan Southern railroads. The town is noted for its beautiful streets and public places, and for its excellent institutions. It has various musical academies, an art gallery and public library, water-works and electric and gaslights. Population 1890, 17,853; in 1900, 24,404. See also KALAMAZOO, Vol. XIII, p. 826.

KALAMAZOO, a river of southwestern Michigan, rising in Hillsdale County and flowing west-northwest past Kalamazoo City into Lake Michigan at lat. 42° 40' N. It is navigable for 25 miles, as far as Allegan. It is 200 miles long.

KALB, JOHN, a French-American Revolutionary general; born in Germany, July 29, 1721. His father was a peasant; the "de" prefixed to his name is unauthorized, and he was no baron. In 1743 he became lieutenant in the French army; in 1747 rose to the rank of brigadier-general, and later took part

in the Seven Years' War. In 1768 he visited the American Colonies on behalf of the French government, and made an engagement with Benjamin Franklin and Silas Deane to take a command in the Continental army. On June 3, 1777, in company with LaFayette, he arrived in the bay of Georgetown, and was promptly appointed by Congress a major-general. He was with the army at Valley Forge, and served in New Jersey and Maryland until April, 1780. In Carolina General Kalb was appointed to command the Delaware and Maryland troops, and there united his forces with those of General Gates. At the battle of Camden, Aug. 16, 1780, Kalb commanded the American right, which was surrounded. Dismounted and bareheaded, he had a number of hand-to-hand encounters, and fell pierced by eleven wounds, from which he died three days afterward. A monument was erected to his memory in 1825 by the people of Camden, and on Aug. 16, 1886, a statue was placed in front of the court-house of Annapolis, Maryland.

**KALE.** See **CABBAGE**, Vol. IV, pp. 617, 618; and **HORTICULTURE**, Vol. XII, p. 279.

**KALEVALA.** See **FINLAND**, Vol. IX, pp. 219, 220.

**KALEVIPOEG**, the national poem of the Esthoni-ans, made up of popular songs, which Krentzwald, imitating the Kalevala, threw into the form of an epic in 1857-59. It is difficult to tell what part of the collection rests upon tradition and what part on the imagination of Krentzwald, as he destroyed his manuscript materials after writing the poem. Its chief importance lies in the fact that it throws light upon some difficult questions concerning the Kalevala. See **ESTHONIA**, Vol. VIII, p. 562.

**KALISCH, DAVID**, a German humorist; born at Breslau, Feb. 23, 1820. As a young man he was in Paris as correspondent of German newspapers. Returning to Germany in 1846, he became a contributor to the *Charivari*, a humorous paper published in Leipsic. But in 1848 he founded the *Kladderadatsch*, a similar paper, published at Berlin, which became a factor in German politics. He also published some humorous plays, such as *Hunderttausend Thaler*; *Peschke*; *Berlin, Wie es Weint und Lacht*; *Einer von Unsere Leut'*. He died in Berlin, Aug. 21, 1872.

**KALISCH, MARCUS**, a German theologian; born at Treptow, Prussia, May 16, 1828, of Jewish parents. After being educated both at the Berlin University and the Rabbinical College, he became embroiled in the political troubles of 1848 and went to England, where he was secretary to the chief rabbi. Subsequently, he wrote *A Historical and Critical Commentary on the Old Testament, Exodus, Genesis, Leviticus* (4 vols., 1855-72); *The Prophecies of Balaam* (1877); and *The Book of Jonah* (1878). He also published a Hebrew grammar. He died at Rowsley, England, Aug. 23, 1885.

**KA' -YUGA** OR **KALI-YUG**, an era. See **CHRONOLOGY**, Vol. V, p. 719.

**KA. KASKA**, a village and the capital of Kalkaska County, northwestern South Michigan, 137 miles N. of Grand Rapids, on the Grand Rapids and Indiana railroad. The region produces much lum-

ber, while the neighboring streams afford a large supply of brook-trout. It has lumber-mills and wood-work factories. Population 1900, 1,304.

**KALLITYPE PROCESSES.** See **PHOTOGRAPHY**, in these Supplements.

**KALM, PETER**, a Swedish botanist; born in East Bothnia, Sweden, in 1715. From 1748 to 1751 he was investigating the botany and natural history of North America for the Swedish government, and then became professor of natural history at Abo, Sweden. He published, besides other scientific works, *A Voyage to North America* (1753), which was an account of the soils and natural curiosities of that country. He died Nov. 16, 1779.

**KALMAR** OR **CALMAR**, town in Sweden. Pop. 1898, 12,459. See **CALMAR**, Vol. IV, p. 710.

**KALMIA**, a genus of shrubby Ericads, belonging to the northern United States and the Allegheny region, with evergreen leaves and large clusters of showy white to rose-colored and purple flowers. It is known as the American or Mountain Laurel. Common species are *K. latifolia* (Calico-bush), *K. angustifolia* (Lamkill) and *K. glauca*. The foliage has the reputation of poisoning cattle.

**KALMUCKS.** See **CALMUCKS**, Vol. IV, p. 710.

**KALNOKY DE KÖRÖS PATAK, GUSTAV SIEGMUND, COUNT DE.** an Austrian diplomatist; born at Lettowitz, Moravia, Dec. 29, 1832; served for a few years in the army; and in 1850 entered the diplomatic service. In 1860-70 he was counselor of legation at the Austrian embassy in London; in 1874-80 minister to Copenhagen; and in 1880-81 ambassador to St. Petersburg. In 1881 he was recalled to assume the office of the joint Austro-Hungarian Minister of Foreign Affairs, and practically prime-minister, in succession to Baron Baymerle—a post which Count Kalnoky resigned in 1895. He was a strong supporter of the Triple Alliance, and in 1888 was decorated by William I with the star of the Black Eagle, and by the King of Italy with the Order of the Annunciata. Died at Brünn, Feb. 13, 1898.

**KALO** (*Colocasia esculenta*), a tropical member of the Arum family (*Aracea*). It is an herb of common occurrence in wet places, and its thick, tuberous root-stalks are the source of *poi*, the national dish of the Sandwich-Islanders. See **HAWAIIAN ISLANDS**, Vol. XI, p. 529.

**KALOUSEK, JOSEF**, a Bohemian historian; born at Vamberk, Bohemia, April 2, 1838; received his education at the University of Prague; and became professor of history there. His principal work was a *History of Bohemian Constitutional Law* (1871 and 1892). He published also a *History of Charles IV* (1878); *Map of Bohemia in the Fourteenth Century*; and various other articles; and was editor of *Památky Archeologické a Nustopisné*.

**KALPA**, ceremonial sutras. See **SANSKRIT**, Vol. XXI, pp. 274-277.

**KAMA RIVER.** See **VOLGA**, Vol. XXIV, p. 279.

**KAMAKURA.** See **JAPAN**, Vol. XIII, p. 582.

**KAMBALU**, a Chinese city. See **CAMBALUC**, Vol. IV, pp. 722, 723.

**KAMEHAMEHA I**; born in Hawaii, about 1753; the conqueror and first king of the entire group of the Hawaiian Islands, better known as the Sandwich

Islands. With the aid of some European vessels and fire-arms he subdued one chief and one island after the other until he became master of the whole group in 1809. He introduced considerable civilization, and kept several white mechanics in his employ. He died May 8, 1819.

KAMEHAMEHA II, LIHOIHO, son of the preceding, was born in Hawaii in 1797. He was intemperate, and given to pleasure. After succeeding to the throne in 1819 he abolished idolatry, and prepared the way for the missionaries, who came from Boston in 1820 and soon taught the Hawaiian people to read and write, to cipher and sew. The king and queen visited London in 1824, where both died of the measles in the following year.

KAMEHAMEHA III, KAVIKAUVILI, brother of the preceding; born 1814; came to the throne in 1833, at the age of 19. Though educated by the American missionaries, he was wild and dissipated in his youth, but in 1840 he granted his people a written constitution and a code of laws, and made considerable progress in educating and civilizing his subjects; in 1848 granted land in fee simple to nearly all common people, so that each head of a family was a landholder. In 1842 and 1843 the independence of the Hawaiian Kingdom was acknowledged by the United States and by the French and English governments. The king died childless, at Honolulu, when 40 years of age, Dec. 15, 1854.

KAMEHAMEHA IV, ALEXANDER LIHOIHO, nephew of the preceding, was born in Hawaii, Feb. 9, 1834. He was also educated by the American missionaries. After visiting the United States, England and France, he succeeded to the throne in 1854. He was handsome, amiable, fond of sports and military parades, but when excited with wine he became passionate and reckless. He died at Honolulu, at the age of 29, Nov. 30, 1863.

KAMEHAMEHA V, LOTI, elder brother of the preceding; born Dec. 11, 1830. While his brother was king, he was commander-in-chief of the forces and Minister of the Interior. Although dissipated while young, he reformed when he succeeded to the throne in 1863. Thinking that the constitution was too democratic for the good of the people, he would not take the oath to support it, but called a convention of nobles and delegates of the people to form a new one. He dissolved the convention, however, and granted a constitution of less democratic character. He was strong-minded, fearless and firm, yet superstitious; generous and confiding toward some people, yet close, avaricious and suspicious toward others. He was never married, and left no heir to the throne. He died Dec. 11, 1872.

KAMINISTIQUA, a river of western Ontario, rising near lat. 49° 15' N., long. 89° 40' W., and flowing south-southeast into Thunder Bay, at Fort William, on the northwest coast of Lake Superior. It has numerous cascades and falls, Kakabika Falls being very beautiful and 125 feet in height. They are about thirty miles above its mouth. It is 120 miles long.

KAMPTULICON, a fabric. See CORK, Vol. VI, p. 402.

KANAGAWA. See YOKOHAMA, Vol. XXIV, p. 745.

KANARIS OR CANARIS, CONSTANTINE, a Grecian naval commander; born in the Isle of Ipsara in 1785. He was master of a merchant vessel before the beginning of the Greek war of independence. In 1822 he blew up the Turkish admiral's ship in the Strait of Chios, and another in the harbor of Tenedos. In 1824 he burned a Turkish frigate and transports carrying troops to Samos. In return for his exploits he was made a senator in 1847, and was Minister of Marine for Greece (1854-55). He was prominent in the revolution of 1862. He died in Athens, Sept. 15, 1877.

KANAWHA RIVER, GREAT AND LITTLE, two affluents of the Ohio, in West Virginia; the first is the principal river of the state, and forms part of the proposed Kanawha-James River canal; the second is a smaller stream, about parallel with the first, and some miles to the north. See also WEST VIRGINIA, Vol. XXIV, p. 518.

KANAZAWA, a town of Japan, about the center of the Island of Nippon, 125 miles N.N.E. of Kyoto, the capital of Ishikawa prefecture. It has a castle, used as military headquarters, fine public gardens and an industrial museum. It has potteries, which are famous for their red and gold porcelain-ware, known as Kaga-ware, and it also has manufactories of bronze statuary, overlaid with silver and gold, and of fans. Its mean annual temperature is 54.8° F. Population 1898, 83,595.

KANDHS. See MADRAS, Vol. XV, p. 185; and INDIA, Vol. XII, p. 777.

KANE, a borough of McKean County, northern Pennsylvania, on the Pittsburg and Western and the Pennsylvania railroads, 95 miles E.S.E. of Erie. It is in an oil, natural-gas and lumber region, and is a summer resort. It has manufactories of brush heads and handles, clothespins, lamp-black and glass; foundries, lumber-mills and railroad repair-shops. Population 1890, 2,944; 1900, 5,296.

KANE, SIR ROBERT, an Irish chemist; born in Dublin in 1810. He was educated for the medical profession; in 1832 was received as a member of the Royal Irish Academy, and in the same year projected the *Dublin Journal of Medical Science*. In 1840 he received the gold medal of the Royal Society of London for his researches into the coloring-matter of lichens, and in 1847 the Cunningham gold medal of the Royal Irish Academy for his discoveries in chemistry. From 1834 to 1847 he was professor of natural philosophy to the Royal Dublin Society. In 1846 he originated the Museum of Industry in Ireland; was appointed the first director and the same year received from the Lord-Lieutenant the honor of knighthood. He was for a number of years president of the Queen's College, Cork, resigning this position, together with the directorship of the museum, in 1873. In 1876 he was elected president of the Royal Irish Academy. His chief books are *Elements of Chemistry* (1842); an *Industrial Resources of Ireland* (1844). He died Feb. 16, 1890.

KANGAROO-RAT, the popular name of a small Australian marsupial of the subfamily *Hypsiprym-*

*nine*. It is about as large as a rabbit, and very fleet. It does not much resemble the true kangaroo, either in structure or habits. The natives call it "potoroo," and consider it excellent food. The name is also applied to a small North American rodent of the genus *Dipodomys* and its allies. It resembles the jerboa in form and habits.

KANKAKEE, a city and the capital of Kankakee County, northeastern Illinois. Through it pass the Kankakee River and the Illinois Central, the Cleveland, Cincinnati, Chicago and St. Louis, the Indiana, Illinois and Iowa and the Kankakee and Seneca railroads. Limestone is quarried to a considerable extent in its neighborhood. It contains the Eastern Illinois Hospital for the Insane, which cost \$2,000,000. This asylum has accommodations for 2,000 patients, and has 500 employees. Population 1890, 9,025; 1900, 13,595. See also KANKAKEE, Vol. XIII, p. 842.

KANKAKEE, a river of northeastern Illinois, rising in St. Joseph County, Indiana, and flowing W.S.W. into Illinois, past Kankakee city, till it meets the Des Plaines River and helps to form the Illinois. Length, 225 miles.

KANSAS, popularly called the "Sunflower State," has an area of 82,080 square miles, 52,572,160 acres.

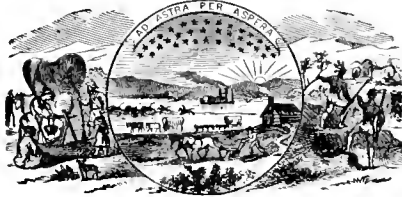

STATE SEAL OF KANSAS.

The census returns of 1890 gave the population as 1,427,096. In 1880 the inhabitants numbered 996,096, the gain for the ten years being 43.27 per cent. The number of people to the square mile was 17.47 in 1890, while in 1870 it was but 4.46, a gain in 20 years of more than 300 per cent. The census reports gave nine cities in the state, containing 165,879 people, which was but 11.62 per cent of the population. In 1880 the number of cities was four, the percentage of population residing in them being 5.58. In 1890 the number of males was 752,112, the number of females 674,984; the per cent of native-born population 89.64, of foreign-born, 10.36; the negro population 49,710, an increase of 6,603 in ten years. The 12th census of 1900 gave the population at 1,470,495, an increase of 43,399 since 1890.

The soil of Kansas is well adapted to agriculture, and is highly productive except some of the western part, where the lack of sufficient rainfall has been a drawback to successful farming. Irrigation is being developed rapidly, the Arkansas river, smaller streams, and artesian wells affording abundant water.

Kansas had 166,617 farms according to the census returns of 1890, of the average size of 181 acres, and a total of 30,214,456 acres, about 75 per cent of which is improved. The total valuation of the land, fences, buildings, machinery, implements and live-stock was given as \$706,664,141; the estimated value of the farm products for the year was \$95,070,-

080; the number of horses, 930,305; mules, 95,937; neat cattle, 3,188,033, which included 741,786 milch cows; swine, 4,022,933; and sheep, 401,192. The clip of wool was 2,253,240 pounds.

The census of 1890 shows that Kansas ranked high among the states in both acreage and production of the cereals. The following table shows the area, production and rank held, as well as the percentage of the entire yield in the United States:

PRODUCT.	ACRES.	PER CENT.	R'NK	BUSHEL.	PER CENT.	R'NK
All cereals	10,574,180	7.54	3d	337,753,689	9.60	3d
Corn ----	7,314,765	10.15	3d	259,574,568	12.23	3d
Wheat ---	1,582,635	4.71	9th	30,399,871	6.49	6th
Oats ----	1,463,526	5.17	7th	44,629,034	5.52	5th
Rye-----	199,146	9.17	4th	2,917,386	10.26	4th

The increase in agriculture since the census year has been very great, as will be shown by the returns made for 1895, in which year the area of field crops was 21,576,704 acres, exceeding the previous year by almost 2,000,000 acres. The aggregate value of the crops produced on this acreage was \$77,663,664, while the aggregate value of all crops and products from field, orchard and dairy was given as \$128,503,791, which, added to the value of live-stock on hand March 1, 1895, gave a total valuation of \$201,443,950. Following is a summary of some of the principal crops, the acreage devoted to their culture, and the quantities raised, with the value of the same:

PRODUCT.	ACRES.	BUSHEL.	VALUE.
Winter wheat ----	4,056,514	15,512,241	\$ 7,255,571
Spring wheat ----	115,457	488,819	207,547
Corn -----	8,394,871	201,457,396	46,189,772
Oats-----	1,606,343	31,664,748	5,620,188
Irish potatoes----	96,228	7,035,866	2,506,358
Sorghum -----	312,730	-----	2,533,952
Flax-----	233,993	1,639,530	1,286,471
Broom-corn*----	134,487	60,511,360	1,223,159
Hungarian and millet†-----	301,672	611,160	2,050,786
Kaffir corn†-----	184,198	639,993	1,686,389

Other products of great value were rye, barley, buckwheat, sweet-potatoes, castor-beans, cotton, hemp, tobacco, milo maize, Jerusalem corn, timothy, clover, blue-grass, alfalfa, orchard-grass, other tame grasses, and prairie-grass as pasture. Other items that went to swell the grand total of products for the year were animals for slaughter, poultry and eggs sold, the wool-clip, cheese, butter and milk sold, garden products marketed, horticultural products marketed, wine, honey, beeswax and wood.

Stock-raising has been one of the most prominent of the agricultural industries since the settlement of the state. For the ten years from 1885 to 1895 the value of the live-stock of the state averaged about \$120,000 annually, and the yearly value of live-stock

\* Production of broom-corn given in pounds. † Hungarian and millet and Kaffir corn in tons.

products over \$40,000,000. For the first four months of 1896 the number of cattle sold in the market of Kansas City, which were raised in Kansas, was 238,913; of hogs, 562,737; of sheep, 184,609; and of horses, 16,401. The census reports of 1890 showed that in the preceding ten years Kansas had added to the "other cattle on farms" almost 1,500,000.

By the census returns for 1890 it was shown that Kansas had 4,471 specified manufacturing industries, employing capital to the amount of \$43,926,002; having 32,843 employees, to whom \$16,328,485 were paid as wages, and turning out \$110,219,805 worth of finished products. Slaughtering and meat-packing at wholesale headed the list, with \$44,592,671 as the value of the annual production; flouring and grist mill products came next, with a return of \$17,420,475; cars and general shop construction was another important industry, as were carpentering, mason, brick and stone work, printing and publishing, and foundry and machine-shop products.

For the year ending June 30, 1895, the report of the different lines of railroads operating in Kansas

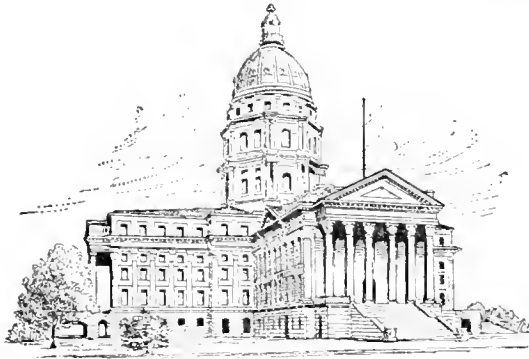

CAPITOL BUILDING, TOPEKA.

showed 9,025.20 miles. The census returns for 1890 showed 8,806.45 miles of road in operation, and that the increase during the ten years preceding had been 5,421.71 miles, or a gain of 160.18 per cent. During the fiscal year above mentioned the traffic earnings of the roads had been \$114,838,845, a decrease of over \$10,500,000 as compared with the previous year. The operating expenses amounted to \$80,670,223, the income from operation and other sources a little in excess of \$75,000,000.

The assessed valuation for taxation of the property of the state for 1894 was as follows: Land, \$173,075,265; town lots, \$61,825,141; personal property, \$40,854,934; railroads, \$59,764,683; making a grand total of \$335,530,023.

Few states have the school system so well conducted as has Kansas. By constitutional enactment the interest from the invested proceeds of 500,000 acres, granted by Congress in 1841 to all new states thereafter organized, and also of the sixteenth and thirty-sixth sections of every Congressional township, goes to the financial support of the schools. From the sales of these lands there has been derived nearly \$7,000,000, the interest on which amounts to almost \$500,000 annually, which, with the funds derived from district taxation, amounts to almost \$5,000,000.

The school statistics of 1894 make the following showing:

Number of persons of school age-----	496,139
Number of pupils enrolled-----	393,849
Average daily attendance-----	252,215
Number of teachers employed-----	11,903
Average length of the school year-----	25 weeks
Estimated value of school property-----	\$11,193,396

Almost the entire amount of the school fund of \$5,000,000 was expended, of which \$3,065,118 was for salaries paid to teachers. More than one hundred cities of the state have graded schools; there are numerous county high-schools and three state schools, the University at Lawrence, the Normal School at Emporia and the Agricultural College at Manhattan. Among the institutions of higher education the University of Kansas (q.v., in these Supplements) stands at the head. The denominational colleges are many and well sustained. Among the most prominent of these are the Baker University, located at Baldwin, with about 500 students, and under control of the Methodist Episcopal Church; the Central College, at Enterprise, with 170 students in 1895, under the auspices of the Lutheran Church; Bethany College, at Lindsborg, with 444 students in 1895, also controlled by the Lutheran Church; the College of Emporia, located at the city of the same name, with 120 students in 1895, managed by the Presbyterian Church; Highland University, at Highland, also controlled by the Presbyterians, with 75 students; Kansas Wesleyan, at Salina, with 305 students, and an institution controlled by the Methodist Episcopal Church; Midland College, Atchison, under the auspices of the Evangelical Lutheran Church, with 120 students; Ottawa University, Ottawa, belongs to the Baptist Church, and in 1895 had 402 students; Southwest Kansas College, established by the Methodist Episcopal Church, at Winfield, with 130 students; St. Benedict's College, Atchison, founded by the Roman Catholic Church, with 170 students; St. Mary's College, at the town of the same name, is also a Roman Catholic institution, with 207 students; Washburn College, Topeka, managed by the Congregational Church, with 200 students; Fairmount College, Wichita, also a Congregational institution, had about one hundred students. Other institutions are the Lewis Academy, at Wichita, Presbyterian; McPherson College, at the town of the same name, controlled by the Dunkard Church; St. John's Lutheran College, Winfield. Cooper Memorial College, at Sterling, is under the auspices of the United Presbyterian Church; Soule College, originally under the control of the Presbyterian Church, is now a Methodist Episcopal institution; Bethel College, at Newton, is controlled by the Mennonite Church; and Lane University, at LeCompton, by the United Brethren Church.

The religious element in Kansas is very strong, about one fourth of the entire population being communicants of the 4,114 organizations of the 27 different denominations. The total value of the church edifices in the state is given as \$8,679,608; besides which, large amounts are invested in colleges, schools, hospitals, orphans' homes and other

benevolent institutions. The estimated seating capacity of the churches of the state is 768,000. The larger denominations have membership and property as follows:

DENOMINATION.	MEMBERS.	VALUE OF PROP- ERTY.
Congregationalists -----	12,597	\$ 531,900
Presbyterians -----	24,935	1,900,700
Baptists -----	27,604	799,899
Lutherans -----	28,135	624,660
Christians -----	34,737	498,401
Roman Catholics -----	72,951	1,309,950
Methodist Episcopalians -----	101,600	2,322,890

In February, 1896, the number of national banks in Kansas was 116, whose aggregate capital and surplus was \$11,075,500, their deposits amounting to \$16,914,666. On the same date there were 287 state and 117 private banks, whose aggregate capital was \$8,465,000, with deposits amounting to the sum of \$15,522,033.

Coal is found in 24 of the counties of Kansas, and is mined in 20 of these. It is of the bituminous kind, excellent for gas and coke, yielding 63 per cent of the latter, the best Pennsylvania coal only producing 66 per cent. Statistics of the annual production of coal are not kept; but the two counties of Cherokee and Crawford reported nearly 3,000,000 tons mined in 1894, which had at the mines a value of more than \$3,500,000. A single mine at Frontenac produced over 8,000,000 bushels, of a value of more than \$400,000. Oil has been found in many places within the state, and is being developed rapidly. Natural gas also is produced over a wide range of territory, the estimate for both oil and gas being about 8,500 square miles in the southeastern part of the state. Kansas leads all other states in the production of zinc-ore and the manufactured product called spelter. In 1895, 25,775 tons of zinc were taken from a territory less than six miles square, in Cherokee County, located in the southeastern corner of the state, and from the same field 25,000,000 pounds of lead were taken in the same year. In 1896 there were 12 companies, employing about 800 men, engaged in the manufacture of salt, at Hutchinson, in the central part of the state. While the product is of as good quality as any produced in the United States, the industry is hampered by the fact of over-supply, and the amount produced is but a small fraction of the capacity.

The state charitable, correctional and penal institutions, which are many, are well sustained by liberal legislative appropriation. The Institution for the Education of the Deaf and Dumb, located at Olathe; the Institution for the Education of the Blind, at Kansas City; the Institution for the Education of Feeble-Minded Children, at Winfield; the Soldiers' Orphans' Home, at Atchison; the State Soldiers' Home, at Atchison; the State Insane Asylum, at Topeka; the State Insane Asylum, at Osawatomie; the Reform School for Boys, at Topeka; the Industrial School for Girls, at Beloit; the State Industrial Reformatory (for first felons), at Hutch-

inson; and the state penitentiary, at Lansing, are all models in the way of management, and compare favorably with like institutions in any of the states.

Kansas had in 1895 about 20 public libraries of over 1,000 volumes each, in addition to which were about 30 school and college libraries of the same minimum size, in addition to which were many connected with societies and public institutions, in all aggregating about 70, with a total of nearly 225,000 volumes. The total number of public libraries, large and small, was 458, their combined volumes numbering 162,985.

At the opening of 1899 there were 683 newspapers published in the state, 104 of the 105 counties having one or more. Papers were published in 343 of the cities, towns, and villages, of which 104 were county capitals; 53 of these papers were daily issues, 7 semiweekly, 592 weekly, 3 semimonthly, 26 monthly, and 2 quarterly.

The following table shows the population of 20 of the principal cities of Kansas as ascertained by the 12th decennial census of 1900. The number of native-born citizens is also given.

CITIES.	POPULATION. 1800.	POPULATION. 1900.
Kansas City.....	38,316	51,418
Topeka.....	31,007	38,608
Wichita.....	23,853	24,671
Leavenworth.....	19,768	20,735
Atchison.....	13,963	15,722
Fort Scott.....	11,946	10,322
Lawrence.....	9,997	10,862
Pittsburg.....	6,697	10,112
Hutchinson.....	8,682	9,379
Emporia.....	7,551	8,223
Parsons.....	6,736	7,682
Ottawa.....	6,248	6,934
Arkansas City.....	8,347	6,140
Salina.....	6,149	6,074
Argentine.....	4,732	5,878
Newton.....	5,695	6,208
Winfield.....	5,184	5,554
Junction City.....	4,502	4,695
Osage City.....	3,469	2,792
Independence.....	3,127	4,851

The following is a list of the governors of Kansas, with their terms of office: Charles Robinson, 1861-62; Thomas Carney, 1862-64; Samuel J. Crawford, 1864-68; James M. Harvey, 1868-73; Thomas A. Osborn, 1873-76; George T. Anthony, 1876-79; John P. St. John, 1879-83; George W. Glick, 1883-85; John A. Martin, 1885-87; Lyman U. Humphrey, 1887-93; Lorenzo D. Lewelling, 1893-95; Edmund N. Morrill, 1895-97; John W. Leedy, 1897-99; W. E. Stanley, 1899-1901. See also KANSAS, Vol. XIII, pp. 832-34.

KANSAS, a village of Edgar County, central eastern Illinois, on the Peoria, Decatur and Evansville and the Cleveland, Cincinnati, Chicago and St. Louis railroads, 160 miles S.W. of Chicago. It is in a farming region, and has tile factories, a large fruit-canning establishment, grain warehouses; and the repair-shops of the Peoria, Decatur and Evansville railroad are located here. Pop. 1000, 1,040.

KANSAS, a river of northeastern Kansas, formed by the union of the Smoky Hill and Solomon rivers

in Dickinson County. Its direction is east, and its length is about 200 miles.

**KANSAS, UNIVERSITY OF**, a co-educational institution maintained and controlled by the state of

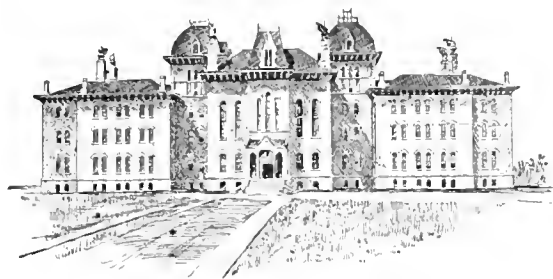

MAIN BUILDING, UNIVERSITY OF KANSAS.

Kansas; situated at Lawrence. Advantage was taken of the Congressional grant to educational institutions of 1862, and in 1864 the State University was chartered by the legislature. The institution is governed by a board of regents, who are appointed by the governor of the state. The regents in turn elect a chancellor, who is the official head of the institution. The University is divided into five schools or departments: law, pharmacy, engineering, fine arts, and liberal arts. Eight buildings stand upon a campus of forty acres. Completely equipped scientific laboratories, large museums, and a library of about 30,000 volumes furnish a part of the educational facilities. Tuition is free to residents of the state; for non-residents only a nominal fee is charged. The institution is supported by legislative appropriation. In 1898 its income was \$152,000, and the amount of its productive funds \$142,000. In 1898 there were 1,064 students in attendance, with 58 instructors.

**KANSAS CITY**, the capital of Wyandotte County, Kansas. In 1886 it was incorporated as a city, and was formed by the union of Wyandotte, Armourdale, Armstrong and several smaller communities, all suburbs of Kansas City, Missouri. Kansas City, Kansas, is on the north side of the Kansas River and west side of the Missouri river, where the two streams join. Kansas City, Kansas, and Kansas City, Missouri, are in all respects one city, the only reason for the separation being the state line, which marks the limits of each city and compels two distinct governments. Through the different parts of Kansas City, Kansas, run five railroads: the Atchison, Topeka and Santa Fé, the Missouri Pacific, the Kansas City, Fort Scott and Memphis, the Union Pacific and the Kansas City and Northwestern. While all these roads maintain stations in Kansas City, Kansas, no traffic of any extent is done outside of the Missouri city. A belt line connects the two cities and all railroad lines. Kansas City, Kansas, is also connected with the Missouri side by cable and electric roads. It is the second largest stock market in the world and one of the largest packing-house centers in the United States, the six establishments which have given the Kansas City a world-wide reputation for pork and beef products all being in Kansas. It receives annually about

3,000,000 head of live stock, of which 65 in a hundred are hogs, 26 per cent cattle and 6 per cent sheep. Of the food animals received, about 60 per cent are disposed of at the packing-houses. The live-stock traffic in 1893 amounted to \$92,000,000. In addition, many large grain-elevators are located there in connection with the Missouri grain exchange. Over \$11,000,000 are invested in manufactures, the annual product being valued at \$45,000,000, and over 7,500 persons being employed. Population 1880, 3,200; 1890, 38,310; 1900, 51,418.

**KANSAS CITY**, the second city in size in the state of Missouri, in Jackson County, on the south bank of the Missouri and east bank of the Kansas rivers, where the latter stream flows into the former. Kansas City, Missouri, and Kansas City, Kansas, are in reality one, but are legally separated by the state boundary-line. In 1854 Kansas City, then known as Westport Landing, was the outfitting and starting point for the California overland parties who followed the "Santa Fé trail." The Missouri River is navigable, and Kansas City, before the advent of the railroads, was one of the most important shipping-points for the then extensive steamer trade.

In Kansas City, Missouri, center 21 lines of railroad, over which the traffic of the two cities is conducted; among them are the Union Pacific, the Atchison, Topeka and Santa Fé, the Chicago, Rock Island and Pacific, the Missouri Pacific, the Wabash, the Chicago and Alton, the Chicago, Burlington and Quincy, the Hannibal and St. Joseph, the Chicago, Milwaukee and St. Paul and the Kansas City, Pittsburg and Gulf. As nearly as can be estimated it is the center of commerce for nearly nine hundred thousand square miles of territory, embracing Kansas, Colorado, the Indian Territory, parts of Missouri, Nebraska and Iowa. Consequent upon this large amount of tributary territory, Kansas City has large wholesale grocery, hardware, implement and other interests, and is the grain-center of the West. The aggregate capital of the manufacturing establishments in 1890 was \$14,000,000, and the annual products were valued at \$32,000,000; 15,000 persons were employed and \$9,500,000 were paid in wages. The packing-house and live-stock interests, which are all in Kansas City, Kansas, are of course not included in these estimates. The average grain receipts are over twenty-two million bushels annually. Kansas City is for the most part situated upon high bluffs overlooking the Missouri. There the retail and residence districts are situated, while in the bottom lands along the two rivers are the wholesale and railroad interests. It is well supplied with cable and electric railways. The passenger traffic of all the railroads is handled in one large union depot. The Missouri River is spanned by a bridge 1,387 feet in length, and five bridges cross the Kansas River. Three large parks are maintained, and a public library. Schools of medicine, dentistry, pharmacy, etc., are located here. The city is well provided with hospitals and charitable institutions. Its growth has been almost entirely since 1870. In 1870 there were 32,290 inhabitants; 1880, 55,276; 1890, 132,416; 1900, 163,752.

**KANSUH.** See CHINA, Vol. V, p. 638.



KANTEMIR, ANTIOKH DMITRIEVICH. See RUSSIA, Vol. XXI, pp. 105, 106.

KAPP, FRIEDRICH, a German author; born at Hamm, Westphalia, April 13, 1824. He studied at Heidelberg, and practiced law in Germany until 1850, when he removed to New York. He continued his practice, and took part in public affairs. In 1860 he was a Presidential elector; for three years before his return he was commissioner of immigration in New York. His knowledge of America made him valuable at home in International legislation, and in 1870 he returned to Germany, and in 1871 became a member of the German Diet. He published *The Slave Question in the United States* (1854); *Life of General Steuben* (1858); *A History of German Migration into America* (1867); *On Immigration and the Commission of Immigration* (1870); and *Frederick the Great and the United States* (1874). He died in Berlin, Oct. 27, 1884.

KARA, river. See RUSSIA, Vol. XXI, p. 73.

KARACHI. See KURRACHEE, Vol. XIV, p. 160.

KARAJICH, VUK STEFANOVIC, philologist. See SERBIA, Vol. XXI, p. 691.

KARAK OR KHARAJ, an island of Persia, in the northern part of the Persian Gulf, lat. 29° 14' N., long. 50° 20' E. It is about fifteen miles in circumference, and of coral formation; a safe anchorage during southwest storms is obtained here. On its northern side are a Dutch fort and a village inhabited by about 1,000 Arabs.

KARAKORUM MOUNTAINS. See KUEN-LUN, Vol. XIV, p. 153.

KARAMAN. See CARAMAN, Vol. V, p. 82.

KARELIAN. See LAPLAND, Vol. XIV, p. 307.

KARENS, a race occupying part of British Burma. They are related to the Chinese and Siamese, being of Turanian and Mongolian descent. Their Burmese neighbors formerly oppressed them to such an extent that they took to the highlands in central and lower Burma, between the Irawadi and Menam rivers, where they devoted themselves somewhat to agriculture in a small way, but mostly to marauding expeditions. They were among the first tribes to avow fealty to Great Britain, and since professing loyalty have emigrated into the valleys to some extent, removing even into western Siam. In 1828 Christianity was introduced among them, and since that time has spread rapidly, so that it is estimated at present there are some 100,000 Christian converts. A college, theological seminary and numerous schools have been founded, and 500 churches with over one hundred native pastors. As a result, they are becoming civilized rapidly, and modern industries are being introduced among them. The Karens are divided into several tribes and clans, each of which has its own dialect. The three principal tribal branches are the Sgaus, Pwos and Bghais, the last named being least civilized. Their language, like the Chinese, is monosyllabic.

KARLSKRONA, a fortified seaport town of southern Sweden. It is the principal station of the Swedish navy and has a very secure harbor, capable of accommodating vessels of 20 feet draught. Canvas, linen cloths, leather and naval

equipments are manufactured here, and metals, potash and other Baltic products are exported. Population 1897, 23,106. See CARLSKRONA, Vol. V, p. 112.

KARLUK, a seaport town of ALASKA, q.v., in these Supplements.

KARMA, LAWS OF. See BUDDHISM, Vol. IV, p. 433.

KARMATHITES OR CARMATHIANS, a branch of the Ismailian sect of Islam. See MOHAMMEDANISM, Vol. XVI, pp. 586-588, 594.

KARNAK, ruins. See EGYPT, Vol. VII, pp. 777, 778.

KARNOW. See JAGERNDORF, in these Supplements.

KARPINSKI, FRANCISZEK. See POLAND, Vol. XIX, p. 303.

KARR, JEAN BAPTISTE ALPHONSE, a French author; born in Paris, Nov. 24, 1808. After being educated at the Collège Bourbon he became an instructor there. He wrote his personal love romance under the title *Sous les Tilleuls*, which was succeeded by other romances entitled *Une Heure Trop Tard*, and *Vendredi Soir*. In 1839 Karr became chief editor of *Figaro*, and soon after issued *Les Guêpes*, a satirical review, which became very popular, and his fanciful *Voyage Autour de mon Jardin* (1845). For many years he practiced floriculture and horticulture at Nice. His miscellaneous writings have been gathered, and a selection from them published in 1877, called *L'Esprit d'Alphonse Karr*. He died at Nice, Sept. 30, 1890.

KARROO (a Hottentot word signifying "dry or barren"), a term applied in Cape Colony primarily to the barren plateaux lying between the Nieuwveld, Roggeveld, Langeberg and Zwarteberg ranges, and thence to barren plains generally. The soil of the Great Karroo consists of shallow but fertile deposits of red clay on a substratum of blue schistose slate. It is in many places impregnated with saline matter, but when irrigated produces good crops. The Great Karroo is about three thousand feet above the sea-level, and the Little Karroo, or Kannaland, one thousand feet lower. Both are subject to great extremes of temperature. They evidently at one time formed the beds of lakes, and now abound in fossil saurian remains peculiar to this region. Large flocks of sheep are pastured on the Karroo, and the value of land has quintupled with the last few years. See also ORANGE RIVER FREE STATE, Vol. XVII, p. 813.

KARST, THE. See ALPS, Vol. I, p. 631.

KARUIZAWA, a town in the principality of Shinano, Japan, at the foot of the western descent of the Usui pass, 85 miles N.W. of Tokyo, at an altitude of 3,200 feet. Near by is the active volcano, Asama-yama, 8,282 feet high. To the south are the magnificent rocks and groves of Myogi-san. Its delightful surroundings and climate make it a favorite summer resort. In 1893, a railway connecting the termini of the trunk railroad between Tokyo and the west, which was broken by the Usui pass, 4,000 feet high, was opened. This section goes through no fewer than 25 tunnels. Population, 2,000.

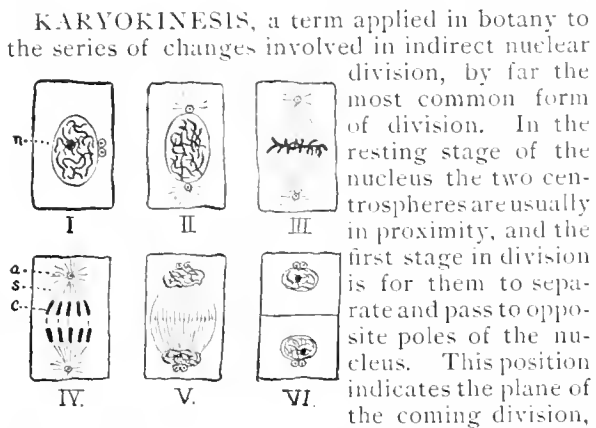

KARYOKINESIS, a term applied in botany to the series of changes involved in indirect nuclear division, by far the most common form of division. In the resting stage of the nucleus the two centrospheres are usually in proximity, and the first stage in division is for them to separate and pass to opposite poles of the nucleus. This position indicates the plane of the coming division, which is always at right angles to the axis connecting the two centrospheres. In the nucleus itself the fibrillar network then breaks up into a definite number of segments, known as chromosomes. The tangle of somewhat V-shaped chromosomes loosens by the movement of the chromosomes to the surface of the nucleus, where they mass in an equatorial position. At the same time, delicate threads pass from one chromosome to the other about the body of the nucleus, as meridian lines about a globe, forming what is known as the "spindle," of which the centrospheres are the two poles. The chromosomes collected in the equatorial plane now split longitudinally, the two halves of each primary chromosome moving along the spindle-fibers toward opposite poles. This movement continues until the daughter chromosomes are collected at each pole, where they constitute a nucleus, the separated chromosomes uniting to form the fibrillar network of the resting stage. Thus two distinct nuclei are formed, and this division is usually followed by the formation of a cell-wall between the two, in the equatorial plane of the spindle. The accompanying figure shows different stages (I-VI) in nuclear division: *a*, the centrospheres, together in I, in polar position in II-IV, paired again by division in V and VI; *n*, the nucleus showing nucleolus, apparent in I and VI; *s*, the spindle, apparent in III-V; *c*, the chromosomes, entangled in I and II, in equatorial position in III, moving toward the poles in IV, entangled again in the new nuclei in V and VI. (From Guignard and Strasburger.)

KASHAN. See CASHAN, Vol. V, p. 175.

KASKASKIA, a post village of Randolph County, southwestern Illinois, on the right bank of the Kaskaskia River, about seven miles from its mouth, at Chester, which is the nearest railroad station. It was settled by the French about 1680, and was the first capital of Illinois. It was once a large and important place, but has declined. Population 1000, 177.

KASKASKIA, a river of Illinois, rising in Champaign County, in the central eastern part of the state, and flowing southeast into the Mississippi at Chester. Its length is nearly 300 miles, and it is navigable for about 50 miles.

KASSASSIN, a lock on the canal between

Ismailia and Zagazig, in Egypt, 21 miles W. of Ismailia. In the Egyptian campaign of 1882 a sharp action was fought here on August 28th, in which the insurgent Egyptian troops under Arabi Pasha (q.v., in these Supplements), who had attacked the position held by the British troops, commanded by General Graham, were completely routed. The feature of the conflict was the charge made by the Heavy Brigade, it being the first battle in which the Household Cavalry had participated since their charge at Waterloo.

KASSON, JOHN ADAMS, an American statesman; born at Charlotte, Vermont, Jan. 11, 1822; studied law in Massachusetts, and practiced in St. Louis until 1857, when he moved to Des Moines, Iowa; was first assistant postmaster-general in 1861; member of Congress 1863-67; postal commissioner to Paris 1863-67. In 1868-73 he was in the Iowa Legislature, but returned to Congress (1873-77); was minister to Austria (1877-81); in Congress (1881-84); minister to Germany (1884-85); president of the committee on the centennial of the adoption of the constitution in Philadelphia (1887); special envoy to the Samoan Congress at Berlin (1889); special reciprocity commissioner (1897); and member of the Canadian-American Joint Commission (1898-99).

KATHAY. See CHINA, Vol. V, pp. 627-28.

KATHODE OR CATHODE. See ELECTRICITY, § 95, in these Supplements.

KATKOFF, MICHAEL NIKIFOROVITCH, a Russian politician and journalist; born at Moscow in 1818. He studied at the University of Moscow, Königsberg and Berlin, and for some time filled the chair of philosophy at Moscow. In 1856 he founded the *Russian Messenger*, and in 1861 he became editor of the *Moscow Gazette*, the organ of the University, and eventually made it the most influential journal in Russia. At first an advocate of parliamentary government and reform, Katkoff was converted by the Polish rising of 1863 into a leader of the Pan Slavist movement and a supporter of reactionary government in Russia. He acquired much influence, and is said to have been mainly instrumental in persuading Alexander III to adopt his conservative and reactionary policy. He died at Snamensky, Aug. 1, 1887.

KATRINE, LOCH. See GLASGOW, Vol. X, p. 642; and TROSSACHS, in these Supplements.

KATTEGAT, an arm of the North Sea, a continuation of the Skager Rock, between Sweden and Denmark. It is 150 miles in length and from 40 to 70 in width. It connects with the Baltic Sea by the Sound and the Great and Little Belts. Dangerous sand-banks exist in the Kattegat.

KATTIMANDU, the native name of the latex (milky juice) of an East Indian *Euphorbia*, a plant of the spurge family. As all latex has the general properties of caoutchouc, that of this species is of some use in the arts.

KATYDID, the popular name of many American insects of the grasshopper family (*Locustidae*). The name is an imitation of their peculiar shrill

note, heard only at night. They are large green insects of arboreal habits. At least a dozen species occur in the United States, but *Cyrtophyllus concavus* is perhaps the best known.

KAUAI. See HAWAIIAN ISLANDS, Vol. XI, p. 532.

KAUFMAN, a city and the capital of Kaufman County, northeastern Texas, on the Texas Trunk and the Texas Midland railroads, 36 miles S. E. of Dallas. Hay, corn and oats are largely raised, but cotton is the leading product. It has an ice factory, cottonseed-oil mill, and is supplied with city water and electric lights. Population 1890, 1,282; 1900, 2,378.

KAUFMANN, CONSTANTINE VON, a Russian soldier; born near Ivangorod, in Russian Poland, of German parents, May 3, 1818. Entering the army as lieutenant of engineers in 1838, he fought against the Circassians in the Caucasus, and especially distinguished himself at the siege of Kars in 1855. In 1867 he was appointed governor-general of Turkestan, and at once set himself to organize this province, then newly conquered; in 1868 he occupied Samarcand, and in 1873 conducted a successful campaign against Khiva. The strong position of Russia in Central Asia is mainly due to his victories. In 1879, when the Russians had been defeated by the Turkomans, he was put at the head of an expedition against Merv, which was successful. He died May 16, 1882.

KAUKAUNA, a city of Outagamie County, central western Wisconsin, on both sides of the Fox River, and on the Chicago and North-Western railroad, 23 miles above Green Bay. It has pulp, paper and flour mills, sash and blind factories, machine-shops, a foundry and the repair-shops and roundhouse of the Chicago and North-Western railroad. Population 1890, 4,667; 1900, 5,115.

KAVA-KAVA, the native name of *Piper methysticum*, a shrub of the Pacific Islands, belonging to the pepper family. The medicinal value of its roots has long been known to the natives, who make from them a preparation used in treatment of the genital organs. It also receives the name of *kawa* and of *ava-ava*.

KAVELIN, KONSTANTIN DMITRIEVICH, a Russian author; born in St. Petersburg, Russia, Nov. 4, 1818. He was educated at the Moscow University, becoming a professor there in 1844. Later he studied higher education in France and Germany, on which he wrote several articles. During the last few years of his life he was in the Military Legal Academy. One of his aims was the emancipation of the serfs, and the programme which he made out for the work was copied almost exactly in the decree of 1861. His principal writings are *History of the Civil Procedure and of the Organization of the Courts in Russia from the Twelfth Century to the Present Time* (1843). *General Sketch of the Juridical Development of Russia before Peter the Great* (1847); *Problems of Psychology* (1875); and essays on various other subjects. He died May 3, 1886.

KAWI OR KAVL, ancient language. See JAVA, Vol. XIII, p. 608.

Vol. 3—31

KAYE, JOHN, an English Episcopal bishop; born at Hammersmith, Dec. 23, 1783; was educated at Cambridge, and for several years was regius professor of divinity there. In 1820 he became bishop of Bristol, and in 1827 bishop of Lincoln. Among his works are *Writings and Opinions of Clement of Alexandria* (1835); *Writings and Opinions of Justin Martyr* (1836); *Government of the Church During the First Three Centuries* (1855); besides many treatises and shorter articles. He died at Riseholme, Feb. 18, 1853.

KEA, a parrot. One of group NESTOR; q. v., Vol. XVII, p. 354.

KEANE, JOHN JOSEPH, an American Catholic bishop; born in Ballyshannon, County Donegal, Ireland, Sept. 12, 1839. The family removed to the United States in 1846. He was educated for the priesthood in Baltimore, at St. Mary's Seminary. After his ordination in 1866 he was assigned to St. Patrick's Church, Washington, District of Columbia, as assistant rector; in 1878 was appointed bishop of Richmond, and in 1886 rector of the Catholic University of America, at Washington. He was made bishop at Ajasso, a titular see, in 1888, and from that time until October, 1896, when he was removed by a papal decree, devoted himself to the upbuilding of a great university. He was offered the choice of his field of labor, but preferred to retire from active priestly duties.

KEARNEY, a city and the capital of Buffalo County, southern central Nebraska, in the Platte River valley, and on the Union Pacific, the Burlington and Missouri Valley, and the Kearney and Black Hills railroads, 125 miles W. of Lincoln. It is in a fertile and well-watered farming and grazing region, and obtains abundant water-power by a canal thirteen miles long, from the Platte River. It has flour-mills, a foundry and machine-shop, brickyards, canning, pickling and cracker factories, and is an important grain-shipping point. Pop. 1890, 8,074; 1900, 5,634.

KEARNEY, LAWRENCE, a United States naval officer; born at Perth Amboy, New Jersey, Nov. 30, 1789. He entered the navy as a midshipman in 1807, serving on board the frigates *Constitution* and *President*, and in 1813 had become a lieutenant. During the War of 1812 he was employed in the defense of the coast of South Carolina, and later cleared the West Indies and Gulf coast of pirates. Subsequently he was active in the suppression of opium-smuggling. He then held various shore appointments, including the command of the New York station, and the presidency of one of the naval boards of inquiry. In 1867 he was made commodore on the retired list. He died at his native place, Nov. 29, 1868.

KEARNY, PHILIP, an American soldier; born in New York City, June 2, 1815. He entered the army in 1837, and in 1839 went to Europe to examine the tactics of the French cavalry service. He entered the cavalry school at Saumur, and then enlisted in the French army, attracting the attention of the government by his daring exploits during the campaign in Algeria. In 1840 he returned to the United States, was

made aid to General Alexander Macomb, and was attached to the staff of General Winfield Scott from 1841 to 1845.



GENERAL PHILIP KEARNY.

In 1846 he was made a captain, and during the assault upon the City of Mexico he lost an arm. He was in California during the gold discoveries, and took part in the warfare with the Oregon Indians. In 1859 he returned to France and served with his old comrades at Magenta and Solferino, being decorated with the cross of the Legion of Honor. In 1861 he re-enlisted in the United States army, was promoted major-general, and was killed at Chantilly, Sept. 1, 1862. General Scott referred to General Kearny as "the bravest man I ever knew, and the most perfect soldier."

KEARNY, STEPHEN WATTS, an American soldier; born in Newark, New Jersey, Aug. 30, 1794. At the beginning of the War of 1812 he enlisted in the Thirteenth Infantry as a lieutenant, and the following year was made a captain. In 1846 he became a brigadier-general, and at the outbreak of the Mexican War took possession of New Mexico. In 1847 he was governor of California, in 1848 of Vera Cruz, and the same year of the City of Mexico. He wrote a *Manual for the Exercise and Manœuvring of United States Dragoons* (1837); *Laws for the Government Territory of New Mexico* (1846). He died in St. Louis, Oct. 31, 1848.

KEARSARGE, MOUNT, a prominent mountain in Carroll County, New Hampshire, five miles N. of the village of North Conway. Height, about 3,250 feet. It is also written Kiarsarge, and is the favorite excursion point of the district. The view from the summit—Moosilauke and Lafayette, the Presidential Range, Goose Eye, the peaks toward Lake Umbagog, Portland, Sebago Lake,

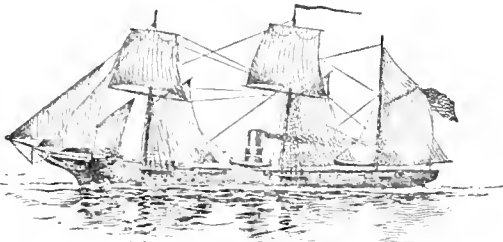

UNITED STATES CORVETTE "KEARSARGE."

Monadnock and the other Kearsarge, is particularly fine.—The famous warship which sunk the *Alabama* received its name from this mountain, or, as some claim, from a mountain of similar name in Merrimac County, New Hampshire, 21 miles N.W. of Concord, which has a height of about 2,950 feet. Both mountains have formed the subject of American poets' praises, and the name was rendered famous by the United States wooden

three masted steamer *Kearsarge*, launched at Portsmouth, New Hampshire, October 5, 1861. The dimensions of the *Kearsarge* were: Length between perpendiculars, 198.5 feet; breadth of beam, 33 feet; draft, 15 feet 9 inches; registered tonnage, 1,031; two engines of 400 horse-power each. Her armament consisted of four 32-pounders, two 11-inch rifles, one 12-pounder howitzer, and one 30-pounder rifle. She carried 163 officers and men, and was commanded by Captain John A. Winslow. On Sunday, June 19, 1864, the *Kearsarge* fought the Confederate cruiser *Alabama* off the port of Cherbourg, France, and, after a brief battle, sank the privateer, which had destroyed the American merchant marine. The battle forms the subject of many spirited and warlike poems, especially one by G. H. Boker, and another by Dr. Mitchell, wherein he apostrophizes the mountain:

"Stirred one grand rocky steep,  
When rode her sons as victors,  
Lords of the lonely deep."

On Feb. 2, 1894, the *Kearsarge* was wrecked on Roncador Reef, in the Caribbean Sea. The officers and crew were saved, but the remains of the vessel were burned by natives before the arrival of a wrecking party.

KEATING, JOHN M., an American gynæcologist; born in Philadelphia, April 30, 1852; received his education at the University of Pennsylvania and Philadelphia Polytechnic; later became a medical lecturer in the University of Pennsylvania and professor of the principles and practice of medicine in the Woman's Medical College. He traveled in the East with General Grant, and after his return was appointed medical director of the Pennsylvania Mutual Life Insurance Company. He published *Cyclopædia of the Diseases of Children; Diseases of the Heart and Circulation in Childhood; With General Grant in the East* (1880); *How to Examine for Life Insurance*; and various other medical works, mostly in reference to children.

KEEL. See SHIP-BUILDING, Vol. XXI, p. 819.

KEELEY, LESLIE E., an American physician; born in St. Lawrence County, New York, in 1836; removed in early life to Michigan; in 1863 graduated from Rush Medical College, Chicago; received the honorary degree of LL.D. from the University of St. Louis; was a surgeon in the Civil War; located in general practice at Dwight, Illinois, in 1866. Dr. Keeley gained much notoriety on account of the methods in his treatment of alcoholism and narcotism. Regarding inebriety a disease rather than a vice, his treatment was essentially therapeutic, though moral and social agencies are auxiliary means. His formulas were not given to the medical profession, which fact was regarded as a violation of professional ethics. His system was used in the United States army, in the national homes for disabled volunteer soldiers, among the Indians, and in state charitable institutions. His book, *The Non-Hereditary of Inebriety*, was published in 1896. The Keeley treatment is also known as the "gold cure" be-

cause of the use of a chloride of gold as the essential drug in the treatment. The method was used extensively throughout the United States in various proprietary institutes known as Keeley Institutes, the graduates of which have organized themselves into a national society called the Keeley League.

KEELHAULING, a punishment used in the navy during the seventeenth and eighteenth centuries. The culprit was suspended from one yard-arm, dropped into the water, and hauled beneath the keel to the other side. Keelhauling was practiced on an Egyptian corvette as recently as August, 1882.

KEEN, WILLIAM WILLIAMS, an American physician; born in Philadelphia, Jan. 19, 1837. From 1862 to 1864 he was a surgeon in the United States army, and after studying two years in Europe, settled in Philadelphia, Pennsylvania, where he lectured for nine years in Jefferson Medical College, also conducting the Philadelphia School of Anatomy. In 1884 he was made professor of surgery in the Woman's Medical College of Philadelphia. He gave most of his attention to surgery of the nervous system, and was the originator of several operations, among them the draining of the lateral cerebral ventricles, first performed by him in 1888. He edited a number of text-books on anatomy; among them, *Heath's Practical Anatomy* (1870); the American edition of *Gray's Anatomy*, and *The American Text-Book of Surgery* (1892).

KEENE, a city of southwestern New Hampshire, the capital of Cheshire County, on the Ashuelot River, 50 miles W.S.W. of Concord, and on the Fitchburg and the Boston and Maine railroads. Keene is a beautiful, well-built city, with wide, shaded streets, with picturesque surroundings; has a fine central square, from which radiate the five principal streets, and in which is a handsome monument to the memory of soldiers who fell in the Civil War. It contains a public library with 10,000 volumes. An abundant water-supply is derived from a lake three miles distant. Keene is the business center of a fertile agricultural region. It has manufactories of furniture, shoes, flannel, toys, glue, carriages, sleighs, sashes and blinds, and has foundries, and the repair-shops of the Fitchburg railroad. Population 1890, 7,446; 1900, 9,165.

KEENE, CHARLES SAMUEL, an English illustrator; born in Hornsey, England, Aug. 10, 1823. He was educated in his own town, and, following his natural bent, went to work for a firm of wood-engravers, for whom he drew engravings for several books, including *Robinson Crusoe*. He did illustrations for various periodicals until he began work on *Punch* in 1851. In a short time he became one of the leading and most popular of artists on that paper. His sketches were in pen and ink, and caught the humorous side of every-day incidents. He illustrated a number of books, such as Douglas Jerrold's *Mrs. Caudle's Curtain Lectures*; Mark Lemon's *Number Nip*; and Charles Reade's *He Would*

*be a Gentleman*. He died in London, Jan. 4, 1891.

KEENE, LAURA, the stage name of an English actress, whose maiden name was Mary Moss; born in Chelsea, London, 1820. Her first appearance was at the Lyceum in 1845. She married Henry W. Taylor in 1847 and John Lutz in 1857; traveled successfully through the United States and Australia; was manager of a theater in New York City for some years; in 1858 produced *Our American Cousins*, with Joseph Jefferson as Asa Trenchard and Edward A. Sothern as Lord Dundreary. It was while present at one of her representations of the above in Ford's Theater, Washington, that Abraham Lincoln was assassinated in 1865. As a play-writer she was not successful. She died at Montclair, New Jersey, Nov. 4, 1873.

KEESEVILLE, a post village of Essex and Clinton counties, northeastern New York, lying on both sides of the Au Sable River, four miles W. of Lake Champlain, on the Keeseville, Au Sable Chasm and Lake Champlain railroad, which connects with the Delaware and Hudson. The river is spanned here by three bridges. The water-power is abundant, and the leading industry is the manufacture of iron and steel; flour and woolen-mills, furniture, nail, harness and wagon factories are also located here. Population 1890, 2,103; 1900, 2,110.

KEEWATIN, a district of the Northwest Territories of Canada, north of Manitoba, extending to the Arctic archipelago, between 95° 8' and 100° 8' W. long. It contains many large rivers and lakes, draining into Hudson Bay. The country is rough and sterile, with occasional forests, but rich in metals. It has an area of about 498,000 square miles. It was created in 1876, and put under the jurisdiction of the lieutenant-governor of Manitoba. A portion of Manitoba was added in 1883. Its population is very small, consisting of a few Icelanders and Indians.

KEICHO, same as HANOI. See TONG-KING, Vol. XXIII, p. 440.

KEIGHTLEY, THOMAS, an Irish author; born in Dublin, Ireland, October, 1789. He was educated at Trinity College, Dublin, and in 1824 settled in England to a life of letters. His histories of *Rome* (1836), *Greece* (1835), and *England* (1839), long held their place as school manuals. He also wrote *Fairy Mythology* (1850) and *Life, Writings and Opinions of Milton* (1859). He died at Erith, Kent, England, Nov. 4, 1872.

KEITH, GEORGE, an English clergyman; born in Aberdeen, Scotland, in 1638. In 1664 he became a Quaker, and in 1684 emigrated to America. In 1689 he took charge of a Friends' school in Philadelphia, but left it soon afterward to travel in New England. He then formed a society of his own, known as the Christian or Baptist Quakers, or Keithians; but again becoming dissatisfied, he was ordained in the Church of England. In 1702 he was sent on a mission to New Jersey and Pennsylvania, and seven hundred Quakers received baptism in the Episcopal Church, under his influence. Subsequently he became rector of Edburton, Sussex, England, where he died, March 27, 1716. He was

the author of *Journal of Travels from New Hampshire to Caratuck* (1706); *New Theory of Longitude* (1709); and several theological works.

KEITH, GEORGE KEITH-ELPHINSTONE, VISCOUNT, a British admiral; born near Stirling, Scotland, Jan. 7, 1746. Entering the navy in boyhood, he saw service in various parts of the world, and distinguished himself in numerous engagements in the American war and the French wars. He was in command of the expedition in 1795-97 which took possession of Cape Colony, in South Africa, Ceylon, Cochin, Malacca, and the Molucca Islands; had command of the fleet which landed Abercrombie's army in Aboukir Bay in 1801, and of the channel fleet which prevented Napoleon from crossing to England. He died March 10, 1823, in Tullialan, Scotland.

KEITHSBURG, a city of Mercer County, northwestern Illinois, on the Mississippi River, on the Chicago, Burlington and Quincy and the Cleveland, Cincinnati, Chicago and St. Louis railroads, 30 miles W.N.W. of Galesburg. It has flouring-mills, a carriage factory, and is the center of an agricultural region. Population 1900, 1,566.

KELLER, GOTTFRIED, a Swiss poet and novelist; born at Zurich, July 19, 1819. He at first took up painting, but abandoned it for literature, which he studied at Heidelberg and Berlin. From 1861 to 1876 he was secretary of state of his native canton. His principal works are *Der Grüne Heinrich* (1854); *Romeo und Julie auf Dem Dorfe*; *Kleider Machen Leute*; *Sieben Legenden* (1872); *Züricher Novellen* (1876); and *Martin Salander* (1886). He died July 16, 1890.

KELLEY, EDGAR STILLMAN, an American composer; born at Sparta, Wisconsin, April 14, 1857. He studied with local teachers, and then went to Stuttgart, Germany. On his return he settled first in San Francisco, and afterward in New York, where he devoted himself to teaching and composing. His first important work was incidental music to *Macbeth*. Among his later works is a successful opera called *Puritana* (1892).

KELLEY, WILLIAM DARRAH, an American statesman; born in Philadelphia, April 12, 1814; practiced law and became (1845-46) attorney-general of Pennsylvania. From 1846 to 1856 he was judge of the common pleas. Originally a Democrat, he joined the Republican party at its formation, and became an ardent advocate of abolition. From 1862 to the end of 1889 he represented his district in Congress, and was serving his fifteenth term at the time of his death, Jan. 9, 1890, being then the senior member of the House in continuous service. He was a strong protectionist, and from his frequent speeches upon the tariff in its relation to the iron industry, was popularly known as "Pig-Iron Kelley." He published *Letters on Industrial and Financial Questions* (1872); and *Letters from Europe* (1887).

KELLOGG, CLARA LOUISE. See STRAKOSCH, MRS. PAUL, in these Supplements.

KELLOGG, DAY OTIS, an American litterateur, was born March 31, 1837, at Troy, New York; was graduated from Hobart College, New York, in 1857; studied for two years at the Alexandria Theological

Seminary, in Virginia. In 1861 he took orders in the Episcopal Church, and from then until 1870 had charge of churches in Bridgeport, Connecticut, and Philadelphia, and of Grace Church at Providence, Rhode Island. He was professor of English literature and history in the University of Kansas till 1874, when that institution conferred on him the doctorate of divinity. He then returned to Philadelphia as the rector of one of his former parishes. He was a founder and the first secretary of the Philadelphia Charity Organization Society, in 1878. In 1880 he removed to Vineland, New Jersey, abandoning the ministry for literary pursuits. He was on the editorial staff of the *Providence Evening Press*, the *Philadelphia Press*, and a contributor to the *Penn Monthly*, the *American* (Philadelphia), and the *Atlantic Monthly*, and other periodicals. He was on the editorial staff of the *Standard Dictionary*, and the compiler of an index to the ENCYCLOPEDIA BRITANNICA, 9th ed., and the editor of the Supplements to the Werner and Sommerville editions of the same ENCYCLOPEDIA.

KELOID OR CHELOID, a skin disease. The disease is apparently of two kinds, the first being somewhat like a tumor, and forms often in the scar of a burn. It is incurable, and likely to return after excision. The second is a more general skin disease, and in hot weather spreads over the body, causing itching. It can be cured by certain washes, and is more common among negroes than white people.

KELUNG OR KILUNG, seaport. See FORMOSA, Vol. IX, pp. 416, 417.

KELVIN, WILLIAM THOMSON, BARON, a British physicist and mathematician, was born in Belfast, June 25, 1824. His father, Dr. James Thomson, was lecturer on mathematics at the Royal Academical Institute, Belfast, but removed to Glasgow on his appointment to a professorship in the university of that city. Here young Thomson finished the university course, but afterward he proceeded to Cambridge, where he graduated in 1845 as second wrangler, the bent of his mind being toward science.



LORD KELVIN.

In 1846 he was appointed professor of natural philosophy at Glasgow University, and held the chair until 1896, when he retired, after celebrating the fiftieth anniversary of his incumbency of the office. The jubilee demonstration was participated in by hundreds of the chief representatives of science from nearly every quarter of the globe. Early in his career Mr. Thomson became editor of the *Cambridge and Dublin Mathematical Journal*, and in its pages appeared many of his papers on the mathematical theory of electricity. In 1848 he published a treatise on the *Distribution of Electricity on Spherical Conductors*, and in 1855 issued the Bakerian lecture, on the *Electrodynamic Properties of Metals*. Pa-

pers on electrostatics and magnetism appeared at frequent intervals from his pen, and his researches led him to invent an instrument for electrostatic measurement, and one, the quadrant electrometer, which is employed for all manner of electric testing in telegraph-construction and for the registration of atmospheric electricity at Kew and other observatories. To the science of magnetism he made other and important additions; but it is in the investigation of the nature of heat that his extraordinary power of scientific analysis is seen to the greatest advantage. The following are some of his more important papers: *On Thermal Effects of Fluids in Motion*; *The Mathematical Theory of Elasticity*; *The Rigidity of the Earth*; *The Determination of a Ship's Place at Sea from Observation of Altitudes*; and *Approach by Vibration*. On the successful completion of the Atlantic cable in 1866, Professor Thomson was knighted, and in 1892 he was made a baron in the peerage of the United Kingdom. Lord Kelvin had much to do with the laying of submarine cables, the efficiency of which was increased by his mirror-galvanometer and siphon-recorder, and was the inventor of an invaluable apparatus for taking deep-sea soundings with a steel pianoforte-wire instead of by the ordinary lead-line. Later Lord Kelvin became identified with the introduction into Britain of the electric light for public and domestic purposes. He is the author, conjointly with Professor Tait of Edinburgh, of a treatise on *Natural Philosophy* (1867-79), and has published a collection of *Popular Lectures and Addresses* (1890), dealing with the *Constitution of Matter*, with *Navigatorial Affairs*, and on *Geology and General Physics*. His theory of vortex-motion has thus far been found consistent with the known properties of matter. He is also one of the chief authorities in the Old World on heat, including electricity and magnetism, and on the dynamical theory of gases. The article on ELASTICITY (see Vol. VII, pp. 796-825), in this ENCYCLOPÆDIA, is from Lord Kelvin's pen.

**KELVIN CURRENT-BALANCES.** See ELECTRICITY, § 54, in these Supplements.

**KEMBLE, FRANCES ANNE**, an Anglo-American actress and Shakespearean reader; born in London, Nov. 27, 1809; descended from a long ancestry of actors and actresses. In 1829 she made her *début* at Covent Garden, London, and in 1832 went to the United States with her father, Charles Kemble, where she met with great success. In 1834 she married Pierce Butler of Philadelphia, and retired from the stage; but, the marriage being unhappy, they obtained a divorce,



FANNIE KEMBLE.

and Mrs. Butler went to live in Lenox, Massachusetts. In 1849 she came before the public at Philadelphia in her first course of Shakespearean readings, and these entertainments afterward were re-

peated in many cities of America and Europe. "Fanny" Kemble also wrote *Francis the First*, a drama (1832); *Journal* (1835); *The Star of Seville*, a drama (1837); *Poems* (1844); *A Year of Consolation* (1847); *Plays* (1863); *Journal of a Residence on a Georgia Plantation* (1863); *Records of a Girlhood* (1878); *Records of Later Life* (1882); *Notes on Some of Shakespeare's Plays* (1882); and *Further Records*. She died in London, Jan. 16, 1893.

**KEMÉNY, SIEGMUND, BARON**, a Hungarian politician and poet; born in Magyar-Kapud, Transylvania, in 1816; entered politics, and in 1841 became editor of the *Erdélyi Híradó* and member of the Transylvania Parliament. In 1848 he removed to Budapest, becoming a member of the Hungarian National Assembly, and in 1849 minister of the interior. After the overthrow of Vilagos he became an advocate of union with Austria. He published *Man and Wife*; *Love and Vanity*; and other biographical romances. In 1870 his critical works were published under the title *Studies by Kemény*. He died at Pussta Kamaras, December, 1875.

**KEMPF, REAR-ADMIRAL LOUIS** (U. S. N.), late commandant Navy Yard, Mare Island, and at present (1900) on active duty in Chinese waters, was born near Belleville, Ill., Oct. 11, 1841. He entered the Naval Academy in 1861, served on the *Vandalia* in the blockade off Charleston; appointed acting master and took part in the engagement at Port Royal, S. C., Nov. 7, 1861; afterwards served on the flagship *Wabash* and other vessels on the Atlantic and Gulf Coast to the close of the Civil War. In 1862 he took part in the bombardment of Sewell's Point, Va., and in the re-occupation of Norfolk, Va. Was promoted commander March, 1876, captain in 1891 (in command of receiving ship *Independence*), and rear-admiral in 1890.

**KENAI INDIANS.** See INDIANS, Vol. XII, 827.

**KENDAL, MRS. MARGARET BRUNTON**, actress. See GRIMSTON, MRS. WILLIAM HUNTER, in these Supplements.

**KENDAL, WILLIAM HUNTER.** See GRIMSTON, WILLIAM HUNTER, in these Supplements.

**KENDALL, AMOS**, an American statesman; born in Dunstable, Massachusetts, Aug. 16, 1789. He was educated at Dartmouth, graduating in 1811; studied law, removed to Lexington, Kentucky, and was for a short time tutor in the family of Henry Clay. He then was appointed postmaster of Georgetown, Kentucky, edited the local paper, and in 1816 became co-editor of the *Argus of Western America*, a Democratic newspaper published at Frankfort, Kentucky. In 1824 he supported the nomination of General Andrew Jackson for the Presidency, and in 1829 was appointed fourth auditor of the United States Treasury; in 1835 he was appointed Postmaster-General. President Van Buren retained him in office, from which he retired in 1840. In 1845 he was connected with Professor Morse in the ownership of telegraphic patents, by which he became wealthy. He was the originator of the Washington Deaf and Dumb Asylum, besides contributing largely to several other charities. He died in Washington, District of Columbia, Nov. 11, 1869.

**KENDALLVILLE**, a city of Noble County, northeastern Indiana, on the Grand Rapids and Indiana and the Lake Shore and Michigan Southern railroads, 27 miles N. of Fort Wayne. It is in a rich grain-raising district and has the East Indiana Fair Grounds. It has manufactures of iron-work, flour, lumber, wind-mills, refrigerators, pumps, clothes-racks, bee-keepers' supplies and barrels and tubs. It is supplied with water and electric lights. Population 1890, 2,960; 1900, 3,354.

**KENEALY**, EDWARD VAUGHAN HYDE, an Irish barrister, journalist and author, noted for his vehement and injudicious defense of the Tichborne claimant, Arthur Orton (see **TICHBORNE**, in these Supplements). He was born in Cork in 1819, was educated at Trinity College, Dublin, and as a fluent linguist, with a remarkable knowledge of thirteen languages, contributed to several magazines, and published *Brallaghan* (1845), and *Goethe*, a new pantomime (1850), both brilliant and entertaining works. In 1873 he acted as counsel for the notorious Arthur Orton in the Tichborne case, and was, if possible, the greatest dupe of this impostor. In defending Orton upon the trial for perjury, Kenealy mistook every function of the lawyer. Instead of contenting himself with commenting upon the improbabilities of the case for the crown, and endeavoring to secure his client's acquittal, he foolishly set up that which was not in issue, and endeavored by every means to prove, in spite of the previous adverse verdict, that his client was the real Sir Roger Tichborne. In the opinion of eminent jurists of that day, his attacks upon witnesses and behavior toward the court were discreditable to the profession to which he belonged, while the possibilities of an acquittal for his client, had the defense been properly handled, were more than considerable, especially after the dowager Lady Tichborne's identification of the impostor as her son. Orton was convicted, and Kenealy started a violent and undignified crusade in his behalf, in the columns of a paper, called *The Englishman*, which he published for a brief period. He was disbarred, but obtained a seat in Parliament in 1875, and died April 16, 1880, believing to the last in the righteousness of the impostor's cause.

**KENESAW** OR **KENNESAW MOUNTAIN**, a double-peaked eminence, about 1,200 feet high, lying directly north and northwest of the city of Marietta, in Cobb County, Georgia, and sending out a spur for several miles in a northeasterly direction. It is 25 miles N.W. of Atlanta. With Lost Mountain it forms the base of a triangle, of which Pine Mountain is the apex. Here, in June, 1864, the Confederate general, Joseph E. Johnston, made a stand in his retreat before Sherman and the Union soldiery, who were forcing the way to Atlanta. The rebel front was about four miles long, strongly fortified, and more than aided by the natural advantages of a mountain stronghold. Sherman's first object was to break the rebel line between Kenesaw and Pine mountains. On the 14th, General Polk, the Confederate commander on Pine Mountain, was killed by a Union shell. The Union forces made repeated attacks on the Confederate positions, and

outflanking them, compelled Johnston to abandon his works on the night of July 2d and fall back to the Chattahoochee. The Union loss in the attacks on Kenesaw Mountain approximated 7,500 men; that of the Confederate troops, who fought behind abatis and log parapets in mountain strongholds, probably did not exceed 1,000 killed and 2,000 taken prisoners. Johnston was relieved from his command by President Davis, and General Hood placed in command of the Confederate army of Tennessee.

**KENITES** OR **KENIZZITES**. See **PALESTINE**, Vol. XVIII, p. 175.

**KENNAN**, GEORGE, an American traveler and author; born at Norwalk, Huron County, Ohio, Feb. 16, 1845; was educated in the public schools, studied telegraphy, and in 1864 was commissioned by the Russo-American Telegraph Company to superintend the construction of lines in Siberia; spent three years in exploration, location of routes, and construction of a telegraph line between the Sea of Okhotsk and Bering Strait. He returned to America in 1868, and in 1885-86, accompanied by the artist George A. Frost, again journeyed through eastern Russia, exploring the region of the Altai, and visiting the convict prisons and mines of Siberia. His extensive observations were published in a journal of travel, *Tent-Life in Siberia* (1870), and more particularly in a series of illustrated articles in the *Century Magazine*, (1887-90), afterward collected in book-form, *Siberia and the Exile System* (1891). Mr. Kennan's graphic narrative created a profound impression throughout Christendom, his startling revelations of misery and the brutality of Russian officials causing the proscription of the above magazine in the empire and the blacklisting of foreign journals commenting upon the subject.



GEORGE KENNAN.

**KENNEBEC**, a river of Maine, rises in Moosehead Lake, in Somerset County, and, passing Augusta, runs generally south to the Atlantic Ocean. Its length is over 150 miles. It is navigable for large vessels to Bath, 12 miles, and for steamers beyond Augusta. In its course it falls 1,000 feet.

**KENNEBUNK**, a town of York County, southwestern Maine, on the Boston and Maine railroad, and on the Kennebunk River, 25 miles S.W. of Portland. The town also extends to the coast, where it has a fine beach. It has several hotels, two public libraries, and is quite a summer resort. It manufactures leatheroid, leather-board, boots, shoes, lumber and twine, and has a considerable coasting trade. Population 1890, 3,172; 1900, 3,228.

**KENNEDY**, JOHN PENDLETON, author and statesman; born in Baltimore, Md., Oct. 25, 1795; graduated at Baltimore College in 1812; in 1814 took part in the defense of Bladensburg; studied law and was admitted to practice in 1814. In 1820-23 he was



a member of the state legislature; in 1838 he was elected to Congress as a Whig; and in 1840 was a Presidential elector on the Harrison ticket. In 1852 he was appointed Secretary of the Navy, and as such zealously pushed forward Commodore Perry's Japan expedition and Dr. Kane's second polar voyage. During the Civil War he supported the cause of the Union. He is best known as the author of *Swallow Barn* (1832); *Horseshoe Robinson, a Tale of Tory Ascendency* (1835); *Rob of the Bowl* (1838); *Annals of Quodlibet* (1840); and *A Defense of the Whigs* (1844). Died at Newport, R. I., Aug. 18, 1870.

**KENNETT SQUARE**, a borough of Chester Co., Pa., 30 miles S. W. of Philadelphia; was founded before 1760; has foundries and factories of road-scrappers and rollers, stone-crushers, engines, phosphates, and pottery. The British troops rallied here before the battle of Brandywine, in 1777. Pop. 1900, 1,516.

**KENOSHA**, a city, capital of Kenosha Co., Wis., on Lake Michigan, 32 miles S. of Milwaukee; has an excellent harbor, and a growing lake commerce; also parks, two water-cure establishments, and factories of carriages, wagons, furniture, and other wooden articles. Pop. 1890, 6,532; 1900, 11,606.

**KENRICK, FRANCIS PATRICK**, an American Catholic archbishop; born in Dublin, Ireland, Dec. 3, 1797; educated at Rome, and entered the priesthood in 1821. Later he was sent to America, and became head of the Roman Catholic Seminary at Bardstown, Ky. In 1830 he was made bishop of Arath *in partibus*; in 1842 bishop of Philadelphia; in 1851 archbishop of Baltimore; and in 1859 honorary primate of the United States. In 1832 he founded St. Charles Borromeo Seminary, Philadelphia. He wrote *Theologica Dogmatica* (1840); *Theologica Moralis* (1843); and was engaged upon revisions of the Douai English Bible for several years before his death. Died in Baltimore, July 8, 1863.

**KENRICK, PETER RICHARD**, an American Roman Catholic archbishop; born in Dublin Aug. 17, 1806; educated at Maynooth, and ordained a priest in Ireland, but soon afterward went to Philadelphia, where his brother, Francis Patrick Kenrick (q. v.), was coadjutor to the bishop. Here he edited the *Catholic Herald* for several years, and published various works, original and translated. He was also made vicar-general of the diocese. In 1841 Bishop Rosati of St. Louis requested his nomination as his coadjutor with the right of succession. He was consecrated bishop of Drasa *in partibus*, and coadjutor of St. Louis, Nov. 30, 1841. In 1843, on the death of Bishop Rosati, he became bishop of St. Louis, and in 1847 the first archbishop of that city. He established a hospital, an orphanage, two convents, and numerous schools and charitable institutions. Died in St. Louis, March 4, 1896.

**KENSETT, JOHN FREDERICK**, an American painter; born in Cheshire, Conn., March 22, 1816. In 1840 he went to England, where he became employed as an engraver and studied the art of design. In 1845 he exhibited at the Royal Academy of London his earliest painting, *Windsor Castle*. He went to Rome, where he spent two years, and completed a number of Italian landscapes. In 1848 he returned to New York city, and his *View on the Arno* and

*Shrine*, exhibited at the National Academy in New York city in that year, established his reputation. In 1849 he was made an academician, and in 1859 a member of the decoration commission of the Capitol at Washington. His best works are in American landscapes. Died in New York city, Dec. 14, 1872.

**KENT**, a village of Portage Co., Ohio, on the Cuyahoga river, eight miles N. E. of Akron; has good water power, and manufactures locks, furniture, carriages, and a fine window-glass made from a white sand-rock found in the vicinity, and has railroad machine-shops. Population 1900, 4,541.

**KENT, JACOB FORD**, American army officer, born in Pennsylvania, Sept. 14, 1836. In 1856 he was appointed from that state as cadet to the Military Academy; he graduated May 6, 1861, and on the same date entered the regular army as second lieutenant of the Third Infantry, and was made lieutenant July 31 following. In the same year he served in the first Bull Run campaign, and in September, 1862, was taken prisoner, but was exchanged soon after, and served in the Fredericksburg and Chancellorsville campaigns. On Jan. 1, 1863, he was made lieutenant-colonel and assistant inspector-general of volunteers, and was brevetted major for gallant and meritorious services in the battle of Marye's Heights, Va. On January 8, 1864, he was promoted captain, and in the same year was brevetted lieutenant-colonel for gallant services at the battle of Spotsylvania; in October, 1864, was brevetted colonel of the volunteers for faithful services in the field in the campaign before Richmond. From the close of the war till 1877 he served on frontier duty in various departments, and from 1877 to 1885 he served in Montana. In July, 1885, he was made major of the 4th Infantry, and up till 1887 was stationed at Fort Omaha, and in 1887-94 at Spokane, Wash. In 1891 he was made lieutenant-colonel of the 18th Infantry; and on April 25, 1895, colonel of the 24th Infantry, with headquarters at Fort Douglas, Utah. After the war with Spain broke out he was made major-general of volunteers and commander of the First Division of General Shafter's army at Santiago, and distinguished himself at the battles at San Juan, near there, July 1-3, 1898.

**KENT, WILLIAM CHARLES MARK**, an English editor; born in London, Nov. 3, 1823. From an early age he adopted literature as a profession, and produced a number of volumes of poems, essays, and stories. He was for 25 years editor of *The Sun*, and for seven years (1874-81) editor of the Roman Catholic publication, *The Weekly Register*. He edited the works of Lamb, Burns, Moore, and the first Lord Lytton, and published some theological works, of which *Corona Catholica* is the best known. Among his works are *Dark Ages, by an Oscotian* (1847); *The Gladstone Government, by a Templar* (1869); *The Humour and Pathos of Charles Dickens* (1884); and he contributed the articles on DEAN ALFORD and LORD DALLING to this ENCYCLOPÆDIA.

**KENTISH RAG**, the local name given to a grayish blue limestone which occurs at Hythe and other places on the coast of Kent, England, in the lower greensand measures; is sometimes sixty to eighty feet thick.

**KENT ISLAND**, the largest island in Ches-

peake Bay, belonging to Queen Anne County, Maryland, extending from  $38^{\circ} 51'$  to  $39^{\circ} 3'$  N. lat. It was colonized in 1631 by Claiborne, who here established the first settlement in the state. The island is fifteen miles long, and has a very fertile soil and important oyster-fisheries. Population 1890, 2,230.

KENTON, a city and the capital of Hardin County, northwestern central Ohio, situated in the center of the state, in a farming district, on the Scioto River, and on the Cleveland, Cincinnati, Chicago and St. Louis and the Toledo and Ohio Central railroads, 28 miles E. of Lima. Lumbering and farming are the industries of the surrounding region. Kenton manufactures straw-board, bee-keepers' supplies, has the largest iron-fence factory in the United States, and saw and planing mills. Population 1890, 5,557; 1900, 6,852.

KENTON, SIMON, an American pioneer; born in Fauquier County, Virginia, April 3, 1755. At the age of 16 he had an affray arising from a love affair, and, believing that he had killed his adversary, fled from Virginia to Kentucky, where he ranged the country as a spy against the Indians until 1778, when he was captured by the Indians, but escaped some months afterward, and during the invasion of Kentucky by the British and Indians, led a company and aided in driving out the invaders. In 1782 he again commanded a company, and then, learning that the man he supposed he had killed was still living, visited his old home, but soon afterward re-entered the army. In 1793 he was major of a battalion of Kentucky volunteers; in 1805 became a brigadier-general of Ohio militia, and fought at the battle of the Thames in 1813. In 1824, having lost his vast possessions of land through the invasion of pioneers, he appeared in Frankfort, Kentucky, before the legislature, in tattered garments, petitioning for relief, which was granted, and a pension of \$240 procured for him from Congress. He died in Logan County, Ohio, April 29, 1836.

KENTUCKY had a population of 1,858,635 in 1890, of whom 276,454 lived in the seven cities of



STATE SEAL OF KENTUCKY.

the state, constituting 14.87 per cent of the entire number of inhabitants. The gain for the ten years 1880 to 1890 was 12.73 per cent. The number of people to the square mile was 46.47, a density greater than that of any other of the south-central group of states. The relative proportions of males to females was 942,758 of the former and 915,887 of the latter. The population of the state in 1900 was 2,147,174. The number of negroes in 1890 was 268,071, a decrease of 3,380 since 1880.

Kentucky stood the highest among her group of states in the item of average annual milk-production per cow, the average being 325.08 gallons in Kentucky, as compared with 77.03 gallons in

Louisiana. In the production of hemp Kentucky leads the states, with 23,468 acres devoted to its culture, against 25,054 acres, the entire area in the United States, thus giving the state 92 per cent of the total acreage. The value of the crop for the statistical year 1889 was \$1,102,602, of which amount the farmers of Kentucky received \$1,045,081. The census returns also showed Kentucky to be first in the production of tobacco, over one half of the entire area devoted to its cultivation in the United States being in the states of Kentucky and Virginia, the former showing an increase of 48,467 acres since the census of 1880, the latter showing a decrease of 30,212 acres during the same period. The number of acres devoted to tobacco in 1889 was 274,587, or 39.49 per cent of the entire area, while the yield was 221,880,303 pounds, or 45.44 per cent of the crop of the United States. In addition to the products mentioned, there are raised broom-corn, potatoes, beans, buckwheat, hay, and grass-seeds. The number of farms at the date of the taking of the census was 179,264, the average size 119 acres, and the total area 21,412,229 acres, of which 44.80 per cent was unimproved. The total value of lands, buildings, fences, machinery and implements and live-stock was \$428,170,266. The estimated value of the farm products for the year was \$65,948,485; the number of horses, 401,356; the number of mules, 151,649; neat cattle, 1,066,091; swine, 2,036,746; and sheep, 937,124. The yield of wool was 2,777,533 pounds.

The manufacturing statistics compiled for the decennial census of 1890 show the number of establishments to have been 7,745; the amount of capital invested, \$79,811,980; the number of persons employed, 65,579; to whom \$27,761,746 were paid as wages; and the value of all products, \$126,719,857. The principal industry was distilling, the number of establishments being 126; the capital invested, \$10,966,210; the persons employed, 1,992; and the value of the product, \$15,159,648. The manufacture of tobacco in its different forms yielded a return in excess of \$11,000,000. Flouring and grist-mill products returned \$9,681,259, and foundry and machine-shop products, \$5,565,231. Woolen goods, slaughtering and meat-packing, and lumber and other mill products from logs or bolts, were important industries, as was also leather, tanned and carried, which gave a product valued at \$3,447,570.

The annual production of coal has not varied much, for several years, from 3,000,000 tons, yielding a return of about the same number of dollars. Nearly 10,000 persons are engaged in mining, and the coke industry employs about 2,500.

The raising of fine cattle and horses has been a prominent industry in Kentucky for many years, and in rearing the latter animals the state stands almost alone in the production of thoroughbreds.

The reports of the state officers for 1895 showed a deficit in the treasury of about \$80,000, almost one half of which belonged to the school fund. During the preceding year the deficit had been almost \$200,000 greater than it had been in 1895, and the payment of state expenses was suspended for a time and the treasury closed. The assessed

valuation of all property in the state was nearly \$600,000,000, on which a tax was levied of 47 cents on the \$100. The hard times of 1893, 1894 and 1895, had operated to cause the non-payment of taxes to such an extent as to bring about the financial troubles mentioned.

The returns of the eleventh census show that Kentucky had a good relative standing in the production of the cereals, as is shown by the following table, the percentage given being that of the entire crop of the United States.

PRODUCT.	ACRES.	PER CENT.	RANK.	BUSHEL.	PER CENT.	RANK.
All cereals -----	4,556,098	3.25	9th	98,511,733	2.80	11th
Corn -----	2,960,382	4.11	9th	78,434,847	3.70	8th
Wheat -----	898,694	2.68	12th	10,797,462	2.29	13th
Oats -----	645,316	2.28	13th	8,775,814	1.08	14th
Barley -----	5,776	0.18	24th	165,959	0.21	22d
Rye -----	45,546	2.10	15th	423,847	1.49	13th

The showing above made was not equaled in any item by any state within the south-central group, to which Kentucky belongs, with the single exception of Texas, which stood one number higher in the table showing the order of production in the item of area devoted to corn, and one above in the production of oats.

The National Guard of Kentucky, locally known as the Kentucky State Guards, numbered, in 1895, 1,471 officers and men. The force was organized into three regiments of infantry, no other arm of the service being represented. The annual state appropriation is \$10,000, which is supplemented by a Federal appropriation ranging from \$8,000 to \$12,000, mainly in arms and equipments. State encampments occupying ten days are held annually. The number of persons in the state liable to military duty was given at the beginning of 1896 as 361,137, and the authorized strength of the guard at 3,500.

The Central Asylum for the Insane at Lakeland reported 1,083 inmates in October, 1895. The expenditures for the year were \$169,000. Other institutions for the insane are located at Anchorage, Lexington and Hopkinsville. The Institution for Deaf Mutes at Danville reported 295 pupils in October, 1895, the cost of whose maintenance for the preceding year was \$55,000 for the whites and \$7,591 for the negro department, in which were 40 pupils. The Institution for the Blind at Louisville had, for the year 1895, 104 white and 26 negro pupils. The expenses were \$26,576.

The Institution for Feeble-Minded Children was destroyed in the summer of 1896, in which nearly 100 children at the time were confined. No loss of life resulted, but the building was totally destroyed, and the children, from their condition, were rescued with much difficulty.

The schools of the state number nearly 7,000; the children of school age, 700,000, of whom 115,000 are negroes. The state board of education holds irredeemable state bonds of the value of \$2,312,596, the annual interest on which is paid by the state, and goes to the support of the public schools. The annual expenditures for the maintenance of the

schools of Kentucky are nearly \$2,000,000. Institutions of higher education are many, the colleges numbering 33, the academies about 60, and many schools for instruction in particular branches of learning. Of the colleges, the leading institution is Center College (q.v., in these Supplements), located at Danville. Of the denominational institutions of learning in Kentucky, Columbia Christian College at Columbia, Eminence College at Eminence, South Kentucky College at Hopkinsville, and Kentucky University at Lexington, are all

under the control of the Christian Church. Georgetown College at Georgetown, Liberty College at Glasgow, and Bethel College at Russellville, are controlled by the Baptist Church. The Presbyterian Church controls the Central University at Richmond and Center College at Danville. The Roman Catholic Church has St. Mary's College at St. Mary's, the Methodist Episcopal Church has Union College at Bourbonville, and the Methodist Episcopal South Church has Kentucky Wesleyan College at Winchester. Three non-sectarian institutions are maintained, one at Berea, known as Berea College; one at Bowling Green, known as Ogden College; and Garrard College at Lancaster.

The following table shows the colleges for women in Kentucky, with their location, and the auspices under which they are conducted:

LOCATION.	INSTITUTION.	HOW CONDUCTED.
Bowling Green.	Potter College.	Non-sectarian.
Clinton.	Clinton College.	Baptist.
Danville.	Caldwell College.	Presbyterian.
Glendale.	Lynnland Female College.	Baptist.
Harrodsburg.	Young Ladies' College.	Non-sectarian.
Hopkinsville.	Bethel Female College.	Baptist.
Lexington.	Hamilton Female College.	Christian.
Millersburg.	Millersburg Female College.	Methodist Episcopal South.
Nicholasville.	Jessamine Female Institute.	Non-sectarian.
Owensboro.	Owensboro Female College.	Non-sectarian.
Pewee Valley.	Kentucky College for Young Ladies.	
Russellville.	Logan Female College.	Methodist Episcopal South.
Stanford.	Stanford Female College.	Non-sectarian.
Winchester.	Winchester Female College.	Christian.

The church organizations of Kentucky number about 5,500, with 4,700 edifices. All Baptist bodies number about 2,000, the Methodist Episcopal South coming next, with almost 1,000 organizations. Other

denominations of importance are the Disciples of Christ, Negro Baptists, Methodist Episcopal and Cumberland Presbyterians.

STATE ELECTION FOR GOVERNOR (1899). Very keen and bitter was the contest in 1899 for the governorship of Kentucky, the struggle in the Democratic party being the more violent on account of personal hostility to the aspiring candidate, Senator William Goebel, who was long a conspicuous figure in Kentucky politics, and whose career, later on, was ended by a tragic occurrence. Senator Goebel was the author of the State Election law which was obnoxious to many, as were his political methods. In spite of this, he received the nomination for Governor at the Democratic convention held at Louisville, June 24, 1899. Another wing of the party held a convention some two months later at Lexington, which nominated an independent or anti-Goebel ticket. On July 13, the Republican convention met also at Lexington and nominated for Governor, Mr. W. S. Taylor, the attorney-general of the State. The election came off on Nov. 7, the official returns for the two principal candidates being as follows: W. S. Taylor (Rep.), 193,714; Wm. Goebel (Dem.), 191,331. So strong was the rival party feeling and so bitter the opposition to Goebel in the Democratic ranks that the State militia was in attendance at Louisville on the polling day. Advantage was taken of that fact by the defeated Democrats to protest against the election and bring the matter before the Legislature and the courts. Great political tension existed for many weeks after the election, but on Dec. 9, Mr. Taylor was given a certificate guaranteeing his proper return and he assumed the office of Governor. This, however, only added fuel to the fire already burning and quickened Democratic zeal to inquire into the alleged irregularities of the election. While these inquiries were being made and the State was in a continued turmoil owing to the obstructions placed in the path of the seated Governor, Senator Goebel was shot on Jan. 30, 1900, while walking in the capitol grounds on his way to the State House, and died Feb. 3. The assassin, James Howard, was later on in the year found guilty, the jury rendering a unanimous verdict that the death penalty should in his case be imposed. As we write, a new trial has been asked for, on the ground that some of the jurymen were prejudiced against the accused. Henry E. Voutsey, as we write, is also on trial for complicity in Senator Goebel's murder. Kentucky, meanwhile, has succeeded in securing a new Election law, a manifest improvement on the obnoxious Goebel measure.

KENYON COLLEGE, an educational institution for young men, located at Gambier, Ohio. It was started at Worthington, Ohio, in 1824, as a theological seminary of the Protestant Episcopal Church, but was removed to Gambier in 1828, and a college and seminary organized separately. In 1891 the two were united, and a preparatory department was added, all under the name of Kenyon College. The institution has productive property worth \$500,000 and an in-

come, from all sources, of \$18,000, besides being well equipped with buildings and apparatus, and having a library of 30,000 volumes. The student body averages about 180, and there are

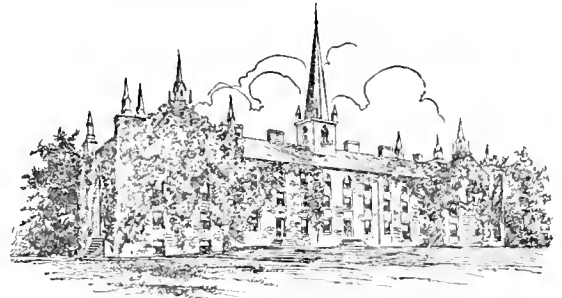

"OLD KENYON."—THE COLLEGE DORMITORY.

18 instructors and professors in the faculty. There are also about twelve scholarships.

KEOKUK, a thriving city of Iowa, one of the capitals of Lee County, in a thriving fruit-raising region. The river is crossed at this point by a fine railroad bridge, which connects Keokuk with the towns of Warsaw and Hamilton, Illinois. Keokuk has a Roman Catholic academy, a Lutheran school, and business and medical colleges. The Mississippi is navigable at this point for large steamboats, and the United States government has constructed, at the cost of \$8,000,000, a ship-canal, ten miles long and three hundred feet wide, around the Des Moines Rapids, which extend from Keokuk northward. The city is built on limestone bluffs 150 feet high, and the limestone affords excellent material for building purposes. The manufactures are various, and the business of the town is prospering. It is supplied with electric lights, gas and water, and has a sewer system. Population 1890, 14,101; 1900, 14,641. See also KEOKUK, Vol. XIV, p. 45.

KEOKUK, a chief of the Sacs and Foxes; born on Black River, Illinois, about 1780. He was of the tribe of Sacs, and rose to distinction during the War of 1812. Opposed to the sway of Black Hawk and other chieftains, he sided with the whites, and on several occasions succeeded in quieting his turbulent followers. After the capture of Black Hawk in 1832, Keokuk was recognized formally as the head chief of the Sacs and Foxes. In 1837 he visited Washington, when peace was made between his people and their old-time adversaries, the Sioux. Afterward, his party, in company with Black Hawk, visited the principal cities of the Union. In 1832 the United States government gave the Indians a reservation on Iowa River, and in 1845 they were removed to Kansas. In 1848 he was poisoned by an Indian of the Black Hawk band. He was not a hereditary chief, but attained his eminence by the force of his own powers.

KEOSAUQUA, a village and the capital of Van Buren County, southeastern Iowa, on a loop in the Des Moines River, 40 miles above its mouth, and on the Chicago, Rock Island and Pacific railroad. Grain and live-stock, building-stone and hardwood lumber are the products of

Keosauqua and its vicinity. Population 1890, 831; 1900, 1,117.

**KÉPHIR**, a fermented milk. What *koumiss* is to the inhabitants of southwestern Russia, *kephir* is to those of the northern Caucasus. In its preparation, cow's, sheep's or goat's milk is fermented in leathern bottles with *kephir-grains*. These grains are masses of fungi and bacteria. At a given stage the *kephir-grains* are removed and dried in the sun, when they are ready for another service. On analysis it is concluded that the fermentation of the milk is entirely due to *Saccharomyces Mycoderma*.

**KÉRATRY**, ÉMILE, COMTE DE, a French soldier and politician; born in Paris, March 20, 1832, of an ancient Breton family, his father being Count Auguste Hilarion Kératry, who died in 1859. Having completed his studies at the lycéums of St. Louis and of Louis-le-Grand, he enlisted as a volunteer, went through the Crimean campaign, and in 1861 engaged in guerrilla warfare in Mexico. In this service he distinguished himself by his bravery and decision, and afterward was appointed officer of ordnance to Marshal Bazaine. The Comte de Kératry was mentioned several times in the "Order of the Day" in Africa and Mexico, but in 1865 retired from the service. At this period he had received the Legion of Honor, and had been decorated with several foreign orders. On his return to France he devoted himself to literary pursuits, and contributed to the *Revue Contemporaine* a remarkable series of articles on the Mexican expedition, in which he severely attacked the government and the conduct of Marshal Bazaine. Soon afterward he became editor of the *Revue Moderne*, in which periodical he continued his accusation. In 1869 he was returned by the electors of Brest to the Corps Législatif, when he associated himself with the new Liberal Tiers Parti. On the establishment of the Government of the National Defense in September, 1870, he was made prefect of police, but in the following month he escaped in a balloon from Paris, then besieged, and proceeded on a diplomatic mission to Madrid, where, soon afterward, he was succeeded by M. Edmond Adam. He was the author of *Le Contre-Guérilla* (1867); *La Créance Jecker* (1867); *L'Élévation et la Chute de Maximilien* (1867); a work on French events, entitled *Le 4 Septembre et le Gouvernement de la Défense Nationale* (1871); *Armée de Bretagne 1870-71* (1874); *Mourad V, Prince, Sultan, Prisonnier d'État* (1878); and *À Travers le Passé, Souvenirs Militaires* (1887).

**KÉRITE** OR ARTIFICIAL CAOUTCHOUC, a compound invented by A. C. Day. It is used principally for insulating, and is made by vulcanizing, by means of sulphur, a combination of animal or vegetable oil with India rubber.

**KERMADEC**, a cluster of four small volcanic islands in the Pacific, 450 miles N.E. of New Zealand, between 29° 10' and 39° 30' S. lat. and 177° 45' and 179° W. lat. The largest is Sunday Island, 20 miles in circumference; it is very rugged and heavily timbered. The soil is very

rich, and fish are plentiful about the coast of all the islands. Area, 15 square miles. Population 1893, 7.

**KERMESITE**. See MINERALOGY, Vol. XVI, p. 396.

**KERMESSE** OR KIRMESSE, a festival of Holland and Belgium, formerly religious, but now secular. All sorts of amusements and outdoor sports are indulged in, and usually it is held out of doors. In order to prevent the degeneracy of the custom and an overcrowding of the ground, Joseph II of Flanders ordered all the festivals to be held on the same day, but the rule disappeared with the Austrain domination.

**KERN**, a river of Kern County, southern California, rising on Mount Whitney, and flowing south, east and north into Lake Tulare. Length, 210 miles. Its course is through magnificent scenery, especially in its upper part.

**KERN**, JACQUES CONRAD, a Swiss statesman; born in 1808, near Arenenberg, in the canton of Thurgau, Switzerland. After studying at the gymnasium of Zurich, he proceeded to the university of Basel, to study theology, which he gave up; became a law student, and finished his education in the schools of Berlin, Heidelberg and Paris. From 1837 he performed in his canton the duties of president of the supreme court of judicature, and those of president of the council of education. He was, from 1833, under the old compact as under the new federal constitution, regularly chosen representative of his canton in the Diet or in the National Assembly. In 1838, when France demanded the extradition of Louis Napoleon, he was largely influential, in the Diet, in stirring up the Swiss to refuse the demand. He was active in the preparation of the federal constitution (1848); founded the Polytechnic School of Zurich, and at the conference of the great powers in Paris represented Switzerland. He died in Zurich, April 15, 1888.

**KEROWLY**. See KARAUJI, Vol. XIV, p. 4.

**KERRVILLE**, a town and the capital of Kerr County, southern central Texas, on the Guadalupe River, the terminus of a branch of the San Antonio and Aransas Pass railroad, 89 miles W. of Austin. It is in a cotton, lumber, and stock-raising region, and has a wind-mill factory and flour-mills. Population 1900, 1,423.

**KERSEYMERÉ**, a corruption of the word *cashmere* (cashmere), sometimes abbreviated to kersey, a fine woolen fabric made in England and the United States, intended for men's clothes. In the latter country the cloth is known as cassimere. Another form of kersey is a coarse twilled fabric made from long wool in the north of England.

**KERSHAW**, JOSEPH BREVARD, an American soldier; born at Camden, South Carolina, Jan. 5, 1822. He was admitted to the bar in 1843; served in the state senate from 1852 to 1857, and was a member of the secession convention in 1860. When the Civil War broke out he raised a regiment and joined the Confederate army; became a major-general before the close of the war,

and was then imprisoned for several months at Fort Warren. He was engaged in the battles of Bull Run, Antietam, Fredericksburg, Chancellorsville and Chickamauga, and it was his brigade that led Longstreet's charge at Gettysburg, in which he lost half his men. He was president of the state senate (1865-66), judge of the circuit court of the state (1877-93); and at the time of his death was postmaster at Camden. He died at Camden, April 13, 1894.

KERVILER, RENÉ POCARD, a French civil engineer; born at Vannes, France, Nov. 13, 1842; received his education at the Ecole Polytechnique and at the Ecole des Ponts et Chaussées. He was sent with various commissions to England, Holland and Belgium, and then, in succession, to Tarbes, St. Briec and Nantes. In 1874 he was sent to St. Nazaire to construct the Penhouët basin; was made engineer-in-chief and decorated with the cross of the Legion of Honor. Among his writings are a series of papers on the French Academy, its history, leaders and patrons; *Recherches et Notices sur les Députés de la Bretagne aux États Généraux* (1888); *La Pucelle* (1882); and *Répertoire Général de Bibliographie Bretonne*.

KERVYN DE LETTENHOVE, JOSEPH MARIE BRUNO CONSTANTIN, BARON, a Belgian historian; born at St. Michel, near Bruges, Aug. 17, 1817. From an early age he devoted himself to historical studies. He was for many years a member of the Chamber of Representatives. When the Conservatives came into power in July, 1870, he accepted office under Baron d'Anéthan as Minister of the Interior, and retained that post until the resignation of the ministry in December, 1871. He was author of *Histoire de Flandre* (1850); *Étude sur les Chroniques de Froissart*, which was "crowned" by the French Academy in 1856; *Les Huguenots et les Gueux* (1883, 1886); *Marie Stuart, l'Œuvre Puritaine, le Procès, le Supplice* (1889); *Histoire et Chroniques de Flandre* (1879); *Jacques d'Arvelde* (1863); *Le Prince d'Orange* (1867); and *Les Chroniques des Comtes de Flandre* (1849). He likewise edited the works of Chartellain (6 vols.) and *Lettres et Négociations de Philippe de Comines*. He died April 3, 1891.

KETTELER, WILLIAM EMANUEL VON, a German ecclesiast and polemic writer; born at Münster, Westphalia, Dec. 25, 1811. He studied law and entered the civil service of his native city; but, under the influence of the Galitzic circle, he began studying theology and became a priest (1844). In 1850 he became bishop of Mayence. His aim in life was to restore the Catholic Church to the place which it held during the middle ages, and therefore opposed with all his might the establishment of a German empire under the Protestant house of Hohenzollern. He also opposed Bismarck unceasingly, as he believed his policy to be antagonistic to the Roman Catholic Church. Among his writings is *Die Arbeiterfrage und das Christenthum* (1864), besides a large number of pamphlets of a polemic character. He died at Burghausen, Bavaria, July 13, 1877.

KEUKA COLLEGE, a co-educational institution, situated at Keuka, Yates County, New York. It was organized in 1892, under the control of the Free Baptist Church. The nearness of Lake Keuka adds to its natural advantages. With a student body of 150 there is a faculty numbering 12. The income-bearing property amounts to \$75,000, and there is a library of over 2,000 volumes.

KEUKA LAKE, a Y-shaped body of water, mostly in Yates County, western central New York, in a beautiful undulating vine-clad region. It extends from Hammondsport to Penn Yan, about 20 miles long. Its width is about two miles, and it is 200 feet deep. It has a line of steamers on it, and is connected by canal with Seneca Lake, its outlet being at Penn Yan.

KEUPER GROUP. See GEOLOGY, Vol. X, pp. 352, 353.

KEWANEE, a post village of Henry County, northwestern Illinois, on the Chicago, Burlington and Quincy railroad, 132 miles W. of Chicago. It has foundries and machine-shops, several wagon and carriage shops, and manufactories of agricultural implements, soil-pipe, pumps, and of steam-heating apparatus. In the vicinity are inexhaustible beds of bituminous coal. It has good public schools, and a public library containing 6,000 volumes. Population 1890, 4,569; 1900, 8,382.

KEWAUNEE, a village and the capital of Keweenaw County, eastern Wisconsin, on Lake Michigan, at the outlet of Keweenaw River, on the Green Bay, Winona and St. Paul railroad, 26 miles E. of Green Bay. It contains a saw-mill, foundry, flour-mills, a pearl-button factory, machine-shop, furniture factory, and has a large trade in wheat and lumber. Population 1895, 1,529.

KEWEENAW SERIES, in the geology of North America, a group of rocks, forming a subclassification of the Algonkian or Huronian formation. In its restricted and more intelligible sense it relates only to the alternating sandstone, amygdaloid and conglomerate formation of the western south shore of Lake Superior, but has been extended by some geologists so as to form a corporate part of the Huronian, in a hollow basin of which series lies Lake Superior. The Keweenaw Series proper extends along upper Michigan and Wisconsin, and touches the eastern edge of Minnesota, but does not reach the northern shore of the lake. This sandstone and conglomerate formation contains the famous copper-mines of northern Michigan and numerous quarries of Old Red or Potsdam Sandstone, and, with the superincumbent gravel-deposits, reaches, in places, a thickness of thousands of feet.

KEW GARDENS, London, were first formed as a botanic garden by the Princess Augusta of Saxe-Gotha, dowager Princess of Wales, in 1760. A treasury committee to consider the management was appointed in 1838, and the gardens were transferred to the Commissioners of Woods and Forests in 1840. The Botanic Garden was opened to the public, free, in 1841; the Arboretum, in 1847. The Palmhouse was built

in 1848; the Temperate-house in 1862. There are 248 acres on the grounds, 70 acres of which are in the Botanic Gardens proper, the rest being in the Arboretum. They form the most important botanical establishment in the world.

**KEW MAGNETOMETER.** See METEOROLOGY, Vol. XVI, p. 161; and MAGNETISM, Vol. XV, pp. 239, 240.

**KEW OBSERVATORY,** Old Deer Park, Richmond, Surrey, England, was built by George III, in preparation for the famous transit of Venus in 1769. The building eventually was handed over to the British Association for the Advancement of Science in 1842, under the title of the Kew Observatory. The connection between the British Association and the Kew Observatory lasted for thirty years, until 1871. Mr. J. P. Gassiot, who was then the chairman of the Kew Committee, made the offer to endow it with a sum of £10,000 if the Royal Society would nominate a Kew committee, who should have entire control over the management of the observatory and over the income from the trust fund, and cause magnetic and meteorological observations to be continued in perpetuity, which offer was accepted. It is subsidized as the central station of the Meteorological Office for the system of self-recording observations, as a place where new instruments intended for other observatories can be tested beforehand, as a school where intending observers can be trained practically, and lastly, as an experimental laboratory, where the efficiency of new designs of meteorological instruments may be tried thoroughly. A largely increased and increasing number of instruments are continuously in progress of verification, suitable fees being charged to the public and the various government offices to defray the cost of the examination. During 1892 an elaborate piece of apparatus, designed by Major Darwin, for the purpose of examining photographic lenses for the public, was added to the verification appliances. See also OBSERVATORY, Vol. XVII, p. 710.

**KEY.** One of the various systems of tones in music, in each of which the numbers have the same relations among themselves, although they are of other absolute pitch than the corresponding numbers of the remaining keys. They are considered with special reference to the relation of the other tones to the tonic or key note. See also MUSIC, Vol. XVII, pp. 88, 89, 105.

**KEY, SIR ASTLEY COOPER,** an English admiral; born in 1821; was educated at the Portsmouth Naval College; entered the navy as lieutenant in 1835; was in constant service, and for gallantry was made commander in 1845 and captain in 1850. He served throughout the Baltic campaign of 1855, in 1857 during the Indian mutiny, and in China in 1858. He was placed in charge of the Naval Ordnance Bureau, and superintended the first attempts in armor-plate manufacture. He was superintendent of the Portsmouth navy-yard, and principal of the Greenwich Naval College in 1873-76. He became an admiral in 1878, and

was first naval lord of the admiralty. He died March 3, 1888, in Maidenhead.

**KEY, ERNST AXEL HENRIK,** a Swedish pathologist; born in Småland, Sweden, in 1832; was educated as a physician at the University of Lund; later studied at the Seraplinn Hospital, Stockholm, and then with Max Schultze at Bonn, and with Virchow in Berlin. In 1862 he became professor of pathology in Caroline Institute, Stockholm; associate editor of *Medicinskt Arkiv* (1863-68); and editor of *Nordiskt Medicinskt Arkiv* from 1869; and represented his city in the lower house of Parliament in 1882. He contributed to scientific literature, *Studien in der Anatomie des Nervensystems und des Bindegewebes*, for which he was awarded the Montyon gold medal by the French Academy in 1876.

**KEY, FRANCIS SCOTT,** an American poet; born in Frederick County, Maryland, Aug. 9, 1780. He studied law in the office of his uncle, and practiced law at Frederick City, Maryland, until he became district attorney in Washington, District of Columbia. When the British invaded Washington in 1814, they seized Dr. William Beanes, a planter, as a prisoner, and Key, aided by President Madison, resolved to release him. He went with John S. Skinner, agent for the exchange of prisoners, in a cartelship, to the British general, Ross, who finally consented to Dr. Beanes's release, but detained the party during the attack on Baltimore. From their ship they could see the flag on Fort McHenry nearly all night by the glare of the battle; but before morning the firing ceased, and they watched most anxiously to ascertain which colors floated on the ramparts in the morning. Key's feelings, when he saw that the stars and stripes had not been hauled down, found expression in the *Star-Spangled Banner*, which gained for him a lasting reputation. It was to be sung to the tune, "Anacreon in Heaven." The verses and tune soon became popular throughout the United States. A collection of Key's poems was published in 1857. James Lick, of California, bequeathed the sum of \$60,000 for a monument to Key. It was erected in Golden Gate Park, San Francisco, in 1887. He died in Baltimore, Maryland, Jan. 11, 1843.

**KEYES, ERASMUS DARWIN,** an American soldier; born at Brimfield, Massachusetts, May 29, 1810. He was graduated from the United States Military Academy in 1832; served in Charleston harbor during the nullification troubles in 1833; and in 1837-41 was aide to General Winfield Scott. After being made captain he served as instructor of artillery and cavalry at West Point from 1844 to 1848, and afterward served in the field on the northwestern frontier. During the Civil War he fought as brigade-commander in the first battle of Bull Run; commanded the Fourth Corps of the Army of the Potomac under General McClellan; and was engaged actively in the Peninsular campaign, which gained for him the promotion to major-general of volunteers. In 1863 he took part in General Dix's expedition against Richmond. He resigned in 1864. He

then removed to California, where he became president of the Mexican Gold-Mining Company (1867-69) and vice-president of the California Vine Culture Society (1868-72). In 1884 General Keyes published *Fifty Years' Observation of Men and Events*. He died at Nice, France, Oct. 14, 1895, and was buried the following January, with full military honors, at West Point.

KEYPORT, a post town of Monmouth County, central eastern New Jersey, on Raritan Bay, and on the Central Railroad of New Jersey, 25 miles S.S.W. of New York City. Here are flour-mills, a fruit-canning factory, wagon and carriage and sash and blind factories, a clam bouillon factory and a large brick-yard, and an important enterprise of the town is growing oysters, which were introduced from Virginia. It is very popular as a summer resort. Population 1900, 3,413.

KEYSER, a town and the capital of Mineral County, eastern West Virginia, on the Baltimore and Ohio and the West Virginia Central and Pittsburg railroads, 20 miles S.W. of Cumberland, Maryland, and on the North Fork of the Potomac. It has some railroad machine-shops, a roundhouse and manufactories of wagons and lumber, and has considerable trade in grain, wool and cattle. Population 1890, 2,165.

KEYSER, PETER DIRCK, an American surgeon; born in Philadelphia, Feb. 8, 1835; made a study of chemistry in Philadelphia, and went to Europe in 1854, but returned to enter the army in the Civil War. He was forced to resign on account of ill-health during the war, so he went back to Germany, where he was graduated from the University of Jena in 1864. Returning, he entered the army as acting assistant surgeon. In 1865 he resigned and took up private practice in Philadelphia. He was successively surgeon in charge of the Philadelphia Eye and Ear Infirmary (1868); ophthalmic surgeon to the medical department of the German Society of Philadelphia (1870); and a surgeon to the Wills Eye Hospital in Philadelphia (1872); was a member of the Pennsylvania Medical Society, and contributed to various magazines in the United States and Europe on strictly scientific subjects. Among his works are *On the Use of Chloral Hydrate after Operations on the Eye* (1871); *On Congenital Hereditary Dislocation of Both Lenses*; and *Phosphatic Degeneration of the Cornea* (1874).

KEY WEST, a city and port of entry in Florida, the southernmost city of the United States. Among the prominent buildings are a city-hall, county court-house, custom-house, government barracks, marine hospital, United States court-house; and Fort Taylor, a casemated pentagonal brick structure, forms the principal fortification of the island. The most important business is the making of cigars. As the climate of Key West is remarkably equable and free from the extremes of cold and heat, Key West has of recent years become a famous winter resort, especially for consumptive patients. "Key West" is a mispronunciation of the Spanish name of the island, *Cayo Hucso*, meaning Bone Key. Population

1800, 18,080; 1900, 17,114. See also KEY WEST, Vol. XIV, pp. 55, 56.

KHABUR, an affluent of the Euphrates. See MESOPOTAMIA, Vol. XVI, p. 48.

KHĀIBAR PASS, a pass over the Sulāiman Mountains, forming part of the great northern military route between India and Afghanistan. It begins a little west of Peshāwa, in lat. 34° N., where the Punjab state railway stops, and runs up to the northwest, through the mountains at their juncture with the Safid Koh Range, and ends at Dhaka fort, opposite Lalpura, in the valley of the Kabul. The pass is about 33 miles long, and varies in width from 10 feet, in a very few places, to 450. The summit is 1,970 feet above Dhaka.

KHALID, BEN AL-WALID, a Moslem general; born in Mecca, in 582. He was in command of the Koreish cavalry at the battle of Ohod, when Mohammed was defeated; but being converted to the faith in 629, he served under the Caliphs from that time. He led the Moslem forces in northwestern Arabia, and won the battle of Yermouk, which caused Heraclius to abandon Syria in 636, and captured Mecca in 635. He was disliked by the Caliph Omar, and passed his last years in disgrace at Enusa, where he died in 642. See also ARABIA, Vol. II, p. 257.

KHALKAS. See MONGOLS, Vol. XVI, p. 744.

KHALLIKAN. See IBN-KHALLIKAN, Vol. XII, p. 609.

KHARAY. See KARAK, in these Supplements.

KHAYAM. See OMAR KHAYAM, Vol. XVII, p. 771.

KHEDIVE, title of the Viceroy of Egypt. It was granted in 1866 to Ismail Pasha by the Turkish government, and Aug. 14, 1867, it was made hereditary, in consideration of which the annual tribute of Egypt was raised from £376,000 to £720,000. Since Great Britain came into control in 1882, the title of Khedive has been of only nominal importance.

KHORSABAD, an ancient village of Asiatic Turkey. Among the ruins here, discovered in 1843, were found the first historical cuneiform inscriptions of ancient Assyria. See also ARCHITECTURE, Vol. II, p. 399; and MADRAS, Vol. XV, p. 185.

KIAU-CHAU, a port, town, and district on the east coast of the Chinese province of Shan-tung, which were seized by Germany in Nov. 1897, and in the following March were by treaty transferred to Germany on a 99 years' lease. In April, 1898, the district was declared a protectorate of the German empire, and its administration entrusted to the navy department, a naval officer being placed at its head with the title of governor. The area of the protectorate is about 200 square miles, exclusive of the bay on which the port is situated, and it has a population of about 60,000. The garrison consists of marines and marine artillery, about 1,500 in all. Extensive coal mines, about 100 miles inland, at Wiehsin and Pashan, are about to be worked with German capital, by agreement with China, and concessions have also been granted for the construction of railways in the district.



KIANG-SI OR KEANG-SE, a province of CHINA (q.v.), Vol. V, pp. 635, 636.

KIANG-SU OR KEANG-SOO, a province of CHINA (q.v.), Vol. V, p. 635.

KICKAPOO INDIANS, a tribe of the Algonquin family of North American Indians, which were first found by French and English pioneers inhabiting the Ohio Valley and northward into Wisconsin and Michigan. They were first met by the Jesuit explorers on the Wisconsin River, but later, in 1763, were found in Indiana by the English. They were engaged in constant warfare with the Americans, and took part in the War of 1812. Treaties were signed at the close of that, and the Kickapoos moved westward and southward. At one time the majority of the tribe engaged in a marauding expedition into Texas and Mexico, but were brought back by the United States government and settled in Kansas and Indian Territory. In 1895 the Kickapoos in the United States numbered 502, of whom 231 were on a reservation in Nemaha County, Kansas, and 271 in eastern Oklahoma.

KICKING-HORSE PASS, a pass in the Rocky Mountains in lat.  $51^{\circ} 26' N.$ , through which the Canadian Pacific railroad runs. The scenery is very beautiful. Altitude, 5,296 feet.

KIDD, BENJAMIN, an English sociological writer; born in London in 1859; employed in the British civil service, having been for some years in charge of a statistical department at Somerset House. Practically nothing is known to the world concerning Mr. Kidd's life, although he is said to have contributed articles to the *Nineteenth Century*, *Cornhill* and other English reviews prior to the appearance of his book *Social Evolution* (1894).

This work created a sensation, not only among lay readers, but among theologians and scientists. It deals with social phenomena, and bears especially upon the problem of the intellectual and moral development of mankind, and the relation of biological science thereto. Admitting the truth of the doctrine of natural selection, it not merely makes the recent theories of Professor August Weismann the sole exponent of that doctrine, but it expands Weismannism to the degree of converting it into an active champion of the cause of supernatural religion.

In adopting Weismann's main contention, that acquired characters are non-transmissible in heredity and that variations are produced entirely through primordial determinant germ-cells, the book takes violent issue with the Darwinian view—now held by Mr. Herbert Spencer and others—that variations are produced by the transmission of acquired faculties arising through contact of the individual with the conditions of the external world. Mr. Kidd assumes that the older Darwinian view excludes the possibility of teleological explanations, and that Weismann's theory admits of them. Mr. Kidd is gifted with a vigorous and attractive style; and in assuming, as his predominant theme, that religion is the prime factor in human development, his methods

seemed so comprehensible to the uncritical reader, and he struck so responsive chords among many people of divergent classes, that his book had a warm reception. Reviewers and scientific critics attacked his theories as unsound and his deductions as absurd. They declared the work to be not only a pretentious piece of reasoning, but, in its entirety, positively incoherent. But the work supplied so great a want among those who felt alarm over the spreading materialistic implications of the teachings of modern biological science, that for every word of adverse criticism a host of writers arose in its defense. Unprejudiced and competent thinkers regard the work as unscientific and of no permanent value except, possibly, in stimulating the desire for deeper research. In 1898 Mr. Kidd published *The Control of the Tropics*.

KIDD, WILLIAM, a Scotch pirate, commonly known as CAPTAIN KIDD; born, probably, at Greenock, and is supposed to have been the son of a Covenanting minister, who died in 1679. The lad went early to sea, saw much hard service privateering against the French, and gained a high reputation for stubborn courage, and in 1691 a reward of £150 from the council of New York City. A ship of thirty guns was fitted out by a private company in London for suppression of piracy in the Indian Ocean and given to Kidd, who was furnished with the usual letters of marque. In January, 1697, he reached Madagascar, the chief rendezvous of the pirates, but ere long disquieting reports reached England that Captain Kidd was playing the game of pirate himself. After a two-years' cruise he returned to the West Indies, and a few months later had the temerity to go to Boston without securing himself by a safe-conduct. In spite of the half promises that had been made him, he was arrested and sent to England, where he was tried for piracy and the murder of one of his men. Of the latter charge he was formally found guilty and hanged at Execution Dock, London, May 24, 1701, protesting his innocence to the last. The trial was unfair, and it is at least doubtful if he was guilty of the crimes ascribed to him.

KIDNEY. See NUTRITION, Vol. XVII, p. 683.

KIDNEY, DISEASES OF. See PATHOLOGY, Vol. XVIII, pp. 387-389.

KIDNEY, OPERATIONS ON. See SURGERY, AMERICAN, in these Supplements.

KIDO, TAKAYOSHI, a Japanese statesman; born in the province of Choshu, Japan, about 1833; was one of the revolutionary party in his province in 1868, was instrumental in organizing the imperial army; and was a member of the Privy Council after peace had been restored. In 1872 he visited Europe and America as a member of the imperial embassy, but returned to become Minister of State; held an important office in the imperial household; and again became a member of the Cabinet, in 1875. He died June, 1881.

KIDRON OR CEDRON. See JERUSALEM, Vol. XIII, p. 636.

KIEKIE (*Freycinetia Banksii*), a climbing shrub of the family *Pandanaceae*, or screw-pines. It yields an edible fruit said to be the finest indigenous

to New Zealand. It is found in the northern part of that country.

KIELLAND, ALEXANDER LANGE, a Norwegian novelist; born in Stavanger, Norway, Feb. 18, 1849. He was educated at the University of Christiania, and was admitted to the bar in 1872, though he never entered upon the practice of his profession. Instead, he purchased some brick-works near Stavanger, and managed the business connected with their running until 1881. He made several extended trips through Europe; in 1889 became editor of the daily paper, Stavanger *Avis*; and in 1891 burgo-master of Stavanger. He published *Novelletter* (1879); *Nye Novelletter* (1880); *Garman og Worse* (1880); *Else* (1881); *Skipper Worse* (1882); *Sue* (1886); *Jakob* (1891). A great many of his novels are connected by the introduction of characters appearing in them all. He also wrote a number of shorter dramas and farces, but none of them have been particularly successful.

KIEPERT, HEINRICH, a German geographer; born in Berlin, July 31, 1818. After studying geography as a specialty he explored Asia Minor in 1841-42, and became director of the geographical institute at Weimar, in 1845. After 1852 he delivered numerous lectures in Berlin; in 1859 was made professor in the university of that city; and in 1865 was appointed to a position in the statistical bureau there. His most important publications are *Atlas von Hellas*; *Historisch-geographischer Atlas der Alten Welt*, which passed through numerous editions; and *Neuer Hand-Atlas der Erde*. He also wrote *Lehrbuch der Alten Geographie* (1878); and *Travels in Asia Minor*.

KIESELGUHR. See DYNAMITE, Vol. VII, p. 583; and INFUSORIAL EARTH, in these Supplements.

KILAUEA, one of the largest volcanoes in the world. See HAWAIIAN ISLANDS, Vol. XI, p. 531.

KILBOURN OR KILBOURN CITY, a post village of Columbia County, Wisconsin, on Wisconsin River, 108 miles N.W. of Milwaukee. It is at the foot of the noted "Dalles of the Wisconsin," and is a pleasant summer resort. It is the center of the hop-trade of the Northwest, and it manufactures doors, sash and blinds, flour and other articles. Population, 1900, 1,134.

KILLEN, WILLIAM DOOL, an Irish educator and writer; born in Ireland, April 5, 1806. He engaged in the ministry from 1829 to 1842, when he became professor of church history and pastoral theology in Belfast Presbyterian College; in 1869 became president of the same institution; and in 1881 principal of the theological faculty of Ireland. He published *Plea of Presbytery* (1840); *The Old Catholic Church Traced to 755* (1871); *The Ecclesiastical History of Ireland from the Earliest Period to the Present Times* (1875); and *The Framework of the Church* (1890); was also one of the authors of *Presbyterianism Defended* (1839).

KILLER, the popular name of the genus *Orca*, in the family of dolphins (*Delphinida*). They are very ferocious, and often attack and kill the whalebone whales. There are many species, but *O. gladiator* is the best known.

KILLIECRANKIE, a pass in northern Perth-

shire, on the River Garry, in a beautiful wooded region, 15 miles N.N.W. of Dunkeld. Here, on the 27th of July, 1689, Graham of Claverhouse, Viscount Dundee, was killed, while his troops totally defeated those of General Mackay, commander of the forces of William III. The Highlanders were discouraged, however, by the loss of their leader, and the insurrection was speedily put down.

KILLINGTON, a mountain-peak in Sherburne Township, Rutland County, Vermont, 7½ miles E. of Rutland. Its elevation is 4,380 feet, making it the third highest mountain in the State, and the view from its top is picturesque to a degree seldom seen outside of Switzerland.

KILMAINHAM TREATY. See HOME RULE, in these Supplements.

KILWA OR QUILOA, a seaport of German East Africa, acquired by Germany by purchase from the Sultan of Zanzibar in 1890. It is situated in lat. 8° 58' S., 150 miles S. of Zanzibar City. It is a regular coaling-station for the steamers of the German East Africa Company. Population 1893, about 7,000. See also ZANZIBAR, Vol. XXIV, p. 768.

KIMBERLEY, the chief town and capital of Griqualand West, in Cape Colony. It is situated close to the frontier of the late Orange Free State, 647 miles N. E. of Capetown, by rail. The climate is healthy, but hot in summer, and the death-rate is high, on account of the deaths of the diamond-miners, mostly natives. The town is supplied with water-works and electric lights, and has a number of handsome public buildings, including a town-hall, postoffice, high court, public library and botanical library. The great diamond mines here have all been brought under the control of the huge concern known as the De Beers Consolidated Company. In the mines controlled by this organization is found by far the greater part of the diamond output of the world. Their estimated yield per working day before the war was in value about ten thousand pounds sterling, and the owners used to pay out over five million dollars a year in wages.

When the war between Great Britain and the Transvaal broke out (Oct. 10, 1899), Kimberley was at once invested by the Boers. The British and Colonial troops in the town consisted of a detachment of the Loyal North Lancashire battalion, a battery of garrison artillery with some old 7-pounder muzzle-loaders, and a considerable number of volunteers raised and armed by the De Beers Mining Co. The English commander was Colonel (now Major-General) George Kekewich, with whom was shut up in the besieged town the Hon. Mr. Cecil Rhodes, who raised a regiment from his own purse—the Kimberley Light Horse. By the 20th of Oct. (1899), the town was completely invested by the Boers and the long and trying siege began.

The incidents of the siege, which lasted 123 days, were such as Ladysmith and Mafeking had experience of—the lively excitement of bombardment and assault, sortie and sniping, the battling daily against disease, the dodging of flying shell, with ever increasing anxiety over the scarcity of food, yet all borne uncomplainingly and with no thought of surrender. With General Roberts'

advance into the Orange Free State, the prospect finally brightened for the plucky defenders of Kimberley. The hope of relief rose high when it was known that a column of 10,000 men, under General French, was setting out from the Orange River on the 10th of Feb. (1900), to push its way northward, across the Riet and the Modder Rivers, towards the diamond city. A further happy omen was the British entry into and occupation of Jacobsdal, and the anticipated capture of Cronje's army, which followed some twelve days after the relief of Kimberley. Succor came to the latter on Feb. 15, General French entering Kimberley late in the afternoon of that day. European population 1891, 28,718. See also KIMBERLEY, Vol. XIV, p. 77.

KIMBERLEY, JOHN WODEHOUSE, EARL OF, an English statesman; born Jan. 7, 1826. He succeeded his grandfather as Baron Wodehouse (1846); was Under-Secretary for Foreign Affairs (1852-56 and 1859-61); ambassador to Russia (1856); special minister with regard to the Schleswig-Holstein question (1863); Lord-Lieutenant of Ireland (1864-66), during which time he was raised to the earldom of Kimberley; Lord of the Privy Seal (1868); Secretary of State for the Colonies (1870-74), and again in 1880; in 1882-85, Secretary of State for India; held the same position in 1886, and again in 1892, being also Lord-President of the Council; and in 1894 he became Secretary of State for Foreign Affairs, which office he retained till the fall of the Rosebery Cabinet in 1895.

KIN, NEXT OF. See *INTESTACY*, Vol. XIII, pp. 188, 189.

KINCHINJINGA MOUNTAIN. See *HIMALAYA*, Vol. XI, p. 825.

KINDERGARTEN. For the origin and history of the kindergarten system of training children and the manual-teaching system, see *KINDERGARTEN*, Vol. XIV, p. 79. The spread of the system in the United States has been rapid and general. In all of the larger cities and in many of the towns, training-schools have been established for preparing teachers for primary school-work. In some cities the actual methods are carried in the primary grades of the public schools. The introduction of the system is in no small way responsible for the interest in manual training which has resulted in the establishment of numerous industrial institutes. In a commercial way the system has developed establishments for the manufacture of the apparatus used. Prominent among the advocates of the kindergarten system are Dr. Felix Adler, of New York City, and Elizabeth Palmer Peabody, who established the *Kindergarten Messenger*. The National Educational Association has a department devoted to the discussion of kindergarten methods. Especially has the system been successful in teaching the blind. Recognition has been given the kindergarten methods in many of the countries of South America.

KINETICS and KINEMATICS. See *PHYSICAL SCIENCE*, Vol. XIX, p. 2; and *MECHANICS*, Vol. XV, pp. 678-702.

KINETOGRAPH, an instrument for recording the motions of bodies, to be reproduced to the eye

by means of the kinetoscope (q.v.). The kinetograph bears the same relation to the kinetoscope as the recording diaphragm of the phonograph bears to the reproducing diaphragm. The human eye is capable of detecting and separating a maximum of about forty distinct impressions per second of time, and if more than forty are presented before the retina in a second of time, the eye will blend them into one continuous impression or view. The kinetograph is in part a photographic camera so constructed, with attachments and devices invented by Thomas A. Edison, that it records forty-six distinct and separate views of moving objects or scenes during each second of time. In other words, the kinetograph takes forty-six separate and distinct photographs of moving objects every second of exposure. These photographs are recorded on a long film, which is finished substantially as all photographs are finished, and is thus prepared for reproduction and exhibition by means of the kinetoscope. The mechanism has both a scientific and a popular interest.

KINETO-PHONOGRAPH. This name is applied to the combination of Thomas A. Edison's inventions known separately as the phono-kinetograph, phono-kinetoscope, kinetograph and kinetoscope. As arranged for use, a very contracted theater stage is set up, and towards it the kinetographic apparatus is directed to catch the continuous action of the players, while the phonographic portion of the apparatus simultaneously records the sounds they utter, or that come from the musical instruments accompanying. The actors have to be placed under a very strong light, and their utterances must be directed toward the phonograph, to secure good results. The task of causing the phonograph and kinetograph to act in exact unison was one of the most difficult features of the invention, and is accomplished by a most intricate and complicated mechanism. The photographic pictures are produced on a sensitized strip of celluloid, an inch and a half wide, inside of a drum. The celluloid strip is perforated to enable the teeth of a locking-device to hold it steady for nine tenths of the forty-sixth part of a second, which period is allowed for exposure and taking the photograph. Notwithstanding that the film has only the remaining one-tenth of the forty-sixth part of a second in which to make its travel for the next picture, yet the speed of travel maintained by the strip is 26 miles an hour. When the strip is used for exhibition, its great length is coiled away in a most ingenious manner in a case of suitable size. The perfected combination of these devices was completed in 1895, W. K. L. Dickson being associated with Mr. Edison in the work.

KINETOSCOPE, a companion invention to the kinetograph, by Thomas Edison, 1894. The photographic views taken by the kinetograph in rapid succession are exhibited in the same order by the kinetoscope, a mechanical device, operated by electricity, so constructed as to run the views at a speed of about forty-six a second. The views pass over a series of rollers which hold them steady. The kinetoscope is, for purposes of commercial exhibi-

tion, placed in a cabinet, in the top of which is a small window, covered with clear glass. The observer of the views looks down through this window, and the film passes before his eyes with such rapidity that he beholds practically one continuous picture. The apparatus is a cabinet about four feet high by two feet wide and one foot nine inches deep, and it contains a small electric motor. Among the pictures presented by the kinetoscope are the successive steps of a dancer and features of a stage production.

KING, CHARLES, an American soldier and author; born in Albany, New York, Oct. 12, 1844; graduated from West Point (1866); served in garrison duty (1866-69); at the Military Academy (1869-71); frontier duty (1874-79). He was made captain in May of 1879, and retired in June, on account of wounds received in line of duty. He was inspector-general of the Wisconsin National Guard and colonel of the Fourth Regiment (1882-89), and then became commander of cadets at the Michigan Military Academy. He wrote *The Colonel's Daughter* (1882); *Famous and Decisive Battles* (1884); *Marion's Faith* (1885); *Captain Blake* (1891); *Cadet Days* (1894); *Trooper Ross* (1895); *From School to Battlefield* (1898); and many shorter stories.

KING, CLARENCE, an American geologist; born in Newport, Rhode Island, Jan. 6, 1842. He graduated at Sheffield Scientific School (1862), and was connected with the geological survey of California (1863-66). In 1867 he was placed in charge of the United States geological survey of the fortieth parallel. In 1878 he was made the first director of the United States Geological Survey, but resigned in 1881, and afterward engaged in special investigations. *Systematic Geology*, published by the government, was written by him (1878); also *Mountaineering in the Sierras* (1871); and various articles in scientific journals in the United States and Europe. He was elected a member of the National Academy in 1876.

KING, RUFUS, an American statesman; born at Scarborough, Maine, March 24, 1755; graduated at Harvard College in 1777. He studied law and began practice in Newbury, Massachusetts, in 1780; became a member of the legislature in 1782, and was sent by it as a delegate to the Continental Congress at Trenton in 1784, and introduced a measure for the prohibition of slavery in the territories of the Northwest; was a member of the Federal Constitutional Convention; and was afterward instrumental in securing the ratification of the constitution by Massachusetts. He served in the United States Senate (1798-96), where his advocacy of the ratification of the Jay treaty with England won the admiration of Washington, who offered him the Secretaryship of State and appointed him Minister to England. This post he held until 1803, when he settled on a farm in Long Island. But in 1813 he re-entered public life, becoming United States Senator and serving till 1825, when he again became Minister to England. His health failing, he resigned in 1826. He was always opposed to slavery, and fought against it throughout his life; also opposed the second war with England, but gave it his

support after hostilities commenced. He died at Jamaica, Long Island, April 29, 1827.

KING, THOMAS STARR, an American clergyman; born in New York City, Dec. 17, 1824. Having first served as a clerk in a store, in 1840 he was made an assistant teacher in the Bunker Hill grammar-school, and in 1842 became principal of the West grammar-school of Medford, Massachusetts. In 1845 he began to preach, and in 1846 was called to a church in Charlestown. In 1848 he became pastor of the Hollis Street Unitarian Church, Boston, and held this post for 11 years. In 1860 he accepted a call to San Francisco, California, remaining there until his death. It was largely, if not wholly, due to his patriotic efforts that California remained loyal to the Union, and that the United States Sanitary Commission secured the generous sums of money which enabled it to carry on its work during the war. Mr. King was the author of *The White Hills: their Legend, Landscape and Poetry* (1859); *Patriotism and other Papers* (1864); and numerous printed sermons. He died March 4, 1864.

KING, WILLIAM RUFUS, an American statesman; born in Sampson County, North Carolina, April 7, 1786. In 1806 he was admitted to the North Carolina bar, and in the same year became a member of the state legislature. He was re-elected in 1808, and in 1809 was sent to Congress, where he remained until 1816, when he was made secretary of legation at Naples and afterward at St. Petersburg, holding the position till 1818. He then removed to Dallas County, Alabama, and on the adoption of the state constitution became a United States Senator. He served until 1844, when he was appointed minister to France. In this capacity he paved the way for the annexation of Texas without the intervention of foreign powers. In 1848 he again became United States Senator, and in 1852 was chosen Vice-President of the United States on the ticket with Franklin Pierce, taking the oath in Havana, but was never able to enter on the duties of the office. Died in Dallas Co., Ala., April 18, 1853.

KING AT ARMS. See HERALDRY, Vol. XI, 687.

KING-CRAB. See CRUSTACEA, Vol. VI, p. 662.

KING-FISH OR OPAH. See YELLOW-TAIL, Vol. XXIV, p. 738.

KING-FISHER. See Vol. XIV, pp. 81, 82.

KINGLAKE, ALEXANDER WILLIAM, an English historian; born at Wilton House, near Taunton, Somersetshire, Aug. 5, 1809. The family was in affluent circumstances, and his mother, a friend of the younger Pitt, encouraged the boy in outdoor sports and Homeric study. His academic training came through Eton and Trinity College, Cambridge, where he took his bachelor's degree, in 1832. Five years later he was called to the bar at Lincoln's Inn, and he gained considerable chancery practice, though he was independent of professional work. While a law student he traveled in Syria, and wrote an account of his adventures, his fastidious taste demanding nine years of recasting and reflection before he gave it to the public in 1844. Then he guaranteed the publisher against loss, although *Eothen*, with its deft descriptive touch and per-

sistent geniality and delicate sense of what is vital or picturesque, is one of the best books ever written concerning the East. In 1845 he witnessed the relentless campaign of the French against Abd-el-Kader, in Algeria; in 1854 he was with his friend Lord Raglan in the Crimea, as a student of the military art; in 1857 he sat in Parliament for Bridgewater, but a feeble voice prevented his making an impression commensurate with his abilities. He held his seat for eleven years. In politics he was a liberal, and had in detestation the tyrannies of King Bomba in Naples and the usurpations of Napoleon III, especially his annexation of Nice and Savoy to France, in 1860. On the death of Lord Raglan, his widow delivered his papers into Kinglake's hands, and he set about writing *The Invasion of the Crimea*, of which the first volume appeared in 1863 and the eighth and last volume came out twenty-four years later. This was intended to be his great monument, and the book has in its vividness some of the charm of *Boethius*. The field was left to him, but the Crimean war was not an heroic one, and the knightliest affection could not make a hero of Raglan. The prejudices of the author were noble ones, both in his likes and dislikes, but they disqualified him for impartiality. The criticism of Napoleon III was so severe that the sale of the work was prohibited in France during the empire. Died in London, Jan. 2, 1891.

**KINGMAN**, a city and the capital of Kingman County, southern central Kansas, on the Ninescah River, and the Hutchinson and Southern, the Missouri Pacific and the Wichita and Western railroads, 45 miles W. of Wichita. It has abundant water-power, a large planing and lathe mill, a plow and agricultural-implement factory, and a large fire-extinguisher factory. It is the shipping-point for considerable live-stock and grain. Population 1890, 2,390; 1900, 1,785.

**KINGO, THOMAS**. See DENMARK, Vol. VII, p. 90.

**KINGSBOROUGH, EDWARD KING, VISCOUNT**, an Irish statesman and author; born in Cork, Nov. 16, 1795. From 1820 to 1826 he represented Cork in Parliament, and then devoted himself to his great work, *The Antiquities of Mexico, comprising Facsimiles of Ancient Mexican Paintings and Hieroglyphics, together with the Monuments of New Spain by M. Dupaix, with their respective Scales of Measurement, and accompanying Descriptions, the whole illustrated with many valuable inedited MSS.* The first of nine volumes was published in 1831, and the eighth and ninth after his death, which occurred in Dublin, Ireland, resulting from a fever contracted in a debtors' prison, Feb. 27, 1837.

**KING'S BENCH**, same as **QUEEN'S BENCH**. See BENCH, Vol. III, p. 556; RECORDS, Vol. XX, p. 311.

**KING'S OR QUEEN'S COUNSEL** are certain barristers-at-law, in England and Ireland, who have been appointed by letters-patent. The office is entirely honorary, but it gives a right of pre-audience in all the courts, according to the date of appointment. The appointment practically belongs to the Lord Chancellor. See also BARRISTER, Vol. III, p. 394.

**KING'S DAUGHTERS, THE ORDER OF THE, a**

Christian sisterhood of service composed of many small circles of women united in one great organization, now numbering more than 150,000 members. It is a Christian but unsectarian order, and its members may be found in all churches and in almost all nations. It originated in New York City, in 1886, and has spread over nearly every state in the Union, having its representatives in Canada, England, France, Italy, India, Australia, New Zealand and other countries. At first it was intended to limit local branches to ten members, but this was found impracticable and was given up. Its members are bound individually and collectively to serve the needy and the suffering, to consider the poor and to be helpful in good work. Each individual circle may choose its own field of labor, but cannot escape the obligation of service. The badge is a small Maltese cross of silver, engraved with the initials I.H.N. ("In His Name"), often worn with a knot of purple ribbon. The order is an incorporated society, of which this little cross is the seal.

**KING'S EVIL**. See SCROFULA, Vol. XXI, p. 554.

**KINGSLEY, HENRY**, an English author, brother of Rev. Charles Kingsley; born at Holne, Devonshire, England, in 1830. After graduating at Oxford, he went to Australia, where he remained five years. In 1858 he returned to England and remained until he became war correspondent for his own paper, the *Daily Review*, in the Franco-Prussian War. He wrote *Recollections of Geoffrey Hamlyn* (1859); *Ravenshoe* (1861); *Austin Elliot* (1863); *The Hillyars and the Burtous* (1865); and other works. He died May 24, 1876. His daughter, Mary H., a distinguished traveller, scientist, and author, died at Simonstown, South Africa, June 3, 1900.

**KING-SNAKE**, the common name of a snake, known to naturalists as *Ophiobolus getulus*, which the negroes of the southern United States believe to be a ruler over other serpents, and to even destroy the deadly rattlesnake by constriction. It is a beautiful snake, usually black with a series of white rings, hence sometimes known as chain-snake. The color is highly variable, and many varieties have been recognized. The so-called milk-snake is one variety. The king-snake is not venomous.

**KING'S RIVER**, a stream of Humboldt County, northwestern Nevada, rising in Malheur County, Oregon, near the state boundary, and flowing generally southwest, disappearing about sixty miles northeast of Winnemucca. Its valley contains about seventy-five thousand acres of good grazing-ground. It abounds in trout. Length, about two hundred miles.

**KINGSTON**, capital of JAMAICA, q.v., Vol. XIII, p. 550.

**KINGSTON**, a city of southeastern New York, and capital of Ulster County. The city includes the former villages of Kingston, Rondout and Wilbur. It is on the West Shore, the Ulster and Delaware and the Walkill Valley railroads. It is also near the northeast terminus (Eddyville) of the Delaware and Hudson canal, which connects it with the coal region of Pennsylvania. Large quantities of coal are brought here by this canal and reshipped on the Hudson. At Kingston many steamboats are owned, which are

engaged in the river traffic. It has regular steam-boat connection with New York, Albany and many intermediate stations. Kingston is the center of a large ice industry, and does an immense business in making hydraulic cement. It also ships great quantities of bluestone, a metamorphic Devonian sandstone, and an excellent material for flagging. It has good educational advantages and a good-sized public library. Population 1890, 21,261; 1900, 24,535. See KINGSTON, Vol. XIV, p. 89.

**KINGSTON**, a borough of Luzerne County, northeastern Pennsylvania, on the Delaware, Lackawanna and Western and the Lehigh Valley railroads, in the anthracite coal region, and on the north branch of the Susquehanna, opposite Wilkesbarre, with which it is connected by two bridges and an electric street-railway. An imposing monument here erected commemorates the massacre of Wyoming. It is the seat of Wyoming Seminary, a Methodist co-educational institution with 25 instructors and 550 pupils. Population 1900, 3,846.

**KING VULTURE**. See **VULTURE**, Vol. XXIV, p. 302.

**KINKAJOU**. See **MAMMALIA**, Vol. XV, p. 441.

**KINKEL**, JOHANN GOTTFRIED, a German poet; born at Oberkassel, Aug. 11, 1815; was educated for the ministry at Bonn, and preached until 1848, when he became involved in the revolutionary movement and was sentenced to imprisonment for twenty years; through the aid of Carl Schurz escaped and went to America in 1851, but removed to England in a short time, and became professor of German language and literature, first at Hyde Park College, and later at Bedford College. In 1866 he became professor of art history at the Technical Institute of Zurich. He wrote the following poems: *Gedichte* (1843); *Otto der Schütze* (1846); *Nimrod* (1857); and in prose, *Geschichte der Bildenden Künste bei den Christlichen Völkern* (1845). He died Nov. 13, 1882.

**KINMUNDY**, a city of Marion County, southern central Illinois, 229 miles S. of Chicago, on the Illinois Central and the Chicago, Paducah and Memphis railroads. Brick is manufactured here, and farming, especially fruit-raising, and coal-mining are the chief industries of the neighborhood. Population 1890, 1,045; 1900, 1,221.

**KINNIKINICK**, a native name applied to several plants, whose leaves were used by the Indians for smoking with or without tobacco. The name has come to be especially applied to *Arctostaphylos Uva-ursi*, the common bearberry, an ericaceous plant, and to *Cornus sericea*, the common silky dogwood.

**KINSTON**, a town and the capital of Lenoir County, central eastern North Carolina, on the Neuse River (navigable), and on the Atlantic Coast Line and the Atlantic and North Carolina railroads, 30 miles W.N.W. of Newbern. It has manufactories of carriages and plows, and is a shipping-port for cotton. It is in an agricultural region, and has lumber-mills, turpentine distilleries, and carriage and plow factories. Population 1890, 1,726; 1900, 4,106.

**KINTYRE** OR **CANTYRE**, a peninsula of Argyllshire, Scotland, between the Atlantic and the Firth of Clyde, 42 miles long, and  $4\frac{1}{2}$  to  $11\frac{1}{2}$  miles broad. At the north end it connects with the

mainland by the isthmus of Tarbert. The surface is diversified by a ridge of low, moorish hills, with many lochs. Coal is found near Campbelton. A lighthouse, 297 feet above sea-level, stands on the Mull of Kintyre, which is overhung by Ben-na-Lice (1405 feet), and is 13 miles distant from Ireland. Kintyre contains numerous ruins of ancient architecture.

**KIOSK** (Turkish), a small open summer-house or ornamental pavilion used in the East and imitated in the parks and gardens of the West. It consists of a dome or canopy resting on four or more detached columns inclosing an open space. The name is also applied to small shops for the sale of papers in French towns.

**KIOWAS**, a tribe of North American Indians, formerly living from the Platte River southwestward to the Rio Grande, but now confined to a reservation in the southwest part of Indian Territory. They are exceedingly intractable and hard to civilize. In 1895 the Kiowas numbered 1,037. See also **INDIANS**, Vol. XII, p. 832.

**KIP**, WILLIAM INGRAHAM, an American Protestant-Episcopal bishop; born in New York City, Oct. 3, 1811. He graduated at Yale, and in 1835 took orders, and was called to St. Peter's Church, Morristown, New Jersey. He then served as assistant at Grace Church, New York City, and in 1838 became rector of St. Paul's at Albany. In 1853 he was made missionary bishop of California, and four years later bishop. He was author of *The Lenten Fast* (1843); *The Double Witness of the Church* (1844); *The Christmas Holidays in Rome* (1845); *Early Jesuit Missions in America* (1846); *Early Conflicts of Christianity* (1850); *The Catacombs of Rome* (1854); *Unnoticed Things of Scripture* (1868); *The Olden Times in New York* (1872); and *The Church of the Apostles* (1877). He died in San Francisco, April 7, 1893.

**KIPLING**, RUDYARD, an Anglo-Indian author whose virile pen has enshrined the virtues and detailed the failings of the English soldier of the present day, was born in Bombay, India, in 1865. His father, JOHN LOCKWOOD KIPLING, was for many years the head of the Mayo School of Industrial Art at Lahore, and also curator of the Government Museum there. A scholarly, artistic man, his *Beast and Man in India* brought him recognition and fame. Like many another "Baba Sahib," his son, the future laureate of the barrack-room was sent home for his education. If his *Baa, Baa, Black Sheep* be autobiographical, the lot of the keenly-sensitive Anglo-Indian child, always precocious and used to the worship of a score of retainers, was cast in far from pleasant places, in a preparatory school at Southport in Lancashire. It was a fight for existence with young barbarians, in which caste was forgotten and force alone prevailed. After some years at school



RUDYARD KIPLING.

at Westward Ho, in Devonshire, he went out to India in 1880 as sub-editor of *The Lahore Civil and Military Gazette*. Occasional glimpses of his experiences are to be seen in his *In and Out of India*, *The City of the Dreadful Night*, and that masterly short story, *The Man who Would be King*. When others fled to the hills in the heated term, Kipling, amid printer's ink and perspiration, "ran" the paper and filled up a column occasionally with some terse graphic prose. His vacations were spent with Strickland, of the Indian police, whom he has portrayed as an investigator of native character in out-of-the-way places; among the thousand and one smells and dialects of the bazar, and in the depths of the Indian forest, whence sprang later his Mowgli, blood-brother of every beast in the *rukh*.

His genius for doing things in novel fashion showed itself in his first bid for public fame. Collecting his ballads in book-form and in the colored cover peculiar to an Indian Departmental document, he was his own publisher, and reaped a substantial profit from the venture. Official India, wherein, as he sagely remarked, the game of lawn-tennis with the seventh commandment was far from infrequent, had in its midst a new force to reckon with. Living and real were the Bronckhorsts, the Gadsbys, the Mrs. Reivers, the Mrs. Hauksbees and the Venus Annodomini of his pen. More than one Abner had fallen in the van of a hill expedition.

His *Departmental Ditties* (1887) and *Plain Tales from the Hills* (1888) were read from Cabul to Calcutta, and soon traveled across the ocean for English Grub Street first to cavil at, then to admire, and for American publishers to reprint, provoking parodies and imitations all over the land. Then *Soldiers Three* and *Barrack-Room Ballads* limned the red-coated Alexanders at 25 cents a day as neither soldier nor sailor had been depicted before, and won for Kipling the faint praise of the critic and the homage of every English-speaking soldier. He had done for the "Widow's Redcoats" what Captain Charles King had done for the "Boys in Blue." The civilian knew the army regulations better than the adjutant. The man in multi, who felt the pulse of a battalion with keener diagnosis than the doctor or the martinet sergeant-major, and to whom the slang of the cantonment and the incidents of active service were as every-day matters, became the laureate of England's soldiery at a single bound. Marion Crawford alone of all earlier novelists had evoked interest in things Indian. To critics, the empire was a gigantic Nazareth, whence nothing but dry bones could come. Yet here was a spectacled boy reporter of an up-country newspaper, who had set the critics agog with terse phrases pregnant with word painting. To use his own graphic words, "There was a great silence amid the howling of the jackals" when "over the bastions of Fort Amara burst the pitiless day." *Mine Own People*. In *Black and White*, studies of fat and fearsome *babus*, lithe Pathans and lean hillmen, and a few more short stories, preceded his return to England, in 1889, to see "the only perfect, living green in the world" of his father's land, and to sniff, a little dubiously, the incense offered up in his honor by the daily press.

Then came *The Light that Failed*, a gem whose pathos overshadowed all other merits. Next, in a literary partnership and close friendship, *The Naulakha*, by Wolcott Balestier and Kipling, wherein Balestier's tracery of western frontier life stood in the shade of Kipling's daring treatment of things Indian, appeared in the pages of *The Century* magazine, and hardly satisfied those who had hoped for greater things. *Many Inventions* went back to the East for the scenery and subject-matter of many of its short stories, and the same crisp sentences and brilliant word-pictures were again to be seen. Verse in the periodicals came at intervals, grandly patriotic, such as *The Flag of England*, a lyric worthy of a Dibdin or a Macaulay; of it the Winds of the World sing:

"The dead dumb fog hath wrapped it—the frozen dews  
have kissed—  
The naked stars have seen it, a fellow-star in the mist.  
What is the Flag of England? Ye have but my breath  
to dare,  
Ye have but my waves to conquer. Go forth, for it is  
there!"

or pathetic and tender, as his reply to James Whitcomb Riley's gift of a book:

"Your trail lies to the Westward,  
Mine back to mine own place.  
There is water between our lodges—  
I have not seen your face;  
But I have read your verses  
And I can guess the rest,  
*For in the hearts of children  
There is no East or West.*"

There were also brave sea-ballads, such as *The Bolivar* and *The Camperdown*, that epic of the old Scotch engineer, *McAndrew's Hymn*, a noble piece of sustained and strenuous verse, and *The Seven Seas*, a grand interpretation of colonial patriotism.

Marrying the sister of his dead friend Balestier, to whose memory a book and a set of his best verses were inscribed, daring verses indeed, with a far from orthodox description of the great Beyond, where:—

"Cup to lip in fellowship, they gave him welcome high,  
And made him place at the banquet-board, the Strong  
Men ranged thereby,  
Who had done his work, and held his peace, and had no  
fear to die.  
"Beyond the loom of the last lone star through open  
darkness hurled,  
Further than rebel comet dared or hiving star-swarm  
swirled,  
Sits he with such as praise our God for that they served  
his world."

Kipling settled with his bride in the sylvan glades of Brattleboro, Vermont, responding liberally to the demand for short stories and felicitous verse. Later, and in his happiest vein, came the two *Jungle Books*, illustrated by his father's able pen, wherein, after the fashion of Æsop the past-master, the very beasts of the forest talked again. The doings of Bagheera the Panther, the gambols of the Bandar-log, with much lore of Gray Brother the Wolf, Kaa the Python, and Hathi the Silent, in their exploits with Mowgli, their blood-brother, idol of the Seonee pack, were the manliest, most wholesome matters children had read for a century. There was a depth of knowledge of woodcraft, and a subtle ability to describe the moist *rukh* and its myriad denizens, which more than interested grizzled forest officers, who had

grown gray, like Müller, in the depths of India, far from the habitations of men. In all was the solid, terse Anglo-Saxon prose evident, the pen-pictures being the more vivid for their picturesqueness of phrase and virility of style. Kipling had done for India what scores had tried and failed to do. Its essence lived in his pages. His last novel, *Captains Courageous* (1897), dealt with the Gloucester fishermen and their lives on the Grand Banks. Written from close personal study of the scene and the people, it was American in its characters, and in its plot seafaring and adventurous. In the same year appeared his fine poem, *Recessional*; and in 1898 *The Day's Work*, a volume of short stories.

KIPSCHAK, same as *Golden Horde*. See *MONGOLS*, Vol. XVI, p. 746.

KIRATARJUNIYA, the name of one of the celebrated poems of Sanskrit literature. See *SANSKRIT*, Vol. XXI, p. 284.

KIRCHENTAG, an influential association composed of the clergy and laity of the Lutheran, German Reformed, United Evangelical, and Moravian churches in Germany. Its object is to promote the interests of religion, without regard to denominational differences. It holds an annual meeting, the place being changed every year. The first meeting took place in 1848, at Wittenberg, in the church to the doors of which Luther affixed his theses. Its deliberations have a marked influence upon the development of religious thought in Germany.

KIRCHHOFF, CHARLES WILLIAM HENRY, an American mining engineer; born in San Francisco, March 28, 1854. He received his education at the Royal School of Mines, in Clausthal, Germany, 1874; returned to the United States, and became chemist and assistant superintendent of lead-refining works in Philadelphia. He was also connected with several technical magazines in New York, being associate editor of the *Metallurgical Review* (1877); *The Iron Age* (1877-82 and 1886-90); managing editor of *Engineering and Mining Journal* (1882-86); and of *The Iron Age* after 1890. He was special superintendent of the United States geological survey for the collection of lead, copper, and sulphur statistics from 1882, and special agent for the census of 1890 in collecting statistics for lead, copper, and zinc mining and smelting.

KIRCHHOFF, GUSTAV ROBERT, a German physicist; born at Königsberg, March 12, 1824. After studying mathematics and natural sciences in the University of Königsberg, he lectured in Berlin on mathematical physics in 1848, and in Breslau on experimental physics in 1850. In 1854 he was made professor of natural philosophy at Heidelberg, which position he occupied till 1874, when he became professor of natural philosophy in Berlin University. He made researches on electricity, heat, and the tension of vapors, which attracted much attention. But his fame as a physicist is chiefly based on his discovery of "spectrum analysis," which he developed in connection with Bunsen. In 1870 he received the Prussian Order of Merit. Among Kirchhoff's publications are *Untersuchungen über das Sonnenspectrum und die Spectren der Chemi-*

*schen Elemente* (1861); and *Vorlesungen über Analytische Mechanik* (1874). He died Oct. 17, 1887. See also *SPECTROSCOPY*, Vol. XXII, p. 373.

KIRCHHOFF, JOHANN WILHELM ADOLF, a German Hellenist and epigraphist; born in Berlin, Jan. 6, 1826; was educated in Berlin, and became professor ordinarius at the University. He was editor-in-chief of the *Corpus Inscriptionum Atticarum*, to which he contributed a volume; he also wrote *Umbrische Sprachdenkmäler* in connection with Aufrecht (1851); *Studien zur Geschichte des Griechischen Alphabets* (1887); and *Ueber die Entstehungszeit des Herodotischen Geschichtswerkes* (1878). His researches regarding the Homeric poems are of great importance to the student of Hellenic literature.

KIRK, SIR JOHN, a British naturalist; born at Arbirlot, Scotland, in 1833. He graduated M.D. in 1854, and early distinguished himself in botany and other departments of natural history. He served on the medical staff during the Crimean War, and for six years as medical officer and naturalist to Livingstone's second exploring expedition to the Zambesi River. In 1866 he was appointed acting surgeon to the political agency at Zanzibar. He was promoted to be vice-consul at the same place in 1873, and he accompanied the sultan of Zanzibar on his visit to England in 1875. Dr. Kirk materially aided the progress of geographical discovery in East Africa; but his great achievement was the almost complete suppression of the slave trade in the greater part of eastern Africa. In 1875 he was appointed consul in the Comoro Islands; agent and consul-general at Zanzibar in 1880; and in 1890 a Knight Commander of the Bath.

KIRK, JOHN FOSTER, an American historian; born at Fredericton, New Brunswick, March 22, 1824; came to the United States at the age of 18, and from 1847 to 1859 acted as secretary to Prescott, the historian. His publications include contributions to the *North American Review* and the *Atlantic Monthly* and a three-volume history of *Charles the Bold* (1863-68). For fourteen years, from 1871 to 1885, he edited *Lippincott's Magazine*, and then became lecturer on European history in the University of Pennsylvania. He edited the complete works of William H. Prescott (1870-74).—His wife, ELLEN WARNER OLNEY, an authoress, was born in Southington, Connecticut, Nov. 6, 1842; author of *Love in Idleness* (1876); *A Lesson in Love* (1881); *The Story of Margaret Kent*, under the name "Henry Hayes" (1886); and *Sons and Daughters* (1887).

KIRKBRIDE, THOMAS STORV, an American physician; born in Morrisville, Bucks County, Pennsylvania, July 31, 1809; received his medical education at the University of Pennsylvania. In 1832 he was made resident physician of the Friends' Asylum for the Insane at Frankfort, Pennsylvania, and from 1833 to 1835 held a similar position in the Pennsylvania Hospital for the Insane, Philadelphia, from 1840 till his death remaining its superintendent. He was an authority on mental alienations, and published various important works on the care of the insane, including *The Construction, Organiza-*



*tion and General Management of Hospitals for the Insane* (1854); and *Appeal for the Insane* (1854). He was the first in America to place the sexes in separate institutions; was one of the founders of the Association of Superintendents of Institutions for the Insane, and was for eight years president. He died Dec. 17, 1883.

KIRKDALE CAVE, a cave near Pickering, Yorkshire, England, 28 miles W. of Scarborough; discovered in 1821. Its length is 245 feet, but in it there are only two or three places where a man can stand erect. The remains of many tertiary mammals have been discovered in it. The fossil bones are contained in a deposit of mud on the floor of the cave, covered by stalagmites formed by the water dropping from the roof. See also CAVES, Vol. V, p. 267.

KIRKE OR KERTK, SIR DAVID, an English adventurer; born in Deippe, France, 1596, of English parentage. During the Huguenot troubles he went to England; secured vessels there under royal letters of marque, and set out with his two brothers against the French colonies in Canada, besieging Quebec ineffectually. During a subsequent expedition he again laid siege to Quebec, compelling Champlain to surrender the city to him in 1629, though it was returned to France in 1632. At the same time Cape Breton was captured, but afterward ceded to France. He was knighted in 1633, and, with others, received a grant of Newfoundland, of which he was governor for nearly twenty years. Cromwell dispossessed him, but he regained part of his property from Claypole (1653). He died about 1655.

KIRKE, EDMUND. See GILMORE, JAMES ROBERTS, in these Supplements.

KIRKLAND, CAROLINE MATILDA STANSBURY, an American authoress; born in New York City, Jan. 12, 1801. She married William Kirkland, the author, in 1827, and in 1842 established a girls' boarding-school in New York City. Later she became the editor of the *Union Magazine*, which in 1848 was removed to Philadelphia and published as *Sartain's Magazine*. She wrote, among other publications, *A New Home; Who'll Follow?* (1839); *Western Clearings and Essay on the Life and Writings of Spenser* (1846); *Garden Walks With the Poets* (1854); *Memoirs of Washington* (1857); *Personal Memoirs of George Washington* (1858); and *The Destiny of Our Country* (1864). She died in New York, April 6, 1864, having succumbed to overwork induced by efforts in behalf of the great Sanitary Fair of that year.

KIRKLAND, JAMES HAMPTON, an American educator; born in Spartanburg, South Carolina, Sept. 9, 1859; educated at Wofford College, subsequently filling the positions of Latin and Greek tutor and Greek and German professor in that institution; studied in Germany from 1883 to 1886, where he received the degree of Ph.D. Returning to America, he was appointed professor of Latin in Vanderbilt University, becoming chancellor in 1893. In 1885 he published a critique of an Anglo-Saxon poem, *Die Hollenfarht Christi*, and in 1893 edited the *Satires and Epistles of Horace*.

KIRKLAND, JOSEPH, an American author, son of Caroline M. S. Kirkland; born at Geneva, New York, in 1830. He enlisted for the war in the Twelfth Illinois Regiment, served with it in the Army of the Potomac and came out a major. Afterward he studied law and was admitted to the bar, but latterly engaged in literature and became noted for his stories of Western life. Among these are *Zury, the Meanest Man in Spring County* (1887); *The McVeys* (1888), graphic stories of pioneer life in Illinois; *The Captain of Company K*; *The Story of Chicago*; and *History of the Chicago Massacre of 1812*. He died in Chicago, April 29, 1894.

KIRKLAND, SAMUEL, an American clergyman; born in Norwich, Connecticut, Dec. 1, 1741. He received a collegiate degree from Princeton; was ordained to the Congregational ministry in 1766, and commissioned Indian missionary of the Missionary Society, previously having spent 18 months among the Six Nations, acquiring a knowledge of the Mohawk and Seneca tongues, and laboring for upwards of forty years among the various tribes. During the Revolutionary War he became brigade chaplain to General John Sullivan, and was for a time chaplain to the Continental forces at Fort Schuyler and at Stockbridge, Massachusetts. In the early part of the struggle, his good offices among the Six Nations were largely instrumental in securing the neutrality of these tribes, as is attested by a letter of Washington addressed to the Continental Congress in 1775. When peace was declared he resumed his civilizing labors among the Indians. In 1793 he established Hamilton College for the education of American and Indian youth, and founded the town of Kirkland, on land given him by the government. He died Feb. 28, 1808, in Clinton, New York.

KIRKMAN, MARSHALL MONROE, an American author; born in Illinois, July 10, 1842; entered the services of the Chicago and North-Western railroad in 1856, and rose to vice-president and comptroller. He published various works on railways; among them, *Railway Expenditures* (1877); *Railway Disbursements* (1876); *The Baggage, Parcel and Mail Traffic of Railways* (1881); *The Maintenance of Railways* (1886); and *Railway Rates and Government Control* (1892).

KIRKSVILLE, a city and the capital of Adair County, northeastern Missouri, six miles E. of Chariton River, on the Quincy, Omaha and Kansas City and the Wabash railroads, 67 miles W.S.W. of Keokuk, Iowa. The county is well supplied with coal and wood, and has very fertile farming-lands. The village has manufactories of hubs and spokes, woolens, cheese, furniture and plows. The North Missouri State Normal School is located here. Population 1890, 3,510; 1900, 5,066.

KIRKWOOD, a village of St. Louis County, eastern Missouri, on the Missouri Pacific railroad, seven miles W. of St. Louis. It is in a truck-gardening region and has a cartridge-belt factory. Population 1890, 1,777; 1900, 2,825.

KIRKWOOD, DANIEL, an American astronomer and educator; born in Bladensburg, Prince George Co., Md., Sept., 1814. In 1843 he was made principal

of Lancaster (Pennsylvania) High School, and in 1848 of Pottsville Academy. In 1851 he became professor of mathematics in, and in 1854 president of, Delaware College; in 1856 he was made professor of mathematics in Indiana University, in 1866 of Jefferson College, Pennsylvania, and in 1867 he resumed his professorship at Indiana. In his most important work, *The Nebular Hypothesis and the Approximate Commensurability of the Planetary Periods*, he applied the Laplace theory to explain the hiatus in the ring of Saturn and the gaps in the zone of the minor planets. He wrote, also, *Meteoric Astronomy* (1867); *Comets and Meteors* (1873); and *The Asteroids* (1887). He died at Riverside, Cal., June 11, 1895.

KIRKWOOD, SAMUEL JORDAN, an American statesman, cousin of the preceding; born in Harford Co., Md., Dec. 20, 1813; received but little education, and was employed as a drug clerk (1827-34); removed to Ohio (1835), and having studied law, was called to the bar in 1843; he practiced his new profession until 1855, when he went to Iowa. In the next year he served in the Iowa state senate, and in 1859 was elected governor. Re-elected in 1861, he became known as one of the great "War Governors," and by his energy in raising troops, Iowa was enabled to fill her quota without resorting to the draft. His prudent management saved his state \$500,000 out of the funds appropriated for defense bonds. In 1866 he was elected United States Senator, in 1875 was for a third time governor of Iowa, and in 1876 was re-elected to the Senate. He resigned in 1881, and from thence till April, 1882, was Secretary of the Interior in Garfield's cabinet. Died in Iowa City, Sept. 1, 1894.

KIRMAN OR KERMAN, the capital of Kirman province, Persia, 225 miles N. by E. of Bander Abbas, its port on the Persian Gulf, in a plain surrounded by mountains; is enclosed by a mud wall, and has a citadel; is the great trade centre between the Persian Gulf and northern Persia and central Asia; has many fine bazars, and manufactures shawls, cotton carpets, silk goods, and matchlocks; has been frequently sacked and destroyed by invaders, the last time in 1794, by Agha Mohammed Khan. Population about 45,000.

KIRMESS, See KERMESSE, these Supplements.

KIRN, a town in Rhenish Prussia, on the Nahe river, 40 miles S. of Coblenz; manufactures woolens and fine leather. Population 1895, 5,638.

KIRRIEMUIR, a market town in Forfarshire, Scotland, near Prosen Water, 5 miles N.W. of Forfar; has handsome churches, schools, a trades' hall, and a bank; manufactures brown linen, sheeting, and dowlas. Near by is Inverquharity castle. The town is the "Thrums" of J. M. Barrie. Pop. 1891, 4,179.

KIRSANOF, a town in Tambov government, Russia, 60 miles E. of Tambof; has a large trade in grain, hides, and cattle. Population 7,193.

KIRTHAL, a town in Meerut district, Northwest Provinces, India, 32 miles N.W. of Meerut. Population 1881, 5,500.

KIRTLAND, JARED POTTER, American physician and naturalist, born in Wallingford, Conn., Nov. 10, 1793. He obtained his early education at Wallingford and Cheshire, Conn., becoming a student in

botany and fruit and flower culture. In 1811-13 he was a medical student at Edinburgh, but in 1813, on account of the war with Britain, entered the medical department at Yale, where he graduated in 1815. In 1815-23 he practiced his profession in Connecticut, and in 1823 removed to Ohio. In 1828 he was elected to the legislature, and served three terms. In 1845 he was one of the founders, and the first and only president, of the Cleveland Academy of Science, which in 1865 became the Kirtland Society of Natural History. He was also one of the founders of Cleveland Medical College, in which, up till 1864, he was professor of the theory and practice of medicine. He was also president of the Ohio Medical Society. During the war he was examining surgeon of recruits at Columbus and Cleveland, and gave his salary to the bounty fund and to the Soldiers' Aid Society of northern Ohio. His chief discovery in natural history was that of the sexual differences in the naiades, showing that the male and female can be distinguished by the forms of the shells as well as by their internal anatomy. Died in Cleveland, Dec. 10, 1877.

KIRUMBO, a Madagascar bird, *Leptosomus discolor*, the only surviving member of the family *Leptosomidae*. The male is glossy green above, and gray beneath and on the sides of the head and round the neck; the female has blackish and reddish-brown spots and bars. The birds live in wooded land, in small flocks, and have the habit of tumbling in the air from a great height, like the rollers (*Coracias*).

KIRWIN, a city in Phillips Co., Kansas, on the north fork of the Solomon river, 15 miles S.E. of Phillipsburg; has a U. S. land office, 2 hotels, 2 newspaper offices, banks, elevators, and flour mills. Population 1890, 689; 1900, 586.

KISHANGARH, a walled town, the capital of the native state of Kishangarh, Rajputana, India, 18 miles N.E. of Ajmir. Population 1891, 15,457.

KISHANOWADA, a seaport town in Hondu Island, Japan, 50 miles S.S.W. of Kyoto. Population 1887, 12,879.

KISHON, a torrent of central Palestine, rising near Mount Tabor, in lat. 32° 30' N., long. 35° 30' E. It flows northwest and empties into the Bay of Acre, just north of Mount Carmel. It was the scene of the defeat of Sisera (Judg. iv) and of the destruction of the prophets of Baal by Elijah (1 Kings, xviii, 40). The modern name is Nahr-el-Mukatta, *i. e.* "the river of slaughter."

KISHORGANJ, a town in Maimansingh district, Dacca division, Bengal, India, 50 miles N.N.E. of Dacca. Population 1891, 13,988.

KIS-KÖRÖS, a town in Pest-Pilis-Solt-Kis-Kun Co., Hungary, 25 miles W. by S. of Felegyhaza; produces good wine. Population 1890, 7,878.

KISLINGBURY, FREDERICK FOSTER, an American army officer and Arctic explorer; born at Hlsley, near Windsor, England, Dec. 25, 1847. When he was quite young his parents brought him to America, and settled in Rochester, N. Y. In 1863 he enlisted in a cavalry regiment and served for two years, till the end of the Civil War, after which he was chief clerk of the Department of the Lakes, at Detroit. A few years later he was given command of a band of scouts to fight the Indians; and still later served on

the plains as second lieutenant of the 11th Infantry. In 1881-84 he was second officer of the Greely Arctic expedition, and died of starvation at Cape Sabine, Ellesmere Land, June 1, 1884, being one of the last members of that ill-fated expedition who succumbed. His body was brought home and buried at Mount Hope cemetery, Rochester. He was a Knight of Pythias, and in Rochester a new lodge was founded in honor of his memory.

KISMAYU, a seaport in British East Africa, near the mouth of the Juba river; has an excellent harbor, with good anchorage. Population about 1,000.

KISMET (Turkish, *quismet*; Persian, *quismat*; "lot," or "fate," or "destiny"), an Oriental word meaning man's fate or destiny, or lot in life, or any event or episode in it; the fulfillment of destiny.

KISS, AUGUST, a German sculptor; born at Pless, Prussian Silesia, Germany, Oct. 11, 1802; educated first at the Royal Foundries at Gleiwitz, later with the eminent sculptor Rauch (q. v. Vol. XX). After producing some creditable bas-reliefs, groups, and other decorations for Schinkel's famous Charlottenhof fountains he gave the measure of his talent in his group *The Amazon and the Panther* (1839), which created such enthusiasm that it was cast in bronze by public subscription. It is now on the steps of the Berlin Museum. A plaster cast of it took the first prize in the London exhibition in 1851, and was bought by an American, and exhibited in New York in 1853. Among his best-known works are an equestrian statue of Frederick the Great, at Breslau; two statues, one equestrian and colossal, of Frederick William III, at Königsberg; a *St. Michael and the Dragon*, presented to Frederick William IV; and a colossal statue of St. George, now in the court of the palace in Berlin. Kiss left a strong and wholesome mark on the development of modern German sculpture. He died in Berlin, March 24, 1865.

KISS, JOSEPH, an Hungarian poet, born at Temesvár, in 1843. Since 1890 he has been editor of *The Week*, a literary paper. His poems have the note of modernity, with a strain of melancholy. Among the most notable are *A Song of the Sewing Machine* (1884), a eulogy on woman and a glorification of work; and *A Grave* (his mother's). A fourth edition of his *Poetical Works* appeared in 1890; and *New Poems* in 1891.

KISSA, a volcanic island, one of the Banda Islands, Malay archipelago, Dutch East Indies, N. E. of Timor; 20 miles in circumference; is low, sandy, and rocky, and enclosed by a coral reef. Population about 10,000.

KISSAR, a five-stringed lyre used by the Abyssinians and other people of northern Africa; it is similar to an instrument represented as being played by captives in Assyrian bas-reliefs.

KISSIMMEE, a city, the capital of Osceola Co., Fla., 70 miles E. N. E. of Tampa, in an orange-growing district; early vegetables for northern markets are raised; has sugar-refineries and rice-mills. Population 1890, 1,086; 1900, 1,132.

KIS-TELEK, a town in Csongrad Co., Hungary, 18 miles N. by W. of Szegedin. Pop. 1890, 7,459.

KIS-UJSZÁLLÁS, a town in Jasz-Nagy-Kun-Szolnok Co., Hungary, 45 miles W. S. W. of Debreczen. Population 1890, 12,527.

KIS-VÁRDA, a town of Szabolcs Co., Hungary, 54 miles N. N. E. of Debreczen. Pop. 1890, 6,458.

KITAH, a town in Bokhara, central Asia, on the Kashka river, 38 miles S. of Samarkand. Population about 15,000.

KITAIBELIA, a genus of plants of the order *Malvacea*, tribe *Malveæ*, subtribe *Malopeæ*, distinguished from *Malope* by having the style stigmatic at the apex, and from other genera by its 6 to 9 bracts united at the base. It has only one species, *K. vitifolia*, the vine-leaved Kitaibelia, a native of Hungary, along the Danube, where its leaves are used as a vulnerary. It is a rough, hairy, perennial herb, two or three feet high, clammy above, with five-lobed leaves and whitish flowers an inch and a half across. It was named after Dr. Paul Kitaibel, of Budapest.

KITCHEN CABINET, a coterie of political advisers of President Jackson, who were said to influence his policy more than his cabinet did. The chief members were Francis P. Blair, editor of the *Washington Globe*, the organ of the Democratic party from 1820 to 1845; General Duff Green, editor of the *Washington United States Telegraph*, another organ of the administration; Isaac Hill, editor of the *New Hampshire Patriot*; Amos Kendall, of Kentucky, fourth auditor of the Treasury; and Major William B. Lewis, of Nashville, Tenn., second auditor of the Treasury. "They were men," says Mr. Schouler, in his *History of the United States*, vol. iii., p. 495, "with whom he could smoke and converse at random, without the constraint of a council and clashing minds." It was called "Kitchen" because separate from the cabinet proper, and lacking in public dignity and authority.

KITCHENER of Khartum. Horatio Herbert Kitchener, first Baron of Khartum (created 1898), and since 1892 Sirdar of the Egyptian army, was born in 1850. He is the eldest son of the late Lieutenant-Colonel Kitchener, and was educated at the Royal Military Academy, Woolwich, England. He entered the British army in 1871, and three years later was employed in the Palestine and Cyprus surveys. In 1882, on his release from this duty, he



HORATIO H. KITCHENER.

served as a major of cavalry in the Egyptian army, accompanied the Nile Expedition in 1884, and became governor of Suakin in 1886. For his bravery in the action of Handub in 1888, when he led the Egyptian troops against Osman Digna, he was made aide-de-camp to the Queen; and in the subsequent fighting in the Sudan he was mentioned in despatches and made a Companion of the Bath. From 1888 till 1892 he held the rank of adjutant-general in the Khedival army, and in the latter year was appointed Sirdar. After the taking of Dongola, in 1890, he was made a K. C. B., and in

the subsequent effort to "smash the Mahdi's forces" in the Sudan and recover the territory for Egypt and civilization, he won honors and fame. The Conservative government of Lord Salisbury having decided to regain Khartum, which was lost when General Gordon fell, General Kitchener was instructed to organize a strong and effective force, including a few British troops and some 20,000 Egyptian and Sudanese soldiery, and to proceed against the Dervishes under the Khalifa. At this period the Egyptian frontier did not extend beyond Wady Halfa, so there was much to do to organize and push on the new expedition, both by the Nile and over the deserts. The reconquest of the Sudan began March 19, 1896, and before the end of September the Dervishes had been defeated at Ferket, Suarda occupied, the battle of Hafir won, and the Sirdar's army had entered Dongola. About a year later Abu Hamed was captured and Berber was occupied by friendly tribes. In October, 1897, the railway from Halfa to Abu Hamed was completed, and the gunboats of the expedition engaged the enemy's forts at Metemneh. In March, 1898, Shendy was captured; and on April 8, 1898, the Dervishes were completely defeated at Nakileh, on the Atbara, and Mahmud, the Khalifa's right-hand man, was taken prisoner. By August, 1898, the advance was within 30 miles of the Khalifa's capital, Omdurman, opposite the site of Khartum. It included British, Sudanese, and Egyptian infantry and cavalry, a camel corps, and some mounted infantry, with strong batteries of Maxim guns, howltzers, and 40-pounders; the total number being about 25,000. Opposed to the Sirdar was a force of fanatical Dervishes, numbering fully 50,000, which had taken up position near Omdurman. On September 2, 1898, this force was descried in the desert northwest of the town, drawn up in five divisions, with a wing thrown back, its spears and swords glistening in the early morning sunshine. With magnificent courage it at once advanced to attack the brigades of the Sirdar, only to be routed or driven back, and mowed down by the steady rifle fire of the infantry, and by the Maxim guns and the shells fired from the British gunboats on the river. The slaughter was frightful, as the onset was a determined one and the attacks were madly repeated by the various portions of the Khalifa's army. The Dervish loss is supposed to have exceeded 11,000 killed, 16,000 wounded, and 4,000 prisoners. The Khalifa escaped from the battlefield with a small following, while the Omdurman forts were silenced and the town was occupied.

For achieving the victory, General Kitchener was awarded a peerage, as Baron Kitchener of Khartum and of Aspall, in the English county of Suffolk; and on his return to England in October, 1898, he was given an enthusiastic reception and presented with the freedom of the City of London and a sword. While in England Lord Kitchener was instrumental in raising a fund of half a million dollars to found and endow a Gordon Memorial College at Khartum for the instruction of Egyptian and Sudanese youth. In Jan., 1899, he was appointed Governor-General of the Sudan.

From this post General Kitchener was withdrawn, towards the close of the year 1899, to

accompany Lord Roberts as his chief of staff in the Boer war. In the operations against the Boers he has had the duty of organizing and conducting the military transport service in South Africa.

KITCHEN-MIDDENS OR SHELL-HEAPS, prehistoric mounds of shells and refuse. See ANTHROPOLOGY, Vol. II, p. 116; and ANDAMAN ISLANDS, Vol. II, p. 11.

KITCHIN, GEORGE WILLIAM, D. D., an English clergyman and historian; born at Naughton Rectory, Suffolk, Dec. 7, 1827; Dean of Winchester, 1883-94; Dean of Durham since 1894. He wrote *History of France* (3 vols., 1873-77); *Life of Pope Pius II* (1881); *Winchester* (1890), etc.

KITE, a bird of prey. See Vol. XIV, pp. 103-04.

KITES AND KITE-FLYING. Kite-flying, in the minds of the majority of persons, is but an innocent sport for the amusement of children. In recent years the art has come into skillful use as a means of solving certain scientific problems. Benjamin Franklin's famous kite, with which he won from the skies some of the secrets of electricity, is recorded in history. When the Niagara suspension-bridge was in course of construction, after the towers had been built, the problem of stretching the first wire of the cables was solved by the aid of a kite, which carried a line across the river, and this line, in turn, was used to draw over the first wire. Since 1880 experiments have been performed repeatedly to devise methods for taking meteorological observations by means of self-recording instruments carried to the upper air strata by kites. Among those who have developed the kite as an aid to science are W. A. Eddy, at Bayonne, New Jersey; Hargrave of Australia; Dr. A. B. Johnson, of New York city; J. Woodbridge Davis; and Alexander McAdie of Blue Hills, Massachusetts. The kite used generally in experiments, of which those of W. A. Eddy are representative, is not the traditional triangular kite with a tail, but is a convex-surface contrivance, which flies without a tail, and of which the construction is the result of much study of every detail. Two sticks of some light wood are crossed at a point 18 per cent below the top of the one which is to be the upright; the sticks are tied, not nailed; the horizontal stick is bent back in a bow shape, and fastened by a cord attached to the ends; the centre of this cord must be at a distance from the crossing-point of the two sticks equal to one-tenth of the length of the cross-stick; a fine wire is passed around the whole, in notches at each end of the two sticks; a light paper or cloth is then stretched over the framework and pasted at the edges around the wire; the lower portion of the paper must be loose, so that the two parts below the cross-stick will be concave and the upper portion above the cross-piece convex; cords are then attached at the crossing-point and at the lower end of the vertical stick; these cords are joined and so arranged that when the kite is in the air the main cord will make an angle of 70° with the earth. Kites of this kind can be flown to great heights, and in tandems of from six to eight planes, upon one main cord. Another kind of kite, invented by Hargrave, consists of an oblong box open at both ends, constructed of very

light material, and elevated by the suction of the wind. Tandems of the latter kind of kites have a strong pulling-power, in one recorded instance lifting a man from the ground to a height of twelve feet. Kites of both kinds will fly in any wind. Owing to the large lifting-power, automatic instruments can be sent up and observations taken. Valuable meteorological investigations have been made, and by means of such kites weather prognostications are made regularly by Mr. Eddy. On Oct. 8, 1896, at the Blue Hills Observatory, by means of a tandem of seven Eddy and two Hargrave kites, a self-recording meteorograph, run by clockwork, was sent up 9,385 feet, requiring over three miles of wire. Accurate observations were taken at this the highest recorded altitude then reached by a kite. The pull varied from 20 pounds at the start to 95 pounds at the highest point. Another use of the kite is in photographing large extents of country by means of a camera carried up by the kite and regulated from the ground. Views of parts of New York City have been secured in this way. The kite-buoy is used on the Atlantic Coast. A kite of the first kind described is attached to a buoy so arranged with a keel that it will travel through but not leave the water when dragged by the kite. This is used by wrecked vessels for sending messages or lines ashore. A third kind, known as the "aërophile," has been designed more recently. The frame resembles an umbrella, is made of metal, and, like the umbrella, will fold. The covering is cloth, and a tail is attached, which consists of several ribbons, with pockets at their extremities. In these pockets, weights can be placed to regulate the kite's ascension in accordance with the force of the wind. It has large buoyancy, but thus far is hardly more than a scientific toy. As improvements are made in the kite and kite-flying apparatus it will be made to play an important part in scientific work. See AERONAUTICS, in these Supplements.

**KIT-FOX** (*Vulpes velox*), a small reddish-gray fox which lives in burrows on the prairies of the western United States. It ranges from Oregon to Missouri. The name was given by Lewis and Clark. It often is called burrowing-fox and swift-fox, but the latter designation is a misnomer, for the animal is not rapid in its movements. The nearest relative of this fox is *V. corsac*, which inhabits the plains of Asia.

**KITTANNING**, a borough and the capital of Armstrong County, western central Pennsylvania, on the Allegheny River, 43 miles above Pittsburg, and on the Allegheny Valley railroad. It contains a rolling-mill, oil-refineries, woolen-mill, blast-furnace, and a pottery. It is the site of a college, an academy, a school of telegraphy and typewriting and other institutions of learning. It is in a coal and iron mining region and has an abundance of natural gas. Population 1890, 3,005; 1900, 3,902.

**KITTATING MOUNTAINS**, a range in northern New Jersey, running through Sussex and Warren counties. The Delaware River runs parallel with them, from three to five miles to the west. The ridge is characterized by its even outline, there being very few peaks. They do not exceed 2,400 feet in height. The Delaware Water Gap, which divides them from

the Blue Ridge in Pennsylvania, is a beautiful spot. They are composed of rocks of Silurian formation, mostly Medina sandstone and Oneida conglomerate.

**KITTIWAKE**. See GULL, Vol. XI, p. 274.

**KIU-KIANG**, a walled city and treaty port of Kiangsi province, eastern China, on the Yang-tse-Kiang, 445 miles W. of Shanghai and 480 miles N.N.E. of Canton. Its foreign trade amounts annually to about \$12,500,000, of which nearly two thirds represent local exports. The principal exports are chawaware, grass-cloth, hemp, paper, rice, tobacco and tea. It is surrounded by a wall six miles in length. Population 1874, 35,000; official estimate of 1898, 55,000.

**KIUSHIU OR KYUSHU**, the most southerly of the three principal islands of Japan. It is separated from Corea by the Straits of Corea, and from Honshiu Island by the Strait of Shikoku. Its area is 13,767 square miles; including the smaller adjacent islands, 16,840; entire population, 1898, 6,357,551.

**KIZIL-IRMAK OR HALYS RIVER**. See ASIA MINOR, Vol. II, p. 707.

**KLACZKO, JULIEN**, a Jewish author; born at Wilna, Lithuania, Nov. 6, 1828. After receiving at the Königsberg University his Ph.D. in 1846, he became one of the writers for the *Revue des Deux Mondes* in Paris. In 1869 Count von Beust, Chancellor of Austria, called him to a position in the Council of State, which he resigned in 1870 on account of ill health. His most noted work is *Les Deux Chanceliers*, a bitter attack upon Bismarck and Gortschakoff, which created a great sensation. He also published *La Poésie Polonoise au XIXe Siècle* (1862); *Correspondence of the Polish Poet, Mickiewicz* (1861); and *Causeries Florentines* (1880), crowned by the French Academy. He was elected a corresponding member of the French Institute.

**KLAPKA, GYÖRGY**, a Hungarian soldier and patriot; born at Temesvar, April 7, 1820. In 1842 he entered the Imperial Life-Guards of Austria, and in 1847 he became an officer in one of the frontier regiments. In 1848 he joined the Hungarian revolutionary army, where he distinguished himself so much that he was placed at the head of an army corps in 1849. Under Görgei he contributed to several victories over the Austrian troops, most particularly at Komorn, where his efforts opened the way to Vienna. He was called to Debreczin by Kossuth and made Minister of War, taking sides with the people against the ultra-aristocratic Hungarian party. He sustained valiantly the siege of Komorn, until the defection of Görgei rendered his efforts useless. However, Marshal Haynau, the besieger, was forced to consent to a free withdrawal of the besieged, with flags floating and the honors of war. He took refuge in England, and during the Franco-Austrian war endeavored to operate a diversion in favor of Hungary. In 1866 he raised a Hungarian legion to fight against Austria, but in vain. When Austro-Hungary was reconstructed in 1867, he was permitted to return to his native land, where he was elected a Deputy and helped in reorganizing the army. In 1877 he was called to Constantinople with a view to reorganizing the Ottoman army against the Russians. Having succumbed

to local intrigues, he was obliged to give up his plans and return home. He published *Memoirs of the War of Independence in Hungary*; *The National War in Hungary and Transylvania*; and *The War in the East* (1855). Died in Budapest, May 17, 1892.

KLAPROTH, MARTIN HEINRICH, a German chemist; born at Wernigerode, Saxony, Dec. 1, 1743; began life as an apothecary's apprentice and clerk, employing his leisure in acquiring a thorough knowledge of chemistry, and publishing a number of valuable analyses; made professor of chemistry at the Berlin School of Artillery in 1787 and at the University in 1789. He discovered the metals zirconium, titanium, and uranium. His method of analysis assisted greatly the proper classification of minerals. An enthusiastic believer in the theories of Lavoisier (q. v.), he was made a corresponding member of the French Institute. He edited a *Chemical Dictionary* (5 vols., 1807-10), wrote a *Chemical Manual*, and contributed a number of papers to the *Denkschriften* of the Berlin Academy. He was the father of HEINRICH JULIUS VON KLAPROTH, the Orientalist (q. v.). Died in Berlin, Jan. 1, 1817.

KLEBS, ERWIN K., a German physician and educator; born at Königsberg, Prussia, Feb. 6, 1834; studied successively at the universities of Würzburg, Jena, and Berlin, where in 1861 he became assistant to Virchow at the Pathological Institute; professor of pathological anatomy at the Bern University in 1866; surgeon in the Prussian army in 1870-71; but at the close of the war returned to Switzerland to care for the typhus-stricken soldiers of Bourbaki's army, who had taken refuge in that country. He became well known for his studies on diphtheria, smallpox, and gunshot wounds. He was successively professor at the Würzburg, Prague, and Zurich universities. He wrote *Handbuch der pathologischen Anatomie* (1867-78); *Beiträge zur pathologischen Anatomie der Schusswunden* (1872); *Studien über die Verbreitung des Kretinismus in Oesterreich* (1877), *Ueber die Umgestaltung der Medicinal-Anschauungen in den letzten drei Jahrzehnten* (1877).

KLEIST, EWALD CHRISTIAN VON, a German soldier and poet; born at Zebbin, Pomerania, March 7, 1715. After a course of classical studies he entered the Danish army in 1736, and later joined the Prussian army under Frederick the Great. His close intercourse with Gleim, Nicolai, and Lessing (q. v.) excited his poetic talents, and his reputation soon spread through Germany. In 1756 he published an edition of his collected poems. Among these, *Der Frühling* (*Spring*) is considered his best, though obviously inspired by Thomson's *Seasons*. A few months before his death at Frankfort-on-the-Oder, Aug. 24, 1759, from a wound received at the battle of Kunersdorf on Aug. 12, he published a volume on military tactics.

KLEIST, HEINRICH BERNT WILHELM VON, a German poet and playwright; born at Frankfort-on-the-Oder, Oct. 18, 1777. When a young man he served in the army against Napoleon, and afterward was employed in the civil service. He was taken prisoner by French troops, and kept in France for

a year (1805-06). He committed suicide at Wannensee, near Potsdam, Nov. 21, 1811. He wrote the following dramas: *Die Familie Schroffenstein* (1803); *Penthesilca* (1808); *Käthchen von Heilbronn* (1810); *Der Zerbrochene Krug* (1811); *Der Prinz von Homburg* (1821); and *Die Hermannschlacht* (1821). Among his novels the best undoubtedly is *Michael Kohlhaas*.

KLLENZE, LEO VON, a German architect; born at Hildesheim in 1784. After studying his profession in Berlin, he traveled extensively in Italy and France; became court architect to King Jerome of Westphalia, Napoleon's brother (1812); and Bavarian court architect in 1815, and settled at Munich. There he built the Glyptothek, the Pinakothek, the Odeon, and an extension to the Royal Palace, monuments of lasting beauty; also the Walhalla at Ratisbon, and the Imperial Museum, St. Petersburg, and was invited by King Otho of Greece, a Bavarian prince, to visit Athens and improve its public buildings. His great merit was his tenacious fidelity to the great principles of classical art at a time when a general upheaval seemed to overturn all the old principles. He was a member of nearly all the art academies in Europe. Died at Munich, Jan. 27, 1864.

KLEPTOMANIA. See CRIME, Vol. VI, p. 584.

KLICPERA, VÁCLAV KLIMENT, a Bohemian playwright; born at Chlumeck, Bohemia, Nov. 23, 1793; graduated in philosophy and medicine from the Prague University, but devoted himself to teaching and literature; professor at the gymnasium of Králové Hradec in 1819; president of the Prague Academic Gymnasium in 1851. He wrote a large number of novels and dramas of very unequal worth. His best dramatic efforts are *The Wonderful Hat*; *The Four-Cornered R.*; and *The Liar and his Family*. His historical tragedy, *Sebeslav*, is his best serious work. Died in Prague, Sept. 15, 1859.

KLIEFOTH, THEODOR FRIEDRICH DETLEV, a German Lutheran divine; born at Körchow, Mecklenburg, Jan. 18, 1810; studied theology in Rostock and Berlin; is considered a high authority on Lutheran liturgies; occupied after 1850 the high office of superior consistorial counselor for Mecklenburg-Schwerin. He wrote his exhaustive *Liturgische Abhandlungen* (8 vols., 1859-69); *Eschatology* (1885); a *History of Dogmas*; and commentaries on several prophets and on Revelation.

KLIKITAT INDIANS, a small tribe of Indians belonging to the family of Shahaptian Indians, who once occupied a large tract of country along the Columbia river; to the same family belongs the tribe of the Nez-Percés. It is known that the Klikitat tribe torched the Columbia between 1820 and 1830, and, crossing the Willamette valley, overran the Umpqua valley, Oregon. But they were soon compelled by the Chinook Indians to retire to their own country, on the other side of the Cascade Mountains. In 1866 they were found—hardly over 100 in number—in the prairie country at the foot of Mount Hood, Wash., between Vancouver and The Dalles.

KLINGER, FRIEDRICH MAXIMILIAN VON, a German soldier, novelist, and playwright; born at

Frankfort-on-the-Main, Feb. 17, 1753; educated at the University of Giessen; entered the Austrian army in 1778; passed to the Russian service in 1780, where he rose to the rank of lieutenant-general in 1811. Early in life he found himself under the literary influence of Goethe; his first drama, *Sturm und Drang* (1776), is descriptive of the new literary era founded by Goethe and Herder. His best-known novels are *Faust's Life, Deeds, and Journey to Hell* (1791), and *The Worldling and the Poet* (1798). He also wrote *Reflections and Thoughts on Various Subjects of the World and Literature* (3 vols., 1802-05). Died at Dorpat, Feb. 25, 1831.

KLONDIKE (a corruption of the Indian name, "Thron-diuck," that is, "river with plenty of fish"), a river and gold-bearing region in Yukon district, Canada. The river is about 150 miles long, and flows into the Yukon from the east at about 64° 5' N. lat., six miles above old Fort Reliance, now in ruins. Its source is in a high range of mountains, which forms the water-parting between its basin and that of the Stewart river, to the south. An island divides its mouth into two channels, each about 150 feet wide and four or five feet deep. The stream is clear and shallow, and very swift, with numerous rapids, which make it difficult of navigation for canoes. Its waters afford excellent salmon fishing, and the work of catching and drying the fish is a profitable industry for the Indians. Among its affluents coming in from the south are Bonanza Creek, Bear Creek, Hunker Creek, Too-Much-Gold Creek, and All-Gold Creek, on all of which gold has been discovered. Indian River flows into the Yukon from the east about 30 miles above the Klondike, its chief affluents being Quartz, Dominion, and Sulphur Creeks, on all of which also gold has been discovered. Still further south is Henderson Creek, another gold-bearing stream, which enters the Yukon from the east about 15 miles above Indian River. Indian River and Henderson Creek, though not a part of the Klondike river system, may be considered as belonging to the Klondike district.

**GOLD MINING.** The first discoveries of gold in paying quantities in the Klondike district were made in August, 1896, by two men, named Henderson and George W. Cormack. These discoveries were made on an affluent of the Klondike to which Cormack gave the name of Bonanza Creek. On Nov. 3, 1896, a rich strike was made on this creek, the first pan (two shovelfulls) yielding 35 cents, and the next seven pans averaging \$3.35 each. From this strike dates the Klondike "boom." Other strikes were made, and by October, 1897, Bonanza Creek had been staked out for a distance of 20 miles from its mouth. In September, 1896, strikes were made on Eldorado Creek (an affluent of Bonanza) and on Hunker Creek, an affluent of the Klondike. By the first week in June, 1897, when the season's work closed, gold to an estimated value of from \$2,000,000 to \$4,000,000 had been taken out by about 600 men; and by the end of the summer, in September, 1897, the amount had been increased by another \$1,000,000. The highest price paid for the purchase of a single claim was \$55,000. The output for the following season, 1897-98, was estimated at \$9,000,000, as follows:

Eldorado, \$4,000,000; Bonanza, \$3,000,000; Hunker and Bear, \$1,000,000; Dominion, Sulphur, and all other creeks, \$1,000,000. This estimate of \$9,000,000, however, is probably \$2,000,000 below the actual output. It is expected that the output for the season of 1898-99 will be double that of 1897-98. By many of the miners Eldorado Creek is considered to be the richest placer district ever worked in the world. From its mouth to claim 38, four miles up the river, every claim has proved to be uniformly rich, not one being worth less than \$200,000, and some being worth a good deal more. And according to results yielded in the latter part of 1898, Dominion Creek (an affluent of Indian River) promises to turn out as rich as, if not richer than, Eldorado Creek. Paying diggings have also been discovered on Henderson Creek. During the winter of 1897-98, also, some rich strikes were made on an island in the Yukon, about 10 miles above Dawson, to which the name of Monte Cristo was given. As high as \$8 was found in a single pan. This discovery caused a good deal of excitement, and all the islands in the Yukon for from 15 to 20 miles above and below Dawson were speedily staked. Outside of and some 400 miles to the south of the Klondike district another gold-bearing region has been discovered in northwest Canada, in the neighborhood of Lake Atlin, a sheet of water about 50 miles long and three or four miles wide, lying partly in British Columbia and partly in Yukon district, and between Lake Tagish, on the west, and Lake Teslin, on the east. This region is nearer and more accessible than the Klondike, and there will probably be a rush to it during the present season (1899). In the fall of 1898 an active volcano, in full eruption, about 14,000 feet high, was discovered in the Atlin district.

Under the Canadian mining regulations claims in the Klondike district are limited to 250 feet along the general course of a stream. The discoverer is allowed to locate two claims, or 500 feet. Every alternate ten claims are reserved to the government; that is, when a claim is located, the discoverer's and nine other adjoining claims are open for registration, then the next ten claims are reserved to the government. A prospector can locate but one claim in a district, and he must certify under oath that he has found gold in paying quantities. This gives a fair chance to all, as it prevents speculators from taking up claims before they have been properly prospected, and for the mere purpose of selling again. A royalty of ten per cent is collected on the gross annual output of each claim, \$2,500 being first deducted from the gross annual output. The gold commissioner's fees are: miner's license, \$10; location notice, \$15; transfer, \$2; mortgage, \$2; partnership agreement, \$5.

The method of placer mining in the Klondike district is usually as follows: The ground throughout the Klondike has a covering of moss to a depth of from 12 to 18 inches, beneath which there is a deposit of decayed vegetation called by the miners "muck," which varies from 2 to 30 feet in depth. This "muck" is frozen solid from its surface just beneath the covering of moss down to the frozen gravel, which is generally struck at a depth of 10 or 15 feet, though sometimes not till a depth of 25 or

30 feet is reached. It is in this gravel that the gold is found. The summer heat has no effect on the layer of frozen earth or "muck," until the moss is removed. This layer of moss is therefore stripped off, and the miner, with a pick, sinks a shaft, about 6 feet long by 3 or 4 feet wide, through the frozen earth till he reaches the gravel. This frozen gravel is so hard that it turns the point of the best pick in five minutes. The miner therefore thaws out the gravel by "burning"; that is, he builds a fire at the bottom of the shaft, and when the gravel is thawed out to the depth of about 2 feet, he shovels it out and, with a windlass, hoists it to the surface, where the gold can be washed out. This process of thawing and shoveling out the gravel is called "drifting," and it can be continued downward till bed rock is reached. This work is best done in winter, because in summer the flow of water into the shaft prevents work at the bottom. Shallow claims, where a shaft is not necessary, can be worked in summer by sluicing. When placer mining by hand labor has been exhausted, it is probable that the Klondike will, for many years, yield profitable results from mining by hydraulic machinery.

**POPULATION AND TOWNS.** News of the great strikes in the Klondike quickly spread, and miners at once flocked in from other districts, including about 800 or 900 from Circle City, Alaska, till by April 1, 1897, the population in the Klondike numbered about 1,500; and during the season of 1897 about 4,000 more came in. During the season of 1898, from April to September, about 40,000 entered the district, many of whom, however, left before or at the end of the season. Dawson, the chief town of the district, is situated on the east bank of the Yukon, just north of the mouth of the Klondike river. It was located as a town site about Sept. 1, 1896, by Joseph Ladue (the author of *Klondike Facts*), of the firm of Harper & Ladue, owners of a saw-mill at Sixty Mile; and within six months from that date about 500 log-houses had been built, including residences, stores, hotels, restaurants, and saloons. In August, 1897, the population was about 3,000, but by October 1 the number had been reduced to about 2,000. In September, 1898, the population had grown to about 20,000. At that date the town had 4 churches, 2 banks, a saw-mill, an opera house, a variety theatre and dance hall called the Pavilion, and 2 newspaper offices, from one of which the *Yukon Midnight Sun*, the first newspaper in Dawson, made its first appearance on June 11, 1898, and from the other of which the *Klondike Nugget* appeared five days later; the price of each paper being 50 cents a copy. The main street has a solid line of four or five blocks of substantial structures, many of which cost from \$20,000 to \$30,000 each. Dawson is the headquarters of the Canadian Northwest mounted police. Land on the main street, in the central part of the town, sells for from \$500 to \$1,000 a foot frontage; residence lots of 50x60 feet fetch from \$100 to \$2,000 each, according to location. A business lot on the second street from the river sold in May, 1898, for \$10,000. A log cabin rents for \$200 a month. In the summer of 1897, another town, called The Forks, sprang up on the north side of Bonanza Creek,

opposite the mouth of the Eldorado. Fort Cudahy, Fort Constantine, and Forty Mile are other towns or posts, all being situated on the Yukon, at the mouth of Forty Mile Creek, 53 miles below Dawson. On the route from Skagway, at the head of Lynn Canal, to Dawson, there are villages or posts, with Canadian post offices, having a fortnightly service, at Bennett, Tagish House, White Horse Rapids, Lebarge, Hootalinqua, Big Salmon, Little Salmon, and Sixty Mile.

On April 26, 1899, Dawson City was almost entirely destroyed by fire. It has since been in some measure rebuilt. The administration of the Yukon Territory, which dates from July, 1898, when the Canadian government organized it and appointed William Ogilvie as first commissioner, is still primitive and inefficient. This will no doubt henceforth be improved as the Ottawa government obtains a larger return from royalties and miners' certificates. The amount it received for the year ending June 30, 1899, in the way of revenues from the district, was in the neighborhood of one million dollars, exclusive of customs levies. This amount it is claimed to have disbursed in administration expenditure, including the expenses in maintaining the militia force (the Northwest Mounted Police), in disbursements on the postal and customs service, and on public works. The value of the gold yield in the Yukon district for the year 1898 was, in round figures, \$10,000,000; in 1899 the yield was \$16,000,000. The local gold commissioner representing the Canadian government is (1900) E. C. Senkler. Geological experts, reporting for government on the probable productive area of the Yukon gold fields, state that the Klondike gold district, as at present known, covers an area of 1,000 square miles. This area, it is explained, refers to the district traversed by the gold-bearing creeks, and not to the actual area of pay gravels. At present the bulk of the gold yield is derived from the Eldorado and Bonanza creeks.

For particulars as to climate, routes, outfit, postal service, etc., see ALASKA, *ante*, pp. 111b-111d.

**KLOPP, ONNO**, a German historian; born in Leer, Hanover, Oct. 9, 1822; taught in the Osnabrück Gymnasium in 1845-58. His historical works attracted the attention of King George V of Hanover, who attached him to his person in 1865. When the blind sovereign was driven out of his kingdom after the defeat of his troops by the Prussians at Langensalza in 1866, Klopp followed him into exile. He joined the Roman Catholic Church in 1874, and settled near Vienna, giving his time to historical researches and writings. He wrote *Geschichte Ostfriesland* (3 vols., 1854-58); *König Friedrich II von Preussen und die Deutsche Nation* (1867); *Tilly im 30 jährigen Krieg* (1861); *Der Fall des Hauses Stuart* (14 vols., 1875-87); *König Georg V* (1878); *The Thirty Years' War to the Death of Gustavus Adolphus* (1891).

**KLOPSCH, LOUIS, M. A.**, Ph. D., journalist, and proprietor of the *Christian Herald*, New York, was born in Germany, March 26, 1852. His father, a physician, who had actively participated in the revolution of 1848, came in 1854 with his family to the United States and settled in New York city. Here Klopsch attended the public schools. In 1890, after



a journalistic experience of twenty years, he purchased the *Christian Herald* and engaged Rev. T. DeWitt Talmage as its editor. Introducing secular enterprise into religious journalism, he achieved a success unprecedented in that particular field. Since 1893, with the aid of his paper, he has raised and distributed in international charities the sum of one million dollars. In recognition of his relief operations in connection with the Russian famine of 1892, he was received by the present Tsar of Russia and royally entertained by the municipalities of St. Petersburg and Moscow. In 1898 the English and Indian governments officially united in special thanks for his services in behalf of famine-stricken India, when he sent a cargo of corn by the relief steamship *Everett* and money aggregating over \$400,000. In the same year President McKinley appointed him one of the three United States commissioners charged with the relief of the reconcentrados in Cuba. His work in Armenia, Constantinople, and elsewhere has also contributed to make him notable as an international philanthropist.

KLUAHNE, a lake in Yukon district, Canada, 50 miles long by about 6 miles wide; its outlet, the Klaant river, flows into the White River.

KNAPP, JACOB HERMANN, German ophthalmologist; born in Dauborn, Prussia, March 17, 1832; educated in Germany, France, and England; graduated in medicine at Giessen, in Hesse-Darmstadt, in 1854; professor of ophthalmology at the University of Heidelberg, 1860-68. In 1868 he settled in New York, and in 1869 founded the New York Ophthalmic and Aural Institute, of which he has since been surgeon. In 1869, also, he founded the *Archives of Ophthalmology and Otolaryngology*, a monthly. Since then he has filled various important professional positions in New York. He has written *Intraocular Tumors* (1868); *Cocaine and Its Use in Ophthalmic and General Surgery* (1885); *Fermentation, Putrefaction, and Suppuration* (1886); *Cataract Extraction without Iridectomy* (1887); *One Thousand Successive Cases of Cataract Extraction without Iridectomy* (1887).

KNAPP, SAMUEL LORENZO, an American author; born in Newburyport, Mass., Jan. 19, 1783. He wrote *Travels in North America, by Ali Bey* (1818); *Biographical Sketches of Eminent Lawyers, Statesmen, and Men of Letters* (1821); *Memoirs of General Lafayette* (1824); *The Genius of Freemasonry* (1828); *Discourse on the Life and Character of DeWitt Clinton* (1828); *Lectures on American Literature* (1829); *American Biography* (1833); *History of the United States* (1834), etc. Died in Hopkinton, Mass., July 8, 1838.

KNAUS, LUDWIG, a German genre painter; born at Wiesbaden, Oct. 10, 1829; entered the Düsseldorf School of the Fine Arts, where he studied under Sohn and Schadow; went to Paris, and, except one year spent in Italy, lived there for eight years, perfecting himself in the technical part of his art by close study of modern French masters. His *Promenade* was honored with a place in the Luxembourg in 1855. His next important pictures were *The Golden Wedding* (1858) and *The Christening* (1859). In 1860 he returned to Wiesbaden, but in 1861 went to Berlin, and in 1866 to Düsseldorf, whence, in 1874, he returned to Berlin, to fill an important post in the Academy.

His *Children's Festival* (1869) is in the National Gallery, Berlin. Others of his works are *Funeral in a Hessian Village* (1871); *His Excellency Traveling*; *The Village Musician*; *The Inn* (1876); *The Refractory Model* (1877); *Solomon's Wisdom* (1878); and *A Peep Behind the Scenes* (1880); the last of which created a great deal of interest in Düsseldorf. Several of his best works are owned in America, among them *Priest and Poacher*. Other good examples were sold at high prices at the Wolfe and Latham sales in New York. His *Holy Family, Peace*, and *None but the Cats* are in the Metropolitan Museum, New York; and *Mud Pies* (1873) is in the Walters Gallery, Baltimore.

KNEELAND, SAMUEL, naturalist and educator; born in Boston, Mass., Aug. 1, 1821. During the Civil War he was a surgeon in the Union army, and in 1866 was mustered out with the brevet rank of lieutenant-colonel. In 1867-78 he was instructor or professor in the Massachusetts Institute of Technology, and later devoted himself to travel, literature, and lecturing. He wrote *Science and Mechanism* (1854); *The Wonders of the Yosemite Valley and of California* (1871); *An American in Iceland* (1876); a work on the Philippines entitled *The Land of Hemp and Sugar*; and *Volcanoes and Earthquakes* (1888). Died in 1888.

KNIAZHININ, IAKOV BORISOVICH, dramatist; born in Pskov, Russia, Oct. 3, 1743. Though influenced by, if not adapted from, the tragedies of Voltaire, Corneille, and Racine, his plays met with great success in Russia, especially his patriotic tragedies *Roslav* (1784) and *Vadim Novgorodskii* (1789). The latter was published in 1793 after his death, but on account of its liberal utterances brought its publishers much trouble. His best comedies are *The Boaster* and *The Queer One*. Died Jan. 14, 1791.

KNIGHT, DANIEL RIDGEWAY, an American painter; born in Philadelphia about 1845. In 1872 he went to Paris and studied at the École des Beaux Arts and under Gleyre, and in 1876 under Meissonier, and has since lived almost entirely in France. To the Paris Salon he sent *The Fugitives* (1873); *French Washerwomen* (1875); and *Harvesters' Repast* (1876); and to the National Academy, New York, *The Veteran* (1870); *Othello in the House of Brabantio* (1871); *The Antiquary*, *The Old Beau*, and *Dividing the Profits* (1873); *Strolling in the Garden* (1874); *Market Place at Poissy* and *Harvest Scene* (1877); and *Pot au Feu* (1878). Other works are *The Vintage in France* (1877); *After Breakfast* (1878); *A Halt* (1880). *Dewerless* (1883); *Un Deuil* (1883); *Chatterboxes* (1885); and *In October* (1887). His studio is now (1899) in Poissy.

KNIGHT, EDWARD HENRY, Anglo-American mechanic; born in London, June 1, 1824. In 1845 he came to the United States, and after 1863 was in the Patent Office, Washington, where, in 1871, he founded the *Official Gazette of the United States Patent Office*. He was juror at the Philadelphia (1876), Paris (1878), and Atlanta (1881) exhibitions; and in 1878 was U. S. commissioner at Paris, where he was made chevalier of the Legion of Honor. He published *Library of Poetry and Song* (1870; rev. ed., 1876); and *Practical Dictionary of Mechanics* (4 vols., 1877-84). Died in Bellefontaine, Ohio, Jan. 22, 1883. His brain weighed 64 ounces, one of the heaviest on record.

KNIGHT, RICHARD PAYNE, an English antiquarian and author; born in Herefordshire in 1750. From an early age he took great interest in the study of ancient art and literature, and on inheriting his grandfather's great wealth he devoted himself to researches and purchases in his favorite field of work. In his extensive travels he amassed a vast collection of ancient coins, bronzes, statuary, and other objects relating to the Greek and Roman religions. His *Account of the Remains of the Worship of Priapus* (1786; New York, 1874) caused some scandal, but was finally accepted as an authority on the topic. He was an M. P. and a trustee of the British Museum, to which he bequeathed his magnificent collection, valued at £50,000. He wrote several pamphlets tending to prove that Homer's poems are the works of one man; also *An Analytical Inquiry into the Principles of Taste* (1805). Died in London, April 24, 1824.

KNIGHT, THOMAS ANDREW, an English biologist and horticulturist, brother of the preceding; born at Wormsley Grange, Herefordshire, Oct. 10, 1758. He contributed greatly to the progress of these branches of science in England. Elected a fellow of the Royal Society, in some of his papers inserted in the *Transactions* he almost reached Darwin's radical conclusions. He published several monographs on fruit-culture, and after his death his remarkable *Physiological and Horticultural Papers* were collected in book-form. He died in London, May 11, 1838.

KNIGHT, WILLIAM ANGUS, a Scotch philosopher and educator; born at Mordington, Scotland, Feb. 22, 1836; graduated from the University of Edinburgh; appointed professor of philosophy in the University of St. Andrews in 1876. His teachings exerted a strong and wholesome influence upon his pupils. He has published *Poems from the Dawn of English Literature to 1609* (1863); *Colloquia Peripatetica* (5th ed. 1870); *Philosophical Classics for English Readers* (15 vols., 1880-90); *The Philosophy of the Beautiful* (2 vols., 1891-93); *University Extension Manuals* (18 vols., 1891-94); *Aspects of Theism* (1894); *The Christian Ethics* (1894); *Works of William Wordsworth and Dorothy Wordsworth* (12 vols., 1890-97); *Museo Vaticanis* (1897).

KNIGHTS AND LADIES OF HONOR. See BENEFIT SOCIETIES, in these Supplements.

KNIGHTS OF HONOR. See BENEFIT SOCIETIES, in these Supplements.

KNIGHTS OF LABOR. See LABOR ORGANIZATIONS, in these Supplements.

KNIGHTS OF LABOR, INDEPENDENT ORDER OF. See LABOR ORGANIZATIONS, in these Supplements.

KNIGHTS OF PYTHIAS. See BENEFIT SOCIETIES, in these Supplements.

KNIGHTS OF THE MACCABEES. See BENEFIT SOCIETIES, in these Supplements.

KNIGHTSTOWN, a village of Henry Co., Ind., on Blue River, 34 miles E. of Indianapolis; has an academy, a Soldiers' and Sailors' Orphans' Home, abundant water power, natural gas, electric lights, machine-shops, mills, foundries, and tile, lumber, pump, and paper factories. Population 1900, 1,042.

KNIGHTSVILLE, a village of Clay Co., Ind., 2 miles E. of Brazil, in the centre of the block-coal

region of the state; is a shipping-point for freight between Indianapolis and St. Louis; and has extensive blast-furnaces and rolling-mills, and the works of the Indiana Coal and Iron Co. Population 1890, 1,148; 1900, 1,171.

KNIPPERDOLLING, BERNHARD, a German religious fanatic; one of the leaders of the Anabaptist sect that ruled over Münster, Westphalia, in 1532-35. He was burgomaster of the city, but after its capture by Count Waldeck, June 24, 1535, was, with John of Leyden, put to death with horrible tortures, Jan. 23, 1536. See also ANABAPTISTS, Vol. I, p. 786.

KNORRING, ERIK OSKAR VON, traveler and writer; born in Sweden in 1822; when quite young entered upon a successful literary career; after 1884 editor and publisher of the periodical *Läsning i Hemmet* (*Home Reading*); published a number of novels, tales, and sketches; also *Reminiscences of the Danish Campaign of 1849, by a Swedish Volunteer* (1864); and *Two Months in Egypt* (1873).

KNOT OR GRAYBACK. See KNOT, Vol. XIV, p. 129; SANDPIPER, Vol. XXI, p. 260.

KNOTT, JAMES PROCTOR, an American statesman; born in Lebanon, Ky., Aug. 29, 1830; in 1846 began to study law; elected to the state legislature in 1858, and in 1859 appointed, and in 1860 elected, state attorney-general. In 1861, for refusing to take an ironclad Union oath, he was imprisoned and disbarred, and his office was declared vacant. In 1866 he was elected to Congress, and obtained his seat with some difficulty; was re-elected in 1868 (during which Congress he made his famous "Duluth" speech), and again in 1874, and served from 1875 to March, 1883, in which year he was elected governor of Kentucky. He was afterward an unsuccessful candidate for the United States Senate.

KNOWLEDGE. See METAPHYSIC, Vol. XVI, pp. 82-98; COMTE, Vol. VI, pp. 234-36; LOCKE, Vol. XIV, pp. 760-62.

KNOWLES, JAMES, an architect and litterateur; born in England in 1831; educated as an architect at University College, London, in his father's office, and in Italy; is a fellow of the Royal Institute of British Architects. Among his best artistic efforts are Aldworth (Tennyson's Surrey residence); Kensington House, London; Albert Mansions, in Victoria street; the Public Gardens and Fountains, Leicester; and several London churches. In 1870-77 he edited *The Contemporary Review*, which was made the organ of the Metaphysical Society, which he had originated in 1860, with forty members chosen from leading British speculative thinkers. In 1877 he founded *The Nineteenth Century*. He compiled (from Sir Thomas Mallory) *The Story of King Arthur* (1860).

KNOW-NOTHINGS. See *American Party* under UNITED STATES, Vol. XXIII, p. 770.

KNOX, HENRY, an American soldier and patriot; born in Boston, Mass., July 25, 1750. When 18 years of age evinced a love of military affairs by joining an independent company of grenadiers, of which he was chosen commander. In 1770 he became a bookseller, but his patriotic and military ardor soon led him to espouse the cause of the colonies by joining the army investing Boston. During the winter of 1775-76 he distinguished himself by the success-

ful issue of a hazardous project, by which fifty-five pieces of ordnance and a large quantity of ammunition were transferred from Lake George and the forts near the Canadian frontier to Washington's army, his services being rewarded by Congress with the commission of brigadier-general of artillery. He took an active part in the battles of Bunker Hill, Trenton, Brandywine, Germantown and Monmouth, and during the siege of Yorktown rendered efficient service, enjoying the distinction of Washington's special confidence and esteem. In

1775 he was appointed Secretary of War, being reappointed under Washington's first administration, and executing the duties of the office with remarkable tact and energy. In 1794 he withdrew from official life, and retired, poor, but highly honored, to a homestead on the Penobscot, in Maine. His services to his country, however, had been too eminent to permit long obscurity, and he was repeatedly chosen to the Maine legislature and to the council of state. He died at Thomaston, Maine, Oct. 25, 1806.—His wife, Lucy, daughter of the secretary of Massachusetts province, was remarkable for her personal beauty and amiable character, no less than for her intellectual power. She became an intimate in Washington's household, having followed her husband's fortunes in the field, and endearing herself to the soldiery by her courage during the trying scenes at Valley Forge. In matters of ceremony and official courtesy her judgment was in constant demand by Mrs. Washington, and even in affairs of state her counsel was not infrequently sought by the commander-in-chief.

KNOX, JOHN JAY, an American financier; born in Knoxboro, Oneida County, New York, March 19, 1828; was graduated from Hamilton College (1849), and immediately entered the banking business, his father, John J., having been a noted New York state banker, a general in the militia, and for thirty years chairman of the board of trustees of Hamilton College. He did business as a private banker at St. Paul, Minnesota, from 1857 to 1862.

A pamphlet on national banks, written in the latter year, attracted the attention of Secretary Chase, who appointed him chief of the mint and coinage correspondence of the Treasury (1866); deputy comptroller of currency (1867); comptroller of the currency (1872). His report on the mint service was one of the efficient causes of the Coinage Act of 1873.

He assisted in the work of the resumption of specie payment (1879); abandoned the comptrollership for the presidency of the National Bank of the Republic, New York City (1884); wrote *A History of the Various Issues of Paper Money by the United States Government* (1884; rev. ed. 1887). He died in New York City, Feb. 9, 1892.

KNOX, THOMAS WALLACE, an American traveler, journalist, and author; born in Pembroke, New Hampshire, June 26, 1835. After teaching school for a few months, he visited the gold-fields of Colorado in 1860, but enlisted as soon as the Civil War broke out. After two campaigns he retired with a lieutenant-colonel's brevet, to join the field-staff of a New York daily. Later, he crossed Siberia with a telegraph-laying expedition, making 3,600 miles on sledges and 1,500 miles on wheels, and publishing his impressions under the title of *Overland Through Asia*. He wrote a number of books for boys, which proved very successful, being mainly based upon his own traveling experiences. He wrote, also, a *Life of Henry Ward Beecher*; *Lives of Blaine and Logan*; *Decisive Battles Since Waterloo*; and a *History of the Republican Party*; etc. He died in New York City, Jan. 6, 1896.

KNOX COLLEGE, a non-sectarian, co-educational institution, situated at Galesburg, Illinois; founded in 1837; organized in 1841; first class graduated in 1846. From then until 1895 1,135 graduates received their diplomas from the institution. In 1895 there were 31 professors and instructors, 688 students, and 8,000 volumes in the college library. The productive endowments amounted to \$175,000, the total revenue to \$13,000 per annum, and the value of buildings and equipment was set down at \$325,000.

KNOX COLLEGE, a theological training institution located at Toronto, Ontario, in connection with the Canadian Presbyterian Church. The present site of the college, which was founded in 1846, is a commanding position on Spadina Avenue, in the Ontario capital, on which a handsome edifice was erected in 1875. The college has numerous lecture-rooms, and the residence has accommodation for 75 students. There is also a fine library and convocation hall. The theological course extends over three sessions, and there is at the disposal of the authorities a number of valuable prizes and scholarships. The college, which is affiliated with Toronto University, is governed by a board of management, appointed annually by the General Assembly of the church. The senate consists of the principal, the professors and lecturers of the college, and a number of gentlemen, clerical and lay, appointed by the General Assembly.

KNOXVILLE, a city of Knox County, north-western central Illinois, 50 miles W.N.W. of Peoria, on the Chicago, Burlington and Quincy railroad. It is the seat of the Illinois Protestant Episcopal diocesan school for girls, and of a Swedish college. Coal-mining and manufacturing are carried on, there are eight paving-brick yards, and carriages, plows, wagons, flour, and woolen goods are produced. Population 1890, 1,728; 1900, 1,857.

KNOXVILLE, a city and the capital of Marion



GENERAL HENRY KNOX.



JOHN J. KNOX.

County, Iowa, situated 40 miles S.E. of Des Moines, on the Chicago, Burlington and Quincy and the Chicago, Rock Island and Pacific railroads. It is in an agricultural and coal-mining region, and good building-stone and timber are also found here. It has an iron foundry, steam-mills, washer and woolen factories. It is the seat of the Iowa Home for Adult Blind, and is supplied with electric lights and city water. Population 1900, 3,131.

KNOXVILLE, a city of Tennessee, the capital of Knox County. It lies on the north bank of Holston River, at the head of steam-navigation, and on the Knoxville, Cumberland Gap and Louisville, the Knoxville and Augusta, the Marietta and North Georgia and the Southern railroads. The leading manufactures are machinery, car-wheels, nails, flour, cotton and woolen goods, leather, furniture, soap, stoves, lumber and wooden-ware. Knoxville is the seat of the University of Tennessee and the State Agricultural College; also of the Tennessee School for Deaf Mutes, the East Tennessee Asylum for the Insane and the Austin Industrial School for Colored Pupils. It was occupied during the Civil War by Burnside, with a Federal force of 12,000 men, in November, 1863. He was besieged and assaulted by Longstreet, who had pursued him hither, without success, on the 17th and 29th of the month, when the Confederates lost heavily. The siege, however, continued, and Sherman was sent to Burnside's assistance, but he was detained by the battle of Chattanooga and did not arrive till December 4th. A short battle ensued, Longstreet was compelled to retire and raised the siege. Population 1890, 22,535; 1900, 32,637. See also KNOXVILLE, Vol. XIV, p. 134.

KNYPHAUSEN, BARON WILLIAM VON, a German soldier; born in Lützberg, Germany, Nov. 4, 1716. He entered the Prussian army in 1734, and became a general officer in the army of Frederick the Great. In 1776 he fought against the Americans as second in command of the corps of Hessians hired by England. He took part in the battles of Long Island, White Plains, Fort Mifflin, Brandywine and Monmouth. While in command at New York he made raids into New Jersey and New England, sacking the village of Connecticut Farms and burning Springfield. He was finally placed in full command of the Hessians, and occupied the city of New York in 1780. He returned to Europe in 1782, having lost an eye and gained little military reputation. The remainder of his life was passed as governor of the Castle of Cassel, Hesse. He died in Cassel, Dec. 7, 1800.

KOALA, COALA, AUSTRALIAN BEAR, NATIVE SLOTH (*Phascolarctos cinereus*), a marsupial found only in eastern Australia, resembling the *Phalangeridae* in general character, but having much larger molar teeth, and the toes of the fore feet disposed in two opposite groups—a peculiarity of structure unique among quadrupeds. The tail is quite rudimentary, and the shape of the animal not unlike that of a bear. The female carries her young on her back for some time after they leave her pouch.

KOBE, a foreign settlement, suburb of HIOGO; q.v., Vol. XI, p. 851.

KOBELL, FRANZ VON, a German mineralogist

and poet; born at Munich, July 19, 1803. In 1834 he became professor of mineralogy at the University of Munich, where he had been assistant professor for eight years, and from 1850 to 1860 he wrote his *Characteristics of Minerals*; he was intensely fond of open-air life, and mingled a great deal with the peasants and foresters. He published *Hochdeutsche Gedichte*, a book of poems. Many of his dialect poems were widely circulated in Germany. His work *Die Urzeit der Erde* (*The Primitive Times of the Earth*) blends erudition with an intense poetic feeling. He died in Munich, Nov. 11, 1882.

KOBO-DAISHI OR KUKAI, priest. See JAPAN, Vol. XIII, p. 581.

KOBOLD, in German fairy-tales, a kind of elf, described as a little old man or woman, oddly dressed in miner's clothes, and fond of hoarding precious metals and gems. They were said to be friendly to mankind, generally choosing some particular habitation, in which they endeavored to render all kinds of services without being discovered.

KOCH, KARL HEINRICH EMMANUEL, a German naturalist; born at Weimar, June 6, 1809. Studied at the universities of Würzburg and Jena, in 1836 undertook a scientific journey to southern Russia; in 1843-44 visited Armenia, Kurdistan, Transcaucasia and the Crimea, where he collected materials for books entitled *Wanderings in the East* (1846-47) and *The Crimea and Odessa* (1853). He published, also, an excellent map of the Caucasian Isthmus and Armenia. In 1836 he was appointed extraordinary professor of Botany at Jena, and in 1848 at Berlin. His chief work is his *Dendrologie* (1869-72). He died in Berlin, May 27, 1879.

KOCH, ROBERT, a German bacteriologist; born at Klausthal, Hanover, Dec. 11, 1843; received his M.D. degree from Göttingen; practiced as a physician in a village near Hanover, and later in Rackwitz and Wollstein. While there his name came before the public in 1880, as an expert in connection with the famous Speichert poisoning case. The conviction of the prisoner was entirely owing to the medical testimony of Dr. Koch, which attracted such attention that he was summoned



DR. KOCH.

to Berlin and appointed a member of the Sanitary Commission and a professor of the School of Medicine. In 1882 he made the discovery that tuberculous diseases are due to the existence of bacilli, and announced a specific germ, which he called the bacillus tuberculosis. Thenceforth he devoted his entire efforts to finding some rival microbe or chemical antidote powerful enough to neutralize the operations of the tuberculous bacilli. In 1883 he was placed at the head of the medical commission dispatched by the German government to Egypt and India for the purpose of making researches into the causes and prevention of cholera. While at Calcutta he suc-

ceeded in discovering, in the water of a cistern, the comma-like microbe of cholera Asiatica, for which, until now, no one has succeeded in discovering an antidote. On his return to Germany he was rewarded by the government, for his researches, with an honorarium of 100,000 marks, the rank of Privy Councilor and the rectorship of the Imperial Institute of Hygiene.

In September, 1890, Dr. Koch startled the world by the announcement that he had discovered a remedy which would destroy the bacillus tuberculosis and expel it from the human system without injuring the tissues in which the germ resides. After the hopes of the unfortunate victims of tuberculosis had been excited to the point of hysteria, and when thousands of patients were crowding Berlin to test the new substance, it was recognized that the remedy was generally worse than the disease. The procedure was finally abandoned, and Dr. Koch resumed his researches. The matter of his "lymph" is still *sub judice*, as true consumption takes six years to run its course, and by 1897 the injections of lymph made in 1890-91 may prove to have realized absolute cures in slow, chronic cases. His works include *Zur Ätiologie des Milzbrandes* (1876); *Untersuchungen über die Ätiologie der Wundinfektions-Krankheiten* (1878); *Ueber die Milzbrandimpfung* (1882); *Was Wissen und Können Unsere Aerzte?* (1885); and *Weitere Mittheilungen über ein Heilmittel gegen Tuberculose* (1890).

KOEL, a town of India. See ALIGARH, Vol. I, p. 576.

KOEPPEL, WLADIMIR PETER, a Russo-German meteorologist; born in St. Petersburg, Russia, Sept. 25, 1846; educated there, and at Heidelberg and Leipsic, receiving the degree of Ph.D.; assistant in the Central Physical Observatory, St. Petersburg, (1872-73), meteorologist at the Deutsche Seewarte, at Hamburg (1875), and for many years editor of the *Deutsche Meteorologische Zeitschrift*. He made many ascents in free and captive balloons for scientific purposes. He wrote for the *Repertorium für Meteorologie* (1869-74), for *Die Annalen der Hydrographie und Maritimen Meteorologie*, and for *Das Archiv der Seewarte*.

KOH-I-NOOR. See DIAMOND, Vol. VII, p. 166.

KOHLER, ULRICH, a German specialist in Greek epigraphy; born in Germany in 1838; had spent several years in Athens as secretary of the German Archæological Institute, when he published his famous work on Attic inscriptions; appointed professor of Greek history at the Berlin University in 1888.

KOHL-RABI. See AGRICULTURE, Vol. I, p. 370; and HORTICULTURE, Vol. XII, p. 284.

KOHLRAUSCH, FRIEDRICH, a German physicist; born at Rinteln, Germany, in 1840. He was the son of RUDOLF KOHLRAUSCH, a distinguished professor of physics at the Cassel Polytechnicum; studied at Marburg and Erlangen; received his Ph.D. from Göttingen in 1863; after filling instructorships at Göttingen and Frankfort-on-the-Main he was successively professor of physics at Zurich (1870-71), Darmstadt (1871-75) and Würzburg (1877-88). He succeeded Kundt as director of the Strasburg

Physical Laboratory in 1888, and was the author of an excellent *Manual of Physical Laboratory Practice (Leitfaden der Praktischen Physik)* (1879), translated into English, French, Russian and Hungarian. —His brother, WILHELM FRIEDRICH, born at Marburg in 1855, received his Ph.D. from Würzburg; an electrician of reputation, he became successively professor of theoretical physics at Strasburg in 1883 and professor of electricity at the Royal Engineering School at Hanover in 1884.

KOH-SABAP, same as CHANTIBURI. See SIAM, Vol. XXI, p. 852.

KOKOMO, a city and capital of Howard County, northern central Indiana, on the Wild Cat River, 54 miles N. of Indianapolis, and on the Pittsburg, Cincinnati, Chicago and St. Louis, the Toledo, St. Louis and Kansas City and the Lake Erie and Western railroads. It is in an agricultural, stock-raising and lumbering region, and manufactures hubs and spokes, doors, furniture, flour, plate-glass, bits, stoves and ranges, sashes and blinds and woolen goods. It has banks, churches, high schools and several weekly newspapers. Population 1890, 8,261; 1900, 10,609.

KOKO-NOR or KUKU-NOR ("Blue Sea"), a lake of Tsing-Hai province, in the western Chinese Empire, north of Tibet, crossed by lat. 37° N., long. 100° E. It receives the drainage of a large, broad valley, but has no outlet, and its waters, in which fishes abound, are very salt and bitter. Length, 65 miles; breadth, 18 to 40; altitude, 10,700.

KOLA, the most northern town of European Russia. It is situated on the peninsula of Kola, is the capital of Russian Finland, and has a capacious harbor. Population, 770. The peninsula of Kola is a dreary expanse of forests and lakes, but has several ranges of mountains, one of which, the Umbdek Mountains, on the east side of Lake Imandra, rises to 3,300 feet.

KOLA-NUT. See NUT, Vol. XVII, p. 664.

KOLAR, JOSEF JIRI, a Bohemian actor and playwright; born in Prague, Bohemia, Feb. 9, 1812, where he studied philosophy at the university. He made a very successful *début* on the stage in 1837, and soon became the star tragedian of the Bohemian theater, appearing in the chief Shakespearean rôles. He translated or adapted a number of plays by Shakespeare, Schiller, Goethe, and wrote many tragedies: *Monica* (1846); *Zizkova Smrt* (1850); *Magdalena* (1851); *Primator* (1883); *Kralovna Barbara* (1884); *Mistr Geronym* (1886); and comedies: *The Veterans* (1868); *The Ants* (1870); *The Three Pharaohs* (1871). Six volumes of his novels were published between 1854 and 1861.

KOLLAR, JAN, a Bohemian poet; born at Mossove, Hungary, July 29, 1793. In 1819 he became pastor of a Slavic Protestant congregation at Budapest, and in 1849 he was made professor of Slavic archæology in the University of Vienna. He wrote poems in the Czech language, which very powerfully influenced the spirit of his race toward an ultimate unification of all nations of Slav blood. In a treatise, *Ueber die Literarische Wechselseitigkeit Zwischen den Stämmen und Mundarten Sla-*

*vischer Nationen*, he advocates the use of a common Slavic literary language. His best-known poem is a lyric-epic of 643 sonnets, entitled *Slavy Dcera* (*Slava's Daughter*). It had, and has yet, an extraordinary hold upon all Slavs from St. Petersburg to Prague. He died in Vienna, Jan. 29, 1852.

KÖLLIKER, RUDOLPH ALBRECHT VON, a Swiss physiologist and educator; born at Zurich, Switzerland, July 6, 1817; received his Ph.D. from Zurich (1841), and his M.D. from Heidelberg (1842); studied also in Bonn and Berlin. He soon entered upon the microscopic investigations which made him famous. In 1849 he became professor of anatomy at Würzburg, and assisted in founding a medico-physical society there. His works on histology and physiology are acknowledged as standards, and have been translated into most European languages. Among the more important of them are a treatise on microscopic anatomy, including its application to special organs, the results, amounting to a revolution in physiological standards, entitled *Handbuch der Gewebelehre des Menschen* (1852); *Icones Histiologie* (1864); and many monographs on his discoveries and systems of study.

KOLOSHES, same as THLINKEETS. See INDIANS, Vol. XII, p. 826.

KOLTSOV, ALEXEI VASILIVITCH, a Russian poet; born at Voronezh, Russia, Oct. 26, 1809, of humble parentage; at 16, educated only in the rudiments of village-school learning, he tried his hand at writing poetry; a bookseller gave him a book on prosody, and permission to read the works of the poets in his shop. In 1831 he visited Moscow, and in 1835 published his first volume of poems, which made him famous in a year; his visit to St. Petersburg in 1836 was a triumph. His complete poems, 124 in number, are short and rough, but filled with the pathetic melancholy peculiar to the Russian peasant. He has been called the "Burns of Russia." He died Nov. 12, 1842.

KOLTZOFF-MASSALSKY, HELENIA GHIKA, best known as "Princess Dora d'Istria," her literary pseudonym, a Roumanian writer; born in Bucharest, Wallachia, Jan. 22, 1829. She was a member of the famous Ghika family of Wallachia. She began to write at an early age, and by her German translation of the *Iliad* of Homer had attracted attention, when she was married to Prince Koltzoff-Massalsky, and went with him to the Russian court. She left him, however, and, thrown upon her own resources, again began to write. Among the best of her productions are *The Swiss Confederation* (1856); *The Women of the Orient* (1860); *Women, by a Woman* (1866); and a *Pilgrimage to the Tomb of Dante* (1865). She died in Florence, Italy, Nov. 22, 1888.

KONG ISLAND. See SIAM, Vol. XXI, p. 852.

KONG MOUNTAINS. See SOUDAN, Vol. XXII, pp. 277, 278.

KONGO OR CONGO. See AFRICA, in these Supplements.

KONIEH OR KOONIYEH, town. See ICONIUM, Vol. XII, p. 696.

KONIEH OR KOONIYEH, BATTLE OF. See EGYPT, Vol. VII, pp. 765, 766.

KONIG, HEINRICH JOSEPH, a German novelist;

born in Fulda, Germany, March 19, 1790; entered the civil service of Hesse, but devoted much of his time to writing historical novels, which were quite successful and showed much honesty of purpose and careful research; his best effort is undoubtedly his *William Shakespeare* (1850), surrounding the Bard of Avon with the graceful details of a poetical romance. Among his many books may be mentioned *Die Hohe Braut* (1833); *Die Klubbisten in Mainz* (1847); *König Jeromé's Karneval* (1855). He died in Wiesbaden, in 1869.

KÖNIGSTEIN, a town of Saxony, Germany, 17 miles E.S.E. of Dresden, near the left bank of the Elbe. It is noted for its fortress, built on a precipitous rock 450 feet high and 1,180 feet above sea-level—one of the few strongholds of Europe which have never been taken. It has been the place of storage of royal treasures during war. It is used now as a state prison. Population 1890, 4,000.

KONRAD VON WÜRZBURG, a German poet of the thirteenth century; said to have been born at Würzburg, Bavaria; author of several poems of only average merit, among them *Engelhardt*; *Otto mit dem Bart*; *Der Welt Sohn*; *Der Schwanenritter*; *Der Trojanische Krieg* (60,000 verses, unfinished); and *Alexius*. He died in Basel, Switzerland, Aug. 31, 1287.

KONKAN, region of BOMBAY. See Vol. IV, pp. 21, 22.

KOODOO. See ANTELOPE, Vol. II, p. 101.

KOORNHERT, RICHARD, a sixteenth-century Protestant theologian. See ARMINIUS, Vol. II, pp. 551, 552.

KOOTENAY, a river of Kootenay District, British Columbia, rising near lat. 51° 20' N., long. 116° 15' W., and flowing south into Montana, then turning and flowing back through Idaho into British Columbia, where it joins the Columbia River. Its upper course is very irregular and rock-bound; from Bonner's Ferry, Idaho, to Kootenay Lake, it is navigable for any sort of craft, but after it leaves the lake it soon becomes too full of rapids and falls for transportation purposes. The district is rich in silver deposits.

KOOTENAY, KOOTENAI, KITUNAHAU OR COOTENAI INDIANS, an American Indian tribe, counting about one thousand members at the last census (1890), and forming a distinct linguistic stock; they resemble more the Indians east of the Rocky Mountains than those of lower Oregon; they are found nowadays only in Montana and British Columbia. They are peaceable, and have added agriculture to their old pursuits as fishermen and hunters. The Upper Kootenays are nominally Christians; the Lower Kootenays pray and sacrifice to the sun.

KOPPARBERG, a province of central Sweden. See Vol. XXII, pp. 739-741.

KOPTOS, an ancient town of Upper Egypt, on the east bank of the Nile, in lat. 26° N. It was destroyed by Diocletian for having taken part in a war against him. Part of its walls still remain, and it has inscriptions going back to the sixth dynasty. It was of importance as a commercial center, being the western terminus of the caravan route from

Arabia and the East. It had gold-mines, which added to its prosperity.

**KORAIS OR KORAY, ADOMANTIOS**, a Greek patriot and scholar; born in Smyrna, Asia Minor, April 27, 1748. After following a commercial life in Amsterdam, to please his family, he visited Montpellier, France, in 1782, to study medicine and natural history, and in 1788 settled in Paris. His efforts were directed toward resurrecting patriotism in Greece, by means of modern Greek literature, at the same time raising the pride of his compatriots by reminding them of their glorious ancestors. Thus, his editions of Heliodorus, Hippocrates, Xenophon, Plato and Epictetus were the worthy precursors of his *Atacta, ou Mélanges sur la Littérature Grecque Moderne* (1826-35). There is an Athenian edition of his works, collected and published in 1881-87. He died in Paris, April 6, 1833.

**KORA-WOOD OR COCUS-WOOD**, a wood of the Indian tree, *Lepidostachys Roxburghii*. It is imported in logs of six or eight inches in diameter, having the heart-wood of a deep brown color and very hard. It is much used in the manufacture of musical instruments.

**KOREA**. See **COREA**, in these Supplements.

**KOROLENKO, VLADIMIR GALAKTIANOVICH**, a Russian author; born in Zhitomir, Russia, July 15, 1853; when studying in the University of Moscow his liberal ideas caused trouble, and finally he was exiled to eastern Siberia in 1879; returning in 1885, he settled at Nizhni-Novgorod. His writings are of a popular nature, and nearly all works of fiction. Several were translated into English. He wrote *The Vagrant* (1888); *The Blind Musician* and *In Two Moods* (1890-91); *The Master's Dream*; *Sokolnets*; *In Bad Society*; *The Forest Murmurs*.

**KORTING, GUSTAV**, a German philologist, born in Dresden, Saxony, June 25, 1845; was professor of Romance languages and English philology, first at Münster in 1876; then at Kiel in 1893; one of Diez's prominent pupils; founder, with Koschwitz, of the *Zeitschrift für Neufranzösische Sprache und Literatur* (1879); and *Französische Studien* (1880). Among his works of importance are *Geschichte der Literatur Italiens im Zeitalter der Renaissance* (3 vols., 1878-82); *Encyclopädie und Methodologie der Romanischen Philologie* (3 vols., 1884-86); *Grundriss der Geschichte der Englischen Literatur* (1887); *Encyclopädie der Englischen Philologie* (1887); *Lateinisch-Romanisches Wörterbuch* (1891).—His brother, **HEINRICH KARL OTTO**, also a philologist and a professor of the Romance languages at the University of Leipzig; born in Leipzig, March 15, 1859. He wrote *Geschichte des Französischen Romans im XVII Jahrhundert* (2 vols., 1885-87), a work greatly esteemed, even in France. He died in Leipzig, July 19, 1890.

**KOSCHWITZ, EDUARD**, a German philologist; born at Breslau, Oct. 7, 1851; private tutor at Strasburg in 1877; professor of the Romance languages and literature at Greifswald in 1894. Wrote *Les Plus Anciens Monuments de la Langue Française* (1879; 4th ed., 1886); *Grammatik der Neufranzösische Schriftsprache—XVII-XIX Jahrhundert* (1889).

**KOSCIUSKO**, a town and the capital of Attala County, central Mississippi, on Yockanockany Creek,

and on the Illinois Central railroad, 65 miles N.E. of Jackson. Its chief industry is raising cotton, and flour and lumber milling. Population 1900, 2,078.

**KOSSUTH, LOUIS**, a Hungarian patriot; born at Monok, Hungary, April 27, 1806. In 1832 he commenced his political career at the Diet of Presburg as the proxy of a member of the Upper House. Afterward he published a lithographed Liberal paper at Pesth, but the government prohibited its issue. Kossuth was arrested in 1837, tried for high treason and condemned to four years' imprisonment for the stand he took in regard to the illegal arrest of six patriots. He was released



LOUIS KOSSUTH.

after 18 months' confinement because the Liberals in the Diet refused to grant supplies to the government unless he were set free. In 1841 he founded the *Pesté Hirlap*, a newspaper which met with great success, both politically and financially. In 1847, elected to the Diet, he soon became its leader. On the dissolution of the ministry in September, 1848, he became the head of the Committee of National Defense. For the events of the revolutionary war of 1848-49 the reader is referred to the article on **HUNGARY**. In 1849, Kossuth, who had been Dictator of Hungary, fled to Turkey, where he was made a prisoner. In 1851 he was liberated, and sailed to England, and afterward to the United States, where he met with a most enthusiastic reception. In 1852 he returned to England, residing there until the Italian war of 1859 broke out. After that he resided at Turin, devoting his time to scientific researches from that year until his death. Many of his speeches were published in the *Europäische Bibliothek* in 1860-70; in 1880 he published a portion of his memoirs in Hungarian, English, German and French, under the title of *Souvenirs et Ecrits de mon Exil, période de la Guerre d'Italie*. He died in Turin, Italy, March 20, 1894. See Vol. III, p. 137; and Vol. XII, p. 371.

**KOSTOMAROV, NIKOLAI IVANOVICH**. See **RUSSIA**, Vol. XXI, p. 108.

**KOULAN**. See **Ass.** Vol. II, p. 717; and **DZIGGETAI**, in these Supplements.

**KOUMISS**. See **MILK**, Vol. XVI, pp. 305, 306.

**KOVALEVSKÛ OR KOWALEVSKY, EGOR PETROVICH**, a Russian traveler and statesman; born in the government of Kharkov, Russia, in 1811; traveled in Siberia, Montenegro, Upper Egypt (1847), to investigate gold deposits for Viceroy Mehemet Ali Pasha; opened a new caravan road to and from China, through Mongolia, finally concluding a favorable treaty of commerce with China in 1851; appointed chief of the Asiatic Department at the Russian Ministry of Foreign Affairs in 1856; organized several explorations into Khorassan, Kashgar, etc.; wrote several volumes relating to his travels, and a *History of the Crimean War*. He died Oct. 2, 1868.

KOXINGA, a Chinese buccaneer. See CHINA, Vol. V, p. 650.

KOZLOV, IVAN I. See RUSSIA, Vol. XXI, p. 107.

KRAKATOA, a volcano. See SUNDA ISLANDS, Vol. XXII, p. 653.

KRANTZ, JEAN BAPTISTE SÉBASTIEN, a French civil engineer and statesman; born at Arches, France, Jan. 17, 1817; graduated from the Polytechnic School in 1838, and from the School of Roads and Bridges in 1840; was promoted to be Chief Engineer of Roads and Bridges in 1864; assisted in the designing of the buildings of the Paris Exposition in 1867; distinguished himself during the siege of Paris in 1870-71; elected to the National Assembly in 1871; one of the leaders of the Moderate Republicans and a steady opponent of any monarchical restoration; elected a life Senator in 1875; Commissioner-General of the Paris Exposition in 1878, his work was indorsed by all exhibitors; retired as Inspector-General of Roads and Bridges and a grand officer of the Legion of Honor in 1878.—His cousin, JULES FRANÇOIS EMILE, a French admiral; born Dec. 29, 1821; was three times Minister of Marine (1877, 1888 and 1890), and attained the rank of vice-admiral.

KRAPOTKINE, PRINCE. See KROPOTKIN, in these Supplements.

KRASINSKI, ZYGMUNT NAPOLEON, COUNT, a Polish poet. See POLAND, Vol. XIX, p. 304.

KRASNOHORSKA, ELISKA, pseudonym for JINDRISKA PECHORA of HENRIETTA PECH, a Bohemian poetess. See SLAVS, Vol. XXII, p. 152.

KRASNOVODSK, a town and fortress and naval station of Russia on Krasnovodsk Bay; an important starting-point for scientific and military expeditions bound for central Asia. The bay extends from the southeastern shore of the Caspian Sea westward along the fortieth parallel of latitude for seventy miles. It is protected by a long tongue of land, and decreases in width from thirty to five miles as it runs inland.

KRASZEWSKI, JOZEF IGNACY (1812-87), a Polish author. See POLAND, Vol. XIX, p. 305.

KREMER, ALFRED VON, an Austrian scholar and statesman, born in Vienna, Austria, May 13, 1828; studied law as well as the Eastern languages at the university of that city. His knowledge of Arabic and Coptic procured him the appointment of first dragoman to the Austrian consulate in Egypt in 1852; consul at Cairo in 1859, and consul at Galatz in 1862, at Beyrut in 1870; made a councilor of the empire in 1872; commissioner on the Egyptian state debt in 1876; Austrian Minister of Commerce in 1880-81. His published works include *Egypt, the Country and People* (1863); *The Leading Ideas of Islam* (1868); and *The Kulturgeschichte des Orients unter den Kalifen* (1875-77).

KREMLIN, a huge crenelated inclosure in Moscow, comprising a city of public buildings, palaces, churches, gardens, etc. See MOSCOW, Vol. XVI, p. 856.

KRESTOVSKII, VSEVOLOD VLADIMIROVICH, a Russian historian and novelist; born in the government of Kiev, Russia, Feb. 11, 1840; leaving the St.

Petersburg University before graduating, in 1868 he entered the army, and in 1874 wrote a history of his regiment, which caused him to be transferred to the Imperial Guard, and to be made staff historian at the outbreak of the Russo-Prussian War in 1877. As a fiction-writer of secondary merit, but of much imagination and force, he acquired great popularity after the publication of *The Slums of St. Petersburg* (1867), a realistic tale of the great sufferings of the lower classes in the capital. Among his best efforts are *Not the First, not the Last* (1859); *Krovavyy Puf* (1867); and two novels dealing with Russian Jewdom, *Egyptian Darkness* and *Tamara Bendavid*. Several of his stories have been translated into French and German. *The Hetaïra of Jerusalem* is considered his best short poem. His campaign history was published as *Twenty Months in the Active Army* (1879). Died in Warsaw, Feb. 1895.

KRISHNA. See SANSKRIT, Vol. XXI, p. 285; and BRAHMANISM, Vol. IV, pp. 208-210.

KRIZHANICH, YURI, seventeenth-century author. See RUSSIA, Vol. XXI, p. 105.

KROHN, WILLIAM O., an American psychologist; born at Galion, Ohio, in 1868; entered sophomore class, Western College, Toledo, Iowa, in January, 1885; received the degree of A.B. in 1887; went to Yale for post-graduate work in philosophy and psychology; received the degree of Ph.D. from Yale in 1889, and was made professor of philosophy in Western Reserve University, Cleveland, Ohio; resigned in 1891 to visit the psychological laboratories of the German universities; took up special work at Clark University under the direction of G. Stanley Hall in March, 1892, holding a senior fellowship in that institution; was elected to the chair of psychology, University of Illinois, September, 1892. He published *Practical Lessons in Psychology*; editor child-study department of *Intelligence and Interstate School Review*; translated from the German, Preyer's *Directions for Mothers Keeping a Record of a Child's Development*; and is classed among the modern educators who are endeavoring to transfer the basis of pedagogic science from the empirical to the psychological.

KROPOTKIN, PETR ALEXEIEVITCH, PRINCE, a Russian geographer and refugee, was born Dec. 9, 1842, in Moscow; entered the St. Petersburg Military School, and at twenty was commissioned lieutenant; for the sake of adventure obtained service in a Cossack regiment of the Amur, and spent five years in eastern Siberia; at first on the staff of the governor of Transbaikalia and then as attaché for Cossack Affairs to the governor-general of eastern Siberia; made explorations in Amur and northern Manchuria; promoted captain in 1865; returned in 1867 to St. Petersburg and studied mathematics for four years in the University, acting also as secretary to the section on physical geography of the Geographical Society; in 1871 was sent to examine the glaciers of Finland and Sweden; published accounts of his explorations in the *Mémoires* of the Geographical Society, from which he received a gold medal for his Siberian contributions.

In 1872 Prince Kropotkin visited Belgium and became a member of the International Society, ren-



dering himself conspicuous by the ardor of his anarchical opinions. He returned to St. Petersburg, and in 1874 was imprisoned in the castle of St. Peter and St. Paul on account of his activity in promoting nihilist organizations. Transferred to the prison of the military hospital, he escaped in 1876 and fled to England. The next year he took charge of the Jura branch of the International in Switzerland, and founded in Geneva *La Révolte*, a nihilist journal, soon after transferred to Paris. At the instigation of the Russian government he was refused Swiss asylum, for defending the assassination of Czar Alexander II. At Thonon, in Upper Savoy, and in England, where he found refuge, he continued to propagate his revolutionary views. In 1883 he was arrested at Thonon, taken to Lyons, France, convicted of sedition, and sentenced to six years' imprisonment; but in 1886, at the solicitation of Victor Hugo and some English scientists, President Grévy released him, and dismissed him across the border, when he took up his residence in London.

Kropotkin collaborated with his friend Elisée Rêclus on the *Géographie Universelle*, especially contributing the parts relating to Russia. Many of his papers in *La Révolte* found wide circulation in Europe as pamphlets, and he published in English *In Russian and French Prisons* (1887), and in French *À la Recherche du Pain* (1892), in the interests of nihilism. He contributed to this ENCYCLOPEDIA many articles on Russian geography and chief cities, of which the more remarkable for original work are SIBERIA, SYR DARIA, TRANSBAIKALIA and TURKESTAN.

KRÜGER, STEPHANUS JOHANNES PAULUS, a Boer statesman, familiarly known as "Oom Paul" (Uncle



S. J. P. KRÜGER.

Paul), and president of the late So. African Republic. He was born in the Celesberg district of the Cape Colony, a British subject, Oct. 25, 1825. He was of Boer parentage, and at the age of 10 years accompanied his parents and six thousand other Boers in the Great Trek across the Vaal River, inaugurated by the Boers rather than emancipate their slaves. It was a great exodus, a seeking of a promised land among the lions and the natives, neither of whom were pleasantly disposed to the newcomers. But the Boers made room. They shot the lions and served the natives in the same manner, or enslaved them. When Krüger was only 12 years old, he stood behind the wagon-laager on Battle Hill and saw the Zulu crescent surge up the hill almost to the muzzles of the Boer rifles. There was great psalm-singing over the deliverance. At the age of 13 he was present at the great fight on the Blood River, where, after a solemn dedication-service, the Boers fell on the Zulus and slaughtered ten for every Dutchman whom Dingaan had ambushed and massacred.

In 1845 at the age of 16, he had become a field-

cornet, and the next year saw him a full-fledged filibuster, besieging Durban for twenty-six days in the Boers' futile attempt to obtain a sea-gate for their land. He was concerned in the Sand River Convention and in the raid on Livingstone's mission station at Sechelle, and bore no inconsiderable part in the Potchefstroom rebellion of 1857. In 1857 he carried the flag of truce in the Lydenburg rebellion, and on the banks of the Rhenoster River played exactly the same part as Dr. Jameson did in 1896. Then he became a British officer, holding a membership of the executive council until November, 1877, when he was dismissed upon "a serious charge of misrepresentation of money-matters not very creditable to him." Thereafter he became a strong patriot, agitated for independence, and in 1884 made a pilgrimage to Europe to obtain greater freedom for the Transvaal. In 1883 he was elected president of the South African Republic, and reelected in 1888 and 1893, and at once set on foot intrigues with Germany and made repeated attempts to obtain a foothold and outlet upon the coast. He was reelected in 1898.

His position was snug from a financial point of view, a salary of eight thousand pounds and "coffee money" being attached to the office of President, with unlimited possibilities for obtaining pecuniary favors in return for his executive acts. A heavy-built, elderly man, whose movements indicate the great muscular force that has once been his, with a strong, square, sagacious face; with grave, troubled eyes that are usually closed in meditation but which ever and anon suddenly open and fasten upon his visitor with a look of intense penetration; clean-shaven, save for a fringe of gray beard around the iron jaw; with coarse, long, straight gray hair—that is what meets the gaze when the "Staats President" of the South African Republic rises to greet a stranger in the presidential mansion at Pretoria. He dwells in simple, patriarchal fashion in the bosom of a large family, and but for the trooper of the Staats Artillerie mounting guard at the doorway, the official residence of the president could not be distinguished from that of any other well-to-do burgher in the capital of the Transvaal.

President Krüger possesses, with much native ability, many of the better characteristics of the Boers. Inveterate hater of the English, knowing their lust for his land, surrounded by a corrupt ring of capitalists and denying the franchise to all who disagree with him, Paul Krüger is a picturesque anomaly of the nineteenth century. Clever though tricky as a diplomat, his anti-British feelings at length led to his own and his country's undoing. When the Bloemfontein conference, which took place early in June, 1899, came to nothing, and when subsequent negotiations with the British government ended also in failure, Mr. Krüger delivered himself of an ultimatum (Oct. 9th), which, as Great Britain could not discuss, led to war. The Transvaal Boers, joined by their fellow burghers of the Orange Free State, invaded Natal, Cape Colony, and Bechuanaland, and for a time gave the English all they could do to hold their own, even when General Buller arrived with the first

army corps. It was not until the English had met with serious reverses, which brought upon the scene Lord Roberts with large reinforcements, that the tide of battle turned, and the Boer republics were in turn invaded, and the capitals of both Dutch States were captured and occupied. Bloemfontein was entered by the British March 13th; the Vaal was crossed May 25th; Johannesburg was occupied May 31st; and Pretoria fell June 5th, 1900, Mr. Krüger and his burghers escaping to the eastward. With the British flag floating over the capitals of the two Boer republics and the Presidents of both States seeking safety in flight, Boer independence received a crushing blow. The spirits of the Dutch burghers were, however, not yet broken, for the war continued throughout the summer (winter in South Africa), the British columns having much to do ere the Boer power finally collapsed with the flight of Mr. Krüger, early in September, to Lourenço Marques, the Portuguese seaport on Delagoa Bay. Here Mr. Krüger embarked for Holland on a Netherland's warship, and Lord Roberts meanwhile issued a proclamation reincorporating the Transvaal with the other possessions of the British crown. Thus practically ended a long and bitter struggle on the Boers' part for independence, which Mr. Krüger's misguided ambitions and the menacing attitude of his republic towards aliens in the Transvaal had made impossible. Britain, as we write (Oct. 1900), is still confronted, however, with the arduous, and it may be serious, work of pacification throughout the vast areas of the disaffected Dutch colonies. British occupation of the countries will necessarily, for a time, be under military administration; and, though independence is again impossible, a large and early measure of self-government is within practical reach of the Boers. For Mr. Krüger's exile, it is impossible not to feel sympathy, as well as pity for a man who sees the object of his life, for which he has striven so long and so obstinately, slip forever from his grasp. As a prominent journal has remarked: "He has waged a hopeless fight against those great principles of justice and equal dealing and constitutional right which English arms have now asserted in his dominions."

As the old Dopper President and his people could not brook the hunger and thirst for progress which characterized the alien Uitlander in the Transvaal, and from which they had in the past repeatedly ran away, one can readily understand how passionate was their love of isolation and how eagerly they sought to stem the advancing tide of modern civilization as it surged inland over their country. And yet if they could not estop the incoming rush, or with silent dignity submit to be submerged by the new forces which the discovery of gold flung in upon them, they were shrewd enough to exact a price for the unsettling intrusion, and clever at playing the Englishman's game of fighting for the retention of power and dominancy. In choosing to do this, rather than yield an iota of his despotic power, President Krüger recklessly gambled with high stakes and risked everything in

the hazard of war. "Never has England," writes a London journalist, "been defied by a more singular foe than this rugged Boer, who throve on England's military carelessness, traded on her generosity, plotted against her in every chancellery of Europe, and hated her with that most persistent and indiscriminating zeal which a man usually reserves for a personal rather than for a national foe. It is well for her and for South Africa that his stupid despotism is over, and that the cross tyranny which we know as Krügerism can vex the British colonist no more." And yet there is so much that is pathetic in the fall of Mr. Krüger, and so regretful in the lot of his brave burghers, whose republic and that of their neighboring kin he used as dice in diplomacy and war, that no one with a sense of chivalry would wish to dwell either on his own or his country's mistakes. He who created the State and built it must in an especial degree feel deep chagrin at its loss. And yet the issues of the war are but the punishment for his own misrule and many corrupt acts. His country will in the future, we doubt not, be the better off without him. By his flight, he has relieved the British of a great embarrassment; now there is every prospect that the Transvaal will have assured peace, and with peace a new and prosperous era of moral and material development. In his passing from the scene, so also has passed the dream of a Dutch republic from Capetown to the Zambesi. "In the history of South Africa," writes the author of *The Transvaal from Within*, "the figure of the grim old President will loom large and striking—picturesque, as the figure of one who by his character and will made and held his people; magnificent, as one who in the face of the blackest future never wavered from his aim or faltered in his effort; who, with a courage that seemed, and still seems, fatuous, but which may well be called heroic, stood up against the might of the greatest empire in the world. And," continues Mr. Fitzpatrick, "it may be pathetic, too, as one whose limitations were great, one whose training and associations—whose very successes—had narrowed, and embittered and hardened him; as one who, when the greatness of success was his to take and to hold, turned his back on the supreme opportunity, and used his strength and qualities to fight against the spirit of progress, and all that the enlightenment of the age pronounces to be fitting and necessary to good government and a healthy State."

G. M. A.

KRUNG-KRAO OR AYUTHIA. See SIAM, Vol. XXI, p. 852.

KRUPP, ALFRED, a German gun manufacturer; born at Essen, in Westphalia, April 26, 1812. When he was 14 years of age his father, FRIEDRICH, the discoverer of the art of making cast-steel, died, leaving a small forge and shop for the support of his family. In 1848 the shop, employing only two workmen, was taken charge of by Alfred, who rapidly increased its output until he discovered a method of casting steel in large masses, and in 1851 sent to the London Exhibition a block of steel weighing 4,500 pounds, and in

1873 cast steel in one mass weighing 53 tons. Besides rails, tires, wheels, engines, and all kinds



ALFRED KRUPP.

of cast-steel work he also manufactured the large steel guns with which the Germans did such terrible execution when they besieged Paris. These guns are all "built up" by shrinking steel hoops over a central steel tube. There is a single layer of hoops around the tube for guns below nine-inch caliber, while those above this size have two layers of hoops in the after part. Some twenty years ago the Krupp steel guns began to be bought in large numbers by all the European powers; a gun of 135 tons was cast for the Russian Government in 1890, and one of 124 tons was sent over to the Columbian Exposition in 1893. Krupp had to extend his works time and again to fill the pressing orders, so that now over 20,000 workmen are employed in them. They include the foundries and shops at Essen, extending over 1,000 acres; the coal-mines at Essen and Bochum; several iron-mines in Germany and Spain; a series of smelting-furnaces; and some branch works at Nerdweid and Layn. In 1864 Krupp declined the letters of nobility offered him by the King of Prussia. One of the wealthiest men in Germany, he did a great deal for the welfare of employees and their families. But he jealously kept some of his processes secret. A commission appointed some years ago by the United States government to study his system of making large castings for steel guns, tried in vain to get Krupp's permission to enter his works, only workmen being admitted to his great foundries. His son Alfred succeeded him; the concern, however—by far the greatest of its kind in the world—is owned by a corporation. He died July 14, 1887.

KÜCHENMEISTER, GOTLOB FRIEDRICH HEINRICH, a German scientist; born in Buchheim, Saxony, Jan. 22, 1821; received his M.D. from Leipzig, 1846; concentrated his attention upon the study of entozoa and the metamorphoses of intestinal worms, his most important work on the subject *On the Animal and Vegetable Parasites of the Human Body* (1855), having gone through several editions and been translated into English; from 1862 to 1865 he edited the *Zeitschrift des Norddeutschen Chirurgen Vereins*; and in 1874-75 the *Allgemeine Zeitschrift für Epidemiologie*. His main theories are found discussed in PARASITISM, Vol. XVIII, p. 263, and TAPE WORMS, Vol. XXIII, p. 55.

KÜCKEN, FRIEDRICH WILHELM, a German musician; born at Bleckede, Hanover, Nov. 16, 1810. He first studied music at Schwerin under Lürss (his brother-in-law) and Aron, and his songs attracted the attention of the Grand Duke of

Mecklenburg; he pursued his studies, especially counterpoint, with Birnbach, in Berlin, and produced there his first opera, *Die Flucht nach der Schweiz*, which was a success (1839). At Vienna, where he went to study under Sechter (1841), he enjoyed considerable popularity. In 1843 he went to Paris, where he composed the opera *Le Prétendant*, and wrote the music for several of Heine's *Lieder*. From 1851 to 1861 he was chapel-master to the King of Württemberg. Some of his compositions were gathered in *Les Echos de l'Allemagne* and *Friedenshymne*. His lasting reputation is due to his extremely melodious songs, among which *Das Sternelein!* and *O Weine Nicht!* may be considered works of great beauty. He died at Schwerin, in 1882.

KUENEN, ABRAHAM, a Dutch theologian; born at Haarlem, Holland, Sept. 16, 1828; successively student, private tutor, and in 1855 professor of theology at Leyden; a thorough student of the Old Testament. In his book entitled *Historico-critical Investigation of the Origin and Collection of the Books of the Old Covenant* (2d ed. 1885-93), he introduced into the study of the old books much skeptical research, and was severely criticised for doing so. He wrote also *Worship of Israel till the Overthrow of the Jewish State* (1874-75), *Prophets and Prophecy in Israel* (1877); and *National Religions and Universal Religions* (1882). He edited the *Theologisch Tydschrift* from 1867 until his death, which occurred in Leyden, Dec. 10, 1891.

KUFA, a ruined town of Mesopotamia, Asiatic Turkey, on the east coast of Bahri Nedgiff Lake, in lat. 32° N. The Arabic characters called Cufic received their name from this place. It was the seat of Arabic learning for a long time. When, at the end of the eighth century, the residency was removed to Bagdad, the town soon sank into ruins.

KUGLER, FRANZ THEODOR, a German art-critic; born at Stettin, Germany, Jan. 19, 1808; he devoted himself early to the study of the history of art, and spent several years in Italy collecting information for his great work, *Handbook of the History of Painting from the Age of Constantine to the Present Time*, two volumes, published in 1837 and immediately translated into the leading European languages. In 1833 he had been appointed professor in the fine arts at the Berlin University. No less valuable and popular are his *Handbook to the History of Art* (2 vols., 1841-42), and his *Description of the Art Treasures in Berlin and Potsdam*. His novels and his *History of Frederick the Great* are not considered up to the average of his other works. He began (with Lübke, q.v.) a *History of Architecture*. He died in Berlin, March 18, 1858.

KUHN, FRANZ FELIX ADALBERT, a German philologist and educator; born at Königsberg, Prussia, November 10, 1812. After studying philology at the Berlin University, he became successively teacher at the Cologne Gymnasium in 1841 professor in 1856, and rector emeritus of the Berlin University. He may be said to have

inaugurated the new science of comparative mythology, when he endeavored to trace the formative factors of various religious myths through linguistic phenomena. He edited *Zeitschrift für Vergleichende Sprachforschung*, and wrote *Ueber Entwicklungsstufen der Mythenbildung* (1874). He died in Berlin, May 5, 1881.

KÜHNER, RAPHAEL, a German philologist; born in Gotha, Germany, March 22, 1802. After studying philology at Göttingen, he became a teacher in the Lyceum at Hanover, in 1825, and devoted himself chiefly to the Greek language and to Cicero. His *Ausführliche Grammatik der Griechischen Sprache* (3d ed., 1893) arranges the syntax of that language on scientific principles, and marks a new epoch in the teaching of Greek. His *Elementary Greek Grammar* and his *Elementary Grammar of the Latin Language* passed through numerous editions and translations in Germany, England and America, but are now somewhat out of date. In 1879, his son published his father's *Ausführliche Grammatik der Lateinischen Sprache*, in two volumes, a work of deep erudition. He died in Hanover, April 16, 1878.

KU-KLUX-KLAN. A secret political association formed in the southern states of the United States shortly after the termination of the Civil War, for the purpose of preventing freedmen from voting, and nullifying the rules set down in the reconstruction acts. It is supposed that the order was organized in 1867, under various names, "Invisible Empire," "White League," etc. The supreme head was called "The Grand Wizard"; the head of a state, a "Grand Dragon"; the head of a congressional district, a "Grand Titan"; the head of a county, a "Grand Giant"; and, finally, local lodges were ruled by a "Cyclops," the members being called "ghouls." They roamed about at night, wrapped up in dreadful garbs that soon made them the terror of the superstitious negroes. From mere intimidation, the Ku-Klux-Klan advanced to brutality and murder, and practiced their cruelty on the whites who happened to disagree with them, as well as on the negroes. The outrages became so frequent and so fearful that congress appointed a joint committee of investigation in March, 1871, and finally enacted the "force bill" of April 20, 1871, which contained such stringent and effective measures that the Ku-Klux-Klans soon were disbanded for good.

KULJA, a province of the Chinese Empire, central Asia, between 80° and 83° W. long. The soil is fertile, and gold, silver, copper, lead and coal are found. It has a population of about 80,000, scattered mostly along the banks of the Ili. Area, 23,000. Before the Dzurgarion rebellion it had 2,000 inhabitants. The town of Kulja, on the banks of the Ili, had, before the rebellion, a population of 75,000. Now it is but a heap of ruins. See also KULDJA, Vol. XIV, p. 154.

KULLBERG, KARL ANDERS, a Swedish author; born in Sweden, in 1813; graduated in law from the Upsala University, and after sitting on

the bench of the Swedish supreme court, resigned to give his whole time to literature. He wrote poems—*Leopold* (1830) and others—historical novels and studies: *The Cousins* (1846), *Carl Gustav Wrangel* (1843), *Gustavus III and His Court* (1838-39), and a drama, *Svenskarne i Neapel* (1836). He edited *Freja*, a periodical (1836-44). His style is pleasing, and his narratives based on fairly trustworthy facts. He died in 1857.

KULTURKAMPF. See GERMANY, Vol. X, pp. 506, et seq.

KUMAMOTO, a city of southern Japan, situated on the west side of Kiushiu on the Shira River. It is a fortified town, and the capital of the præfecture of Kumamoto. Its fortress, built of enormous stones, withstood all efforts of the Satsuma insurgents to take it. It is the most populous city of this island, the center of the Higo rice trade, and an important military and educational center. It is difficult to reach, however, for the river is only navigable for small steamers, and is malarial. In 1889 it suffered from a severe earthquake. Pop. 1898, 61,463.

KUMQUOT, the native name of *Citrus japonica*, a member of the family *Rutaceæ*, the "golden orange," native to China and Japan. It is a low shrub, rarely of man's height, and bears a delicious fruit, slightly more than an inch in diameter. It has been introduced into Florida.

KUN-DUZ, district, town and river. See AFGHANISTAN, Vol. I, pp. 241, 242.

KUNG-CHIN-WANG, known as PRINCE KUNG, a Chinese statesman; born in 1830. Being Emperor Hin-Fung's brother, he was in 1861, when Hin-Fung died, made one of the regents, as the new emperor, Tung-Che, was then only seven years old. For the suppression of the Taiping rebellion, which occurred while he was a regent, he availed himself largely of the assistance of foreigners. In 1866, and again in 1869, Prince Kung went on special embassies to Europe and America. When, in 1874, he concluded peace with Japan after the Formosan troubles, he was accused of having yielded too much to foreign influence, and was condemned to death. But on the next day an imperial decree restored him to his former high office. In the difficulties with France in 1883-84, ending with the treaty of Tien-tsin, Prince Kung's conduct gave his enemies another opportunity to drive him from power. This prince was noted for his steady endeavors to introduce the ideas, methods and inventions of modern European civilization into China, and would have succeeded in so doing, in spite of many hindrances and a powerful inimical clique, had he understood better the proper methods to be used to reach such radical results. His political adversary, Viceroy Li Hung-Chang, had a clearer comprehension of the ways and means by which China can be gradually brought to adopt modern progress, and his influence through the Empress dowager was all-powerful. When General Grant visited China, Prince Kung entertained him royally. At the close of 1894 he was appointed by the emperor to arrange with

Japan terms of settlement of the war then raging. After Kung's short period of imperial favor, Li Hung-Chang was again called forward, and closed the negotiations with Japan, thus superseding Kung. Died in Peking, May 29, 1898.

**KUNIGUNDE, SAINT**, daughter of Count Siegfried of Luxemburg and wife of Duke Henry of Bavaria, who was crowned king of the Germans in 1002, and emperor in 1014. According to a legend, when accused of infidelity she vindicated her chastity by walking barefoot over hot plowshares and coming out of the ordeal unhurt. After her husband's death, in 1024, she retired into the convent of Kaufungen, near Cassel, which she had founded, and there she died, March 3, 1040. Pope Innocent III canonized her in 1200.

**KURBSKII, ALEXANDER**, a Russian soldier and author. See *RUSSIA*, Vol. XXI, pp. 104, 105.

**KURDISH LANGUAGE**. See *KURDISTAN*, Vol. XIV, pp. 157, 158; and *PERSIA*, Vol. XVIII, p. 655.

**KURIA MURIA ISLANDS**, a group of five rocky islands off the S.E. coast of Arabia, in lat.  $17^{\circ} 3' N.$  and long.  $56^{\circ} E.$  the only inhabited one of which supports from twenty to thirty fishermen. They were ceded to England in 1854. Guano of inferior quality is obtained from them, and they form a landing-place for the Red Sea telegraph-cable.

**KURISCHE-HAFF**, one of the three larger lakes or lagoons of northern Germany. See *GERMANY*, Vol. X, pp. 447-450.

**KURNOOL, KARNUL OR CARNOUL**, the chief town of a district of the same name in the presidency of Madras, southern India, on a rocky spit of land, at the junction of the Hindre and the Tungabhadri rivers, in lat.  $15^{\circ} 50' N.$  and long.  $78^{\circ} 5' E.$  The district itself contains about 7,470 square miles. It has been liable to endemic fever since the construction of the Kurnool Canal, connecting the Tungabhadri at this point with the Pennar. This canal is 189 miles long, and was built for the purposes of irrigation and navigation. Population of district, 956,068; of the town, in 1891, 24,400.

**KURO SIWO OR JAPAN CURRENT**. See *PACIFIC OCEAN*, Vol. XVIII, p. 118.

**KUSATSU**, a village and famous summer resort of central Japan, in Shiga Ken, 25 miles N. by E. of Kyoto. It is the coolest resort in the country, is free from mosquitoes and is especially noted for its hot springs, which range in temperature from  $113^{\circ}$  to  $130^{\circ} F.$ , and are very valuable for rheumatic and similar complaints. They contain sulphur, alum, sulphate of copper, arsenic and borax. Its altitude is 3,800 feet. Population, 5,000.

**KUSI**, a considerable tributary of the Ganges. See *BHAGALPUR*, Vol. III, p. 626.

**KUSKOKWIM**, a river of Alaska, the second in size in the territory, rising on the western side of the Alaskan Mountains, in long.  $148^{\circ} W.$ , and flowing through a very irregular and rock-bound

channel to Kuskokwim Bay, in Bering Sea. It is over 500 miles in length, and is navigable for about 300.

**KÜSTENLAND OR LITTORALE**, a crown land of Austria, consisting of the principality of Goritz and Gradisca, the margravate of Istria, and the town of Trieste with its territory. It lies between the crown land of Carniola on the north-east and the Gulf of Venice on the southwest. The surface is mountainous, and the chief rivers are the Isonzo and the Quieto. The soil is in general fruitful, and wine is made extensively. In the mountainous districts in the north and northeast the breeding of cattle is the chief industry. Commerce is carried on at the various seaports. Area, 3,084 square miles. Population 1890, 695,384.

**KUTUSOFF, MICHAEL LAURIONOVITSCH GOL-ENTISCHÉ**, Prince of Smolensk; a Russian soldier; born in 1745; a cadet in 1761, his brilliant military conduct had made him a major-general in 1784; commanded under Suwaroff in the brilliant capture of Ismail; lieutenant-general in 1791; ambassador to Constantinople in 1796; in the campaign of 1805 against Napoleon, which ended in the latter's victory at Austerlitz, he defeated Marshal Mortier at Dürrenstein; general-in-chief of the Russian army at the time of Napoleon's Moscow campaign, he was beaten at Borodino, but, undaunted, he incessantly renewed his attacks against the French, who were weakened by hunger and cold, and suffered heavy losses at his hands in the battle of Jaroslavatz, Krasnoë and Smolensk; made a prince and a field-marshal as his reward. He died of malignant fever while pursuing the invaders across the frontier in Prussian Silesia, April 28, 1813.

**KUTZTOWN**, a borough of Berks County, southeastern Pennsylvania; on the Philadelphia and Reading railroad, 16 miles N.E. of Reading. It is in an iron and limestone region, has the Keystone State Normal School, and manufactures castings, carriages and shoes. Population 1890, 1,595; 1900, 1,328.

**KWANG-CHOW FOO**, same as *CANTON*, Vol. V, p. 37.

**KWANGSO**, province. See *CHINA*, Vol. V, p. 640.

**KWANG-SU**, "Succession of Glory," the name of the ex-emperor of China; born in 1871; reigned 1875-98; and resigned in 1898. See *CHINA*, Vol. V, pp. 652-53.

**KWANGTUNG**, province. See *CHINA*, Vol. V, p. 639.

**KWEICHOW**, province of *CHINA*, q.v., Vol. V, p. 640.

**KWIKHPAK**, one of the northern delta-arms of the Yukon, Alaska. It is 52 miles long, and is broad and shallow. The Russians gave this name also to the whole river.

**KYLE, JAMES HENDERSON**, United States Senator from South Dakota, a clergyman; born in Centerville, Ohio, in 1854. He graduated from Oberlin (Ohio) College in 1878, and studied theology in the Western Theological Seminary, Allegheny, Pennsylvania. He was for three years a

teacher of mechanical and civil engineering in Pittsburg, Pennsylvania, and studied law; pastor of a church in Salt Lake City, Utah, four years, and an officer of the Utah Commission; a pastor in Ipswich, South Dakota, and Aberdeen, South Dakota; financial agent of the Congregational college at Yankton, South Dakota. In politics he believed in the principles of the Farmers' Alliance, and was elected a state senator in 1890. In 1891 he was elected by the state legislature to the United States Senate as an independent, to succeed Gideon C. Moody, and re-elected in 1897.

KYRIE ELEISON, "Lord have mercy," the

only form of prayer used in the mass of the Roman Catholic Church which has never been translated into Latin out of the Greek of the early church service. In the ordinary of the mass it immediately follows the introit and precedes the *Gloria in Excelsis*. In the Church of England and in the Protestant Episcopal church-service it is embodied in the "lesser litany" or short petition that follows each of the commandments, "Lord have mercy upon us, and incline our hearts to keep this law."

KYUSHU. See KIUSHU, in these Supplements.

## L

## LAALAND—LABOR DAY IN AMERICA

**L**AALAND OR LOLLAND, a Danish island in the Baltic, at the southern entrance to the Great Belt, 36 miles long by 9 to 15 broad. The surface is remarkably flat, and malarial fever is epidemic in its marshy parts, but the soil is exceedingly fruitful. Products: corn, hemp, hops, apples and timber. Forests of beech and oak cover upward of fifty square miles. Area, 1,444 square miles. Population 1890, 65,550. The capital is Maribo, and the largest town Nakskov, with a good harbor and considerable trade. With the exception of this place it is difficult of access on account of surrounding shallows.

**LABAT, JEAN BAPTISTE**, a French missionary and author; born in Paris, in 1663. After teaching for a few years he took charge of a parish in the Island of Martinique, West Indies, from 1694 to 1696. Having joined the Dominicans, he traveled extensively, until his return to Europe in 1705, when he visited Italy and finally settled in Paris. His *Nouveau Voyage aux Îles de l'Amérique* (1724) had several editions, and was translated into Dutch and German. He edited Marchais's *Voyage en Guinée, Îles Voisines et Cayenne*. He died in Paris, Jan. 6, 1738.

**LA BÉDOLLIÈRE, EMILE GIGAULT DE**, a French journalist and historian; born at Amiens, France, May 24, 1812; graduated from the École des Chartes, and the same year published his *Vie Politique du Marquis de LaFayette* (1833). He became a regular contributor to the liberal daily, *Le Siècle*, and founded *Le National* in 1839. Among his works are *Beautés des Victoires et des Conquêtes des Français* (2d ed., 2 vols., 1847); *Histoire des Mœurs et de la Vie Privée des Français* (3 vols., 1847); *Histoire de Paris* (1864); *Histoire Complète de la Guerre d'Allemagne et d'Italie* (1866); *Histoire de la Guerre de 1870-71* (1872). He wrote a few books for children, one of which, in the style of a nursery-rhyme, has been translated and imitated extensively. It is called *Histoire de la Mère Michel et de son Chat* (1851). He died in Paris, April 23, 1883.

**LABEL**. See TRADE-MARKS, Vol. XXIII, p. 499; and FORGERY, Vol. IX, p. 414.

**LABIALIZATION**. See SPEECH-SOUNDS, Vol. XXII, pp. 383, 384.

**LABIALS**, in ancient dialects. See HIEROGLYPHICS, Vol. XI, p. 797.

**LABIATÆ**, a very large family of dicotyledonous plants, mostly natives of temperate climates. They are herbaceous or shrubby, and have four-angled stems and opposite leaves which abound in volatile oil. The flowers are often in cymes or heads, or in whorls, or sometimes solitary. Some are used in medicine. Mint, rosemary, lavender, sage, etc., are examples of this family.

**LABICHE, EUGÈNE MARIN**, a French playwright; born in Paris, May 5, 1815. He was educated at the Collège Bourbon, and studied law, but finally devoted himself entirely to literature. His first dramatic piece was the popular farce, *M. de Coyllin* (1838), which was followed during the next forty years by a series of over a hundred comedies, farces and vaudevilles. He collaborated with Gondinet, Delacour, E. Legouvé, Augier and other dramatists. Labiche was elected to the French Academy in November, 1880. His productions are distinguished by a mastery of stage technique, great drollery of plot and situations, a keen knowledge of human nature, crisp and sparkling dialogue, and a lambent humor that is often caustic but never unkind. A great many of his plays have been adapted for the English and American stage, and have been acted in every civilized language. Among them are *Le Chapeau de Paille d'Italie* (1851); *Le Voyage de M. Perrichon* (1860); *Les Petits Oiseaux* (1862); *L'Homme qui Manque le Coche* (1865); *Doit-on le Dire* (1873). His plays have been collected in a complete edition of ten volumes. He died in Paris, Jan. 23, 1888.

**LABLACHE, LUIGI**, an Italian singer; born in Naples, Dec. 6, 1794. His first engagement as a basso singer was at the San Carlo Theatre, at Naples, in 1812. He afterward sang with much success at Palermo, Milan (1817), when his reputation began to be known all over Europe; at Rome, Turin and Vienna; in the last-named city a medal was struck in his honor. From 1830 to 1857 he sang alternately in Paris and London, making occasional visits to St. Petersburg and Naples. His voice, a deep bass, has rarely been equaled, either in volume or quality; and his acting, particularly in the characters of Figaro, Don Bartolo, Don Pasquale, Leporello, etc., was almost as remarkable. His dignity in the stately parts was equalled by his spontaneous and rich humor in the gay rôles of his repertory. He died in Naples, Jan. 23, 1858.

**LA BOÉTIE, ETIENNE DE**, a French writer and philosopher; born in Sarlat, France, Nov. 1, 1530. He was not 20 years old when he wrote his strong pamphlet entitled *Contre-un*, or a *Discours sur la Servitude Volontaire*, which was published in 1575. He sat in the Parliament of Bordeaux during the last ten years of his life. He was a personal friend of Montaigne, who wrote about him most feelingly. See MONTAIGNE, Vol. XVI, p. 768. He died near Bordeaux, Aug. 18, 1563.

**LABOR DAY IN AMERICA**, a legal holiday for workmen, which first began to be celebrated by a few states in 1887. It falls on the first Monday in September. In Europe, May 1st is usually celebrated as a labor festival, and in some coun-

tries socialistic disturbances have led governments to forbid the usual demonstrations. See also HOLIDAYS, in these Supplements.

LABOR, WOMEN. See INDUSTRIAL CONDITIONS OF WOMEN, in these Supplements.

LABORDE, ALEXANDER LOUIS JOSEPH, COMTE DE, a French soldier and archæologist; born in Paris, Sept. 15, 1774. After serving for some years in the Austrian army, he went to Spain in 1800 to explore that country. He described his experiences in a work entitled *Voyage Pittoresque et Historique en Espagne* (1807-18). He filled several civil offices under Napoleon; was elected a deputy in 1822, and sat in the ranks of the opposition to the Bourbons; took part in the revolution of 1830; was rewarded by being appointed by King Louis-Philippe a brigadier-general of the National Guard, and later prefect of Paris. He wrote a second book on Spain, and also *Les Monuments de la France Classés Chronologiquement* (1815-36). He died in Paris, Oct. 24, 1842.

LABORDE, LEON EMMANUEL SIMON JOSEPH, COMTE DE, a French archæologist, son of the preceding; born in Paris, in 1807. He was educated at Paris and Göttingen. He traveled extensively through the East, and published an account of his visit to Arabia in his *Voyage en Orient*. For some time he held diplomatic positions. In 1846 he published *Les Anciens Monuments de Paris*. He was curator of the middle ages and renaissance collections at the Louvre Museum for some years, and after 1857 director of the archives of the empire. He died in Paris, in 1869.

\*LABOR ORGANIZATIONS, so far as their social and industrial influence is concerned, belong for the United States, to this century. Various clubs, societies and local associations existed at times during the eighteenth century. With the extension of the factory system, labor societies became more frequent, and especially under the reform movements from 1825 to 1850 labor organizations received a new impetus. Since 1825 their growth and progress have been interesting and their development rapid, almost every industry in the country being involved.

A labor organization *per se* is any association of wage-workers or salary-receivers, having for its direct purpose the improvement of the condition of its members through educational work, the increase of compensation and the shortening of hours. Such associations usually take up a great variety of topics belonging to the general, social and economic conditions in which they are placed. The older form of organization came under the general title of "trades union." The underlying principle of individual associations like trades unions is that men who think alike should act together; so a trades union, primarily, is an organization which takes an active and earnest interest in the welfare of its own individual members, and secondarily, of the members of all unions of persons of like occupation, a trades union being composed of the members of a single trade, like the hatters or glass-blowers. Such unions do not, as a rule, undertake to extend their influence to all classes of workers.

\* Copyright, 1897, by The Werner Company.

Among the most noted trades unions now in existence is the International Typographical Union, representing nearly every state and territory, and tracing its origin to 1850. This is the oldest existing American trades union. The hatters were organized in 1854, under the name of the National Trade Association of Hat Finishers of the United States of America. Out of this grew, in 1868, another order, which took the name of the Silk and Fur Hat Finishers' Trade Association of the United States of America. The Iron Molders' Union of North America was founded in 1859. The Brotherhood of Locomotive Engineers dates from 1863, the Cigarmakers' National Union from 1864, the Bricklayers and Masons' International Union from 1865, the Order of Railway Conductors from 1868, the United States Wool Hat Finishers' Association from 1869, the Brotherhood of Locomotive Firemen from the same year, the National Union of Horseshoers of the United States from 1875, the Amalgamated Association of Iron and Steel Workers from 1876, the Granite Cutters' National Union of the United States from 1877, the Brotherhood of Carpenters and Joiners from 1881, the Railroad Brakemen from 1884, the Journeymen Bakers' National Union from 1886. There are many other national trades unions in the country, but those enumerated are the leading ones, and many of them have weekly newspapers of more or less influence.

Besides the national unions named and others of a national character, there are many state and local trades unions, numbering 539 in all, according to the latest information obtainable. These unions exist in nearly every state and territory in the country, the exceptions being Arizona, Delaware, Idaho, Mississippi, Nevada, New Mexico, North Carolina, Oklahoma, South Carolina, South Dakota, Utah, Virginia and Wyoming. The states having the largest number are California, 6; Colorado, 10; Connecticut, 12; Illinois, 46; Indiana, 27; Iowa, 7; Kansas, 10; Kentucky, 9; Louisiana, 6; Maine, 6; Maryland, 6; Massachusetts, 58; Michigan, 51; Minnesota, 9; Missouri, 34; Montana, 6; Nebraska, 9; New Jersey, 8; New York, 58; Ohio, 71; Pennsylvania, 23; Rhode Island, 8; Wisconsin, 27. Each union has its own government as to strikes, dealings with members, and, in fact, all its own regulations.

After some years of experience as to individual organizations there began to grow a strong desire among the unions for some form of federation. This desire was stimulated by the existence of the order of Knights of Labor, organized in Philadelphia in 1869, which will be described later; but prior to this there was an attempt to organize a national union or federation which should comprehend all the various trades unions, national and international, existing in the United States, and the first of such attempts was made in 1866, at Baltimore, when the representatives of the trades unions of New York and Baltimore sent out a call for a national labor congress, which congress met August 20th of the same year, and consisted of one hundred delegates, representing about sixty open and secret organizations. A second convention was held in Chicago the next year (1867). These movements were instituted with



the view of following in the footsteps of the trades-union congresses of England, the local bodies connected with which were not permitted to discuss politics. The necessity arose for having some central body where questions of a political nature, and especially bearing upon national legislation in favor of the working class, could be discussed freely.

The National Labor Union held two conventions in 1868, and it met again in Chicago, in 1869. A meeting was also held in 1870 at Boston, one in 1871 at Philadelphia, and one in 1872 at Columbus, Ohio. The National Labor Union did not meet again, however; yet from it was projected the present American Federation of Labor, which grew more directly out of the industrial congress at Rochester in April, 1874, and a convention, in the same month, of a secret organization known as the Sovereigns of Industry. The Industrial Brotherhood of the United States, a secret order, was represented in this Rochester congress. This latter order had other ideas as to labor organization than the trades unions; thus there was an antagonism in the convention, and the movement ended at Rochester. Other attempts, largely political, were made in 1875 and 1876, and still further attempts at federation were made in the years prior to 1881, when the Federation of Organized Trades and Labor Unions of the United States and Canada was created. This great organization, afterward known as the American Federation of Labor, grew out of a joint call of the Knights of Industry and the Amalgamated Labor Union, the desire being to organize a secret order to supplant, if possible, the growing order of Knights of Labor. The joint call referred to resulted in a convention at Terre Haute, Aug. 2, 1881, but the secret organization sought for was not effected, as the chief element in the convention was trades union in its character and opposed to increasing the number of labor societies then existing; yet another call was made and a second convention held, in Pittsburg, Nov. 19, 1881. This convention represented 262,000 workmen, who sent to it 107 delegates, and in their permanent organization they adopted the name and style of the Federation of Organized Trades and Labor Unions of the United States and Canada.

The American Federation of Labor, as now known, was organized Dec. 8, 1886, at Columbus, Ohio, but it dates its birth from the convention at Pittsburg in November, 1881. At that convention the demand was made for eight hours as a day's work and for the national and state incorporation of trades unions, and the convention favored obligatory education of all children and the prohibition of their employment under the age of 14. It also favored the enactment of uniform apprentice laws, and opposed bitterly all contract convict labor and the truck system for payment of wages. It asked that laws giving to workmen a first lien on property upon which their labor had been expended be enacted; it insisted upon the abrogation of all so-called conspiracy laws; urged the establishment of a national bureau of labor statistics and the prohibition of the importation of foreign labor; opposed government

contracts on public work; and favored the adoption by states of an employers' liability act.

The American Federation of Labor, of course, represents the trades-union element of the United States. It is not a secret order, nor does it claim the individual allegiance of members, for its membership is made up of national and international trades unions or societies represented in it. It is a democratic and representative organization in every sense, being a federation of the leading trades unions of the country. With the exception of the various railroad brotherhoods, the principal labor unions of the country are affiliated with it. It has about 7,000 orders represented in it, and a membership of over 650,000. It undertakes to encourage the formation of local trades and labor unions, and invites the closest federation of all such associations. Its federation is of various orders having dissimilar methods, not only in organization, but in work, and having no common constitution or laws, although the federation has a constitution for the general government of the representative body.

At the convention held in Cleveland, Ohio, Nov. 21, 1882, the American Federation of Labor issued a manifesto opposing political action, on the assumption that it had been organized as a purely industrial body. The manifesto issued at that time is important, and is as follows:

"We favor this federation because it is the most natural and assimilative form of bringing the trades and labor unions together. It preserves the industrial autonomy and distinctive character of each trade and labor union, and, without doing violence to their faith or traditions, blends them all in one harmonious whole—a 'federation of trades and labor unions.' Such a body looks to the organization of the working classes as workers and not as 'soldiers' (in the present depreciatory sense) or politicians. It makes the qualities of a man as a worker the only test of fitness, and sets up no political or religious test of membership. It strives for the unification of all labor, not by straining at an enforced union of diverse thought and widely separated methods; not by prescribing a uniform plan of organization, regardless of their experience or interests; not by antagonizing or destroying existing organizations, but by preserving all that is integral or good in them and by widening their scope so that each, without destroying their individual character, may act together in all that concerns them. The open trades unions, national and international, can and ought to work side by side with the Knights of Labor, and this would be the case were it not for men, either over-zealous or ambitious, who busy themselves in attempting the destruction of existing unions to serve their own whims and mad iconoclasm. This should cease, and each should understand its proper place and work in that sphere; and if they desire to come under one head, or affiliate their affairs, then let all trades and labor societies, secret or public, be represented in the Federation of Trades and Labor Unions."

The headquarters of the American Federation of Labor in 1896 was at Indianapolis, Indiana. The president was Samuel Gompers, and the secretary Augustus McCraith. The *American Federationist* is the official organ of the federation.

The Knights of Labor are organized on a principle widely at variance with that underlying the organization of the trades unions and the American Federation of Labor. The basis of the organization of the Knights of Labor ignores vocation and seeks the unification of all individual or separate interests

in the interests of the whole. This is an exceedingly broad basis, and follows the attempt of the International, organized in London in the autumn of 1864, to associate workmen wherever manufacturing had gained any foothold. The International had some standing in the United States. Its broad foundation had an influence in such future organizations, but its practices were not American, and the attempt of organized labor on its broad basis practically failed. But the second great attempt to utilize the society basis for the basis of labor organization resulted in the Noble Order of Knights of Labor, which was born Thanksgiving day, 1869, in the city of Philadelphia. This order resulted from the efforts of Uriah S. Stephens, who had associated with him six garment-cutters. The garment-cutters of Philadelphia had been organized as a trades union, but had failed in their attempts to increase the rate of wage in their trade. The dissatisfaction growing out of this disappointment resulted in the disbanding of the Garment-Cutters' Union, and Mr. Stephens, who had foreseen such result, prepared the outlines of a plan which should include in an organization all branches of honorable toil. Stephens was a man of great force of character, a thoroughly trained mechanic, a lover of books, and possessed a strong feeling in favor of secret organizations, having been for many years a member of the Masonic order. It was probably through the experience gained in Masonry that he brought into the ritual of the new order many of the features of speculative Masonry, certainly so far as forms and ceremonies were concerned. He also introduced obligations in the nature of oaths, taken upon the Bible with all solemnity. The members were sworn to the strictest secrecy. Even the name of the order was not divulged for a long time, stars being used in the place of the name *Knights of Labor* and in circulars, meetings, conversation, etc., the members referred to the order as "Five Stars." Originally the ritual contained many classical expressions taken from the Greek, showing the scholarly attainments of the founder of the order. At a meeting held Dec. 28, 1869, the name *Knights of Labor* was adopted, and the ritual adopted at the same time contains the following instructions, which have been given to every person ever admitted to the order:

"Labor is noble and holy. To defend it from degradation, to divest it of the evils to body, mind and estate which ignorance and greed have imposed, to rescue the toiler from the grasp of the selfish, is a work worthy of the noblest and best of our race. In all the multifarious branches of trade, capital has its combinations; and whether intended or not, they crush the manly hopes of labor and trample poor humanity in the dust. We mean no conflict with legitimate enterprise, no antagonism to necessary capital; but men, in their haste and greed, blinded by self-interests, overlook the interests of others, and sometimes violate the rights of those they deem helpless. We mean to uphold the dignity of labor, to affirm the nobility of all who earn their bread by the sweat of their brows. We mean to create a healthy public opinion on the subject of labor (the only creator of values), and the justice of its receiving a full, just share of the values or capital it has created. We shall, with all our strength, support laws made to harmonize the interests of labor and capital, and also those laws which tend to lighten the exhaustiveness of toil. To pause in his toil, to devote to his

own interests [*sic*], to gather a knowledge of the world's commerce, to unite, combine and co-operate in the great army of peace and industry, to nourish and cherish, build and develop the temple he lives in, is the highest and noblest duty of man to himself, to his fellow-man and to his Creator."

Under the original formation, physicians could not become members, because professional confidence might force the societies' secrets into unfriendly ears; but this rule was repealed at Detroit, in 1881. Politicians were excluded, but men engaged in political work are not now excluded for the cause originally assigned. Lawyers were and still are excluded from membership. Rum-sellers, being non-productive of articles of use, are not included in those who can become members.

The close secrecy adopted in the beginning of the order prevented its growth, but now the degrees, which were worked somewhat after the Masonic methods, are not known, there being no degrees in the sense of secret organizations. Strict secrecy was abolished at Detroit in 1881, and the name and objects of the order made public.

The Knights of Labor as an organization consist of local assemblies, which may be organized anywhere under proper rules established by the higher assemblies; district assemblies, which are composed of delegates from local assemblies; there may also be state and national trade assemblies; then there is the general assembly, which is composed of representatives chosen by the state, national, trade and district assemblies. Each has its constitution. The general assembly has full and final jurisdiction, and is the highest tribunal of the order. At the meetings of the general assembly, which take place every year, there is usually more or less discussion as to some modification or proposed modification of the constitution. At the time of the abandonment of the secrecy of the workings of the order, which took place, as stated, in 1881, when the oath-bound obligations were abolished and a simple pledge took its place, the Knights of Labor were working upon a declaration of principles adopted at the general assembly, at Reading, Pennsylvania, in January, 1878. Articles have been added from time to time, until the present declaration of principles was adopted. It is too long to be reproduced in full here, but in the main it declares the purpose of the order to be to make industrial moral worth, not wealth, the true standard of individual and national greatness, and to secure to the workers the full enjoyment of the wealth they create. The order demands the establishment of bureaus of labor statistics, the reservation of public lands as a heritage of the people, the incorporation of trades unions and all labor organizations, the prohibition of employment of children under 15 years of age, and of all convict labor, a graduated income tax, and various other important demands along the lines of other labor organizations.

At one time the organization is said to have had nearly one million members. Through various influences the membership has been reduced, although since its foundation about 275 district assemblies, 23 state assemblies and over 1,300 local assemblies have been organized. It is quite impossible to give

the membership at present, but it is supposed to be in the vicinity of 200,000. The order has been extended to Canada, British America, France, Belgium, Great Britain and Australia. It is represented now in every state and territory of the Union, with the exception of Alaska, Arizona and Wyoming. It is exceptionally strong in New York, Massachusetts, and in the Southern and Western states.

The headquarters of the Knights of Labor are at Washington, District of Columbia. James R. Sovereign is the General Master Workman of the General Assembly, and John W. Hayes the general secretary-treasurer. *The Journal of the Knights of Labor* is the official organ of the order.

Following the lines of the Knights of Labor, in some respects, is the American Railway Union, for it has sought to bring into one order a large body of employees. This union was organized in Chicago, June 20, 1893, and I am authorized to say that it is composed of 391 local unions, with a membership, in round numbers, of 120,000. *The Railway Times* is the official paper of the union, published semi-monthly. Eugene V. Debs is the president, the headquarters of the union being at Terre Haute, Indiana.

The American Railway Union differs widely from the Knights of Labor and American Federation of Labor so far as its integral elements are concerned, although it affiliates in some cases with the former. It was created for the protection of members in all matters relating to wages and their rights as employees, and affirms that railway employees are entitled to a voice in fixing wages and in determining the conditions of employment. It is composed of a general union, consisting of representatives of the local unions, which local unions are instituted under the jurisdiction of the general union, and it is the policy of the general union not to declare strikes of its own motion, but to refer such matters to the particular class affected.

The Independent Order of Knights of Labor is a new organization of a national character. Its declaration of principles is identical with that of the Knights of Labor. It was organized at Columbus, Ohio, Feb. 14, 1895. Its constitution is similar to that of the Knights of Labor, except that it eliminates such parts as give general officers great power, and otherwise restricts the possibilities of general officers in directing the affairs of the order. Its friends claim that it has made steady progress, not only in organizing new assemblies, but in reorganizing old ones and in assimilating local and district assemblies of the old order. It takes a progressive stand on social and economic subjects, and seeks to dispel the ignorance that exists in the mind of the workingman, and attempts to cultivate his reasoning powers. Its membership cannot be ascertained. The headquarters of the order are at Tiffin, Ohio. William B. Wilson is the general master workman, his address being Blossburg, Pennsylvania, and Charles R. Martin the general secretary-treasurer, Tiffin, Ohio.

There are very many local orders, societies and associations not connected with any of the large orders described. From the best estimate that I can

make, the total membership of all labor organizations of all kinds reaches at least 1,400,000. They have all been influential in the development of industrial conditions and in securing legislation which relates to labor; in general, it may be said that strikes and matters relating to strikes are referred to local organizations in all the great national orders. None of them countenance riots, violence, intimidations, etc., yet they do not provide for the discipline of members when guilty of these things.

For fuller information relating to labor organizations, details of their growth, demands, doctrines, etc., see *The Labor Movement: The Problem of To-Day*, edited by George E. McNeill (Boston, 1887); *The Story of Manual Labor*, by John Cameron Simonds (Chicago, 1886); *Thirty Years of Labor*, by T. V. Powderly (Columbus, Ohio); *The Labor Movement in America*, by Richard T. Ely, Ph.D. (New York, 1886); also the following works by the writer: *An Historical Sketch of the Knights of Labor*, published in *Quarterly Journal of Economics* for January, 1887; *The Amalgamated Association of Iron and Steel Workers*, published in *Quarterly Journal of Economics* for July, 1893; *Industrial Evolution of the United States* (Meadville, Pennsylvania, 1895).

CARROLL D. WRIGHT.

LABOR PARTIES. As far back as 1825, when the establishment of manufactures, the building of turnpikes and canals, the growth of population, the rise of great cities and the rush of emigrants from Europe led to the appearance in this country of a laboring class, efforts were made to bring the workingmen into politics. Now and again, from that time down to the war, labor questions were agitated in the states and labor conventions held. But it was not till the country entered on that extraordinary career of industrial growth which began with the Civil War, that labor questions assumed national importance.

In 1865 the first national labor congress was held, at Louisville, Kentucky, at which some twenty-five delegates were present. In 1866 a second congress met, at Baltimore, a third at Chicago in 1867, and a fourth at New York in 1868, to which came women-suffragists and labor-reform agitators. The next was held at Philadelphia, in 1869, when it was decided to hold a great national labor congress at Cincinnati on Aug. 15, 1870. The platform there adopted is too long to quote, but among its demands were lower rates of interest; a repeal of the national banking act; the withdrawal of national banknotes and the issue of paper currency "based on the wealth of the nation," and a legal tender for all debts public and private, and convertible into United States bonds bearing three per cent interest; eight-hour laws; exclusion of the Chinese; no land-grants to corporations; and the immediate formation of a "National Labor-Reform Party."

The idea of a new party was heartily approved, and from the National Labor Congress of 1871,

which met at St. Louis, came a formal call for a national nominating convention.

**LABOR-REFORM PARTY.** The convention thus called was held at Columbus, Ohio, Feb. 21, 1872, and nominated David Davis and Joel Parker. Each declined, and at a second convention or conference, at Philadelphia, August 22d, Charles O'Connor was nominated for president, but no one for vice-president.

With 1873 came the panic, and the country entered on a period of business depression, hard times and steady reduction of wages. Low wages bred discontent, which was fomented by the work of every sort of communistic and socialistic society in the country, till, in 1877, it took shape in the greatest strike in the history of labor. As probably every workingman was a voter, a desperate effort was now made by the socialists and politicians to use the prevailing discontent for political purposes. In Louisville a Workingman's Party was organized at once, and several members of the Kentucky legislature were elected by it. The platform demanded an eight-hour law, courts of arbitration, lower taxes and compulsory education. In Ohio a workingman's state ticket was put in the field. In New York the Bread-Winners' League issued a call for an independent labor party, and demanded that the government control the railroads and that greenbacks be issued in place of bank-notes.

At Baltimore a convention formed "The Labor Party of the United States." At St. Louis "The United Workingman's Party" already existed.

So far, little effort had been made toward a national party, but in 1878 the first step was taken by the union of the labor-reform parties in such states as Massachusetts and Pennsylvania (September, 1877) with the Greenback party and by the calling of a national convention of these two at Toledo, Ohio, on Feb. 22, 1878, when

**THE NATIONAL PARTY**, or, as it was commonly called, "The Greenback-Labor Party," was founded.

The platform, of course, consisted of two parts: That furnished by the Greenbackers called for—1. Withdrawal of all currency issued by state and national banks and corporations. 2. That coin should not be paid for the principal or interest of the national debt, unless specifically promised. 3. That the only currency should be paper issued by the government on the faith of the nation and convertible into bonds bearing 3.65 per cent interest, and be a full legal tender for all dues, debts and taxes.

The part furnished by the labor-reform element demanded—4. That government bonds should be taxed. 5. No land grants to corporations. 6. Reduction of the hours of labor. 7. National and State labor bureaus. 8. Abolition of the contract prison-labor system. 9. Exclusion of the Chinese.

At the election of 1878 the National party polled 1,000,365 votes in 37 states, as against 187,095 votes in 15 states in 1877 and 82,640 votes in 24 states in 1876, and elected 14 Con-

gressmen. Its greatest growth was in California, Iowa, Maine, Massachusetts, New York, Pennsylvania, West Virginia, Georgia and Missouri.

Encouraged by this success, a national convention was called to meet at Chicago, where, June 9-10, 1880, James B. Weaver of Iowa and B. J. Chambers of Texas were nominated. The platform was that of 1878, with the addition of a few new demands for an eight-hour labor law, the sanitary inspection of factories, workshops and tenements.

But the prosperity of the party was on the decline; the popular vote polled was but 306,867, and the number of Congressmen elected but eight. Of these, four came from Missouri, two from Maine, and one each from New York and Texas.

In 1884 the party nominated Benjamin F. Butler of Massachusetts and Absalom W. West of Mississippi, and polled but 133,825 votes in 30 states, and practically went out of existence.

**UNION-LABOR PARTY.** This party was formed at Cincinnati on Washington's Birthday, 1887, at a convention of delegates representing such organizations as the Knights of Labor, the Agricultural Wheelers, the Corn-Growers, Farmers' Alliance, Homesteadery, Grangers and Greenbackers. It was opposed to land monopoly in every form; it demanded the public ownership of telegraphs and railroads; it called for a currency issued by the government directly to the people without the intervention of banks, and loaned on landed security at a low rate of interest; for the free coinage of gold and silver; the immediate payment of the bonded debt; a graduated income tax; the exclusion of the Chinese; the election of United States Senators by popular vote, and the extension of the franchise to women.

Thus formed, and on this platform, the Union-Labor party (made up chiefly of the old Greenback-Labor men) entered the campaign of 1887 with state tickets in Ohio, Arkansas and Missouri. The vote polled was so encouraging that in the autumn of 1888 there were Union-Labor tickets in nearly all the Western states, and a Presidential ticket nominated at Cincinnati in May, 1888, by a national convention of 274 delegates from 25 states. The candidates were Alson J. Streeter of Illinois and Charles E. Cunningham of Alabama.

**UNITED-LABOR PARTY.** Side by side with the Union-Labor party grew up another, which sprang directly from the Henry George movement in New York City in 1886, and after supporting him for Secretary of State in 1887, called a national convention, to meet at Cincinnati and nominate a Presidential ticket. The delegates, ninety-nine in number, assembled May 16, 1888, nominated Robert H. Cowdery of Illinois for President and William H. T. Wakefield of Kansas for Vice-President, and drew up a platform. The chief features of it were declarations against land monopoly, and in favor of taxing land according to its value and not its area; a circulating medium

issued by the government without the intervention of banks; government control of railroads and telegraphs; less hours of labor; sanitary inspection of tenements, shops and mines; the Australian ballot; and a reduction of the cost of legal proceedings.

An effort to join these two labor parties was a failure, and each was absorbed in 1890 by the People's Party.

**SOCIALISTIC-LABOR PARTY.** The Socialistic-labor party held its national convention at New York City in August, 1892, and nominated Simon Wing of Mississippi and Charles H. Matchet of New York. The platform consisted of two parts:

I. *Social Demands.* 1. Less hours of labor. 2. Government ownership of railroads and telegraphs. 3. Municipal ownership of gas, ferries, electric plants and street railways. 4. The United States to have sole right to issue money. 5. No patents; inventions to be remunerated by the nation. 6. Repeal of pauper, tramp and conspiracy laws. 7. Equal wages for men and women. II. *Political Demands.* 1. Abolish the Presidency, Vice-Presidency and Senate, the House of Representatives to elect an executive board. 2. Direct vote; secret ballot; equal suffrage for men and women, black and white.

At the election the party polled 21,191 votes, namely, Connecticut, 329; Massachusetts, 676; New Jersey, 1,337; New York, 17,965; Pennsylvania, 898.

J. B. McMASTER.

**LABOUCHERE, HENRY**, an English journalist and politician; born in 1831. He was educated at



HENRY LABOUCHERE.

Eton; entered the diplomatic service in 1854, through the influence of his uncle, the late Lord Taunton; and was successively attaché at Washington, Munich, Stockholm, Frankfort, St. Petersburg, Dresden and Constantinople; was elected a member of Parliament for Windsor in 1865-66; for Middlesex in 1867-68, and for Northampton since 1880, with Charles Bradlaugh for his co-member. Mr. Labouchere was rated as an advanced Gladstonian Liberal, with strong independent tendencies; so in Lord Rosebery's ministry and after it he must be classed as an advanced radical. His opposition to the very existence of the House of Lords manifested itself on all possible occasions. He edited and owned *Truth*, a society paper of very general influence, and was part proprietor of the *Daily News*.

**LABOULAYE, EDOUARD RENÉ LÉFEBVRE DE**, a French author, born in Paris, France, Jan. 18, 1811; began life as a type-founder; at 28 he published *History of Landed Property in Europe*, which attracted great attention, and was crowned by the Institute. In 1842 he was admitted to

the Paris bar, and in 1849 became professor of comparative legislation in the College of France. During the empire, his opposition to the despotic methods of Napoleon III was moderate in form but untiring in act. He never ceased presenting to his audiences the United States constitutions as models for a future French republic, and during the Civil War took openly the side of the Union against the secessionists. In 1871 he was elected to the National Assembly for the department of the Seine; in 1875 he became a life-Senator, and in 1876 was made administrator of the College of France and shortly afterward resumed the lectures that had made him so popular under the Second Empire. Among his works are *Political History of the United States* (1855); *The United States and France* (1862); and *Memoirs of Franklin* (1866). His *Paris en Amérique* (1863) is a clever plea in favor of American customs, under cover of a humoristic fiction. The sons of Laboulaye gave the library and manuscript lectures of their father at the College of France to Johns Hopkins University. He died in Versailles, May 25, 1883.

**LABOURDONNAIS, BERTRAND FRANÇOIS MAHE DE**, a French sailor and colonial governor; born in St. Malo, France, Feb. 11, 1699; he entered the royal navy early, and reached the rank of captain in 1723; after serving some time in the Portuguese navy he was appointed governor of the French islands of Isle de France (Mauritius) and Bourbon (now La Réunion), and developed greatly the prosperity of these colonies. During one of the Franco-English wars he bombarded Madras, in 1746, and levied a contribution on the East India Company of £540,000. The jealousy of Duplein, the governor-general, caused him to be dismissed from the service and imprisoned in the Bastille for three years. Finally he was acquitted, in 1751, and later his widow was pensioned. He is mentioned with much praise in Bernardin de St. Pierre's admirable prose-poem, *Paul et Virginie*. He died Sept. 9, 1753.

**LABRADOR**, a dependency of Newfoundland, and under the administrative supervision of the governor of that island. The latest official reports place the area at about 56,000 square miles, and the population at 4,211. Included in the population of Labrador were 609 Indians. The statistics of trade and productions are reported in connection with those of Newfoundland. See also **LABRADOR**, Vol. XIV, p. 175.

**LABRADORITE.** See **MINERALOGY**, Vol. XVI, p. 420.

**LABYRINTHODONTA.** See **AMPHIBIA**, Vol. I, pp. 761-62.

**LACEBARK-TREE** (*Lagetta lintearia*), a tree of the family *Thymelacaceæ*, a native of the West Indies. The inner bark of the tree has the appearance of coarse lace, and is used in weaving.

**LACERTIDÆ.** See **LIZARD**, Vol. XIV, pp. 732-734.

**LACERTILIA.** See **REPTILES**, Vol. XX, p. 439, et seq.

**LA CHAISE, FRANÇOIS D'AIX DE**, a French

Jesuit; born in the Château d'Aix, France, Aug. 25, 1624. He entered the order of Jesuits, and by the influence of Father Coton, his uncle, rapidly rose to the office of Provincial; appointed confessor of Louis XIV, he closed his eyes to the court-scandals, but incited the persecution of Protestants, being mainly instrumental in the revocation of the Edict of Nantes in 1685, and causing trouble to all adherents of the Gallican Church. He was given by the king fine grounds in the eastern suburbs of Paris, whereon he built himself a summer residence. These gardens have since been turned into into the handsomest of Parisian cemeteries, and named after Pere La Chaise. He died in Paris, Jan. 20, 1709. See also FRANCE, Vol. IX, p. 579.

LACHES, a law term signifying negligence, or remissness in asserting or enforcing a right. Where a remedy is discretionary, and not compulsory, laches on the part of the person seeking to enforce the remedy will prejudice and sometimes defeat his case. In courts of equity the maxim is, "Equity aids the vigilant, but not the indolent." Laches is only excused if the party is laboring under a legal disability, as insanity, coverture (a *feme covert*, or married woman, has no right to sue in her own name), infancy (if the party had not attained legal majority), imprisonment and the like. No laches can be imputed to a state.

LACHESIS. See SNAKES, Vol. XXII, p. 199.

LACHINE, a town of Hocheloga County, Quebec, Canada, situated on a railroad, eight miles above Montreal, and connected by a bridge with Caughnawaga. A ship canal eight and one half miles long extends hence to Montreal harbor, to avoid the Lachine Rapids of the St. Lawrence. It is a favorite summer residence, and a place of resort for pleasure parties during the winter. A steamer shoots the rapids daily, and the trip is very popular among tourists. See ST. LAWRENCE, Vol. XXI, p. 181.

LACHLAN, a river of New South Wales, Australia, rising in King County. It flows west, and joins the Muerrenabidgee, a tributary of the Murray, in lat. 34° 25' S., long. 144° 4' E. Length, 700 miles. Navigable in rainy season for light-draught boats.

LACHRYMAL APPARATUS. See ANATOMY, Vol. I, p. 891; DISEASES OF, see OPHTHALMOLOGY, Vol. XVII, p. 786.

LACKAWANNA OR LACKAWANNOCK, a river of northeastern Pennsylvania, rising in Susquehanna County, flowing southwest and entering the Susquehanna at Pittston. Its basin is a very productive coal region, whence one half the anthracite coal of the United States is obtained. It is 40 miles in length. Scranton and Carbondale, important mining towns, are the largest on the river.

LACKMUS. See LITMUS, Vol. XIV, p. 703.

LA CLEDE, PIERRE LIGNESTE, a French explorer; born at Bion, France, in 1724. The company over which he ruled had obtained in 1762 from Governor d'Abbadie the exclusive right to

trade with the Indians on the Missouri River. His lieutenant, Auguste Chouteau, chose the present site of St. Louis for a trading-post, and, having fortified it, gathered there the stores of the company, Feb. 15, 1764—practically the date of the founding of St. Louis. It was named by La Clede, a month later, in honor of King Louis XV. He died on the Mississippi River at the mouth of the Arkansas, June 20, 1778.

LACON, a city and the capital of Marshall County, northern central Illinois, on the Illinois River, and on a branch of the Chicago and Alton railroad. It is a grain shipping point, contains a distillery, a shawl, woolen and flour mills, and a canning-factory. The Illinois River is navigable here for steamboats. It is supplied with electricity and city water. Population 1900, 1,601.

LACONIA, a town, and the capital of Belknap County, New Hampshire, on Lake Winnisquam and the Boston and Maine railroad. It has manufacturing of hosiery, flannel, yarn, etc. Population 1890, 6,143; 1900, 8,042.

LACRETELLE, PIERRE LOUIS, a French author; born in Metz, France, in 1751. When 27 years old he left Nancy, where he was practicing law, to enter the Paris bar; there he was in frequent intercourse with La Harpe, Malesherbes and their literary coterie. He took part in the revolution as a moderate, and barely escaped the guillotine. He confined his labors to his profession and to literature, except under the Restoration, when the newspapers he wrote for were suppressed for their persistent opposition to all reactionary measures. His *Portraits et Tableaux*, *Études sur la Révolution Française*, and *Mes Soirées à Malesherbes*, give trustworthy pictures of the troubled times in which he lived. He died Sept. 5, 1824.

LACROIX, PAUL, a French writer, better known by his pen-name of "Le Bibliophile Jacob"; born in Paris, Feb. 27, 1806; was educated at the College Bourbon; while still at school he began to prepare editions of the old French classics. It was in the field of historical research, however, that he won reputation as a writer. His books on history and on bibliography treat in attractive fashion of the habits, manners, customs, costumes, arts, sciences, and intellectual condition of France from the middle ages down to the nineteenth century. From 1855 Lacroix was custodian of the Arsenal library of Paris. He was a decided liberal in his principles, and a personal friend of the stubborn adversaries of the Second Empire, Victor Hugo, Charras, Louis Blanc, etc. He died in Paris, Oct. 16, 1884.

LA CROSSE, a city and the capital of La-Crosse County, southwestern central Wisconsin. It is a great lumber center; a great many logs are floated down the Black River and here converted into lumber. Four railways center here, the Chicago, Burlington and Northern, the Chicago, Milwaukee and St. Paul, the Chicago and Northwestern and the Green Bay, Winona and St. Paul. The city stands on a sandy tract, and is spread over a large area. Large quantities of grain

and other farm products are shipped by rail and river. La Crosse has many manufactories, mostly those of wooden articles. Invested in them is an aggregate capital of \$11,000,000. Their annual product averages \$10,000,000 in value. The city contains 50 churches, public halls, opera-houses, a public library containing over fifteen thousand volumes, and electric lights and street-railways. The population in 1890 was 25,221; 1900, 28,895. See also LA CROSSE, Vol. XIV, p. 195.

LACTEALS. See ANATOMY, Vol. I, pp. 906, 907.

LACTOMETER. See ADULTERATION, Vol. I, p. 168.

LACTUCARIUM. See NARCOTICS, Vol. XVII, p. 231.

LA CYGNE, a post village of Linn County, central eastern Kansas, 52 miles S. of Kansas City, on the Osage River, and on the Kansas City, Fort Scott and Memphis railroad. It has superior water-power, and manufactures considerable lumber. It is surrounded by a fruit-growing and stock-raising region, and has valuable coal and building-stone in its vicinity. Population 1890, 1,135; 1900, 1,037.

LADANUM or LOBDONUM, resinous exudation from the "Rose of Sharon" (*cistus cretica laurifolius*, and *lodiniferous*). This is the myrrh of the Hebrews. It has been used as a perfume throughout historic times, and is still an article of commerce in Turkey. See also INCENSE, Vol. XII, p. 718.

LADD, GEORGE TRUMBULL, an American educator; born in Painesville, Ohio, Jan. 19, 1842; graduated at Western Reserve College in 1864 and Andover Seminary in 1869. Served as pastor of Congregational churches in Edinburgh, Ohio, and Milwaukee, Wisconsin, until 1879, when he was appointed professor of intellectual and moral philosophy in Bowdoin, and lecturer at Andover Seminary. In 1881 he was called to the chair of philosophy in Yale. He wrote *Principles of Church Polity* (1881); *Doctrine of Sacred Scripture* (1883); and *Elements of Physiological Psychology* (1887).

LADIN, dialect. See ENGADINE, Vol. VIII, pp. 213, 214.

LADISLAUS, King of Naples, surnamed "The Liberal and the Victorious"; was born about 1375, and in 1387, under the regency of his mother, succeeded his father Charles III; was driven from the city in July of that year by his rival to the throne, Louis II of Anjou, who was supported by Pope Clement; was reinstated by Otto of Brunswick a few weeks later; repulsed two invasions made by Pope Urban VI, in 1388; was crowned at Gaeta, May 29, 1390, by a legate of the new Pope, Boniface IX; a candidate for the Hungarian throne, and crowned in 1403, but soon withdrew his claims thereto; attempted to besiege Rome in August, 1405, for which he was excommunicated and deprived of his kingdom by the Pope, June 18, 1406; again made an attack on Rome, in 1406, and finally took the city by surprise and plundered it, June 8, 1413. During

his career he was also a claimant to the throne of Provence and a candidate for the imperial crown of Germany. He was probably the first of the modern Italian rulers who entertained the project of united Italy. He died in Naples, Aug. 16, 1414.

LADISLAUS, the name of seven kings of HUNGARY; q.v. Vol. XII, pp. 367-69.

LADISLAUS OR WLADYSLAW, the name of two kings of POLAND; q.v. Vol. XIX, p. 289.

LADRONES OR MARIANA ISLANDS. See Vol. XIV, pp. 199-200; and GUAM, in these Supplements.

LADY-BIRD. See COLEOPTERA, Vol. VI, 128, 134.

LADY FRANKLIN BAY, an inlet into the coast between Grant Land and Grinnel Land, and between lat. 80° and 81° N., opening into Robeson Channel. It was the station of the unfortunate United States Signal Service expedition of 1881-1883.

LADY'S MANTLE, a name given to *Alchemilla*, an Old World genus of herbaceous plants of the family *Rosaceæ*. The common lady's mantle (*A. vulgaris*), abundant throughout Great Britain and cultivated in the United States, has a bitterish, astringent taste. Formerly it was used in medicine as an astringent.

LADY'S SLIPPER, an orchid of the genus *Cypripedium*. The corolla has a large inflated lip, thought to resemble a slipper. In America the most conspicuous wild lady's slippers are the larger yellow *C. pubescens*; the smaller yellow *C. parviflorum*; the showy *C. spectabile*; and the stemless *C. acaule*. The roots of the first yield an officinal remedy, regarded as a nervous stimulant and anti-spasmodic. See Vol. XVII, p. 818.

LADYSMITH, SIEGE OF. Ladysmith is an inland town of Natal, noted for its 118 days' siege by the Boers in Britain's war (1889-1900) with the late South African republics. The town is situated on a plain, commanded by high hills, and watered by the Klip River. It is distant about 190 miles from Port Durban and 119 miles from Pietermaritzburg, the capital of the Colony. To understand how Ladysmith came into prominence in the struggle here related, it may be well first to recite, briefly, the opening incidents in the conflict between Briton and Boer. When the war broke out (Oct. 10, 1899), a small British force was stationed at Newcastle, to the northward of Ladysmith, near the passes in the Drakensburg mountains where the northern wedge-shaped portion of the Natal Colony impinges upon the Transvaal. From Newcastle the British withdrew on Oct. 13, to escape being taken in the rear by the Boer troops that in large force had invaded northern Natal, seizing Laing's Nek and the ill-omened region for the British of Majuba Hill and the Ingogo. The small retreating British force was under General Sir W. Penn Symons, who awaited reinforcements from England and the East Indies. Just before these arrived and General Sir George White took command, the English gave battle (Oct. 20) to the Boers at Dundee, 35 miles from Ladysmith and connected with it by railway. Though Dundee was won by the British, it cost them dear, especially in the storming of Talana

Hill, for they were now opposed by the large burgher levies under Generals Joubert, Meyer, and Kock. As General Symons had fallen at Dundee, General Yule took command. Being, however, hard-pressed and short of ammunition, and hoping also to receive reinforcements, now being brought northward from the coast by Sir George White, General Yule decided to fall back upon Ladysmith. Meanwhile, General French, in command of another British column, including the 5th Lancers and the Imperial Light Horse, had beaten a large force of the Boers plying heavy guns at Elands-laagte; while Sir George White, who had now arrived at Ladysmith, had had an action with the enemy at Rietfontein, with the view of enabling General Yule to get back to the British railway and supply base near the Klip River. The British, having suffered heavy losses, and the varied columns being wearied with hard marching and counter-marching, all concentrated at Ladysmith. As the whole of Natal was now menaced in force by the burgher levies, General White elected to hold Ladysmith with his entire command, to prevent further invasion southward of the Colony. This command consisted of about 11,000 men, including 2,400 troopers, with 48 guns. Against this force and to invest the place, the Boers brought up an army some 20,000 strong, and proceeded to cut off all railway and telegraphic communication with the town. Now ensued the 118 days' exciting siege, with all its attendant horrors, the results of bombardment, deaths from casualties, enteric fever, and other sicknesses, and towards the end lack of food and exhausted hospital stores, and ammunition reduced to fifty rounds. To add to the drawbacks of the situation, the beleaguered garrison lost by death and capture in a sortie in the early days of the siege some 2,000 comrades. Of the remaining 9,000 troops, two-thirds of whom ere the siege was raised had passed through the hospital, 600 were killed or wounded, 350 died from diseases, while all were emaciated and enfeebled. In addition to these casualties, the citizens of the town suffered a loss of 120 of their number in killed or wounded. Towards the close of Feb. (1900), relief at length came in the welcomed approach of General Buller's army corps, which had had much hard fighting and had met with many serious reverses in relieving Natal of the Boer forces and in enabling the Earl of Dundonald, with his cavalry division, to enter Ladysmith on the evening of Feb. 28, amid the acclaims of the besieged and the rejoicings of the entire British nation.

Some critics, since the relief of the place, have taken Sir George White to task for his decision to shut himself and his troops in Ladysmith and for attempting to defend so vulnerable and exposed a town. The criticism, from a military point of view, is not to be found fault with; yet it must be remembered that Ladysmith had hitherto been a garrison town and base of supplies, and to Sir George White it no doubt appeared a weakness to give the place up to be looted by the Boers, in addition to the more advanced towns in the colony from which the British had withdrawn; while re-

lief, if he thought of the necessity of that at all, and of a prolonged siege, would surely, he might imagine, be quickly forthcoming. The loss of *morale* in deserting the place and seeking safety further south, was no doubt the matter that weighed with him, besides consideration for the British colonists and loyal Dutch in Natal, who were naturally alarmed at the menace of invasion. The natural barrier of defence, it may be admitted, is the rugged valley of the Tugela River, to the rear of Ladysmith, from the hills overlooking which the Boers held General Buller so long and tightly while Ladysmith famished. At the same time, as we have hinted, desertion of the town would have entailed a moral loss and lowered British prestige; while the defence of the place, as it turned out, has added a glowing chapter to the annals of British military history and shown the world how undauntedly the British soldier can fight and endure, however hard and even intolerable his environment. What that environment was in Ladysmith during the siege, the war correspondents have with telling effect related. In dealing with the dramatic hours of the afternoon of Feb. 28, when the relieving column entered Ladysmith, one of these correspondents, Mr. Richard Harding Davis, has sketched for us "the pitiful contrast which the two forces presented. The men of the garrison were in clean khaki, pipe-clayed and brushed and polished, but their tunics hung on them as loosely as the flag around its pole, the skin on their cheek-bones was as tight and as yellow as the belly of a drum, their teeth protruded through parched, cracked lips, and hunger, fever, and suffering stared from out their eyes. They were so ill and so feeble that the mere exercise of standing was too severe for their endurance, and many of them collapsed, falling back to the sidewalk, rising to salute only the first troop of each succeeding regiment of the relieving force." For months, it will be remembered, the garrison had been reduced to a diet of horse flesh, with the occasional luxury of a small dish of corn-starch, with bluing in it, originally intended for washing clothes!

G. M. A.

LAEKEN, a suburb of Brussels, Belgium.

LA FARGE, JOHN, an American artist; born in New York City, March 31, 1835; a pupil of Couture, in Paris, and of William Hunt, in New York. He was first a draughtsman on wood, then a painter of flowers, landscapes and portraits, and afterward became noted as a decorator of church interiors and a mural painter on Biblical themes. He was elected a National Academician in 1869, was awarded a first-class medal at the Paris Exposition of 1889 for his stained-glass exhibit, besides being made a Knight of the Legion of Honor. Among his finest efforts are decorative paintings in Trinity Church, Boston, and St. Thomas Church and the Church of the Ascension, New York, and the battle-window (stained glass) in Memorial Hall, Harvard.

LAFAYETTE, a town and the capital of Chambers County, central eastern Alabama, situated 67 miles N. E. of Montgomery, on the Central railroad of Georgia. It has a good cotton



trade, and contains Lafayette College for women, churches, hotels, and a newspaper office. It has a large cotton trade, and also a general trade with a large cotton-raising and grazing region. Population 1890, 1,369; 1900, 1,629.

LAFAYETTE, a city and the capital of Tippecanoe County, western central Indiana, 63 miles N.W. of Indianapolis. It is on the Cleveland, Cincinnati, Chicago and St. Louis, the Lake Erie and Western, the Louisville, New Albany and Chicago and the Wabash railroads, and on the Wabash and Erie canal. It is supplied with natural gas led from Tipton County, with electric lights and street-railways, and a regular fire department. Population 1900, 18,116. See LAFAYETTE, Vol. XIV, p. 201.

LAFAYETTE, a town and the capital of Lafayette Parish, central southern Louisiana, on the Vermillion Bayou, and on the Southern Pacific railroad, 30 miles S.W. of Baton Rouge. It is in a cotton-growing region, sugar-cane and corn being also largely produced. Mt. Carmel Convent, an institution with over 150 students and 10 instructors, is situated here. Population 1900, 3,314.

LAFAYETTE, FORT. See NEW YORK CITY, Vol. XVII, p. 459.

LA FAYETTE, MARIE MADELEINE PIOCHE DE LA VERGNE, COMTESSE DE, a French novelist; born at Le Havre, France, 1634. She married at 21, Count de LaFayette, who brought her to Paris and introduced her to the cultured coterie that made its headquarters at the Hotel de Rambouillet, and from which Cardinal Richelieu was to recruit the founders of the Académie Française. She devoted much time to writing fiction, and, thanks to her masters, Ménage, Segrais, etc., she escaped the affected, stilted style that preceded the sober diction of the reign of Louis XIV. Her novel *La Princesse de Clèves* (1678) is remarkably fine and true to life, her short stories *M<sup>lle</sup> de Montpensier* (1662) and *La Comtesse de Tende* (1680) not being esteemed so highly by modern critics. Her *Histoire de Madame Henriette d'Angleterre* and her *Mémoires de la Cour de France pour les Années 1688-89* are considered documents of real value. The mutual attachment that lasted so long between her and the Duc de la Rochefoucauld (author of the *Maximes*) is also a matter of history. She died in Paris, in 1693.

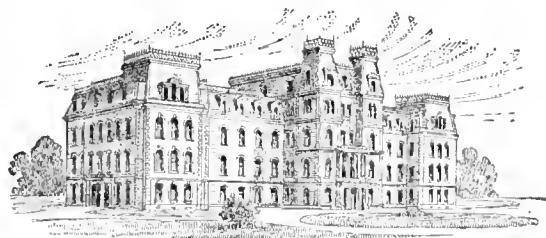

PARDEE HALL, LAFAYETTE COLLEGE.

LAFAYETTE COLLEGE, an American institution for the education of men, situated at Easton, Pennsylvania; opened in 1832, though char-

tered by the state six years earlier; controlled by the Presbyterian Church. In 1895 it had 28 instructors, 301 students, and 25,000 volumes in its library. Besides the regular curriculum in the liberal arts, instruction and degrees are given in the sciences, and in civil and electrical engineering. With the presidency of Dr. William C. Cattell (1863-83), it began to develop on new and stronger lines, a technical school, fully equipped, being added to it through the generosity of Mr. Ario Pardee. The grounds extend over 40 acres and the buildings number 27. The value of the assets is said to exceed \$1,000,000; the productive funds in 1895 amounted to \$302,000 and the annual income was \$36,000.

LAFITTE, JACQUES, a French banker and financier; born of humble parents, at Bayonne, Oct. 24, 1767. He left his home in 1787, walked to Paris, and in the following year was employed as bookkeeper in the banking-house of Perregaux; was soon admitted to the firm, and in 1809 succeeded to the business. He became a regent of the Bank of France in the same year; in 1813, a member of the Tribune of Commerce; in 1814, president of the Chamber of Commerce and governor of the Bank of France. During the stormy years that followed, his honesty and liberality did much toward averting financial disasters. He was respected and his services made use of by all parties. He was banker for Louis XVIII, and also for Napoleon during the Hundred Days, discharging both trusts with perfect honesty. In 1816 Lafitte was elected to the Chamber of Deputies, and in 1830 secured the election of Louis Philippe and averted a revolution by reconciling Lafayette with the latter. He became premier and Minister of Finance in the new Cabinet, but resigned in 1831, his liberal sentiments not permitting him to retain office longer. His banking-house failed in the financial panic of the next year, but out of his private fortune of 50,000,000 francs he was enabled to pay all liabilities, and with 8,000,000 francs remaining to start a new house. He was re-elected to the Chamber in 1843. He died May 26, 1844.

LAFITTE, JEAN AND PIERRE, two American buccaneers, born in France about 1780. The brothers went to New Orleans and set up a blacksmith shop, but left this occupation to engage in privateering expeditions against the Spanish mercantile traffic in the Gulf under commissions from the French, and later from the Republic of Colombia. They made their headquarters on the island of Grande Terre, about 35 miles west of the mouth of the Mississippi, selling their booty by auction to the merchants of New Orleans. It was very probable that they did not confine depredations to the commerce of the enemies of the governments which employed them, but in fact were mere pirates. In 1814 Jean Lafitte was offered a commission and a pardon for past offenses if he would enter the service of the British in the siege of New Orleans, Pierre Lafitte being in prison in that city on the charge of piracy. He, however, rejected the offer, and tendered

his services to the United States on the same terms. The offer was rejected by Governor Claiborne, of New Orleans, and an expedition fitted out against him and his brother who had escaped from jail, which destroyed their stronghold and carried off the greater part of their booty. Upon his arrival in New Orleans, General Jackson received another offer from the brothers, procured their pardon, and took them into his service. After the war they removed to Central America, where it was believed that they continued their old free-booting occupation. Jean Lafitte died about 1826, on the coast of Yucatan. A *Historical Sketch of Pierre and Jean Lafitte* was contributed to the *American Magazine of History*, October and November, 1883, by Charles Gayarré.

LAFOURCHE, a bayou of southern Louisiana, leaving the Mississippi near Donaldsonville, and flowing southeast to the Gulf of Mexico. Length, 150 miles; navigable for 100 miles from its mouth. It is bordered by great cotton and sugar-cane plantations.

LAFUENTE, MODESTO, a Spanish historian and critic; born at Rabanel de los Caballeros, May 1, 1806. He studied at Leon and Santiago de Compostela; became professor at Astorga in 1830; in 1838 went to Madrid and entered journalism. He published numerous critical essays, and his great work, *Historia de España*. He died Oct. 5, 1866.

LAGARDE, PAUL ANTON, a German theologian and orientalist; born in Berlin, Dec. 2, 1827. He graduated at Berlin and Halle; studied for two years in Paris and London; was professor successively in the Werder Gymnasium in Berlin, in the Polytechnic Institute in the same city, in the gymnasium at Cologne, and again in the Werder Gymnasium. In 1869 he became professor of oriental languages at Göttingen. He published, among other works, *Reliquiæ Juris Ecclesiastici Antiquissimæ* (1856); *Constitutiones Apostolorum Græcæ* (1862); *The Programme of the Prussian Conservative Party* (1884); *Upon Certain Berlin Theologians* (1890); and several critical works on the Old Testament.

LAGERSTRÆMIA, a genus of plants of the family *Lythraceæ*, distinguished by winged seeds, and containing some of the noblest trees of tropical forests. *Lagerstræmia Flos-reginæ*, or queen's flower, is the jarul of India, a magnificent tree with red wood, much used for boat-building.

LAGOA DOS PATOS, the largest lake of Brazil, situated in the extreme southern state of the country. It is 144 miles long, and 41 in extreme breadth, and runs parallel with the Atlantic, from which it is only separated by a long, low range of sand-dunes and swamps. Its outlet is at the southern end, and is called the Rio Grande do Sul. The lake as a rule is shallow, but has a channel for ships of heavy draught. The tide is felt at its lower end, but very little salt water enters the lake proper. Its principal tributary is the Jacuhy.

LAGO MAGGIORE. See MAGGIORE, Vol. XV, p. 198.

LAGOMYIDÆ. See MAMMALIA, Vol. XV, p. 421.

LAGOON, a species of lake formed by the overflow of the sea or of rivers, or by the infiltration of their water; hence lagoons are sometimes divided into fluvial and marine. In some cases they are dried up in summer, in others they preserve throughout the whole year the character of stagnant, marshy pools, and in others the sea reunites them to itself in winter, but is separated from them in summer by a bar of sand or shingle. See LAKE, Vol. XIV, p. 217.

LAGOS, a city in the state of Jalisco, central Mexico, on a tributary of the Verde River, and on the Mexican Central railroad, 225 miles N.W. of Mexico. It is notable for its annual winter fair, and its extensive iron-ore deposits and opal mines. Population, 13,500.

LAGOSTOMINÆ, a subfamily of *Chinchillidæ*, whose only known species, the viscacha (*Lagostomus trichodactylus*), is a characteristic rodent of the pampas of South America. It is distinguished by a rat-like form, but with a bushy tail, the lip cleft, the fore feet four-toed and the hind feet three-toed.

LAGOTIS or LAGIDIUM, a genus of rodents of the family *Chinchillidæ*, inhabiting the Andes of Chili, Bolivia and Peru. They have long ears, long, bushy tail, and are about the size of a hare. They are often called the "rabbit-squirrel" and chinchas. They resemble the chinchillas in appearance and in habits.

LA GRANDE, a city of Union County, north-eastern Oregon; on two branches of the Oregon Railway and Navigation Company railroad, 39 miles N. of Baker City. It is in the Grande Ronde valley, a rich lumbering, farming and mining region, and ships large amounts of lumber, live-stock and grain; has several mills, and a roundhouse and repair-shops of the railroad. It has electric lights and water-works. Population 1890, 2,583; 1900, 2,991.

LAGRANGE, a city and the capital of Troup County, central western Georgia, 65 miles S.W. of Atlanta; on the Atlanta and West Point and the Georgia Southern and Florida railroads. It contains a furniture factory, banks, churches, two colleges for young women, and two other collegiate institutions for both whites and negroes. It has manufactories of flour, cotton-seed oil, guano, carriages, plows and castings. Population 1890, 3,090; 1900, 4,274.

LAGRANGE, a town, and the capital of LaGrange County, northwestern Indiana, 42 miles W.N.W. of Fort Wayne, on the Grand Rapids and Indiana railroad. It has high and normal schools, churches, pump, bee-hive, butter-tub and carriage factories, and saw, planing and flour mills. Population 1900, 1,703.

LAGRANGE, a city of Lewis County, north-eastern Missouri, on the Mississippi River, 175 miles N. of St. Louis. It has considerable river trade, very large rolling-mills for turning out railroad iron, flour and planing mills, tobacco factories, and is the seat of LaGrange College, a

Baptist institution chartered in 1859. This college has six instructors and over 200 students. Population 1890, 1,250; 1900, 1,507.

LAGRANGE, a city and the capital of Fayette County, southeastern central Texas, on the east bank of the Colorado River, on the Missouri, Kansas and Texas and the Southern Pacific railroads; thirty miles N.E. of Columbus. Steamboats can ascend the river to the place. It contains cotton mills and compresses, an oil-mill, carriage and wagon shops, and a large trade in corn. Population 1890, 1,626; 1900, 2,392.

LA GUAIRA. See GUAYRA, Vol. XI, p. 242.

LA HARPE, FRÉDÉRIC CÉSAR, a Swiss patriot; born at Rolle, Vaud, in 1754; studied at Tübingen, and became tutor to a young Russian nobleman; later, to the grandsons of Catherine II of Russia, Alexander, afterward emperor, and Constantine. In 1793 he was pensioned and returned to Switzerland. He took part in the revolution in his native canton, resulting in the calling in of the French troops, and the proclamation of the Lemanic Republic, which after the establishment of the Helvetic Republic was incorporated in it as the canton of Leman. He was a member of the Swiss Directory, 1798-1800, and was given the honorary title of general by Emperor Alexander of Russia, his former pupil. He died March 30, 1838. See also SWITZERLAND, Vol. XXII, p. 743.

LA HARPE, JEAN FRANÇOIS, a French critic and poet; born in Paris, Nov. 20, 1739. He began his literary career by the publication of poems entitled *Héroïdes* (1759); in 1768 became literary critic on the *Mercur de France*; elected to the Academy in 1776; in 1786 made professor of literature in the Lycée. He is best known for his series of lectures given in that institution on the *History of Literature, Ancient and Modern*, which was published in sixteen volumes (1799-1805). La Harpe was a zealous supporter of the revolution. In philosophy he was first a follower of Voltaire, but later became converted to Catholicism. He died Feb. 11, 1803.

LAHÖNTAN LAKE. See UNITED STATES, Vol. XXIII, pp. 794, 795.

LAISSEZ FAIRE THEORY. See GOVERNMENT, Vol. XI, p. 17; and POLITICAL ECONOMY, Vol. XIX, pp. 360-400.

LA JUNTA, a village and the capital of Otero county, southeastern Colorado, on the Arkansas River and on the Atchison, Topeka and Santa Fé railroad, at the junction of two of its lines, 65 miles E. of Pueblo. Its industry is farming and stock-raising. Pop. 1890, 1,439; 1900, 2,513.

LAKE CHARLES, a town and the capital of Calcasieu parish, southwestern Louisiana, on the Calcasieu River and on the Southern Pacific Company railroad and the Lake Charles and Leesville, and the Kansas City, Watkins and Gulf railroads; surrounded by a large orange-growing and lumbering district. It has saw, shingle and wood-working mills, car-shops, a sugar-refinery and an ice factory; and it is supplied with water-works and electric lights. Pop. 1890, 3,442; 1900, 6,680.

LAKE CITY, a town and the capital of Co-

lumbia County, northeastern Florida, surrounded by beautiful lakes containing excellent fish. It is on the Florida Central and Peninsular, the Gainesville and Gulf, the Savannah, Florida and Western and the Silver Springs, Ocala and Gulf railroads. It is the seat of the State Agricultural College and a Peabody school, and is a winter resort for invalids. It is in the Sea Island cotton district, and has a large trade in fruit, vegetables, lumber, turpentine and phosphates. Population 1890, 2,020; 1900, 4,013.

LAKE CITY, a town of Calhoun County, western central Iowa, on the Chicago and North-western railroad, 35 miles S.W. of Fort Dodge. It is in a corn, wheat and oat raising district, and dairying and cattle-raising are important industries. It has repair-shops of the railroad. Population 1890, 1,160; 1900, 2,703.

LAKE CITY, a town of Missaukee County, northwestern south Michigan, on a pretty inland lake, and on the Grand Rapids and Indiana railroad, 98 miles N. E. of Muskegon. It is in a farming and lumbering district, and has saw and shingle mills. Population 1900, 816.

LAKE CITY, a city of Lake county, southeastern Minnesota, on beautiful Lake Pepin, an enlargement of the Mississippi, and on the Chicago, Milwaukee and St. Paul railroad, 52 miles S. E. of St. Paul. It is a wheat market, and has manufactories of flour, plows, lumber and wagons, and has foundries, machine-shops and steam-elevators. It has a public library, and is quite popular as a summer resort. It occupies a picturesque site on a small plain between the lake and the bluffs. Population 1890, 2,128; 1900, 2,744.

LAKE DISTRICT OF ENGLAND, THE. See CUMBERLAND, Vol. VI, p. 699.

LAKE FOREST, a city of Lake County, northeastern Illinois, 28 miles N.W. of Chicago, on Lake Michigan, and on the Chicago and North-Western railroad. It contains Lake Forest University, Ferry Hall Seminary, a boys' academy, churches and elegant residences. It is spread along the lake for three miles, on beautiful high bluffs, and is one of the most picturesque places in the state. Population 1890, 1,203; 1900, 2,215.

LAKE FOREST UNIVERSITY, a co-educational institution, located partly in Lake Forest, Illinois, and partly in Chicago. It was founded in 1857 by a number of Chicago Presbyterians, under the name of Lind University. This was changed to Lake Forest University in 1865. In 1896 there were six distinct departments: the academy for boys, the college (co-educational), and Ferry Hall Seminary for girls, all located in Lake Forest; the three professional schools, Rush Medical, united with the University since 1887, Chicago College of Law since 1889, and Chicago College of Dental Surgery since 1887, all located in Chicago. The academy is a preparatory school; Ferry Hall is preparatory, but also has a two-years course, like the first two, in college. The college is organized upon the elective plan, a certain number of credits, including three years' work in elective subjects, being required for

graduation. The school owns, aside from its campus and equipment, income-bearing property to the amount of \$500,000, which, together with all sources of income, nets about \$85,000 a year. There were in 1898, in all departments, 1,393 students and 121 instructors, and the library had 16,000 volumes. The campus in Lake Forest includes 75 acres of land, and there are 15 buildings on it. President (1899), James G. K. McClure, D.D.

**LAKE GENEVA**, a city of Walworth County, southeastern Wisconsin, situated on a lake from which it takes its name, and on the Chicago and Northwestern railroad, 45 miles S.W. of Milwaukee. It has flour and feed mills, a postoffice fixture factory, and has a large trade in pork and wool. It has popularity as a summer resort. Population 1890, 2,297; 1900, 2,585.

**LAKE MÅLAR**, one of the largest lakes in Sweden, studded with upward of twelve hundred islands, mostly well wooded. Its east end is close by Stockholm, where its waters empty into the Baltic Sea. The shores are adorned with castles, country-seats and villas, including the royal palaces of Drottningholm and Gripesholm. See **SWEDEX**, Vol. XXII, pp. 736, 737.

**LAKE OF THE THOUSAND ISLANDS**, an expansion of the St. Lawrence, extending down the river for about forty miles from Lake Ontario. It contains the group called the Thousand Islands, some fifteen hundred rocky islets, belonging partly to Canada and partly to Jefferson County, New York, the largest, Wolf Island, measuring 21 miles by 7. These islands are very popular summer resorts. See **ST. LAWRENCE**, Vol. XXI, p. 1800.

**LAKE OF THE WOODS**, a large irregular lake in northern Minnesota and Canada, about sixty miles in diameter. It has several large wooded islands and numerous small ones. Its largest tributary is Rainy Lake River, which flows in from the east. Its outlet is Winnipeg River, which discharges its waters into Winnipeg Lake. Altitude 1,000 feet.

**LAKEPORT**, a village and the capital of Lake county, northwestern central California; situated on the west shore of Clear Lake, amidst very beautiful scenery, one hundred miles N. of San Francisco. It is in a fruit-raising region, and has medicinal springs and quicksilver mines. Some gold and silver are mined. Its picturesque situation makes it a popular tourists' resort. Population 1900 726.

**LAKEPORT**, a village of Belknap County, central New Hampshire, on Long Bay, at the outlet of Lake Winnepiscaukee, on the Boston and Maine railroad, two miles N. of Laconia. It derives water-power from the lake outlet, and has a foundry, machine-shop, and manufactories of hosiery, woolen goods and needles. Population 1890, 2,715.

**LAKES**, in coloring. See **PIGMENT**, Vol. XIX, pp. 87, 88.

**LAKE VALLEY MINES**. See **SILVER AND SILVER MIXING**, in these Supplements.

**LAKEWOOD**, a town of Ocean County, central eastern New Jersey, on the south branch of the Metedecong River, and on the Central railroad of New Jersey, twenty miles S.S.W. of Long Branch. Lumbering and the manufacture of charcoal, iron

from native ore, and farming are the principal industries. Lately, Lakewood has obtained popularity as a health and winter resort. It is situated in a large pine forest studded with many pretty lakes. It has four large hotels, electric lights, and the Lakewood Preparatory Academy. Population township (1900), 3,094.

**LALLEMAND**, CHARLES FRANÇOIS ANTOINE, a French general; born in Metz, June 23, 1774. He entered the army in 1792; served in Egypt, Spain and Russia; in 1811 was made baron and brigadier-general; upon Napoleon's return from Elba, lieutenant-general and member of the House of Peers. He was chosen by Napoleon to conduct negotiations for his surrender to Captain Maitland, and he afterward requested permission to follow the deposed emperor to St. Helena, but was refused and imprisoned at Malta by the British authorities; subsequently was released, and went to the United States with the intention of founding a colony for imperialist refugees in Alabama. The scheme proved a failure, and another attempt was made in Texas, which was frustrated by the Mexican authorities, who drove the colonists out of the country. In 1823 he took part in the Spanish war, and then went to France, where his military and political honors were restored him, and he took his seat in the Chamber of Peers. Afterward, for two years he was governor of Corsica. Lallemand was a legatee of Bonaparte's for 100,000 francs, but being at the time under the sentence of death by a French court, the bequest was refused him. He died in Paris, March 9, 1839.

**LAMAR**, a town and the capital of Barton County, southwestern Missouri, on Muddy Spring River, and on the Missouri Pacific and the Kansas City, Fort Scott and Memphis railroads, 60 miles W.N.W. of Springfield. It is in a fertile and productive agricultural region, where coal and timber are plentiful; has manufactories of flour, brooms, cigars and wagons, and has large nurseries. Population 1890, 2,860; 1900, 2,737.

**LAMAR**, LUCIUS QUINTUS CINCINNATUS, an American statesman; born in Putnam County, Georgia, Sept. 1, 1825; graduated at Emory College; studied law, and in 1847 was admitted to the Georgia bar; in 1849 became adjunct professor of mathematics in the University of Mississippi, but resigned the following year. He then returned to the practice of law in Covington, Georgia, and in 1853 was chosen to the state legislature. In 1854



LUCIUS Q. C. LAMAR.

he settled in Mississippi, and from 1857 to 1860 was a member of Congress. During the Civil War he fought with the Confederate army, was the representative of the Confederacy in Europe for securing financial aid and government recognition, and attained the rank of colonel. In 1866 he became professor of political economy in the University of

Mississippi, and in 1872 was again elected to Congress. In 1874 he was re-elected, and in 1877 became a United States Senator. During President Cleveland's first term he was Secretary of the Interior, and in December, 1887, became an associate justice of the United States supreme court. He died at Macon, Georgia, Jan. 23, 1893.

LAMARCKIANISM. See LAMARCK, Vol. XIV, pp. 231, 232; EVOLUTION, Vol. VIII, pp. 748-750; HEREDITY, and NEO-LAMARCKIANISM, in these Supplements.

LA MARMORA, ALBERT, COUNT DE, a brother of Alfonso, an Italian soldier and naturalist; born in Turin, in 1789; was educated at Fontainebleau, France, and served under Napoleon I. In 1821 he took part in the uprising in Piedmont, and in consequence was banished to the Island of Sardinia, where he remained nine years. He spent the time of his exile in a thorough study of the physical features of the island, especially its geology. The results of his investigations were published under the title *Travels in Sardinia*, the first volume of which was published in 1826, the third and last in 1857. In 1831 he was recalled by King Carlo Alberto, and was afterward sent back to Sardinia as royal commissioner to effect the reconciliation of the Separatist party. He died in 1863.

LA MARMORA, ALFONSO FERRERO, MARQUIS DE, an Italian general and statesman; born in Turin, Nov. 17, 1804. He was educated at the military academy at Turin; entered the Sardinian army in 1823 with the rank of lieutenant of artillery; subsequently visited almost every country in Europe for the purpose of military study, and became known as a zealous reformer of the army. He was decorated for distinguished services in the national war of 1848, and promoted general of brigade. In 1849 he entered the Sardinian Cabinet as Minister of War, withdrawing in 1855 to assume command of the Sardinian troops in the Crimea. At the close of the war he was invested with the Order of the Bath and the Grand Cross of the Legion of Honor, and re-entered the ministry in his former capacity. He took part in the war of 1859, by which Lombardy was acquired by Italy; was appointed commander-in-chief of the Italian army in 1861; and became Prime Minister in 1864. He was minister to Paris in 1867, and was governor of Rome in 1870-71. After 1873 he lived in retirement. His *Life* has been written by Massari. He died Jan. 5, 1878.

LAMB, MARTHA JOANNA READE NASH, an American authoress; born in Plainfield, Massachusetts, Aug. 13, 1829. She began writing at an early age, and in 1852 married Charles A. Lamb, and moved to Chicago. She was there the founder of the Home for the Friendless and the Half-orphan Asylum. In 1866 she moved to New York, and devoted all her attention to literature. In 1883 she became the editor of the *Magazine of American History*. Her best work is *The History of the City of New York* (2 vols., 1877-81), besides which she has written numerous historical sketches, novels and shorter stories, among which are *Spicy*, a novel (1873); *Play School Stories* (1874); *The Christmas Owl* (1881);

*Wall Street in History* (1883). She died Jan. 2, 1893, in New York City.

LAMBAYEQUE, a department of northwestern Peru, bordering on the ocean, the western Cordillera and the departments of Piura and Libertad. The coast part is low and rather arid, but the valleys are fertile and produce sugar-cane, tobacco, cotton and rice. The principal river is the Lambayeque, on which is the capital, Lambayeque, with a population of 8,000. Population of department in 1896, 124,091; area, 4,613 square miles.

LAMBERTVILLE, a city and railroad junction of Hunterdon County, northwestern New Jersey, on the Delaware River and on the Pennsylvania railroad, 14 miles above Trenton. It has excellent water-power, running cotton, paper, twine and spoke mills, and also a rubber and shoe factory, foundry, and railroad construction and repair shops. It has electric and gas lights. Population 1890, 4,142; 1900, 4,637.

LAMBIN, DENYS, a French bibliographer and editor; born at Montreuil, Vaud, Switzerland, in 1520. He was the lifelong friend of Cardinal Tournon, and accompanied the latter to Rome in 1549, remaining until 1560. During this time he made a critical study of the manuscripts of classical authors in the Vatican library. In 1561 he became professor of Greek and Latin in the University of Paris. He published editions of Cicero, Horace, Lucretius and Plautus, which are of great value to modern editors. He died in Paris, in 1572. His death is said to have been caused by a fit of apoplexy brought on by the sight of the horrors of the St. Bartholomew massacre.

LAMBINET, EMILE, a French landscape-painter, born in Versailles, France, Jan. 13, 1815; a pupil of Horace Vernet; was awarded medals in the salons of 1843, 1853 and 1857, and was given the decoration of the Legion of Honor in 1867. His paintings were remarkable for pearly gray tones, their atmospheres and a soft perspective. He died in Bougival, Jan. 1, 1878.

LAMELLIBRANCHIA. See MOLLUSCA, Vol. XVI, pp. 684-695.

LAMELLIROSTRES, an order of birds, arranged by Cuvier, including the "ducks" (*Anatidae*) and the flamingoes (*Phenicopteridae*). The name refers to the lamellæ in the beak or rostrum. The group is almost equivalent to the modern group *anseræ*, and without the flamingoes corresponds to the group *chenomorpha*.

LAMÉTHI, the name of three brothers who served in the American Revolutionary War, and afterward distinguished themselves as soldiers and statesmen during and after the French Revolution. ALEXANDRE THEODORE VICTOR; born in Paris, Oct. 28, 1760. He served in America on the staff of Count Rochambeau, and was made colonel in 1785. In 1789 he was elected to the Second Estate, the *Noblesse*, of the States General, but resigned to take a seat with the Third Estate. In the following year he was elected president of the National Assembly. His policy during the Revolution was the establishment of a constitutional monarchy, and he consequently found himself continually opposed by Mira-

beau, Robespierre and the Jacobins. When the war with Austria broke out he joined the army and served as field-marshal, but was accused by the National Assembly, obliged to flee, and finally was captured by the Austrians, who kept him prisoner for three years. After Napoleon came into power Lameth was prefect in several departments. Louis XVIII appointed him lieutenant-general in 1814, and afterward he was elected to the Chamber of Deputies, where he served four sessions as leader of the opposition. He wrote *History of the Constituent Assembly* (2 vols., 1828-29). He died in Paris, March 19, 1829.—CHARLES MALO FRANÇOIS, born in Paris, Oct. 5, 1757. He served in the American war on the staff of Rochambeau; was wounded at Yorktown; was promoted to rank of colonel. Returning to France, he was chosen to the National Assembly, and became its president in 1791. His policy was that of his brother Alexandre. He also joined the army, in 1792, served as field-marshal, and was obliged to flee from the army and take refuge at Hamburg. From 1809 to 1814 he served under Napoleon, attaining the rank of lieutenant-general. After Napoleon's fall he lived in retirement until 1829, when he was elected deputy to the Chamber. In the following year he took part in the revolution which deposed Charles X. He died in Paris, Dec. 28, 1832.—THEODORE, born in Paris, June 24, 1756. He also served in America; was deputy to the National Assembly in 1791-92, and was obliged to flee. He published his *Observations* in 1843. He died Oct. 19, 1854.

LAMIAN WAR. See GREECE, Vol. XI, p. 107.

LAMINARIA, a genus of the family *Laminariaceæ*, a group of the brown seaweeds. The leathery plant's body consists of a root-like lower part which serves to attach it, a stem-like part and a large terminal leaf-like expansion. In *L. digitata* the broad leaf is usually torn palmately by the waves into a number of strips; *L. saccharina* contains a large quantity of sugar, and is sometimes used in the preparation of a syrup. The latter species is also employed in surgery to distend apertures and passages, the cell-walls swelling up very much with the absorption of water. The large laminarias, where abundant, are also used in the production of iodine and soda.

LAMINITIS. See FOUNDER, in these Supplements.

LAMMAS DAY, the first day of August, the festival of the grain harvest, was originally one of the four great annual pagan festivals in ancient Britain. When Christianity was introduced into the country, this celebration, like many other heathen customs, was modified and adopted by the church. The day was celebrated by bringing a loaf, representing the first-fruits of the harvest, to the church, and hence was given the name *hlaf-mass*, which later was contracted to lammas. It was also customary for each family to give the Pope on Lammas day a penny, which was called Peter's penny. Lammas lands were lands tilled by individual occupiers until harvest or Lammas-time, and then thrown open as common pasture.

LAMMERMUIR HILLS. See HADDINGTON, Vol. XI, p. 361.

LAMNIDÆ. See ICHTHYOLOGY, Vol. XII, p. 685.

LAMONT, DANIEL SCOTT, an American statesman; born at Courtlandville, New York, Feb. 9, 1851. He was educated at McGranville Academy and Union College. Early in life he entered upon a newspaper career. In a short time he formed the acquaintance of political leaders of the Democratic party in New York. When President Cleveland entered upon his first term in 1885, Mr. Lamont became his private secretary, and exhibited tact and personal qualifications of a high order. In 1893 he accepted the portfolio of the war department in President Cleveland's second administration.



DANIEL SCOTT LAMONT.

LAMOTTE, ANTOINE HOUDART, a French critic and author; born in Paris, Jan. 17, 1672. He was educated at a Jesuit college; began his literary career as a playwright, and was elected to the Academy in 1710. Two years later he became blind. Lamotte published a poetical translation of the *Iliad*, in which he abridged and altered the original to suit his own taste, which caused a controversy with Mme. Dacier (q.v., Vol. VI, p. 759). He also published *L'Europe Gallante*, a ballet (1697); *Inès de Castro*, a tragedy (1723); and several volumes of essays, farces, etc. He died Dec. 26, 1731, in Paris.

LAMPASAS, a city and the capital of Lampasas County, central Texas, 63 miles N.N.W. of Austin, on the Gulf, Colorado and Santa Fé railroad, and on the Sulphur fork of the Lampasas River. It is the center of a large cotton and live-stock raising region; it has flour-mills, a creamery and ice factory. The sulphur springs here are visited by many invalids. Population 1890, 2,408; 1900, 2,107.

LAMPRIIDIUS, ÆLIUS, an ancient biographer. See AUGUSTAN HISTORY, Vol. III, p. 74.

LAMP-SHELL, a name sometimes applied to the brachiopod shells in general, but particularly to the shell of *Terebratulina* and its allies, because of the resemblance to an ancient lamp. Certain mollusk shells are used as lamps. In Shetland the shell of a species of *Fusus* is used for this purpose.

LANARK, a post village of Carroll County, northwestern Illinois, on the Chicago, Milwaukee and St. Paul railroad, 20 miles S.W. of Freeport. It contains a flour-mill, elevators and warehouses, a grain-separator factory, vinegar-works and a woolen factory. Population 1890, 1,295; 1900, 1,306.

LANCASTER, a village and the capital of Garrard County, central Kentucky, 32 miles S. of Lexington, on the Louisville and Nashville railroad. It is the commercial center of a grain and live-stock raising region. It has a tobacco factory, a wheat-fan factory and a high school. Population 1900, 1,640.

LANCASTER, a town and the capital of Coös County, northern New Hampshire, on the Connecti-

cut River, and on the Boston and Maine and the Maine Central railroads, 88 miles N. of Concord. It has a paper-mill and several starch and saw mills, hotels, churches, a public library and an academy, and is a popular summer resort. Population 1890, 5,373; 1900, 3,190.

LANCASTER, a city and the capital of Fairfield County, southern central Ohio, on the Cincinnati and Muskingum and the Columbus, Hocking Valley and Toledo railroads, on the Hocking River and the Hocking canal. It has a state reform farm for boys. It is supplied with natural gas from the vicinity. Population 1890, 7,775; 1900, 8,991. See LANCASTER, Vol. XIV, p. 255.

LANCASTER, a city and the capital of Lancaster County, southeastern Pennsylvania, near Conestoga Creek, on the Pennsylvania, the Philadelphia and Reading and the Cornwall railroads, 35 miles E.S.E. of Harrisburg. Its principal agricultural product is wheat, and tobacco is also raised in the vicinity. Limestone is quarried. Lancaster is an active manufacturing town. Over 500 establishments reported in 1890; their capital aggregated \$7,400,000, and their annual product averages \$10,300,000 in value. Among these establishments are several cotton-mills, breweries, tanneries, potteries, paper-mills and machine-shops, several iron-foundries and blast-furnaces. It is the oldest inland town in the state. Franklin and Marshal College (q.v., in these Supplements) is situated here. While the British were occupying Philadelphia in 1777, the Continental Congress met at Lancaster. Pop. 1890, 32,011; 1900, 41,459. See also LANCASTER, Vol. XIV, p. 255.

LANCASTER, a town and the capital of Lancaster County, central northern South Carolina, 50 miles N. of Columbia, on the Wateree River, and on the Cheraw and Chester and the Ohio River and Charleston railroads. It is in an agricultural region. Population 1890, 1,094; 1900, 1,477.

LANCASTER, a city and the capital of Grant County, southwestern Wisconsin, 20 miles N. of Dubuque, situated in a fine grain-producing and lead-ore region, on a branch of the Chicago and North-Western railroad. It contains a sash and door factory, machine-shops, carriage factories, a creamery, an excelsior factory and woolen and flour mills. Population 1890, 1,543; 1900, 2,403.

LANCASTER SOUND, a passage of the north polar regions connecting Baffin Bay with Barrow Strait, and extending from long. 78° to 88° W., between North Devon and Cockburn islands. It was discovered by Baffin in 1616.

LANCET-FISHES, the common name of fishes of the family *Acanthuridae*, which have lance-shaped spines on the tail. Sometimes the name is applied to certain fishes on account of the shape of their teeth. See ACANTHURIDÆ, in these Supplements.

LANCET-WINDOW. See ARCHITECTURE, Vol. II, p. 427.

LANCIANI, RODOLFO AMADEO, an Italian archæologist; born in Rome, Jan. 1, 1847. He was educated at the University of Rome; in 1877 received the appointment of director of excavations from the Italian government, and in the following year was made professor of Roman topography in the Uni-

versity of Rome. He published works on the archæology of Rome to the number of three hundred, among which are *Ancient Rome in the Light of Recent Discoveries* (1888); *Pagan and Christian Rome* (1892); and began a work, *Forma urbis Romæ*, in eight parts, the first of which was published in 1893.

LAND COMMISSION. See HOME RULE, in these Supplements.

LANDER, FREDERICK WILLIAM, an American engineer and soldier; born in Salem, Massachusetts, Dec. 17, 1821. He studied engineering at the military academy in Norwich, Vermont; practiced in Massachusetts, and afterward was employed by the government in making surveys in the West to determine the practicability of a transcontinental railroad. He also laid out the overland wagon route to the Pacific, in all making five transcontinental surveys. When the Civil War broke out in 1861, he served on the staff of General McClellan as engineer, and was promoted to the rank of brigadier-general of volunteers on May 17, 1861. He was wounded later in the year, but returned to active service in January, 1862. He died of congestion of the brain on the 2d of the following March.

LAND LEAGUE. See HOME RULE, in these Supplements.

LAND-RAIL OR CORN-CRAKE. See CRAKE, Vol. VI, p. 542; and RAIL, Vol. XX, p. 222.

LANDS, PUBLIC. See UNITED STATES, Vol. XXIII, pp. 822, 823.

LANDSCAPE-GARDENING, the art of giving a picturesque appearance to a plat of ground by modifying its physical features, its pools, streams, slopes, etc., or by constructing such artificially by making an artistic disposition upon it of trees, shrubs, lawns and garden-beds, and by introducing artificial structures, such as statues, monuments, bridges and roads, or otherwise changing the plat so that it will present a pleasing aspect. There can be no specific rules laid down for the arrangement of grounds, this depending almost entirely on the original condition of the piece of land in question, its use, the climate, and innumerable other conditions. The general rule usually observed in modern landscape-gardening, however, is, that art shall but assist nature, and itself be as unobtrusive as possible.

There has probably never existed a civilized nation which did not give some attention to beautifying its public and private grounds, but landscape-gardening, cannot be said to have become an art until the seventeenth century, when a great deal of attention was given by the Italian nobles to the improvement of the grounds around their villas, and a definite style of landscape-gardening, since called the Italian style, was developed. The chief characteristic of this style was its conventionality. Walks, trees, garden-plats, streams and terraces were all laid out with geometrical regularity. A good example of Italian gardening is the garden on the Isola Bella. A barren rock, in 1671, by Vitaliano Borromeo was converted into a paradise of fertility and luxury by bringing earth from the banks of the Lago Maggiore to one of the Borromeo Islands. (See BORROMEOAN ISLANDS, Vol. IV, p. 64.) He built ten terraces on arches, one above the other, to the top

of the island Isola Bella, on which the palace stands. These terraces he covered with fine exotic and native flowering plants, and with groves of bay, lemon and orange trees interspersing statuary in rich abundance. The Italian style of gardening made its way with some rapidity over Europe with the revival of art. But it was altered by the French and Dutch to accord better with the character of their climates and more level countries.

Gardening was brought to a high degree of perfection in Holland. The wealth acquired by the Dutch merchants and seafarers enabled them to indulge in fine country residences and luxurious gardens. They imported flowering plants, seeds and bulbs from the foreign countries they visited. The cultivated Dutch flowers, the tulip, anemone, hyacinth, narcissus, etc., are all Oriental, and came to them mostly from Constantinople in the sixteenth century. Bulbous flowers were cultivated extensively in Holland because the climate and soil of that country are singularly favorable for their growth. The Dutch and the French landscape-gardening are characterized by symmetry and an abundance of ornaments. But the gardens of Holland are more confined than the French, more often covered with frivolous ornaments, and generally intersected with still waters. As a specimen of the Dutch style of the seventeenth century, the gardens and palace at Loo during the time of William III may be taken.

FRENCH gardening revived with André Le Nôtre, who lived at the time of Louis XIV. He delighted in long clipped alleys, triumphal arches, richly decorated parterres, fountains and cascades, with grotesque ornaments, a profusion of statues and therms, and many deep grottos. All these wonders, springing up in a desert-like open country, dazzled and enchanted the beholders, and caused the king to make him director of the royal gardens, to create him a knight, and to commission him to improve also the gardens of the Tuileries, the Champs Elysées, Trianon, Neudon, St. Cloud, Chantilly and the celebrated Terrace of St. Germain. England, Sweden and all Europe adopted Le Nôtre's style. The gardens of Versailles are the grand effort of Le Nôtre and the model of excellence in the geometrical school of landscape-gardening.

The modern ENGLISH style of landscape-gardening was created by Bridgeman and Kent. William Kent vindicated the natural style against the artificial, and rejected entirely the mathematical symmetry of ground-plan then in vogue for laying out gardens. (See KENT, Vol. XIV, p. 40.) "Nature, not art, must be the model of the landscape-gardener," he said. The straight lines and stiff terraces of the ancient style were succeeded by flowing lines and wide, smooth lawns and slopes; the formal avenues and geometrical clumps in which trees had been arranged were succeeded by pleasing curves and an irregularity of grouping that relieved the eye and beautified the scene. The gardens and pleasure-grounds of Doublat, at Epinal, have the reputation of being the finest specimen of English gardening in France. Their great merits depend more on the natural beauties of the situation and of the sur-

rounding scenery than on the exercise of any style of art. They consist of a rocky hill rising abruptly from the town of Epinal to the height of four hundred feet, and stretching away to the east for a mile, in the form of a narrow ridge, gradually declining till it terminates in the valley of the Moselle.

The gardening of GERMANY, as compared with that of Great Britain, is, on the whole, inferior in the splendor of its productions; but it is nevertheless pursued in Germany with greater ardor in proportion to the wealth of the inhabitants. If there are no gardens in Germany in the natural style equal to the Parks of Great Britain, it is not for want of skill on the part of the Germans in laying them out tastefully, but attributable more to the severity of their winters, the scarcity of good gravel for walks, and the economy more generally practiced in their country. Yet there are good botanic and pleasure gardens at Munich, Carlsruhe, Berlin and elsewhere. The French style has prevailed in Germany from the earliest period. An excellent example is the park surrounding the palace at Carlsruhe. The whole place is a natural forest of pines and oaks, pierced with thirty-two avenues, radiating from the center of the grounds where stands the palace.

In AMERICA the art of landscape-gardening has as yet made rather slow progress. But the increase of wealth since the close of our Civil War, and the accompanying development of the artistic taste in painting, sculpture and allied branches, have given an impetus to the art which promises to bring its products very soon to the level with the best works in Europe. Some cemeteries, and the public parks of our cities, have up to this time been the main fields for its exercise. The climate and other conditions of America will modify the art to some extent. There is reason to expect, from the laying out of the Central Park, and of the several other parks in the cities of New York, Brooklyn, Philadelphia, Chicago, etc., that the natural English style, with its gentle flowing lines, will ultimately predominate over the stiff, geometrical Dutch and French styles of landscape-gardening in America.

LANDSEER, the name of a family of English artists. JOHN, an engraver; born in Lincoln in 1761; in 1807 elected associate engraver to the Royal Academy; in 1806 delivered lectures on *Engraving* before the Royal Institution and in 1823 on *Engraved Hieroglyphics*; author of *Sabaan Researches* (1823) and a *Catalogue of the Earliest Pictures in the National Gallery*. He engraved illustrations for Mackin's *Bible* (1793) and for Boyer's *History of England* (1793), and also made engravings after Turner, Rubens, Rembrandt and others. He died in London, Feb. 29, 1852.—CHARLES, son of the above, a painter; born in 1799; studied art under his father and Haydon and entered the schools of the Royal Academy at 16; elected associate of the Academy in 1837, academician in 1845, and in 1851 was appointed keeper. Among his paintings, which are largely on historical subjects, are *The Sacking of Basing House* (1836); *Cromwell at the House of Sir Walter Stewart* (1867); *Surrender of Arundel Castle* (1870); *A Langum Fishermans, Tenby* (1876). He died July 22, 1879. For his



more noted brother, SIR EDWIN, see LANDSEER, EDWIN, Vol. XIV, pp. 280, 281.—Another brother, THOMAS, an engraver, was born in London in 1795. He was elected associate of the Academy in 1868. He reproduced several of his brother Edwin's pictures; among them, *Doubtful Crumbs*, and also *The Horse Fair* and *Denizens of the Forest*, after Rosa Bonheur, which gave him a great reputation. He also did some original work in oils, *A Deluge of Rain*, *Lion-Hunting* and others. He was the author of the *Life of William Bewick* (1871). He died Jan. 20, 1880.

LANDSTURM. See GERMANY, Vol. X, p. 467; and ARMY, Vol. II, p. 604.

LAND SURVEYS IN THE UNITED STATES. See UNITED STATES, in these Supplements.

LANE, JAMES HENRY, an American politician; born in Lawrenceburg, Indiana, June 22, 1814. In 1840 he was admitted to the bar, and in 1846 enlisted in an Indiana regiment, of which he was made colonel. At the battle of Buena Vista he commanded a brigade. In 1848 he was elected lieutenant-governor of Indiana. From 1853 to 1855 he was a representative in Congress, having been chosen as a Democrat. There he voted for the repeal of the Missouri compromise. After moving to Kansas in 1855, he took an active part in the formation of the state government, and became a leader of the free state party. As such, he presided over both the Topeka and the Leavenworth constitutional conventions. In 1858 he shot a neighbor dead, in a quarrel about a well. He was tried for murder, but acquitted of the charge. When Kansas was admitted as a state of the Union, Lane was elected United States Senator. He served on the committees of Indian affairs and agriculture. During the Civil War he was for a time brigadier-general of volunteers. In 1865 he was re-elected for the United States Senate, but in the midsummer of the following year, when on his way home, he had an attack of paralysis, affecting his sanity, and committed suicide at Leavenworth, July 1, 1866.

LANE, JOSEPH, an American soldier and statesman; born in Buncombe County, North Carolina, Dec. 14, 1801. He moved to Warwick County, Indiana, in 1816, and became a clerk in a mercantile house. In 1822 he was elected to the state legislature, which office he held until 1846, when he enlisted in a regiment of volunteers. He was commissioned colonel and afterward brigadier, and served throughout the Mexican War, gaining the brevet of major-general. He was appointed governor of Oregon in 1848, and was its delegate to Congress in 1851-57. When Oregon was admitted in 1859 he was elected to the Senate, serving until 1861. In 1860 he was nominated for Vice-President on the ticket with Breckinridge, and after his defeat took no more part in politics, and passed the rest of his life in obscurity and poverty, dying April 19, 1881, in Oregon.

LANE-POOLE, STANLEY, an English Orientalist and author; born in London, Dec. 18, 1854. He was educated under the direction of his great-uncle, E. W. LANE, the Orientalist (q.v., Vol.

XIV, p. 282), and graduated at Corpus Christi, Oxford, in 1878. His first important work was a *Catalogue of the Oriental Coins in the British Museum* (8 vols., 1875-83), to which he added a *Catalogue of Indian Coins* (3 vols., 1884-92); *Additions to the Oriental Collection* (2 vols., 1890); and a *Catalogue of Arabic Glass Weights* (1891). After the death of his great-uncle, Lane-Poole took up his *Arabic Lexicon*, and brought out volumes 6, 7 and 8 (1877-93). He also wrote a *Life of E. W. Lane* (1877). Among other works he published *Life of Stratford Canning* (1888); *Social Life in Egypt* (1883); and *The Life of Sir Harry Parkes*, with F. V. Dickens (1894), and contributed to this ENCYCLOPEDIA the article on WYCLIFFE. In all, he published about 60 volumes.

LANESBORO, a town of Fillmore County, southeastern Minnesota, 28 miles S.W. of Winona, on the south branch of the Root River, and on the Chicago, Milwaukee and St. Paul railroad. It contains a newspaper-office, churches, a bank, a high school and a flour-mill, oatmeal-mill, creamery, flax-fiber mill and wagon-works. Population 1900, 1,102.

LANFRANCO OR LANFRANC, GIOVANNI, an Italian artist; born in Parma in 1581. He studied under the Carracci, whose work his earlier pictures resemble strongly. He worked in Rome for the Farnese and Borghese families, and after the death of the Carracci, returned to his native city, whereupon his work took on a more individual style. Among his best-known paintings are *St. Andrea Avellino* at Rome; fresco paintings on the cupola of St. Andrea della Valle in Rome; on the cupola of the Church of Jesus at Rome; and the *Dead Christ* at Bologna. He died in Rome in 1647.

LANG, ANDREW, a British writer; born at Selkirk, Scotland, March 31, 1844, and educated

at Edinburgh Academy, St. Andrews University and Balliol College, Oxford, where he graduated first-class in classics. In 1868 he was elected fellow of Merton College, Oxford, and in 1888 was appointed Gifford lecturer on natural religion at St. Andrew's University. His *Ballades in Blue China* (1881) brought him into prominent notice, and his subsequent works, especially *Helen of Troy*, *Rhymes à la Mode*, and *Custom, Ritual and Myth*, increased his reputation. He was joint translator with Professor Butcher of the *Odyssey*, and with Mr. Myers and Mr. Leaf of the *Iliad*. His recent works include *The Gold of Fairmile*, *Lost Leaders* and *Prince Prigio*. He also edited the *Blue Fairy-Tale Book* and the *Red Fairy-Tale Book*. In 1890 he wrote, in collaboration with Rider Haggard, *The World's Desire*. In 1891 he wrote *Essays in Little*; in 1894 *A History of St. Andrews* and *Ban et Arrière Ban*, a



ANDREW LANG.

volume of verse; in 1895 *A Monk of Fife, My Own Fairy-Book*, and edited *The Red True Story-Book*; and in 1898 published *The Making of Religion*. He also annotated the Border Edition of the *Haverley Novels*, and wrote the department, *At the Sign of the Ship*, in *Longmans' Magazine*.

LANGDON, JOHN, an American statesman; born at Portsmouth, New Hampshire, June 25, 1741. He engaged in mercantile business in his native city till 1774, when he secured the ordnance stores of Fort William and Mary in Portsmouth harbor for the colonists. In 1775 he was elected to the Continental Congress, and in 1776 he became a navy agent. In 1777, while he was speaker of the New Hampshire assembly, and means were needed for equipping General Stark's brigade, Langdon gave all his money, pledged his silver plate and subscribed the proceeds for that purpose. He commanded a company in the brigade and took part in the battles of Bennington and Stillwater. In 1779 he presided in the New Hampshire convention, and in 1787 he was a delegate to the convention at Philadelphia which framed the Constitution of the United States. In 1788 he became governor of New Hampshire and in the next year he was elected United States Senator, holding office till 1801, when he was chosen president of the Senate. From 1805 till 1812, with the exception of one year, he was governor of New Hampshire. He died in Portsmouth, Sept. 18, 1819.

LANGENDIJK, PIETER, a Dutch poet and playwright; born at Haarlem, July 25, 1683. His father died while the boy was a child, and his mother moved to The Hague, and supported herself and him by keeping a shop. He became a designer of damask, moved to Amsterdam and went to work at this occupation in a linen factory. Here appeared his first comedies: *Don Quixote* (1711); *The Braggart* (1712); and *The Mutual Marriage Deception* (1712). In 1715 he published *Krelis Louven* and the *Mathematicians*, and in 1720 *Arlequijn Actionist*. In 1722 he returned to Haarlem, and for about twenty years nothing appeared from his pen. Among his later plays are *Nautippe*, which, it is said, was suggested by his own unfortunate matrimonial venture; *Papirius*; and *A Mirror of Our Merchants*, which was left incomplete. Although, to a certain extent, under the domination of French taste, Langendijk's comedies possess considerable originality and vigor, and some of them are acted still on the Dutch stage. His collected works were published in 1760. He died in 1756.

LANGEVIN, SIR HECTOR LOUIS, a Canadian statesman; born in Quebec, Aug. 26, 1826. After studying law, he was admitted to the Canadian bar in 1850, and became queen's counsel in 1864. For one term he was mayor of Quebec, but for several terms he served as representative in the Dominion Parliament. From 1864 till 1865 he was solicitor-general for Lower Canada, and from 1865 till 1867 he was Postmaster-General. After the union of the provinces he became Secretary of State for Canada, which portfolio he retained

until he was appointed Minister of Public Works in 1869. In 1878 he became Postmaster-General again and in 1879 again Minister of Public Works. He was a Conservative in politics. In 1891 he was forced to give up his office on account of frauds discovered in his department, although his own honesty was not doubted. He wrote *Le Canada, Ses Institutions, and Droit Administratif, ou Manuel des Paroisses et Fabriques*; also *Report on British Columbia* (1872), having been appointed by the government to visit the country and acquire information concerning it.

LANGHAM, SIMON, an English ecclesiastic; born at Langham, in Rutlandshire, about 1310. He entered the clergy in 1335; became abbot of Westminster in 1349; bishop of Ely in 1362; was Chancellor of England (1363-66); archbishop of Canterbury in 1367. He resigned the archbishopric in the following year, and went to the papal court at Avignon. He was made cardinal bishop in 1373, and again appointed to the see of Canterbury; but his appointment was not confirmed by the pope. He is best known for his removal, while primate, of Wycliffe from the wardenship of Canterbury Hall, Oxford. See WYCLIFFE, Vol. XXIV, p. 708. He died July 22, 1376.

LANGLES, LOUIS MATHIEU, a French Orientalist; born at Perenne, Haute-Loire, Aug. 23, 1763. He studied Oriental languages, and in 1795 was chosen professor of Persian in the School of Oriental Languages, founded in Paris in that year by the French government. He translated into French *The Political and Military Institutions of Tamerlane, Written by Himself, in Mongol* (1787); edited Amyot's *Manchu-French Dictionary* (1789-90); and was the founder of the Geographical Society of Paris. He died in Paris, Jan. 28, 1824.

LANGLEY, SAMUEL PIERPONT, an American astronomer and physicist; born in Roxbury, Massachusetts, Aug. 22, 1834. He was educated at the Boston Latin School, and became a civil engineer, but spent a great deal of his time in the study of astronomy. In 1865 he was appointed assistant at the Harvard Observatory, and shortly afterward professor of mathematics in the United States Naval Academy at Annapolis. In 1867 he received the appointment of professor of astronomy at the Western University of Pennsylvania, with charge of the observatory at Allegheny City. At this time the total equipment of the observatory consisted of a 13-inch equatorial telescope, and Professor Langley, in order to raise funds for procuring more apparatus, originated the system, still in vogue, of supplying railroads with electric time-signals. Since then the scheme has been taken up by many of the observatories of the country. In 1869 and 1870 he accompanied the parties sent by the United States government to Oakland, Kentucky, and to Xeres, Spain, respectively, to observe the total eclipses which occurred in those years. In the latter year he began the study of solar phenomena, in which subject he became a recognized authority, and proved, among

other theories, that the effect of a sun-spot on the temperature of the terrestrial atmosphere is appreciable. Finding the thermopile, in the course of his investigations, not sensitive enough for his purpose, Professor Langley invented the bolometer, by which he was able to measure the slightest changes in temperature. In 1878 he observed a total eclipse of the sun from Pike's Peak, Colorado, and spent the winter of 1878-79 in the study of that body from Mount Ætna, Sicily. In 1881 he organized a party under the auspices of the United States Signal Service to ascend Mount Whitney, and in 1885 gave the results of his investigations in the absorption of solar heat by the earth's atmosphere, before the Royal Society in London. Two years later he was chosen secretary of the Smithsonian Institution. Among Professor Langley's honors may be mentioned the Rumford medal from the Royal Society of London in 1887; membership in the National Academy of Sciences; in 1886 the presidency of the American Association for the Advancement of Science, and memberships in other learned societies, domestic and foreign. He also interested himself in the subject of *aéronautics* (q.v., in these Supplements), and devised a flying-machine. Among his published works are *The New Astronomy*, which first appeared in the *Century Magazine* (1884-86); *Experiments in Aërodynamics* (1891); and *The Internal Work of the Wind* (1894).

LANGLOIS, VICTOR, a French Orientalist; born at Dieppe, March 20, 1829. He studied Oriental languages and traveled in Asia in 1852-53, as the result of which he published *Travels in Cilicia and in the Mountains of Taurus*. His other works are *Mount Athos and Its Monasteries* (1867), and *Collections of Ancient and Modern Historians of Armenia*, which was left incomplete at the time of his death, May 14, 1869.

LANGSTON, JOHN MERCER, an American lawyer and educator; born in Louisa County, Virginia, Dec. 14, 1829. By birth he was a mulatto slave, but was emancipated in childhood. He studied theology at Oberlin, graduating in 1853, and afterward studied law. From 1854 till 1869 he practiced law in Ohio. In 1869 he was made professor of law in Howard University, Washington. In 1873 he became dean of the faculty of the law department of the university. From 1875 to 1885 Langston was United States minister and consul-general in Haiti. After his return he was appointed president of the normal and collegiate institute in Petersburg. He wrote a volume of selected addresses, entitled *Freedom and Citizenship* (1883), and published many papers on political, biographical, literary and scientific subjects.

LANGTRY, EMELIE CHARLOTTE LILLIE, an English actress, the daughter of the Rev. W. C. le Breton, dean of Jersey; born at St. Hélier's, on the island of Jersey, in 1852. She was celebrated for her beauty, being known as the "Jersey Lily," and in 1874 was married to Edward Langtry of Belfast. Her husband's means having become diminished, she determined to go on the stage,

and made her first appearance, Dec. 15, 1881, at the Haymarket Theatre, London, in *She Stoops to Conquer*. After that she continued acting in London in different plays, and in 1882, 1886 and 1895 made tours in America. Among her rôles are Rosalind in *As You Like It*, Juliana in the *Honeymoon*, and Lady Teazle in *The School for Scandal*. Her success as an actress was perhaps not due so much to her histrionic powers as to the curiosity of her audiences to see her.

LANIER, SIDNEY, an American poet; was born Feb. 3, 1842, in Macon, Georgia. He was the son of a lawyer, and was graduated at Oglethorpe College, Midway, in his native state, when 18 years of age. Enlisting in the Confederate army upon the capture of Fort Sumter, he served in the battles about Richmond, in the signal service at Petersburg, in North Carolina, and in 1864 was captured while in command of a blockade-runner, suffering an imprisonment of five months at Point Lookout, Florida. At the close of the war he was, for a time, a clerk in Montgomery, Alabama; in 1867 he taught a Southern academy; the next year he joined his father, at Macon, in the practice of law. He composed the cantata sung in 1876 at the opening of the Centennial Exhibition in Philadelphia; the next year he was lecturing on English literature in Baltimore; in 1879 he was appointed lecturer on this subject in the Johns Hopkins University. Two years later, while camping in western North Carolina, he died of consumption, Sept. 7, 1881. The hard circumstances of wretched health and penury were borne by Lanier with pathetic patience, and a sensitive disposition, with the fastidious taste of high ideals, repressed his spontaneity. His first love was music, to which he thought himself more of a devotee than to verse. In *Science of English Verse* (1880) he published his theory of versification and created the expectation that he might produce a new type of song. His poems were collected after his death by his wife, to which Dr. W. H. Ward prefixed a discerning memorial. They are full of changing color, high ethical thought, melody, finely wrought work, but too passionless. His other books are *Florida* (1876); *The Boy's Froissart* (1878); *The Boy's King Arthur* (1880); and two posthumous books, *The Boy's Percy* and a critical work on *The English Novel and Its Development* (1881).



SIDNEY LANIER.

LANKESTER, EDWIN, an English physician; born at Melton, Leicestershire, April 23, 1814. After studying medicine at University College, London, and at Heidelberg, where he graduated in 1839, he became lecturer in St. George's School of Medicine; in 1850 professor at New College, London; and in 1866 editor of *The Journal of Social Science*. He published *Vegetable Physiology*;

*School Manual of Health*; and other medical works for popular use. He died Oct. 30, 1874.

LANKESTER, EDWIN RAY, an English zoölogist, son of Edwin Lankester; born in London, May 15, 1847. After being educated at Christ Church, Oxford, he became lecturer in Exeter College, Oxford, in 1872, and professor of zoölogy and comparative anatomy in University College, London, in 1874. Besides his work as editor of the *Quarterly Journal of Microscopical Science* and as secretary of the British Association for the Advancement of Science, Professor Lankester published *Fossil Fishes of the Old Red Sandstone*; *Comparative Longevity*; and *Developmental History of the Mollusca* (1875), besides contributing the articles on MOLLUSCA, PROTOZOA, VERTEBRATA and ZOÖLOGY, in this ENCYCLOPÆDIA. He was prominent in the defense of vivisection.

LANMAN, CHARLES, an American author; born in Monroe Michigan, June 14, 1819. For ten years he held a clerkship in a New York mercantile house, and in 1845 became editor of the Monroe (Michigan) *Gazette*. In 1846 was on the staff of the *Cincinnati Chronicle*; in 1847 on the New York *Express*. Two years later he was appointed librarian of the War Department, and in 1850 became private secretary of Daniel Webster; in 1866 librarian of Congress, and from 1871 to 1882 secretary of the Japanese legation. During this time and until his death he devoted much labor to literary work. Among his books are *Essays for Summer Hours* (1842); *A Summer in the Wilderness* (1847); *A Tour to the River Saguenay* (1848), in which he made this region known to the general public; *Private Life of Daniel Webster* (1852); *The Japanese in America* (1872); *Hazardous Personalities* (1886); and a *Dictionary of Congress*, which has gone through several editions. Mr. Lanman was also an artist, being elected associate of the National Academy in 1846. He exhibited *Brookside and Homestead* (1881), *Frontier Home* (1884), and other pictures. He died in Washington, District of Columbia, March 4, 1895.

LANMAN, CHARLES ROCKWELL, an American philologist, born at Norwich Town, Connecticut, July 8, 1850; was educated at Yale, graduating in 1871, and afterward taking a post-graduate course under Professor Whitney; studied in Berlin, Tübingen and Leipsic; appointed instructor at Johns Hopkins, and in 1880 professor of Sanskrit at Harvard. He published *On Noun Inflection in the Vedas* (1880); *Sanskrit Reader* (1881); and, as secretary of the American Philological Society, edited its *Proceedings and Transactions* (1879-81).

LANPO OR DIHONG, a river of Tibet. See TIBET, Vol. XXIII, p. 341; and DIHONG, in these Supplements.

LANSDOWNE, HENRY CHARLES KEITH PETTY-FITZMAURICE, MARQUIS OF, the fifth of the title, an English statesman and diplomat; born Jan 14, 1845; educated at Eton and Balliol College, Oxford; succeeded his father in the marquise (1866); held the offices of Lord of the Treasury (1868-72); Under-Secretary of War (1872-74), Under-Secretary for India (1880); Governor-General of Canada

(1883-88); Governor-General of India (1888-93); and Secretary of War (1895).

LANSDOWNE, HENRY PETTY-FITZMAURICE. See PITT, Vol. XIX, p. 148, note.

L'ANSE, a village, and the capital of Boraga County, northwestern Michigan, at the head of the Keweenaw Bay, on the Duluth, South Shore and Atlantic railroad. It has quarries of slate and brown sandstone, beside plumbago deposits, and ships iron-ore, fish and lumber. Population 1895, 957.

LANSING, a city of Allamakee County, north-eastern Iowa, on the Mississippi River, 81 miles N. of Dubuque, on the Chicago, Milwaukee and St. Paul railroad. It has a furniture factory, wagon-works, flour-mill and implement factory. It is the trade center of a large grain-raising region. Population 1900, 1,438.

LANSING, the capital of Michigan, situated in the southern part of the state, on the Detroit, Lansing and Northern, the Michigan Central, the Chicago and Grand Trunk and the Lake Shore and Michigan Southern railroads. The State Agricultural College had, in 1896, 31 instructors, 402 pupils, and has 20,000 volumes in its library. It is in a fertile and populous region, with abundant timber and coal. Its manufactures include agricultural implements, stoves, sleds, carriages, wagons, wheelbarrows, pressed stone, condensed milk, flour, knit-goods, machinery and steam-engines. It is provided with public parks, electric lights and street-railways, and with water-works owned by the city. Population 1890, 13,102; 1900, 16,485. See also LANSING, Vol. XIV, p. 290.

LANSINGBURG, a village in Rensselaer County, central eastern New York. (See LANSINGBURG, Vol. XIV, p. 291). It is connected with Troy by an electric railway, and with Waterford and Cohoes by bridges across the Hudson. Collars, cuffs and shirts are the most important products of the manufactories here next to those mentioned in the article to which reference is made. Population 1890, 10,550; 1900, 12,595.

LANTANA, a tropical or subtropical genus of mostly shrubby plants, of the family *Verbenacea*, with fragrant leaves and flowers. The species are extensively cultivated and much crossed, some of the more common ones being *L. Camara*, from tropical America, with deep yellow flowers; *L. mixta*, from Brazil, with flowers white at first, changing to yellow and red; *L. nivea*, from Brazil, with unchanging white flowers; *L. involucrata*, of the West Indies, with lilac purple flowers; and *L. Sellowiana* of Brazil, with reddish-purple flowers.

LANTERN. See ARCHITECTURE, Vol. II, p. 467.

LANZAROTE. See CANARY ISLANDS, Vol. IV, p. 800.

LAOMEDON, a legendary king of Troy. See TROAD, Vol. XXIII, p. 583.

LA PAZ, the principal town and seaport, and the capital of Baja (or Lower) California, on La Paz Bay. It is situated in a small but verdant well irrigated plain, between the bay and the

mountains, in lat. 24° 10' N. It is the seat of trade for the mines of Triunfo, 40 miles to the south. There are important pearl-fisheries in the bay. Population, 6,000.

LAPEER, a city and the capital of Lapeer County, southeastern Michigan, 64 miles N.N.W. of Detroit. It has large flour and lumber mills, carriage factories, foundries and machine-shops, and is a shipping-point for shingles and pine lumber. Population 1900, 3,297.

LAPHAM, INCREASE ALLEN, an American naturalist, and founder of the United States Weather Bureau; born in Palmyra, New York, March 7, 1811. He was first a stone-cutter, then worked on several canals as a civil engineer. In 1836 he settled at Milwaukee, Wisconsin, where he was made register of claims. He prepared an herbarium of some 8,000 specimens of plants found in Wisconsin, and a catalogue of shells. He studied especially the grasses of Wisconsin; then the geology of that state, and lastly the fluctuations in the level of Lake Michigan, in which he detected the influence of "a slight lunar tide." In 1873 he became state geologist. Besides numerous contributions to scientific periodicals he was the author of *Wisconsin: Its Geography, Topography, History, Geology and Mineralogy*; a *Geological Map of Wisconsin*; and *Antiquities of Wisconsin*. The last-named work was published by the Smithsonian Institution in 1855. For some time Dr. Lapham had been interested in the study of meteorology, and with the aid of Dr. Asa Horr of Dubuque, Iowa, and of Professor Abbé of Cincinnati, had been able to predict storms several hours before they reached Milwaukee. In 1869 he sent a memorial to Congress suggesting the practicability and the value of predicting storms on the Great Lakes by use of the telegraph. The result was the passage of a bill, Feb. 9, 1870, authorizing the Secretary of War to institute a system of signals on the lakes and sea-coast, which finally developed into the Weather Bureau. At first, stations were started in 24 places, the results of observation being telegraphed to Washington. Dr. Lapham was offered a position at the head of the bureau, but declined because his Quaker principles would not allow him to enter a military service. He acted, however, as assistant in Chicago for some time. He died at Oconomowoc, Wisconsin, Sept. 14, 1875.

LA PLATA, the capital of the Argentine province of Buenos Ayres, founded in 1884, after Buenos Ayres City, from which it is 24 miles to the S.E., had been made the federal capital. The new city was rapidly built, with wide streets that are now mostly paved; the central portion is lighted with electric light, the rest with kerosene lamps. The only buildings of note are the handsome capitol and other offices of the government, an observatory, several chapels and a fine railway station. The city has a college, and several miles away, a hospital and an asylum for the insane. Among the manufactories already established is one of cotton and woolen tissues. A canal nearly 5 miles long and deep enough for

vessels of 21 feet draft connects a harbor which has been constructed at La Plata with a large outer harbor at Ensenada, on the La Plata River. See also PLATE, THE RIVER, Vol. XIX, pp. 187-189. Population 1895, 45,410.

LA PLATA, UNITED PROVINCE OF See ARGENTINE REPUBLIC, Vol. II, p. 487.

LAPORTE, a city of northwestern Indiana, and the capital of LaPorte County. It is situated on the Chicago and West Michigan, the Lake Erie and Western, and the Lake Shore and Michigan Southern railroads. The city has numerous educational and charitable institutions, a public library, electric lights and Holly water-works. Population 1900, 7,113. See also LA PORTE, Vol. XIV, p. 308.

LAPORTE CITY, a town of Black Hawk County, northeastern central Iowa, on Wolf Creek, 1 mile from Cedar River and 16 miles S.E. of Waterloo, on the Burlington, Cedar Rapids and Northern railroad. Flour, wagons, carriages and other articles are manufactured here, and grain and other farm produce is shipped. Population 1890, 1,052; 1900, 1,419.

LARA, a state of VENEZUELA; q.v., Vol. XXIV, p. 140.

LARAMIE, a city and the capital of Albany County, southeastern Wyoming, situated in the midst of Laramie Plains, 7,122 feet above sea-level, and 57 miles by the Union Pacific railroad from Cheyenne. From the Black Hills a number of irrigation canals run down through the city, supplying it with cold clear water. Situated here are the State University, State Agricultural College, state penitentiary and the state fish-hatchery. It has a public library and railroad machine-shops, rolling-mills, flour-mills, soda-reduction plant, stone-quarries and glass and soap factories. The first female jury ever impaneled served here. Population 1890, 6,388; 1900, 8,207.

LARAMIE, a river which rises in the Medicine Bow Range, Larimer County, northern Colorado, flows generally northeast through southeastern Wyoming and enters the North Fork of the Platte at Fort Laramie, after a course of about two hundred miles. It is much used for floating lumber from the mountains.

LARAMIE MOUNTAINS, a range of Colorado and Wyoming, but mostly in Wyoming. These mountains extend southward in a curve, bounding Laramie Plains on the northeast and east. Laramie Peak, in Albany County, Wyoming, is their highest point. Their composition is a nucleus of red syenite, with margins of fossiliferous formation, Carboniferous, Triassic, Jurassic, Cretaceous and occasional lignite Tertiary.

LARCENY. See THEFT, Vol. XXIII, p. 232.

LARCOM, LUCY, an American poetess; born in Beverly, Massachusetts, in 1826. When she was 12 years old her father died, and her mother established a factory boarding-house in Lowell. After spending about three years at school she became a factory-hand in a cotton-mill. During that time she contributed to the *Lowell Offering* a series of parables. At

the age of 20 she went to Illinois, where for three years she studied in Monticello Female Seminary.



LUCY LARCOM.

On her return to Massachusetts she was employed six years in the Norton Female Seminary, and later taught classes in the Boston schools. An acquaintance with the poet Whittier ripened into friendship which has become famous in literary circles. She was for a time editor of *Our Young Folks*, a Boston magazine. Her publications are *Ships in the Mist* (Boston, 1859); *Poems* (1868); *An Idyl of Work* (1875); *Childhood Songs* (1877); *Wild Roses of Cape Ann, and Other Poems* (1880). She died in Boston, Mass., April 15, 1893.

LAREDO, a city and the capital of Webb County, southern Texas, on the Rio Grande, 78 miles W.S.W. of San Diego, on the Mexican National and the International and Great Northern railroads. It is connected with Nuevo Laredo, on the opposite bank of the river, by two steel bridges. It is in the Rio Grande coal region, and has an important trade with Mexico, its exports averaging \$12,000,000 annually; it is the shipping-point of the largest wool region of the state, and ships large quantities of brick to New Mexico and southwestern Texas. Iron, lead, zinc and copper are also products of the vicinity. Population 1890, 11,310; 1900, 13,420.

LARID.E. See GULL, Vol. XI, p. 274.

LARIVEY, PIERRE. See DRAMA, Vol. VII, p. 423.

LARKSPUR (*Delphinium*). See HORTICULTURE, Vol. XII, pp. 249, 251, 255.

LARNAKA. See CYPRUS, Vol. VI, p. 748.

LARNED, a city and the capital of Pawnee County, southwestern central Kansas, on the Arkansas and Pawnee rivers, 20 miles above Great Bend, and on the Atchison, Topeka and Santa Fé railroad. It is surrounded by a fertile farming and stock-raising region, where building-stone, potter's-clay and ochre are found. It has a foundry, machine-shops and flour-mills. Population 1890, 1,861; 1900, 1,583.

LA ROCHE or LAROCHE, MARIA SOPHIE GUTERMAN, a German authoress; born at Kaufbeuren, Bavaria, Dec. 6, 1731. She wrote novels somewhat after the style of the English novelist Richardson. Among them are *Fraülein Sternheim*; *Melusinens Sommerlieder*; and *Rosalien's Briefe*. She is better known, however, on account of her connection with the German literary men of the day. Wieland is said to have fallen in love with her, and Goethe with her daughter, Maximilliane. After her marriage with La Roche, her house at Ehrenbreitstein became a favorite resort for literary men and women. Her daughter was the mother of Bettina von Arnim and

Clemens Brentano. She died at Offenbach, Hesse, Feb. 18, 1807.

LA ROCHEFOUCAULD-LIANCOURT, FRANÇOIS ALEXANDRE FRÉDÉRIC DE, a French philanthropist; born Jan. 11, 1747, in Paris. He was president of the National Assembly in 1789; was forced to leave the country in 1792, and lived in England and America until 1799. He was created peer in 1814. Among other philanthropic institutions, he established a school for the education of poor soldiers' children on his estate at Liancourt, which developed into the School of Arts and Trades of Châlons. He also introduced vaccination into France, and established the first savings bank in the country. He was the author of *Travels in the United States of America* (1798). He died March 27, 1827.

LAROMIGUIÈRE, PIERRE, a French philosopher; born in Guienne, Nov. 3, 1756. He was elected professor of philosophy in the College of Toulouse in 1784; professor in the Lycée of Louis XIV in 1795; at the University of Paris in 1811. His principal work is *Lessons in Philosophy* (1815-18). He accepted and taught, with some modifications, the philosophy of Locke and Condillac, leaving "a fair and pure renown." He died in Paris, Aug. 12, 1837.

LAROUSSE, PIERRE, a French publisher; born at Toucy, in Yonne, Oct. 23, 1817. After teaching for some years, he commenced, in 1851, the publication of school books, many of which he prepared himself. The principal work he undertook was the *Dictionnaire Universel du XIXe Siècle*, for which he commenced to engage contributors in 1863. The exhaustive labor connected with the undertaking hastened his death, which occurred when the dictionary was only half finished. It was completed in sixteen volumes by his widow, and proved a great success. He died Jan. 3, 1875.

LARRA, JOSÉ MARIANO, pseudonym "Figaro." See SPAIN, Vol. XXII, p. 361.

LARVA. See MORPHOLOGY, Vol. XVI, p. 837.

LARVALIA. See VERTEBRATA, Vol. XXIV, p. 186.

LARYNGITIS. See THROAT DISEASES, Vol. XXIII, pp. 319, 320.

LARYNGOSCOPE. See VOICE, Vol. XXIV, p. 276.

LASALLE, a city of Lasalle County, northeastern Illinois. It is the western terminus of the Illinois canal, which extends to Chicago, and is on the Illinois Central, the Chicago, Rock Island and Pacific, the Chicago, Burlington and Quincy, and the Lasalle and Bureau County railroads. Lasalle is engaged in the manufacture of glass and hydraulic cement, in the mining of bituminous coal, and in the smelting and rolling of zinc. The town is lighted with gas and electricity, and has electric railroads. Population 1900, 10,446. See also LA SALLE, Vol. XIV, p. 316.

LAS GUASIMAS. See GUASIMAS, LAS, in these Supplements.

LASKER, EDUARD, a German statesman; born at Jarocin, Posen, Oct. 14, 1829, of Hebrew parentage. After studying law at Berlin and in England, he became, in 1856, an assessor in the city court of Berlin. In the Prussian Chamber of Deputies, to

which he was elected in 1865, he assisted in founding the National Liberal party, and aided Bismarck in measures tending to the unification of Germany, but in the Reichstag, of which he became a member in 1865, he opposed Bismarck's measures in regard to government control of the railroads, and showed himself a determined advocate of free trade when the Chancellor adopted the protective policy. The struggle for leadership between Lasker and Bismarck became bitter and personal, and in 1880 Lasker led the secession from the National Liberal party. In 1883, Lasker made a visit to his brother in Texas, and while returning, he died suddenly in New York City, Jan. 5, 1884. The United States House of Representatives passed resolutions of regard and transmitted them to Germany by the United States government, but Prince Bismarck returned them, as containing improper reflections on the internal affairs of the German Empire. Lasker was the author of *On the Constitutional History of Prussia* (1875) and the *Means and Aims of the Development of Culture* (1881). His *Life* was written by A. Wolff (1884).

LAS PALMAS. See CANARY ISLANDS, Vol. IV, p. 799.

LASSEN PEAK. See CALIFORNIA, Vol. IV, p. 700.

LAS VEGAS, a city and the capital of San Miguel County, northeastern New Mexico, on the Pecos River, 45 miles E. of Santa Fé, and on the Atchison, Topeka and Santa Fé railroad. It is situated in a grazing and mining region, and has large wool interests. It has gas and electric lights, an electric street-railway and a state normal school. The Las Vegas Hot Springs, northwest of this village at the mouth of the picturesque Gallinas Cañon, are famed for their curative powers in various complaints. They are 22 in number, and average 130° F. in temperature. They resemble the Carlsbad water, but are more dilute, the principal constituents being carbonate and sulphate of sodium. Population 1890, 2,385; 1900, 3,552.

LATERAL—LINE ORGAN. See SENSE-ORGANS, in these Supplements.

LATERAN, a Roman palace. The name is also given to a church, St. John Lateran, which was built by Constantine in the palace of the same name. The original basilica was destroyed by an earthquake in A.D. 896. It was rebuilt, but was destroyed by fire in 1308 and again in 1360, and has been many times remodeled. (See also ROME, Vol. XX, p. 835).

LATERAN COUNCILS, ecclesiastical councils, so called because held in the Church of St. John Lateran (San Giovanni, in Laterano). See COUNCIL, Vol. VI, pp. 511, 512.

LATES, a genus of perch-like fishes, inhabiting the rivers Nile and Ganges. *L. niloticus*, or Nile perch, attains a length of three feet, and is the largest fish in the river. The Ganges species is *L. nobilis*. Both are excellent food-fishes.

LATEX. See *Lactiferous Vessels*, under BOTANY, Vol. IV, p. 87.

LATHAM, ROBERT GORDON, an English philologist and ethnologist; born at Billingsborough, Lincolnshire, March 24, 1812. He was educated at

Eton and Cambridge, studied medicine and became assistant physician in the Middlesex Hospital. Then he traveled in Norway and studied the Scandinavian idioms. In 1841 he was made professor of English literature in University College, London. He published numerous works on philology and ethnology; among them, *Norway and the Norwegians* (1840); *Treatise on the English Language* (1841); *Natural History of the Varieties of Man* (1850); *Man and His Migrations* (1851); *Descriptive Ethnology* (1851); *The Nationalities of Europe* (1863); and a series of English grammars. Mr. Latham was the originator of the theory that the first home of the Aryan race was in Europe, not Asia. He died March 9, 1888.

LATHAM, JOHN, an English ornithologist; born at Eltham, near London, June 27, 1740. He studied medicine, and began to practice at Dartford. He was one of the founders of the Linnæan Society and of the Royal Society. See ORNITHOLOGY, Vol. XVIII, p. 6. He died Feb. 4, 1837.

LATHES, RECENT. See MACHINE-TOOLS, in these Supplements.

LATHROP, GEORGE PARSONS, an American author and editor; born in Honolulu, Aug. 25, 1851;

was educated in Germany, and married, in 1871, Rose Hawthorne, the second daughter of Nathaniel Hawthorne. Mr. Lathrop was assistant editor of the *Atlantic Monthly* from 1875 to 1877, and afterward edited the *Boston Courier* from 1877 to 1879. He wrote *Rose and Rooftree*, poems (1875); *Afterglow*, a novel, and *A Study of Hawthorne* (1876); *An Echo of Passion* (1882); *Acceptor* (1884); *Dreams and Days* (1892); with his wife, *A Story of Courage* (1894); and edited Nathaniel Hawthorne's works. Died in New York city, April 19, 1898.

LATHROP, ROSE HAWTHORNE, an American authoress, the youngest child of Nathaniel Hawthorne; born in Lenox, Massachusetts, May 20, 1851. Most of her childhood was spent in Europe, where she studied painting. In 1871 she married George Parsons Lathrop, and afterward wrote stories and poems for the magazines. She published *Along the Shore*, a volume of poems, in 1888, and together with her husband, a *Story of Courage*, in 1894.

LATICIFEROUS TUBES. See HISTOLOGY Vol. XII, p. 16.

LATILIDÆ, a family of fishes of the suborder *Acanthopteri*, distinguished by certain characteristics, such as subjugular ventral fins, with a spine and five branching rays and by an excess of columnar vertebrae, and truncated snout. There are but few species, one of which, belonging to *Caulolatilus*, is prized as food.

LATINI, BRUNETTO. See ENCYCLOPÆDIA, Vol. VIII, pp. 192, 193.

LATINS OR LATINI. See LATIUM, Vol. XIV, p. 343; and ITALY, Vol. XIII, p. 445.



GEORGE PARSONS LATHROP.

**LATIN UNION.** See MONEY, Vol. XVI, p. 732, note 3.

**LATINUS**, a king of Latium, according to common tradition son of Faunus and the nymph Marica, according to Hesoid, son of Ulysses and Circe. He was the father of Lavinia, whom he gave in marriage to Æneas. There are various traditions about his parentage and history, according to one of which he became Jupiter Latiaris after his death.

**LATITUDE AND LONGITUDE.** See GEOGRAPHY, Vol. X, p. 198.

**LATITUDINARIANS**, in church history, a name applied by contemporaries to a school of theologians within the English Church in the latter half of the seventeenth century, analogous to what is known today as the Broad Church party. They strove to unite the dissenters with the church by insisting only on those doctrines which were held by both and requiring merely submission to, not acceptance of, the thirty-nine Articles of the Church. The school was represented by a succession of well-known divines, among which were Burnet, Tillotson, Chillingworth, Cudworth, More and Gale, who attempted to construct a philosophy of religion at once free and conservative, in which the rights of faith and the claims of speculative intellect each should have free scope.

**LATROBE**, a post borough of Westmoreland County, southwestern Pennsylvania, 41 miles E. of Pittsburg, on the Loyalhanna Creek, at the junction of the Pennsylvania and the Ligonier Valley railroads. It contains St. Xavier's Convent and St. Vincent's College, has large coke, coal and steel industries, and manufactories of paper, bricks, mowers, and reapers, brewery products, flour and machinery. Population 1890, 3,580; 1900, 4,614.

**LATROBE, BENJAMIN HENRY**, an English-American architect; born in Yorkshire, England, May 1, 1764. After being educated in a Moravian seminary in Saxony and at the University of Leipsic, he served in the Prussian army as a cornet of hussars, and was wounded twice. Having resigned his commission, he returned to England, became an architect, and in 1789 was made surveyor of the public offices in London. In 1796 he moved to the United States; he was engineer of the James River and Appomattox canal; built the penitentiary in Richmond, the Bank of Pennsylvania in Philadelphia, the Schuylkill water-works, which supply Philadelphia with water, the Roman Catholic cathedral in Baltimore, etc. He completed the capitol at Washington in 1811, and after it was burned by the British in 1814 he was called to rebuild it. In 1812 he became interested with Fulton in steamboating on the western waters, and built the *Buffalo* at Pittsburg, the fourth steamer that descended the Ohio River. He was engaged in erecting water-works for the city of New Orleans at the time of his death, which occurred Sept. 3, 1820. See ARCHITECTURE, in these Supplements.

**LATROBE, BENJAMIN HENRY**, an American engineer, son of the preceding; born in Philadelphia, Dec. 19, 1807. After studying law, and becoming a barrister, he abandoned the profession and became an engineer of the Baltimore and Ohio railroad. In 1842 he became the chief engineer of the road, and

as such completed it from Harper's Ferry across the Alleghanies to Wheeling. He also built other roads, was consulting engineer of the Hoosac tunnel, and one of the advisory board to whom John A. Roebling submitted his plans of the Brooklyn bridge. He died in Baltimore, Oct. 19, 1878.

**LATTER-DAY SAINTS, CHURCH OF JESUS CHRIST**, OF, more generally known as Mormons. The history, organization and doctrines of this religious sect are given in Vol. XVI, pp. 825-828, up to a time prior to the legislation by Congress that drove them from their practice of polygamy. It has been a misfortune of the Mormons, as must be the case with any society that avowedly countenances a moral scheme at variance with the standards of civilization, that they are, for the most part, described by unfriendly pens. They claim that they are not justly represented. Their religion, however fantastic or superstitious it may be regarded by outside observers, has been to them a genuine aspiration for righteousness, and it is not credible that scores of thousands of people could live together in peaceful industry upon a general basis of sensuality. They have been a frugal, simple people for the most part, observing order and justice among themselves, turning a forbidding wilderness into a garden and founding a prosperous state equipped with the institutions of civilization.

Attention has been turned so exclusively upon their system of plural marriages, that it seems to many as if polygamy were the household system observed. This is far from having been the case. Carroll D. Wright, in his report to Congress in 1880 on the subject of *Marriage and Divorce*, says of the Latter-Day Saints:

"Unfortunately the statistics of church marriage, whether single or plural, for time or for eternity, cannot be presented. Every effort was made to obtain them, but without success. The assistant historian and recorder averred that he could not give an approximation which would be of any service. It is nevertheless a mistake to suppose that even a majority of the Mormon population of Utah are, openly at least, polygamists. This class of persons has been disfranchised by Congress, and the returns from the last territorial election seem to indicate that their number is not as large as has been generally supposed." So slight was the hold of plural marriages, that the courts were able to eradicate them with no great opposition from the people. There were physical and economical impediments to the general practice of polygamy. In Utah the males number 53 to each 47 females of the people, a condition of things fatal to a common observance of polygamy. Nor were the mass of the young men rich enough to contemplate a step that would make domestic expense burdensome.

But there were also ecclesiastical checks upon the practice. If a man contemplated taking a wife or wives to be added to his first living spouse, he was obliged by rule to apply to the president of the church, whose duty it was then to "inquire what the will of the Lord" in the matter was, for it was, and still is, held that God makes continual revelations to his people. If the oracle were favorable,



the applicant must first attempt to gain the consent of his living wife, although he might proceed, in case of her contumacy, to espouse the second woman of his choice. At the marriage ceremony it was the duty of his first wife to present the second bride to him, somewhat after the example of Sarah or Rachel and Leah. Clearly, the frequency of plural wives was determined by the president of the church, whose power was very great, and not by the caprice of the parties proposing the contract. Defenders of the system maintained that the Old Testament approved and the New Testament nowhere forbade the practice. They also alleged a mystical argument for it, founded upon the redemption of mankind.

In Mormonism two marriages were recognized—one temporal or for this life, the other eternal and spiritual. In the former case the contracting persons were merely joined and death wrought their divorce; in the latter they were sealed and the relationship had no end. The second covenant was of a most solemn nature, for which ecclesiastical sanction based on the alleged distinct approval of God was requisite. A sealed marriage carried with it especial privileges. A woman could be sealed to only one man, and he might be a deceased person. If a sealed widow married again, that relation was temporary, and the fruit of the marriage was reckoned to the eternal or deceased husband. A man might espouse, either for life or for eternity, as many as he could persuade into the relationship, provided the sanction of the church were obtained.

To understand the position of the Mormon people upon this subject, it is necessary to note that they were taught a doctrine of the pre-existence of souls. All souls destined to exist on the earth were the issue in heaven of the Father-God and some eternal consort. In that state they did not come to full development, and in order that they might do so it was necessary that they should become incarnate on the earth, and these souls await the marriage of God's children on the earth, that they may be assigned bodies to animate and inhabit. It is a high duty of the saints to supply tabernacles of the flesh to receive these divine procreations of God; hence "marriage was a duty, polygamy a virtue." The spirits who opposed this divine scheme under their leader, Satan, were driven out of heaven and denied all place for an earthly incarnation, and therefore for part in the resurrection. The earth was created for the probation of saints redeemed by Christ, seeing that the "fall of man" was inevitable. Those who are saved "shall come forth in the first resurrection; and if it be after the first resurrection, in the next resurrection; and shall inherit thrones, kingdoms, principalities and powers, dominions, all heights and depths."\* They are the blessed to whom it is granted to give birth to the bodies of God-created souls, to rear them in this world for immortality and sovereignty in the eternal and redeemed kingdom of the Lord on a transformed earth.

This doctrine conferred great honor and sanctity upon maternity, and explains the desire of many a

Mormon woman to bear children, and especially to bear them to those apostles, priests or dignitaries who were the recognized recipients of God's revelations. It must be borne in mind, too, that the practice of polygamy was no private caprice, but a privilege solemnly conferred by the church upon those whom the Divine Spirit indicated as worthy of the earthly fatherhood of God's children. No doubt the doctrine was open to various abuses, but the people, and especially the women, took it seriously enough, finding in the sealed covenant an exaltation of function for time and eternity denied them in temporal marriage.

But polygamy is now swept away, and the evidence goes to show that it has been done sincerely and thoroughly. In September, 1890, President Woodruff formally announced that the church no longer taught the doctrine of plural marriages, and acquiesced in the law of the United States concerning polygamy, and this declaration was subsequently confirmed in a church conference. The announcement ended a protracted contest, for so complete was the conformity to the law of the polygamists in putting away their excess of wives, that on Jan. 4, 1893, President Harrison, by proclamation, granted amnesty to those who had not violated the law since Nov. 1, 1890; while in September, 1894, President Cleveland extended the same clemency to all who had been convicted of polygamy, on the condition of their promise to obey the law. Still further, by joint resolution of Congress, in October, 1893, the property which had been escheated by previous law, and was in litigation in the courts, was restored to the church.

These pacific results had not been easily attained. The legislation of 1862 in Congress, forbidding polygamy, remained ineffective for twenty years. Then the House of Representatives refused to seat the delegate from Utah on the ground of his plural marriage, and admitted in his place a monogamist. In 1882 the "Edmunds Bill" became a law, punishing, with fine of \$300 and imprisonment for six months, the offense of having more than one living wife or of cohabiting with more than one woman. It was rigorously enforced against Mormons after its constitutionality had been decreed by the supreme court, and it is said that 1,100 were convicted of polygamy and sent to prison, while others fled to hiding-places. In 1887 another and more drastic act of Congress was passed, and the Attorney-General was directed to bring suit to escheat the property held by the church in violation of the law of 1862, and for the confiscation of the charters of the church and all over \$50,000 held in trust. The Perpetual Emigration Fund Company, the especial agent of Mormon propagandism, was stripped of its possessions, and provision was made for turning over these escheated funds to public schools in the territory. A "test oath" was also imposed to prevent polygamists from exercising the electoral franchise or serving on a jury. These confiscating laws were resisted in the courts until terminated in 1893 by Congress, as related above.

In 1887 those Mormons who opposed polygamy held a constitutional convention in Salt Lake City

\*See *Doctrines and Covenants of the Church of Jesus Christ of Latter-Day Saints* (Salt Lake City, 1886).

to frame a fundamental law for the state of Utah, but Congress did not accept its proposals. Ultimately these were incorporated, for the most part, in the constitution made by the convention called under the "Enabling Act" of 1894, and under which Utah was admitted to the Union, Jan. 4, 1896. This instrument provides for the suppression of polygamy, for complete religious toleration, and for a system of public schools free from sectarian control; and these provisions are not to be revoked by Utah without the consent of the United States.

On the 6th of April, 1893, the great temple at Salt Lake City was dedicated, forty years after its corner-stones were laid. It is a building 186½ feet long and 99 feet in width, having three towers at each end, of which the east-central one reaches 222½ feet and is surmounted by a gold-plated bronze figure of the angel Maroni who revealed the hiding-place of the tablets of the Book of Mormon. The interior rooms are symbolical, and are used for the ceremonies of the church. The temple is lighted by electricity, and is said to have cost about twelve million dollars. It is of gray granite.

**DOCTRINE.** The Mormon representation of their own tenets is as follows: "We believe in God, the Eternal Father, and in his Son, Jesus Christ, and in the Holy Ghost. We believe that men will be punished for their own sins, and not for Adam's transgression. We believe that through the atonement of Christ all mankind may be saved by obedience to the laws and ordinances of the Gospel. We believe that these ordinances are, (1) faith in the Lord Jesus Christ; (2) repentance; (3) baptism by immersion for remission of sins; (4) laying on of hands for the gift of the Holy Ghost. We believe that a man must be called of God by 'prophecy and by the laying on of hands,' by those who are in authority, to preach the Gospel and administer in the ordinances thereof. We believe in the same organization that existed in the primitive church, viz., apostles, prophets, pastors, teachers, evangelists, etc. We believe in the gifts of tongues, prophecy, revelation, visions, healings, interpretation of tongues, etc. We believe the Bible to be the word of God, as far as it is translated correctly; we also believe the Book of Mormon to be the word of God. We believe all that God has revealed, all that He does now reveal, and we believe that He will yet reveal many great and important things pertaining to the kingdom of God. We believe in the literal gathering of Israel and in the restoration of the ten tribes; that Zion will be built upon this continent; that Christ will reign personally upon the earth, and that the earth will be renewed and receive its paradisiac glory. We claim the privilege of worshipping Almighty God according to the dictates of our own conscience, and allow all men the same privilege, let them worship how, where or what they may. We believe in being subject to kings, presidents, rulers and magistrates, in obeying, honoring and sustaining the law. We believe in being honest, true, chaste, benevolent, virtuous, and in doing good to all men; indeed, we follow the admonition of Paul: 'We believe all things, we hope all things'; we have endured many things, and

hope to be able to endure all things. If there is anything virtuous, lovely, or of good report or praiseworthy, we seek after these things."

Missions are an important feature of Mormonism, members of the seventies as well as the apostles being sent forth, at the will of the first president, to secure converts. Successful missions have been established in Great Britain, Norway, Denmark, Germany, France, Switzerland and Australia. Recent colonies have been established in Mexico and in the Northwest Territory. One at Lee's Creek, Alberta, numbered, in 1893, over one thousand souls. All these have abandoned polygamy. The total number of Mormons in the United States in 1896 is given at about 330,000, of whom more than one third are of foreign birth, Great Britain and Scandinavia furnishing the largest proportion of them. Two thirds of the Mormons live in Utah; the other third are distributed, in their order of importance, in Idaho, Arizona, Iowa, Missouri, and in insignificant numbers in all but six states of the Union.

Two schisms have divided the church. The first was occasioned by the publication in 1851 of the revelation authorizing polygamy. Many denied the authenticity of this "revelation," and, under the leadership of the widow and sons of Joseph Smith, withdrew from the church and established the *Reorganized Church of Latter-Day Saints*, whose official headquarters are at Lamoni, Decatur County, Iowa. There they have a publishing-house and issue three periodicals, *Saints' Herald*, *Zion's Hope*, and a monthly, *Autumn Leaves*. They also support a college and a home for poor ministers. They have more than thirty thousand members. Their faith and church rule is essentially similar to that of the Latter-Day Saints, except in two particulars. They profess to believe "that marriage is ordained of God, and that the law of God provides for but one companion in wedlock for either man or woman, except where the marriage contract is broken by death or transgression." They believe in the supreme authority of the Bible, and that the Book of Mormon and the Doctrine and Covenants are auxiliary to the Bible, and, as opposed to the Utah Church, deny the supremacy of the "living oracles" or priesthood. They believe in continuous revelation through the head of the church, but that the revelations become binding only when approved in the church by "common consent." They claim to be the direct successors of the original church founded by Joseph Smith, and were so designated by the court of common pleas in Lake County, Ohio, in a successful suit for possession of property claimed by the Mormon Church. Possession of the lands at Independence, Missouri, the site of the future "Zion," is still being contested.

They have no salaried ministers, but support the families of missionaries or others who devote their entire time to the service of the church. They do missionary work in nearly all parts of the Union, including the state of Utah, in parts of Europe and Australia, in the Hawaiian and Society islands, and at a few other points.

Another secession occurred in 1869 in Utah, when

a considerable number, opposed to the hierarchical despotism of the Melchisedek or spiritual priesthood, withdrew and organized the *Church of Zion*.

Interest, towards the close of the year 1899, was aroused over the country on the subject of Mormonism owing to the election in Nov., 1898, to the Fifty-sixth Congress of a polygamist, Mr. Brigham H. Roberts, of Utah. At the roll call in the House of Congress, Dec. 4, 1899, Mr. Roberts answered to his name, when opposition was made to his taking a seat in the House owing to his polygamous proclivities. A monster petition was also presented praying that he be excluded from Congress, while a motion was made by Mr. R. W. Taylor, of Ohio, referring the matter of admission to a special committee. This was agreed to, the disposition of the case finally (Jan. 25, 1900) being that Mr. Roberts, by a vote of 268 to 50, was excluded from the House and refused mileage.

See *Geschichte der Mormonen*, Olshausen; *The Mormons*, by Jules Remy (1860); *The City of the Saints*, by R. F. Burton (1861); *The Church of Jesus Christ of Latter-Day Saints*, by James H. Anderson (1893).

**LATUDE, HENRI MASERS DE**, a French adventurer; born at Montagnac, Languedoc, March 23, 1725. A young artillery officer, he sought to make himself conspicuous by revealing to Madame de Pompadour a plot to poison her. The plot was discovered to be of his own contriving, and he was sent to the Bastille in 1749. In spite of ingenious efforts to escape, he remained in prison till 1777, when he was released on condition of living in his native village. But having come to Paris again, he was imprisoned till 1784. When the revolution broke out, the case was brought before the public and used as a means of exciting hatred against the old régime. In 1793 a court awarded him 60,000 livres in damages to be paid by the heirs of Madame de Pompadour. He died Jan. 1, 1805.

**LAUDANUM**. See OPIUM, Vol. XVII, p. 793.

**LAUDERDALE, JAMES MAITLAND, EIGHTH EARL** of, an English political economist; born at Hatton, Midlothian, Jan. 26, 1759. He was educated in the Universities of Edinburgh and Glasgow, and in 1780 entered the House of Commons. He was one of the managers of the impeachment of Warren Hastings in 1788, and in the following year succeeded to the peerage. He was chosen one of the representative peers of Scotland in 1790, which position he resigned afterward. At the outbreak of the French Revolution he sympathized with the movement, and made a trip to France, where he became personally acquainted with several of its leaders. He also opposed, in Parliament, the coalition against France. In 1806 he was made Peer of the United Kingdom, Keeper of the Great Seal of Scotland, and Privy Councillor. He was the author of several pamphlets on politics, economics, etc., and of the book, *Inquiry into the Nature and Origin of Public Wealth* (1804), in which he criticised the then recent *Wealth of Nations*, by Adam Smith. He died Sept. 13, 1839.

**LAUDERDALE, JOHN MAITLAND**. See MAITLAND, Vol. XV, p. 308.

**LAUDON, GIDEON ERNST**, an Austrian general

of Scotch descent; born at Troetzen, Livonia, Oct. 10, 1716. He entered the Russian military service at 15, and reached the rank of lieutenant; entered the Austrian army as captain, and served without particular distinction until the outbreak of the Seven Years' War. In 1756 he was made lieutenant-colonel, major-general in 1757 and lieutenant-general in 1758. At Hoch-Kirchen, in that year, he won the battle for the Austrians under Count Daun against the Prussians, under Frederick the Great; and in the following year, at Kunersdorf, saved the day for the Russians. In 1760 he commanded the Austrian forces in the battle of Landshut, when the Prussians were again defeated, and in the Austrian defeat, near Leignitz, in Silesia, won the admiration of Frederick the Great by his masterly retreat from the field. At the close of the war he was made baron, and in 1778 field-marshal. He commanded the Austrian army in the Turkish war, and captured Belgrade. He died July 14, 1790.

**LAUGHING-GAS OR NITROUS OXIDE**. See CHEMISTRY, Vol. V, pp. 512, 514.

**LAUGHING-JACKASS**, an Australian bird. See KINGFISHER, Vol. XIV, p. 82.

**LAUGHLIN, JAMES LAURENCE**, an American economist; born in Deerfield, Ohio, April 2, 1850. He was graduated at Harvard in 1873; chosen instructor of political economy at Harvard in 1878, assistant professor in 1883. He was president of the Philadelphia Manufacturers' Mutual Fire Insurance Company from 1888 to 1890; professor at Cornell from 1890 to 1892; and after the latter year, at the head of the department of political economy in the Chicago University. He published *The Study of Political Economy* (1885); *The History of Bimetallism in the United States* (1886, 2d edition, 1895); *The Elements of Political Economy* (1887); and edited Mill's *Political Economy*, with notes (1884). In 1895 he entered into debate with the free-silver advocate, W. H. Harvey, and published *Facts about Money* in the same year.

**LAUNDRY MACHINERY**. A large amount of machinery is required to equip a modern, up-to-date laundry. The preferred form of washing-machine is known as a hydraulic washer, and is a large cylindrical affair, set on its side. Within is a smaller perforated cylinder, which is rotated by gearing and pulley mechanisms. When the water-tight lid is clamped down and the hot water turned in through a pipe, the inner cylinder is rotated at a speed of 135 to 170 revolutions per minute, and the soap and friction loosen the dirt from the clothes. Dash-wheels, somewhat similar to those of the cotton manufacturer, are also used to toss the clothes about and wash them. For drying the clothes, centrifugal extractors are used, these being baskets of tinned copper, 22 to 26 inches in diameter, which are made to rotate at the rate of 400 to 500 turns a minute, within a case, thus draining out the water. A tumbler is often used after the extractor, to loosen the tightly-matted clothes that come from the extractor-baskets. It is simply a horizontal barrel, with internal longitudinal strips, and, being rotated at a slow speed, loosens the mass of clothes without injuring them. The steam drying-closet is a

room having a door made of a series of upright panels, each of which may be drawn out separately, like drawers from a table. To each upright panel are attached horizontal bars, on which clothes are hung. A large amount of clothes is thus taken care of in a small space, the heating being done by means of steam-coils, which may be introduced in any desired quantity. Mangles are made in a number of patterns, some of them being heated by gas. The larger sizes have steam-cylinders, 24 by 100 inches, and are arranged to iron the goods on both sides, as for giving a soft satin finish to table linen. Several ingenious forms of starchers are made, what is known as the dip-wheel starcher being preferred for collars and cuffs. Machines for dampening collars and cuffs, and other machines for shirts, are manufactured, with large rubber rolls for drawing the goods under the sprinklers. The collar-and-cuff ironer has received a great deal of attention, and is made in more styles than any other laundry machine. The simple form used in small laundries consists of one or more hot covered cylinders, which roll over the goods, or between which the goods are passed and ironed by pressure. The most efficient machine of the class, and the one which gives the highest gloss demanded for this sort of linen, is manufactured in Troy, New York, and has a capacity of 14,000 pieces per day. The laundry pieces are fed in, like sheets of paper to a small printing-press, and passed over and under three hot rolls. Another collar-and-cuff ironer is made with graphite bearings for the hot rolls, so that no oil has to be used, and the danger of soiling the clothes is avoided. In the best machines the drums are all covered with seamless felt coverings, which are sufficiently soft so that the pressure will not split the edges of the collars and cuffs, a fault which many patrons of laundries have discovered to be only too common. A special pressing-machine is made for finishing the inside points of standing collars. There are also shirt-ironers with interchangeable bosom-boards, combined collar, cuff and shirt ironers, neck-band ironers, inside and outside band ironers, sleeve-ironers, body-ironers, etc. A special machine is made for folding collars, and another for shaping the ironed collars and cuffs to circular form. The fluters and seam-dampening machines are other convenient mechanisms. Special forms of stoves are built, with tiers for heating sad-irons and polishing-irons. Some of them will heat nearly a hundred irons at once. A considerable variety of minor conveniences are also manufactured for laundry use, most of them, like the larger machines, having come into use within the past twenty years.

C. H. COCHRANE.

LAUNITZ, ROBERT EBERHARD, a Russian-American sculptor; born at Riga, Russia, Nov. 4, 1806. After studying under Thorwaldsen at Rome, he settled in New York, in 1828, and became the first instructor of Thomas Crawford. He was made a member of the National Academy in 1833. Launitz executed the battle monument at Frankfort, Kentucky; the Pulaski monument at Savannah, Georgia; the monument to Gen. G. A. Thomas at

Troy, New York, and other similar works, many of which are in Greenwood Cemetery, Brooklyn. Launitz has been called the father of monumental art in America. He died in New York, Dec. 13, 1870.

LAURACEÆ, a family of dicotyledonous plants, consisting of trees or shrubs. The family contains about one thousand species, mostly in the forests of tropical South America and Asia. An aromatic and fragrant character pervades the order, and among its products are cinnamon, camphor, and many valuable drugs and timber-woods. The sassafras, bay and spice-bush are the common representatives of the family in the United States.

LAUREATE, POET, an office in the household of the sovereigns of Great Britain. The term "laureate" was applied, so we are told in early English history, at first to graduates of the universities who had earned the laurel wreath for excellence in rhetoric and versification; later, to any poet of unusual merit. The office of royal poet was not established until 1591. Previous to that time, as early as the reign of Henry I, poets were a part of the king's household. It is recorded that Richard I and Edward I each carried with him, the one to Palestine, the other to Scotland, versifiers to sing his exploits. The compensation of these poets is not known. Later, Chaucer was attached to the royal household, granted a pension, an allowance for robes, and, as a special favor, allowed a gallon of wine a day (which was afterward commuted to an annuity of 20 marks). The first poet-laureate, as the term is used in the modern sense, was Spenser, appointed by Queen Elizabeth in 1591, and granted a pension of £50. Ben Jonson, in 1619, was the first to receive the office by letters-patent. To Jonson was granted a salary of £100 and a tierce of canary. This additional perquisite of wine was continued until the appointment of Pye in 1790, when it was commuted to £27 additional salary. Until Tennyson's appointment in 1850, the salary was £127 and the £27 for wine. In 1850 this was changed to £72. For a number of years it was the duty of the poet-laureate to write an ode on the birthday of the monarch, but this custom has been discontinued since the reign of George III. The office is now entirely honorary. The following are those who have held the laureateship, together with their terms of office: Edmund Spenser, 1591-99; Samuel Daniel, 1599-1619; Ben Jonson, 1619-37; an interregnum until 1660; William Davenant, 1660-68; John Dryden, 1670-89; Thomas Shadwell, 1689-92; Nahum Tate, 1692-1715; Nicholas Rowe, 1715-18; Lawrence Eusden, 1718-30; Colley Cibber, 1730-57; William Whitehead, 1757-85; Thomas Warton, 1785-90; Henry James Pye, 1790-1813; Robert Southey, 1813-43; William Wordsworth, 1843-50; Alfred Tennyson, 1850-92; an interregnum until 1896; Alfred Austin, 1896.

LAUREL, a town of Prince George County, central Maryland, eighteen miles N.E. of Washington, on the Big Patuxent River and the Baltimore and Ohio railroad. It has a cotton factory and iron-works. Iron ore and fine building-stone are found in the vicinity. Population 1880, 1,206; 1890, 1,984; 1900, 2,079.

**LAURENS, JEAN PAUL**, a French painter; born at Fourquevaux, March 28, 1838. He was a pupil of Bida and Léon Cogniet; received a first-class medal at the salon of 1872; made officer of the Legion of Honor in 1878. Among his best-known canvases are *The Death of the Duke of Enghien*; *The Excommunication of Robert the Pious*, now in the Luxembourg; *The Death of Marceau*, purchased by the city of Ghent for 40,000 francs; and *The Interdict*, in the Museum at Havre. Laurens is considered one of the best of modern historical painters.

**LAURENTIAN HILLS.** See QUEBEC, Vol. XX, p. 166.

**LAURENTIAN SYSTEM.** See GEOLOGY, Vol. X, pp. 327, 328.

**LAURENTIUS, LORENZO, SAINT.** See LAWRENCE, Vol. XIV, p. 370.

**LAURIER, SIR WILFRID**, a Canadian statesman; born at St. Lin, Quebec, Nov. 20, 1841. He was



WILFRID LAURIER.

educated at L'Assomption College, and was admitted to the bar in 1865, although it was his original intention to become a priest. He drifted into journalism, and first won notice by his attacks on abuses in church and state. His articles on the former subject caused his permanent exclusion from the Catholic Church. From 1871 to 1874 he was in the Quebec Assembly. He then entered the Dominion Parliament, and in 1877 was appointed Minister of Inland Revenue, a position which he held until 1878. On the retirement of Edward Blake in 1887 from the leadership of the Liberal party in Parliament, M. Laurier was unanimously chosen to succeed him. After the general election in the spring of 1896, in which the Liberals were successful, Mr. Laurier became Premier of Canada. He was knighted in 1897.

**LAURIUM**, a range of hills forming the S.E. portion of Attica, Greece, famous in ancient times for rich mines of silver, lead, zinc and antimony. The mines at one time were supposed to be exhausted, and were deserted. Since 1863, however, the scoriæ and refuse ore have been worked with profit, and the mines themselves have been reopened. They are connected with the port of Ergasteria by a railway seven miles long.

**LAUSSE DAT, AIMÉ**, a French scientist and soldier; born at Moulins, April 19, 1819. He was educated at the École Polytechnique, and in 1840 entered the engineering department of the French army. He was employed in the fortifications of Paris and in the Pyrennees; in 1851 became tutor at the École Polytechnique; professor of geodesy and astronomy in 1856; professor of geometry in the Conservatoire des Arts et Métiers (1865). During this time he retained his commission in the army; was made captain in 1853; commandant in 1863;

lieutenant-colonel in 1870; and served in the siege of Paris. He was promoted to the rank of colonel in 1874; retired in 1879; and two years later was made director of the Conservatoire. M. Laussedat became a commander in the Legion of Honor; was the inventor of several astronomical and surveying instruments; made experiments in the uses of balloons in military operations, and in the application of photography to astronomical observations and map-drawing, and published *Lessons in the Art of Drawing Maps* (1861) and *Biographical Sketch of Gustave Froment* (1865).

**LAUZUN, ANTOINE NOMPAR DE C.** See MONT-PENSIER, Vol. XVI, p. 793.

**LAUZUN, ARMAND LOUIS DE GONTAUT, DUC DE BIRON**, a French soldier; born in Paris, in 1753; captured Senegal from the English in 1779; fought with Lafayette in the American War of Independence; defeated the Vendéans at Parthenay in 1793. He was accused of oppression and falsehood by two fellow-generals, tried by the committee of public safety, and guillotined Jan. 1, 1794. His *Memoirs* were published in 1822.

**LAVA.** See GEOLOGY, Vol. X, pp. 242-251.

**LAVAL-MONTMORENCY, FRANÇOIS XAVIER DE**, first Canadian Roman Catholic bishop; born at Laval, France, March 23, 1622. He studied at the College of La Flèche, and received the tonsure at the age of nine. Being heir to the title and estates of his family, he resigned all his rights in favor of a younger brother. After finishing his theological studies at Paris, he was ordained in 1646. In 1657 the king nominated him for the see of Quebec, but his consecration was delayed till 1658. His title was Vicar Apostolic of Quebec and Bishop of *Petræa in partibus infidelium*. He reached New France in 1659, organized parishes there, and relieved the Jesuits of their charges as pastors of parishes. In 1662 he returned to France to obtain missionaries and means for his diocese. Coming back to Canada in the next year, he set about building a large church at Quebec and founding a "grand seminaire" for the education of priests and a "petit seminaire" as a preparatory college. In 1670 the vicariate of Quebec was made a titular bishopric, and Laval returned to France in 1672 to obtain the bulls of consecration. Having come back as bishop of Quebec in 1675, he laid the foundation of the Seminary of the Holy Family, which was to take the place of the two seminaries he had founded before, and gave all his property for its support. In 1684 he resigned the administration of his diocese, and retired to the seminary he had erected. Laval was a man of pure, upright and devout character. His name is commemorated in Laval University, at Quebec (q.v., Vol. XX, p. 168). The Roman Catholic Church in Canada has petitioned the Pope for his canonization. His *Life* has been written by Louis Bertrand de la Tour (Cologne, 1751), and by an anonymous author (Quebec, 1845). He died in Quebec, May 6, 1708.

**LAVAL UNIVERSITY.** See QUEBEC, Vol. XX, p. 168.

**LAVELEVE, ÉMILE LOUIS VICTOR DE** (1822-92), a political economist. See POLITICAL ECONOMY, Vol. XIX, p. 395.

LAVER, a general name applied to many of the edible seaweeds.

LAVIGERIE, CHARLES MARTIAL ALLEMAND, a French prelate; born Oct. 31, 1825, at Bayonne. He studied theology at the Seminary of St. Sulpice and the school of the Carmelites, and was ordained priest in 1849. He was professor in the Carmelites' school from 1850 to 1853; 1854 to 1861, in the faculty of theology at Paris; in 1863, made bishop of Nancy; in 1867, archbishop of Algiers, where he came into conflict with the government by trying to establish charitable institutions among the Arabs. The contest went so far that the Emperor, Napoleon III, wrote him a personal letter, advising him to leave temporal matters to the government and confine his attention to the spiritual wants of his Catholic parishioners. The archbishop, however, continued his work. In 1882 he was made cardinal, and two years later became archbishop of Tunis and primate of Africa. Mgr. Lavigerie at first advocated a monarchical government for France, and at one time wrote to the Count of Chambord, urging him to come to France and claim his hereditary right to the throne. Later, however, he declared it to be his opinion that the church should support the Republic. The cardinal won particular attention by his vigorous opposition to the African slave-trade. He died in Algiers, Nov. 26, 1892.

LAVINIUM AND LAURENTUM, two cities of ancient Italy. See LATIUM, Vol. XIV, p. 344.

LAVISSE, ERNEST, a French historian; born at Nouvion-en-Thiérache, Dec. 17, 1842. He was chosen professor of modern history in the University of Paris in 1888; elected to the academy in 1892. He wrote historical and biographical works, mostly on German history. Among them are *Study of the Origins of the Prussian Monarchy* (1875); *Studies of the History of Prussia* (1879); *Essays on Imperial Germany* (1888); *General View of the Political History of Europe* (1890), which has been translated into English by C. Gross (New York, 1891); and *The Youth of Frederick the Great* (1892).

LAW, DEPARTMENT OF, or the DEPARTMENT OF JUSTICE, an executive department of the United States Government, presided over by the *Attorney-General*, who is a member of the President's Cabinet, and whose general duties are: To represent the United States in matters involving legal questions; to give his advice and opinion, when required by the President or by the other executive departments, on questions of law arising in the administration of their respective departments; to exercise a general superintendence over United States attorneys and marshals; and to provide the government special counsel when required. He is assisted by a chief and other clerks.

The work of this department is distributed among certain officers, as follows:

The *Solicitor-General* assists the *Attorney-General* in the conduct of all cases in the Supreme Court and in the Court of Claims in which the

United States is interested; and when the *Attorney-General* so directs, any such case in any United States court or state court may be conducted and argued by the *Solicitor-General*. He acts as the *Attorney-General* when that office is vacant or that officer is absent.

Four *Assistant Attorneys-General* assist the *Attorney-General* and the *Solicitor-General*. Two argue cases in the Supreme Court and prepare legal opinions; one defends the United States in the Court of Claims, and the other is charged with the defense of the Indian depredation claims.

The different law officers of the executive departments all perform their functions under the supervision of the *Attorney-General*. They are the *Assistant Attorney-General* for the Department of the Interior, the *Assistant Attorney-General* for the Post-Office Department, the *Solicitor of the Treasury*, the *Solicitor of Internal Revenue*, *Treasury Department*, and the *Solicitor for the Department of State*.

ATTORNEYS-GENERAL.—The following is a complete list of the *Attorneys-General* from the organization of the department, with the dates severally of their appointments: Edmund Randolph, 1789; William Bradford, 1794; Charles Lee, 1795–1797; Theophilus Parsons, 1801; Levi Lincoln, 1801; Robert Smith, 1805; John Breckinridge, 1805; Cæsar Rodney, 1807–1809; William Pinkney, 1811; Richard Rush, 1814–1817; William Wirt, 1817, 1825; John M'P. Berrien, 1829; Roger B. Taney, 1831; Benjamin F. Butler, 1833–1837; Felix Grundy, 1838; Henry D. Gilpin, 1840; John J. Crittenden, 1841; Hugh S. Legare, 1841; John Nelson, 1843; John Y. Mason, 1845; Nathan Clifford, 1846; Isaac Toucey, 1848; Reverdy Johnson, 1849; John J. Crittenden, 1850; Caleb Cushing, 1853; Jeremiah S. Black, 1857; Edwin M. Stanton, 1860; \*Edward Bates, 1861; James Speed, 1864; Henry Stanbery, 1866; William M. Evarts, 1868; Ebenezer R. Hoar, 1869; Amos T. Ackerman, 1870; George H. Williams, 1871; Edwards Pierrepont, 1875; Alphonso Taft, 1876; Charles Devens, 1877; Wayne MacVeagh, 1881; Benjamin H. Brewster, 1881; Augustus H. Garland, 1885; William H. L. Miller, 1889; Richard Olney, 1893; Judson Harmao, 1895; Joseph J. McKenna, 1897.

\*Titan J. Caffey, *ad interim*.

LAW, EDMUND. See PALEY, Vol. XVIII, p. 181.

LAW, RICHARD, an American jurist; born in Milford, Connecticut, March 17, 1733. He was educated at Yale, and was admitted to the bar in 1754; practiced at New London, where he became chief judge; was a delegate to the continental college from 1777 to 1778 and from 1781 to 1784; mayor of New London for twenty years; supreme court chief justice in his state, and district judge by Federal appointment. With Roger Sherman, he revised the Connecticut code of statute laws. He died at New London, Jan. 26, 1806.

LAW AND ORDER SOCIETIES are voluntary organizations of citizens for promoting the better administration of cities by procuring

the enforcement of the law. In the United States, municipal government has peculiar problems to confront. Cities have grown more rapidly than the capacity to control them; the citizens are generally unknown to each other, except in restricted ways, and therefore with difficulty act with concert of purpose and plan; civic pride is more a boast than a real sentiment; people of foreign birth, many of them utterly without education or discipline, crowd the tenements; population gets distributed by classes—wealth in one quarter, toil in another, and pauperism and crime in another. Out of this disorder arose a class of "practical politicians," who made public business a source of private gain, so that ignorant, unscrupulous men acquired vast wealth, either by office-holding or managing elections. They sold immunity to law-breakers, encouraged bribery, made the saloon a factor in politics, manipulated legislation for sinister ends, entrenched themselves within powerful organizations, and corrupted the sources of civic life. Men of eminence and responsibility gave stability to this system by patronizing it and seeking allies in it, in order to acquire or retain power. For a long time, society lay supine under this incubus, or, if aroused, tried only spasmodically to throw it off, while the "machine bosses," as manipulators of elections and legislatures are called, grew wanton and insolent.

When disclosure was made of the nefarious practices of the "Tweed ring" in New York in 1871, in which the authorities of the city were deeply implicated, it was seen that in order to bring the conspirators to trial it would be necessary to reinforce the ordinary operations of justice by the voluntary action of honest citizens. An able representative Committee of Seventy was organized to press the prosecution and execute the reformatory purpose of the community, and under its management the city was wrested from the control of scoundrels and they were punished. Since then similar proceedings have been adopted, as well in New York as in other large cities, when it has become necessary to rescue government from corrupt hands. Large committees of private citizens organize, which raise money to prosecute offenders, to advertise the community of corrupt deeds or designs, and of the character of the men who are seeking office, to watch registration of voters, challenge fraudulent votes, and see that the authorities conform to the requirements of law. But these committees are only temporary expedients, and things lapse into their old state when they are dissolved.

After the overthrow of the Tweed power it was felt in New York that the police and courts of the city were inadequate to deal with violators of the law unless citizens interested themselves in the administration of justice. Even where the officials were well disposed, it was often impossible to find complainants against flagrant offenders or to procure convicting evidence. In order to bring aid of this sort to the authorities, Rev.

Dr. Howard Crosby and some associates organized, in 1877, a "Society for the Prevention of Crime." Its object was to promote the enforcement of law through existing machinery and to reform the laws when necessary. It employed detectives and counsel, and went into court through its agents as complainants; it assisted grand juries with evidence; it watched the prosecution of offenders. On the death of Dr. Crosby the presidency of this society passed to Rev. Dr. Charles H. Parkhurst, who found the work so impeded by the police and their magistrates that he vigorously denounced them, and averred that he had evidence to prove their complicity with crime. He saw no relief from corrupt administration until the power of Tammany Hall was overthrown. His denunciations attracted attention, and the political opponents of Tammany thought to take advantage of them by a legislative investigation; but he declined to aid any official inquiry for partisan ends, and demanded a free and full examination of the whole corrupt business, let blame fall where it might. In 1894, at the demand of the press of the city, which had come to the aid of Dr. Parkhurst, the senate of state sent the Lexow Commission to the metropolis to investigate. This committee secured the services as counsel of John W. Goff, a lawyer of Irish birth, who in the following elections became recorder of the city, and its attention was converged on the police department. It was in session, with some intermission, for ten months; and while it failed to connect Tammany chiefs with particular crimes, it abundantly confirmed the public belief that the police levied blackmail on prostitutes, saloon-keepers, green-goods men, builders, merchants obstructing the streets, and other violators of city ordinances. There were involved in these offenses four men who had been or were police commissioners, four who had been or were inspectors, 22 who had been or were captains, and twoscore minor officers. Most of these men were afterward indicted, and the disclosures were followed by a Committee of Seventy, under whose auspices a reform municipal administration was put in power that autumn. While Dr. Parkhurst's society did not appear in this investigation, it was well understood that its work and influence instigated and animated it, and the efficiency of such organizations gained great credit everywhere, giving impulse to the formation of like agencies.

Dr. Crosby's example early began to be influential, and kindred societies sprang up in various cities, at first taking the name of Law and Order Societies, and devoting themselves especially to the suppression of social vices, as in Philadelphia, where the society has concentrated its work upon restricting the sale of liquor. Indeed, their chief field is the liquor traffic, which is too often lawless, and hence they are practical temperance societies. Besides the suppression of Sunday-opening saloons, licenses obtained by perjury, and other violations of law, these associations attempt the extinction of prostitution. In 1883 the Law

and Order societies of eight states met by delegates in Boston, and organized an International League, the executive committee of which meets monthly. It publishes a journal called the *City Vigilant*, and finds an organ in *Lend a Hand*.

This movement is strengthened by the formation of kindred societies. They may be roughly classified as they devote themselves predominantly to the suppression of crime, to the choice of suitable men for holding municipal office, or to the educational work of pointing out methods of obtaining good government. Of the first class are vigilance leagues. In 1892 the City Vigilance League of New York was formed at the instigation of Dr. Parkhurst, he becoming its first president, the objects of which are to ascertain facts concerning the social life, the official administration and the violations of law in each precinct of the city, with a view to loosening the hold of bad men on the community and improving methods of government. As a type of the second class of organization, reference may be made to the Civic Federation of Chicago, which was organized in 1894, and is in name and methods the type of a number of other reforming organizations. It aims to promote honesty and efficiency of civic administration, to bring into unison all citizens who care for the public welfare, and to discover and correct abuses of municipal government, separating city interests from state and national politics. There are scores of kindred societies scattered in the cities of the United States, bearing a great variety of names, but bent on securing government by the righteous and exact observance of law.

So profound and hopeful has been public interest in this reformation that a spirit of emulation has spread through the country in disseminating a knowledge of what constitutes good government and of the best modes of bringing it about. There are hundreds of "good-government" clubs, the aim of which is educational. These are not uniform as to name, and are of two types—those that seek mutual information and support, and those that are propagandist. The former are maintained by young people for the most part; the latter are organizations carried to toilers of the city, and aiming to stimulate them to larger civic pride and respect for administrative functions. One of the earliest of such societies is the Massachusetts Society for Promoting Good Citizenship, organized in Boston in 1887, under the presidency of Rev. E. E. Hale; but the number of related and affiliated societies is now legion, and their increase is rapid and full of promise.

D. O. KELLOGG.

LAWES, SIR JOHN BENNETT, an English agricultural experimentist; born at Rothamsted, near St. Albans, Hertfordshire, Dec. 28, 1814. After studying chemistry in London and inherited his father's estate, he began in 1834 to experiment upon the best methods of raising farm crops and the useful effects of fertilizers. In this work he had the assistance of the eminent chemist Dr. J. H.

Gilbert, who became associated with Mr. Lawes in 1843. The results of these experiments have been published in a series of reports and papers, which are everywhere acknowledged as being of the highest value. Messrs Lawes and Gilbert also made experiments on the best feed for livestock, on drainage and sewerage, in animal and vegetable physiology, and in various other departments of rural economy. Mr. Lawes was made a baronet in 1883. He endowed his agricultural station with £100,000. The results of his experiments appeared in papers and magazine articles. He died in January, 1892.

LAW OF WATER DUTY. See IRRIGATION, in these Supplements.

LAWRANCE, JOHN, an American statesman; born in Cornwall, England, in 1750. After removing to America in 1767 he was admitted to the bar of New York in 1772; became aide-de-camp to General Washington in 1777; and presided in the same year as judge-advocate-general at the trial of Major John André. In 1784 Lawrance was elected to Congress; in 1794 he was made United States judge for the New York district; and two years later he was elected to the United States Senate, over which he presided in 1798. He was an ardent patriot, and the personal friend of Washington and Hamilton. He died in New York in 1810.

LAWRENCE, a city, and the capital of Douglas County, central eastern Kansas. It lies on the Union Pacific, the Atchison, Topeka and Santa Fé and the Southern Kansas railroads, and is also the terminus of two branch railway lines. The city is the center of trade for a fertile and populous section of the state, having a favorable situation between Topeka and Kansas City. The manufactures are in a thriving condition, the most important of them being flour, woodenware, castings, furniture, barbed wire, shirts, and carriages. This city is the seat of the Kansas State University, a large and prosperous College which occupies a commanding site on Mount Oread. Here also is located Haskell Institute, a government institution for the education of Indian youth, the second largest in the United States. It has a public library, numerous periodicals and several banks. Population 1890, 9,997; 1900, 10,862. See also LAWRENCE, Vol. XIV, p. 370.

LAWRENCE, a city of Essex County, north-eastern Massachusetts. Its great natural advantages have given Lawrence its industrial importance. The town is connected with Boston by the Boston and Maine and the Boston and Lowell railroads, and with Manchester, New Hampshire, by the Manchester and Lawrence railroad. Branch railroads extend to Lowell and Salem. There are numerous cotton and woolen mills here, some of the largest in the world, the Pacific Mills employing 6,000 hands; besides establishments for the manufacture of machinery, boilers and steam-engines, boots and shoes, paper and clothing. The high-school building is a costly and imposing edifice, and there is a large public library. The town is lighted by gas and elec-



tricity, and supplied with water from the Merimac. It is connected with Lowell, Haverhill, Andover and other neighboring places by electric railway. Population 1885, 38,862; in 1890, 44,654; in 1900, 62,559. See also LAWRENCE, Vol. XIV, p. 370.

LAWRENCE, ABBOTT, an American merchant; born at Groton, Massachusetts, Dec. 16, 1792. At the age of 15 he was bound an apprentice to his brother Amos, and in 1814 he became a partner of the firm of A. & A. Lawrence, which for many years conducted a prosperous business in the sale of foreign cotton and woolen goods on commission. Abbott was an advocate of protection to American industries, and an earnest supporter of the Whig party. He served several terms in Congress. From 1849 to 1852 he served as United States minister to Great Britain; performed afterward an important service in the settlement of the fishery question, which had threatened to lead to serious complications; and in 1842 served on the commission which settled the northeast boundary. He founded the Lawrence Scientific School of Harvard University, giving and bequeathing altogether \$100,000 for this purpose. He also left \$50,000 for the erection of model lodging-houses, and established many prizes and scholarships in the public schools. He gave liberally to Groton (now Lawrence) Academy. He died in Boston, Aug. 18, 1855.

LAWRENCE, AMOS, an American merchant; born at Groton, Massachusetts, April 22, 1786. After clerking in a country store he became a dry-goods merchant in Boston in 1807. Seven years later he entered into partnership with his brother Abbott, who had been his chief clerk for the previous five years. The business operations of the firm were highly successful. In 1830 the brothers Lawrence established a cotton-mill at Lowell, Massachusetts. After a serious illness Amos retired from the business in 1831, and devoted his life afterward chiefly to deeds of charity, giving liberally to educational institutions. Among them was Groton Academy, founded by his father, and afterward named in honor of his brother; also, Lawrence University, Wisconsin, named after him. He established and maintained a child's infirmary in Boston, and gave \$10,000 for the completion of the Bunker Hill monument. His public benefactions summed up to \$639,000. He died Dec. 31, 1852.

LAWRENCE, EUGENE, an American historical writer; born in New York City, Oct. 10, 1823. He received his education in New York, and studied law in Harvard, but practiced for only a short time; traveled in Europe, devoting his time to study in all the large libraries. On his return he turned his attention to writing, contributing to several magazines; edited a *Smaller History of Rome*; published *Lives of British Historians* (1855); *Historical Studies* (1856); *The Feuds and their Persecutors*; and *Columbus and His Contemporaries*. He died Aug. 17, 1894.

LAWRENCE, GEORGE ALFRED, an English novelist; born in 1827. He was educated at Ox-

ford, and took up the practice of law in London, but devoted himself chiefly to literature. Among his works are *Guy Livingstone* (1857); *Border and Bastile* (1863); *Sword and Gown* (1868); *Anteros* (1871); and *Silverland* (1873). He died in 1876.

LAWRENCE, GEORGE NEWBOLD, an American ornithologist; born in New York City, Oct. 20, 1806. He was a New York business man who devoted his leisure to the study of birds; made a study of the avifauna of tropical and subtropical America, and described over three hundred new species. He was one of the editors of *Birds of North America*, published in 1860.

LAWRENCE, JAMES, an American naval officer; born at Burlington, New Jersey, Oct. 1, 1781. In 1802 he was made lieutenant and took part in the war with Tripoli, where he distinguished himself on several occasions. In 1811 he was promoted to a captaincy, and made commander of the United States gunboat *Hornet*. In a fight with the English brig-of-war *Peacock*, off Demerara, Lawrence sank the latter after an engagement of fifteen minutes. For this victory he received the thanks of Congress. In 1813, as commander of the frigate *Chesapeake*, Lawrence had an engagement near Boston with the British frigate *Shannon*, under Capt. P. V. Broke. Lawrence was shot, and the *Chesapeake* was captured in spite of his dying cry, "Don't give up the ship!" on being carried below. He died July 5, 1813.

LAWRENCE, WILLIAM BEACH, an American jurist; born in New York City, Oct. 23, 1800. He was educated at Columbia College; went to Europe in 1821; was admitted to the bar on his return in 1823; was appointed secretary to the legation in London, 1827; *chargé d'affaires* there the next year; spent some time in Paris, and returned home in 1832; devoted himself to his profession for some time, and was interested in the Erie railway. In 1850 he removed to Rhode Island, where he became acting governor in 1851 and a member of the Constitutional Convention of 1853. He was a lecturer in Columbia Law School, and in 1869 was a member of the Social Science Congress which met in Bristol, England. Among his numerous works are *History of the Negotiations in Reference to the Eastern and Northeastern Boundaries of the United States* (1841); an edition of Wheaton's *International Law* (1855); *The Law of Charitable Uses* (1845); *Visitation and Search* (1858); *The Treaty of Washington* (1871); *Belligerent and Sovereign Rights as regards Neutrals during the War of Secession* (1873); and *Administration of Equity Jurisprudence* (1874). He died March 26, 1881.

LAWRENCEBURG, a city and the capital of Dearborn County, southeastern Indiana, situated on the Ohio River, and on the Cleveland, Cincinnati, Chicago and St. Louis and the Baltimore and Ohio Southwestern railroads, at the southern terminus of the Whitewater canal, 22 miles below Cincinnati. It has breweries, distilleries, and barrel, carriage, coffin, flour, pump, piano and furni-

ture manufactories. Pop. 1890, 4,284; 1900, 4,326.

**LAWRENCEBURG**, capital of Anderson Co., Ky., 24 miles W of Lexington. It is in a grain (especially corn) and tobacco-raising region; chief industry, whisky-distilling. Population 1900, 1,253.

**LAWRENCE UNIVERSITY**, a co-educational institution in Appleton, Wis., established in 1849, named after Amos Lawrence, who gave \$10,000 to start it, and controlled by the Methodist Episcopal Church. There are three courses of study: the ancient classical, the modern classical, and the scientific; also a preparatory course, an English course, and courses in music and painting. In 1898 there were 378 students, 23 instructors, and a library containing 15,620 volumes. There are a large recitation hall, a dormitory, and an observatory.

**LAW SCHOOLS.** See **LEGAL EDUCATION**, in these Supplements.

**LAWTON, HENRY W.**, American army officer, was born in Ohio, March 17, 1843. He was appointed to the army from Indiana, and on the outbreak of the Civil War, in April, 1861, he entered

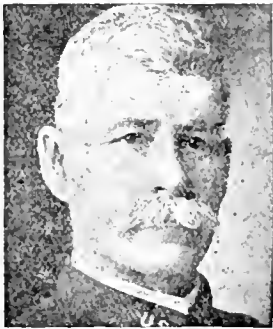

HENRY W. LAWTON.

Company E of the Ninth Indiana Volunteer Infantry as sergeant, but was discharged in July following, and joined the Thirtieth Indiana Volunteer Infantry as first lieutenant. He was promoted captain May 17, 1862, and lieutenant-colonel Nov. 15, 1864. He won the rank of brevet colonel of the volunteers for gallant conduct during the war,

and was honorably mustered out in November, 1865. In July, 1866, he entered the regular army as second lieutenant of the Forty-first Infantry, and was made first lieutenant in July, 1867; captain in March, 1879; and lieutenant-colonel on Feb. 12, 1889 and assigned to the inspector-general's department. After the war with Spain broke out he was made major-general of volunteers and commander of the Second Division of General Shafter's army at Santiago de Cuba, and distinguished himself at the battles at El Cancey, July 1-2, 1898.

In Jan. 1899, he was ordered to the Philippines as second in command to General Otis. He reached Manila early in March and took command on the 18th of the 1st division of the Eighth Army Corps. Throughout the year he was actively engaged in expeditions in Luzon, both north and south of Manila, his operations against the Filipino insurgents meeting with marked success. Within the period he engaged in over twenty fights and captured some thirty towns, including Santa Cruz and San Isidro, and won the battle of Zapoti Bridge (June 13). From Oct. to Dec. his operations were chiefly in the north; his last expedition was against San Mateo, where a number of the hard-pressed insurgent forces had made a stand. Here, on Dec. 19, 1899, Lawton was killed in an attack upon the entrenchments of the place, greatly to the regret not only of his com-

mand, but to the whole United States nation, which recognized his gallantry and the great service he had rendered in the Philippines in breaking up and scattering the disaffected island forces of Aguinaldo and his compatriots.

**LAYARD, SIR AUSTEN HENRY**, an English traveler and diplomatist; born in Paris, March 5, 1817; passed his boyhood in Italy, and commenced his career as correspondent at Constantinople of a London paper. With the assistance of Sir Stratford Canning, in 1845, he began a series of discoveries of Assyrian antiquities, of which he gave an account in his *Nineveh and its Remains* and *Monuments of Nineveh*; and in 1849 undertook for the British Museum a series of excavations in Assyria and Chaldea. In 1852 he sat as member of Parliament for Aylesbury, and in 1860 for Southwark; in 1861-66 he was Under-Secretary of State for Foreign Affairs, and thereafter Chief Commissioner of Works. He was appointed ambassador at Madrid in 1869, and in 1877 was sent as plenipotentiary to that city. In April, 1877, he was made ambassador at Constantinople, and negotiated the treaty for the surrender of Cyprus to England. Died in London, July 5, 1894.

**LAZZARONI**, formerly a lower class of people in Naples, named from the Hospital of St. Lazarus, their place of refuge. From the Middle Ages they inherited the obligation to wear a special dress of the simplest kind, and were treated by the government as a separate class, electing their own chief, called *Capo Lazzaro*. See **NAPLES**, Vol. XVII, 190.

**LEA, HENRY CHARLES**, an American author; born in Philadelphia, Sept. 19, 1825. At the age of 17 he entered the publishing-house of his father, of which he afterward became the principal. He published several papers on chemistry and conchology, notably *Description of New Species of Shells*. During the Civil War he organized a municipal system of bounties for recruits to encourage volunteering, and wrote much for periodicals. After 1857 he devoted special attention to mediæval history, and wrote *Superstition and Force* (1866); *Essays on the Wager of Battle* (1866); *Sacerdotal Celibacy* (1867); *Studies in Church History* (1869); *History of the Inquisition of the Middle Ages* (1888); *Chapters from the Religious History of Spain* (1890); *A History of Sacramental Confession and Indulgences in the Latin Church* (1894). The Philadelphia Library received \$50,000 from him for expanding its facilities.—His brother, **MATTHEW CAREY LEA**, born in Philadelphia, Aug. 18, 1823, devoted himself to photographic chemistry, and published articles on the chemical effects of light, especially on the haloid salts of silver. He wrote *Manual of Photography* (1868). Died at Philadelphia, March 15, 1897.

**LEA, ISAAC**, an American naturalist of Quaker stock; born in Wilmington, Del., March 4, 1792. His mother fostered his natural fondness for botany, and his friend Lardner Vanuxem encouraged his interest in mineralogy and geology. In 1815 he became a member of the Philadelphia Academy of Natural Sciences, and 1853-58 was its president. Having married Matthew Carey's daughter, in 1821, he became a partner in Carey's publishing-house, and con-

tinued in the book-publishing business until 1857. But he devoted his leisure hours to science. In 1827 he commenced the publication of a series of memoirs on fresh-water and land shells. His first paper was on the genus *Unio*. His specimens of this genus alone number 10,000. He read before the Philadelphia societies at least 150 memoirs on natural history. Among his published writings are *Contributions to Geology; Fossil Footmarks; Observations on the Genus Unio* (1827-74). This last work forms 13 quarto volumes, magnificently illustrated. In 1858 he was elected president of the Philadelphia Academy of Natural Sciences, and of the American Association of Sciences in 1860. He bequeathed his valuable collection of fresh-water shells, land and marine shells, minerals, fossils and geological specimens to the National Museum in Washington. He discovered the footprints of *Clepsysaurus Pennsylvanicus*, a large saurian, in the red sandstone of Pottsville, Pennsylvania, 700 feet below the conglomerate of the coal formation, and subsequently found many bones and teeth of this fossil animal. This discovery was of great interest, for the existence of an air-breathing animal as low as the coal measures had not at that time been definitely accepted. He died in Philadelphia, Dec. 7, 1886.

**LEAD CITY**, a city of Lawrence County, central western South Dakota; situated among the Black Hills, three miles S. of Deadwood, the county seat; on the Fremont, Elkhorn and Missouri Valley railroad. Situated here is one of the largest gold-mines in the world, there being in operation over 600 stamps. The yield of the district in 1895 was over \$2,250,000 in gold. Gold jewelry is manufactured. Population 1880, 1,437; 1890, 2,581; 1900, 6,210.

**LEADING QUESTION.** See EVIDENCE, Vol. VIII, p. 743.

**LEAD PLASTER**, in pharmacy. See GLYCERINE, Vol. X, p. 698.

**LEADVILLE**, a city of western central Colorado, the fourth in size and importance in the state. The city is situated near the Arkansas River, on California Gulch, just W. of the Mesquite range, on the Denver and Rio Grande, the Colorado Midland and the Denver, Leadville and Gunnison railroads. The surrounding scenery is grand and imposing. Leadville is the leading silver-mining center of Colorado. It is surrounded by the richest mines furnishing carbonate-of-lead ores; but other silver-bearing ores are also abundant, and during a few years past much gold has been mined. It has several smelting and ore-reduction works; also several stamp-mills where gold-bearing quartz is comminuted and the precious metal is amalgamated. Its population in 1890 was 10,384; but in 1900 it had risen to 12,455. The decrease is accounted for by the removal of some of the large smelting works to Denver, Pueblo and Colorado Springs. See also LEADVILLE, Vol. XIV, p. 379.

**LEADVILLE MINES.** See SILVER AND SILVER-MINING, in these Supplements.

**LEAF.** See BOTANY, Vol. IV, pp. 117-119.

Vol. 3-36

**LEAF-CUTTER BEES**, the popular name of several species of *Megachile*, which line their nests with pieces of leaves. Sometimes they construct burrows, which they line, but usually they make use of narrow crevices. They are often called "upholsterer" bees. *M. centuncularis*, a common species in Europe and the United States, uses rose-leaves with which to line its dwelling. The genus is cosmopolitan in distribution.

**LEAF-INSECT OR WALKING-LEAF**, popular names given to certain orthopterous insects of the family *Shasmidae*. The insects of the genus *Phyllium* have wings remarkably leaf-like in appearance. They are very interesting to students of mimicry. This genus is largely confined to the East Indian region. See INSECTS, Vol. XIII, p. 152; and MIMICRY, Vol. XVI, p. 343.

**LEAF-ROLLER**, the larva of any moth of the family *Tortricidae*, which makes a case for itself by rolling up the leaves of plants. The number of genera and species is great, and as a rule the insects are very destructive of useful vegetation. Common leaf-rollers of the United States are the strawberry leaf-roller *Phoxoptera fragariae*, and the cotton or rose-leaf roller *Lozotania gossypiana*. The latter works on the leaves of cotton, rose, clover, birch, apple, and many other trees and plants.

**LEAF-SPOT**, the general name given to a pathological condition of leaves, which may be caused by a number of different parasitic fungi. The ordinary fungicides are usually of no avail in eradicating this pest, for the condition is caused by internal parasites. To get thoroughly rid of spot-disease, the affected leaves should be burned. The ravages of this disease are most serious in the case of strawberry leaves. A strawberry patch, when so attacked, must be mown, let dry, and burned over. *Ramularia tulasnei* is the cause of the strawberry leaf-spot, producing yellowish-white spots edged with red or purple, which, in ripening, bear small, dark, oval bodies (*sclerotia*) from which the fungus is reproduced in the following season. *Septoria cerasina* produces deep purple spots upon plum and cherry leaves, and rapidly kill them. *Cercospora beticola*, or "beet rust," is a common pest of the sugar and garden beets. It causes rapidly spreading, light-colored patches of dead tissue. See *Spot-disease of Strawberry-leaves* (University of Wisconsin, 1884).

**LEAGUE OF AMERICAN WHEELMEN**, THE, an organization founded at Newport, Rhode Island, May 31, 1880, for the purpose of promoting the general interests of cycling; for ascertaining, defending and protecting the rights of wheelmen; for encouraging and facilitating touring; for promoting the improvement of the public roads and highways; and for regulating all amateur sports connected with the use of the wheel. The initiative was taken by Kirk Monroe, president of the New York Bicycle Club, and a start was made with two dozen clubs and 133 members. In September, 1880, the organization was perfected in New York City, and a membership of 527 reported. To its objects were added, at a meeting in Baltimore, Maryland, June 19, 1888, the securing of improvement in the condition of the public roads and highways. Since

the adoption of this clause the league has spent over \$120,000 to advance the cause of road improvement, and has published more than 2,000,000 pamphlets and magazines. It commenced an agitation which resulted in the construction of many miles of splendid roads in the Eastern states. It has also promoted the test of endurance in carrying military dispatches from San Francisco to New York, thus drawing attention to the condition of the Western roads, and it has become a political power in the interests of road improvements. (See **ROADS, MOVEMENT FOR GOOD**, in these supplements).

Divisions have been formed in every city of the Union, working in combination with the parent society. These undertake the issuance of road-books, tour-books, maps, directories and guides, supervise the amateur question at athletic meetings, and by means of chief consuls in each of the principal cities of the Union, watch over the interests of wheelmen, and, where necessary, defend them from unjust attacks. The rules require a member to be an amateur, white, and at least eighteen years of age.

The League has also made arrangements with one of the best hotels in nearly every town in the United States for reduced rates to touring members, frequently obtaining a reduction of thirty-five per cent. It assists in the recovery of stolen wheels by the offer of reward; publishes the *League of American Wheelmen Bulletin*, containing matters of interest to cyclists; and prosecutes persons injuring members when riding. The initiation fee is \$2, and a renewal of membership costs \$1 annually. The national secretary is Abbot Bassett, and the headquarters are at No. 12 Pearl Street, Boston, Mass.

**LEAN, MRS. (FLORENCE MARRYAT)**, an English novelist; born at Brighton, Sussex, England, in 1837; daughter of Captain Frederick Marryat. She was an operatic singer and comedy actress. She was married first to Ross Church and later to Francis Lean. She wrote *Love's Conflict* (1865); *Tom Tiddler's Ground* (1886); *A Fatal Silence* (1891); *The Hampstead Mystery* (1894); and a book dealing with Spiritualism, entitled *There is No Death* (1891). *The Risen Dead* appeared in 1893. She also contributed constantly to magazines, and in 1872 became editor of *London Society*. Died at London, Oct. 27, 1899.

**LEANING TOWERS.** See **PISA**, Vol. XIX, p. 122.

**LEAPING-FISH** (*Salarias tridactylus*), a curious little fish of the blenny family, abounding on the coast of Ceylon. It is very active, and makes leaps of several times its own length.

**LEATHER.** Knapp's process of tanning with ferric salts, and Dr. Heinzerling's method of quick tanning by means of chromates, with an addition of aluminium salts, chloride of sodium, etc., have received but little attention from practical tanners in America, although making some progress in Germany. In Sweden an electric tanning process, invented by J. D. Abom, has been tried successfully. Ox-hides suitable for sole-leather were hung in tanning liquor between two copper plates, which served

as the electrodes. An alternating current from a Siemens dynamo, having an electromotive force of fifty volts and a strength of one hundred amperes, was passed into these plates. The hides were completely tanned in from fifty to ninety hours, according to the strength of the tan-liquor employed. An electric tanning process of another inventor, who moves the hides mechanically during the operation of tanning, is said to be making progress in France. But there are no reliable statistics in either of these cases. Among tanners it is an accepted maxim that no time-abridging process can produce good sole-leather, because for the thorough tanning of thick hides a slowly operating influence, and therefore a long time, is necessary.

For the "imitation of French kid" the skins are stained on the grain side with a black, sometimes made by boiling together four ounces of pulverized nut-galls, and two ounces of blue vitriol in one gallon of logwood liquor, and afterward adding four quarts of vinegar saturated with iron. Several other kinds of black are employed. After being blacked by several successive applications of the liquor, the skins are dried, then oiled with sperm-oil and glazed two or three times, according to the brightness of the finish desired.

For the finishing of "brushed kid" the skins are blacked on the grain side with a preparation made by suspending five pounds of iron in twenty-five gallons of strong vinegar for four weeks, and then adding for each quart of this solution half a pint of bullock's blood, either warm or coagulated. After being blacked with this preparation the skins are made wet with gum-water and then brushed with a soft brush. Next they are scraped on the flesh side with a steel slicker, and oiled on the grain side with the best of sperm-oil.

For finishing "pebble-grained goat" and "straight-grained goat" the skins are seasoned and blacked with a preparation of bullock's blood, logwood, boiled milk, water and a small quantity of vinegar black. After hanging in the drying-loft overnight they are glazed, and then grained twice and oiled with sperm-oil. For "oiled goat" the skins also are blacked, and then stuffed on the flesh side with a dubbing composed of oil and tallow. After drying, the oiled skins are grained in various ways, then treated to a coat of dubbing on the grain side, which afterward is flattened down with a dull slicker, and lastly they are treated with a coat of fine sperm-oil.

Russia leather now is smeared over on the outside, while still damp, with a solution of oil of birch bark dissolved in a little alcohol and ether. See also **LEATHER**, Vol. XIV, pp. 380-391.

**LEATHER-BOARD**, an imitation of sole-leather, first manufactured in the United States. See **LEATHER, ARTIFICIAL**, Vol. XIV, p. 391.

**LEATHERWOOD** OR **MOOSEWOOD** (*Dica palustris*), a deciduous shrub three to six feet high, a native of North America. It belongs to the natural order *Thymelæacea*. The bark and wood are tough, and in Canada the bark is used for ropes, baskets, etc. The leaves are lanceolate-oblong; the flowers are yellow, and appear before the leaves.

**LEAVENWORTH**, a city, and the capital of Leavenworth County, northeastern Kansas, 20 miles N.W. of Kansas City. It is the oldest town in the state. Eight railroads converge here, and a splendid iron railway bridge crosses the river; the railroad systems include the Atchison, Topeka and Santa Fé, the Missouri Pacific, the Union Pacific, the Leavenworth, Topeka and Southwestern, the Kansas City, Northwestern and the Chicago, Rock Island and Pacific. Leavenworth has a fine park and ample water-supply, a good system of sewerage, street-railways, a telephone exchange, and is lighted with gas and electricity. Good bituminous coal is mined here, and fine building-stones are quarried. Among the thriving manufactures are flour, lumber, glucose, bricks, wagons, furniture, boots, shoes, boilers, engines, cigars, iron bridges, jewelry and machinery. The town was incorporated in 1856. The extensive military establishment of Fort Leavenworth adjoins the city on the north. Here also is located the state penitentiary. Population 1890, 19,768; 1900, 20,735. See also **LEAVENWORTH**, Vol. XIV, p. 391.

**LEAVITT**, JOSHUA, an American journalist; born at Heath, Massachusetts, in 1794. After practicing law at Putney, Vermont, for some years, he studied theology at New Haven, and was ordained pastor at Stratford, Connecticut, in 1825. In 1831 he founded the *New York Evangelist* to advocate the revival system in the Presbyterian Church. As he was also prominent in the antislavery agitation, he had but poor prospects in New York. In 1837 Leavitt became editor of *The Emancipator*, which he removed to Boston in 1841. From 1844 to 1847 he was chairman of the National Committee of the Liberty Party. In 1848 he became the managing editor of the *New York Independent*, and contributed to its pages for many years. He aided in founding and became secretary of the first temperance society in New York; as secretary of the American Seamen's Friend Association, established chapels in a great many ports in all parts of the world, and he was one of the abolitionists who were obliged to flee from Philadelphia to escape mob-violence. He died in Brooklyn, New York, in 1873.

**LEBANON**, a city of St. Clair County, southwestern Illinois, a summer resort for the people of St. Louis, from which city it is 23 miles E., on the Baltimore and Ohio Southwestern railroad. It is noted for its educational advantages, is the seat of McKendree College (Methodist), organized in 1828; has churches, mills, a machine-shop and various other manufactories, and has farming and coal-mining interests. Pop. 1890, 1,636; 1900, 1,812.

**LEBANON**, a city and the capital of Boone County, central Indiana, 26 miles N.W. of Indianapolis, on the Chicago and Southeastern and the Cleveland, Cincinnati, Chicago and St. Louis railroads. It has barrel and stave, refrigerator, washing-machine and furniture factories, a cooperage, grain-elevators, and flour, saw and planing mills. It is in a dairying region. Population 1890, 3,682.

**LEBANON**, a city and the capital of Marion County, central Kentucky, on the Louisville and

Nashville railroad, 55 miles S.E. of Louisville. It is a shipping-point for various adjoining counties, manufactures carriages, ice and furniture and whisky is distilled. Farms for the raising of thoroughbred horses are numerous in the vicinity. Timber is plentiful. A Baptist College for women is here, two Roman Catholic academies and a high school. Population 1890, 2,816.

**LEBANON**, a town and the capital of Laclede County, southern central Missouri, 67 miles S.S.W. of Jefferson City, on the St. Louis and San Francisco railroad. It is a business center for the surrounding fruit-raising region, contains an excellent seminary, and has considerable popularity as a health-resort, on account of its magnetic mineral springs, which have alkaline carbonated calcic-magnesian waters. Pop. 1890, 2,218; 1900, 2,125.

**LEBANON**, a town of Grafton County, southwestern New Hampshire, on the Mascoma River, four miles from White River Junction, Vermont, on the Boston and Maine railroad. It manufactures furniture, iron castings, elastic sponges, flannels, cloakings, shirts, overalls, underwear, machinery, watch-keys, wood-pulp and agricultural implements. West Lebanon, on the Connecticut River, is the seat of the Tilden Ladies' Seminary. The village is furnished with water-power by the Mascoma River, and the town has railroad-shops and various industries, and a public circulating library. Population 1890, 3,763; 1900, 4,965.

**LEBANON**, a post village and the capital of Warren County, southwestern Ohio, 30 miles N.E. of Cincinnati, on the Cincinnati, Lebanon and Northern and the Dayton, Lebanon and Cincinnati railroads. It has a national bank, the National Normal University, an opium-cure sanatorium, an orphans' home, a county infirmary and planing-mills. It has a reputation for the raising of Poland China hogs, which are said to have originally been bred here. Population 1890, 3,050; 1900, 2,867.

**LEBANON**, a city and the capital of Lebanon County, southeastern Pennsylvania, 24 miles E.N.E. of Harrisburg, on the Philadelphia and Reading, the Cornwall and the Cornwall and Lebanon railroads. In the vicinity are farms, anthracite coal-mines, iron-mines, limestone and brown sandstone quarries and brick-clay beds. It is engaged extensively in the working of iron; has rolling-mills, iron foundries and furnaces, machine-shops, stove-works, boiler, nut, bolt, chain and agricultural-implement works, and car, engine, rope, organ, soap, pottery and furniture factories. It has a widows' home, public libraries, gas and electric lights and electric street-railways. Population 1890, 14,664; 1900, 17,628.

**LEBANON**, a town and the capital of Wilson County, central Tennessee, 28 miles E. of Nashville, on the Nashville, Chattanooga and St. Louis and the Nashville and Knoxville railroads. It is in a rich wheat and corn region, hogs and mules are extensively raised in the neighborhood, and the town contains flour-mills, woolen-mills, barrel factories, and tobacco warehouses. It is the seat of Cumberland University, a Cumberland Presbyterian institution founded in 1842, which had 20 instructors, 225

students and 6,000 volumes in its library in 1896. Population 1890, 1,883; 1900, 1,956.

LEBANON SPRINGS, a post village and summer resort of Columbia County, northeastern New York, on the Lebanon Springs railroad. It contains a mineral spring whose waters possess curative qualities in certain diseases. The water is sufficiently abundant to furnish valuable motive power. Thermometers and pharmaceutical preparations are made in the vicinity. There are several Shaker communities near the village, and a hotel at which Lafayette was a guest. See MINERAL WATERS, Vol. XVI, p. 436.

LEBANON VALLEY COLLEGE, a co-educational institution located at Annville, Pennsylvania. It was organized in 1866 by the United Brethren. There are two courses, the classical and the scientific. The attendance averages about 115; there is a faculty of 10 members, and a library of 50,000 volumes. Besides its equipment on the campus, there is property amounting to \$22,000, which, with money from all other sources, brings an annual income of \$10,000.

LE BLANC, a thriving town of central France, in the department of the Indre, situated on the Creuse, near long. 1° W. Above Le Blanc the river expands so as to form a lake, but at the town it contracts and breaks into cascades with sufficient fall to turn the machinery of several manufactories. It has linen-yarn and cloth mills, potteries, tanneries, vinegar-works, forges, etc. It is very ancient, having been occupied by the Romans. Population, 6,000.

LEBRUN, CHARLES FRANÇOIS, a French statesman; born at St. Sauveur Landelin, March 19, 1739. He served as adviser to Maupeou before the accession of Louis XVI, after which he retired and applied himself to literature, and in 1789 attracted attention by his *La Voix des Citoyens*. He was a Deputy to the States General; imprisoned during the Reign of Terror; became president of the Council of Five Hundred in 1796; and third consul in 1799, with control of finances and internal administration. Under Napoleon he held various offices; was created Duke of Piaccenza; and in 1810 was appointed governor of Holland. After the first restoration he was made a peer of France by Louis XVIII, but after the second restoration was not allowed to take his seat in the Chamber of Peers until 1819. He died at St. Mesme, June 16, 1824.

LEBRUN, MARIE ANNE ÉLISABETH VIGÉE, a French painter; born in Paris, April 16, 1755. She began painting portraits while quite young; executed portraits of Marie Antoinette and others; was made a member of the Academy in 1783, and in the same year left France, traveling through Europe. She painted portraits of George IV, Lady Hamilton, Lord Byron, Napoleon's sister, Caroline Murat, and a great many other notable people of her time. Seven or eight of her most important pictures may be seen at the Louvre. She died March 30, 1842.

LEBRUN, PONCE DENIS ECONCHARD, a French epigrammatist. See EPIGRAMS, Vol. VIII, p. 478.

LECH, a river of Austria and Germany, rising in Voralberg, Tyrol, Bavaria and Augsburg and joining the Danube a few miles from Donauwörth. It is 140 miles long, but not navigable, and is used only

to float logs from Füssen. It was while defending the passage of this stream against Gustavus Adolphus that Tilly was killed.

LECKY, WILLIAM EDWARD HARTPOLE, an English philosophic historian, was born at Newton Park, near Dublin, March 26, 1838. He graduated at Trinity College, Dublin, in 1859, and in 1861 published, anonymously, *Leaders of Opinion in Ireland*, a series of brilliant essays on Swift, Flood, Grattan and O'Connell. The work was republished in 1871, when its authorship was acknowledged. In 1865 Lecky published (2 vols.) his learned work, *History of the Rise and Influence of the Spirit of Rationalism in Europe*, in which he sketched the decline of belief in witchcraft and miracles, and the rise of rationalistic thought in science, politics and morals. The work



WILLIAM E. H. LECKY.

won for him the reputation of being an acute thinker, as well as a profound scholar. This was followed, in 1869, by a *History of European Morals*, from Augustus to Charlemagne, embracing a study of the moral life of pagan and Christian Rome, with a chapter on the influence of Christianity on the position of women in Europe. His *Magnum Opus: A History of England in the Eighteenth Century* (8 vols.) appeared between the years 1878 and 1890, to which was added, in 1892, a *History of Ireland in the Eighteenth Century* (5 vols.). In this thoughtful, scholarly and luminous work, Mr. Lecky deals on a large scale with the chief events that have influenced political and religious progress and that enter into the thought and manners of the people. The Irish section is a dispassionate and consecutive narrative of Irish history from the period of the Tudor conquest to that of the Union. His historical reading made him a strong opponent of Mr. Gladstone's scheme of Home Rule. The author's latest work, *Democracy and Liberty* (2 vols., 1896), is a valuable dissertation, though rather pessimistic in tone, on the development of democracy, and its tendency to degrade political life and introduce the mechanical or material element into it, despite the checks and safeguards that conservative minds desire to throw around it. Two addresses by Mr. Lecky, delivered before institutes in England, have been separately published, one on *The Political Value of History* (1892) and the other on *The Empire: Its Value and Growth* (1893).

LECLANCHÉ CELL. See ELECTRICITY, § 104, in these Supplements.

LECLERC, VICTOR EMMANUEL, a French soldier; born near Paris, March 17, 1772. He joined the republican army in 1791; rose to the rank of brigadier-general in 1795; married a sister of Napoleon Bonaparte in 1797, and accompanied his brother-in-law to Egypt. He was at the head of the army sent against Portugal in 1801, and in the same year was sent to Santo Domingo to subdue the French

portion and capture the Spanish part. This he did, and sent the black leader, Toussaint l'Ouverture, prisoner to Paris. He died of fever at Cape Français, Dec. 2, 1802.

LECOQ, ALEXANDRE CHARLES, a French musician; born in Paris, June 3, 1832, and trained at the Conservatoire, where he afterward became a professor, and was acknowledged the worthy successor of Auber in comic opera. His best-known works are *La Fille de Madame Angot* (1872); *Giroflé-Girofla* (1874); *Le Petit Duc* (1878); *Fleur du Thé* (1868); *Janot* (1881); *La Volière* (1888); and *L'Egyptienne* (1890).

LECOMTE, LOUIS, a French priest; born at Bordeaux, France, 1655. He was sent to China with five other Jesuits, selected for their mathematical attainments. They carried on astronomical investigations for several years, learned the customs of the country, and did some missionary work. On his return he wrote a book called *Nouveaux Mémoires sur l'État Présent de la Chine* (1696-1701); and also *Sur les Cérémonies de la Chine* (1700). Both books were condemned by the Congregation at Rome. He died at Bordeaux in 1729.

LE CONTE, LEWIS, an American naturalist; born near Shrewsbury, New Jersey, Aug. 4, 1782. He was educated at Columbia College, and afterward studied medicine, but removed to Georgia, and never practiced. However, he kept up scientific study and investigation, especially in botany. He would not publish the results of his work, but gave them to friends and to his brother. He died in Liberty County, Georgia, Jan. 9, 1868.—His son, JOHN, a physicist, was born in Liberty County, Georgia, Dec. 4, 1818. He graduated at Franklin College, Athens, Georgia, in 1838, and in 1841 at the College of Physicians and Surgeons, New York. After practicing for some years as a physician at Savannah, he was made professor of natural philosophy in Franklin College in 1846, and in 1856 became professor of the same branch in South Carolina College at Columbia. In 1869 Le Conte was appointed professor of physics and industrial mechanics in the newly founded University of California, and in 1875 he became president of that university, but retired in 1881 to the chair of physics. His scientific work extended over nearly fifty years. He published important papers on physical science in many periodicals, both in America and in England, and delivered lectures on *The Physics of Meteorology* at the Smithsonian Institution, in Washington, District of Columbia (1857), and on *The Stellar Universe* at the Peabody Institution, in Baltimore, Maryland (1867). After 1867 Professor Le Conte was an active member of the National Academy of Science. Among his publications are *Study of the Physical Sciences* (1858); *The Nebular Hypothesis* (1873); *Sound-Shadows in Water* (1882); and *Vital Statistics, and the True Co-efficient of Mortality, Illustrated by Cancer* (1888). He died in Berkeley, California, April 29, 1891.—His brother, JOSEPH, an American geologist; born in Liberty County, Georgia, Feb. 26, 1823. After graduating at Franklin College, Athens, Georgia, and obtaining his

degree of M.D. at the College of Physicians and Surgeons in New York, he practiced as a physician at Macon, Georgia, for several years. In 1850 he entered the Lawrence Scientific School at Harvard, and studied natural history under Professor Louis Agassiz, accompanying the latter on an exploring expedition to Florida in 1851. In 1852 he was made professor of natural sciences in Oglethorpe College, and a year later in Franklin College. In 1857 he accepted the professorship of chemistry and geology in South Carolina College, and in 1869 he became professor of natural history and geology in the University of California. Besides many important scientific papers, Professor Le Conte has published essays on education and the fine arts, and the *Mutual Relations of Religion and Science; Elements of Geology; Light, the Principles of Monocular and Binocular Vision; and Evolution: Its Nature, Evidences and Its Relation to Religious Thought* (1887).—Lewis's

brother, JOHN EATON, an American naturalist; born near Shrewsbury, New Jersey. In 1818 he entered the corps of topographical engineers of the United States army, and remained in that service till 1831, taking part in various surveys. Having attained the rank of major, he retired from the service in the last-mentioned year, in order to devote himself to the study of botany and zoology. He published several papers on insects, such as *North American Butterflies* and some papers on mammals, reptiles, batrachians and crustacea. He died in Philadelphia, Nov. 21, 1860, leaving a considerable collection of insects and an extensive series of water-color illustrations of American insects and plants that he had made with his own hands. He published *Monographs of the North American Species Utricularia; Gratiola and Ruellia; Annals of the New York Lyceum of Natural History; and A Monograph of North American Histeroides*.—His son, JOHN LAWRENCE, an American naturalist; born in the city of New York, May 13, 1825. As a student at Mount St. Mary's College, Emmitsburg, Maryland, and at the College of Physicians and Surgeons, New York, he devoted considerable attention to the study of natural history, which he subsequently extended. He visited the Lake Superior region three times, the Rocky Mountains, California, New Mexico, Honduras, Panama, Europe, Egypt, Algiers, etc., collecting many specimens of insects, especially of the coleoptera, upon which he published several treatises. In 1862 he entered the United States army as a surgeon of volunteers. Afterward he was made medical inspector of the regular army, with the rank of lieutenant-colonel, which he retained until the end of the war. Then he became chief clerk of the United States mint at Philadelphia, and remained in this position until the time of his death. The Smithsonian Institution published his *Classifi-*



JOSEPH LE CONTE.

*cation of the Coleoptera of North America* and his *List of the Coleoptera of North America* (1862-73). He was a charter member of the National Academy of Sciences, and in 1873 was president of the American Association for the Advancement of Science. He died Nov. 15, 1883.

LECOUVREUR, ADRIENNE, a French actress; born at Danery, France, April 5, 1692. She died March 20, 1730. See SAXE, Vol. XXI, p. 346.

LEDA, myth. See CASTOR AND POLLUX, Vol. V, p. 199.

LEDÓCHOWSKI, MIECZYSLAW HALKA, COUNT DE, a Polish cardinal, was born at Gorki, in Russia, Oct. 29, 1822. He began his theological studies under the Lazarists in the College of St John, Warsaw, and at the age of 18 received the ecclesiastical tonsure and habit from the bishop of Sandomir. After some studies at Vienna he proceeded to Rome, where he joined the *Academia Ecclesiastica*; became domestic prelate and prothonotary apostolic; and also went as auditor of the nunciature to Lisbon, Rio de Janeiro, and Santiago de Chile. He was nominated archbishop of Thebes, *in partibus infidelium*, on his appointment in 1861 to the nunciature of Brussels, where he remained four years. In Jan., 1866, he was translated to the archbishopric of Gnesen and Posen, with the title of primate of Poland. In consequence of his resistance to the laws enacted in Prussia, he was, in 1874, cast into prison, and, while there, was proclaimed a cardinal by the Pope, in a secret consistory held in Rome in 1875. He was released from captivity in 1876, and went to Rome. He was made prefect of the Propaganda in 1892. Died in Lucerne Switzerland, July 28, 1894.

LEDUM, a genus of plants of the family *Ericacea*, consisting of small evergreen shrubs with large flowers, of which the corolla is cut into five deep segments. The species are natives of Europe and North America, and are commonly known as Labrador tea. Sir John Franklin and his party, in the Arctic expedition of 1819-22, are said to have used the *Ledum palustre* for tea. The leaves possess narcotic properties, and are regarded as useful in agues, dysentery and diarrhoea. The common species of the United States is *L. latifolium*.

LEE, a town of central Berkshire County, Massachusetts, on the Housatonic River and railroad, 11 miles S. of Pittsfield. It has a public library, excellent schools, a number of paper-mills, several iron foundries and machine-shops, and extensive woolen factories. The township is noted for its quarries of fine white marble, which is exported to distant cities. Population 1900, 3,506.

LEE, ALFRED, an American bishop; born in Cambridge, Massachusetts, Sept. 9, 1807. He graduated at Harvard; practiced law in New London, Connecticut, until 1833, when he began to study for the ministry in the General Theological Seminary in New York; deacon of the Protestant Episcopal Church (1838), bishop of Delaware and rector of St. Andrew's, Wilmington (1841). In 1884 he became presiding bishop of the church in the United States. He wrote *Life of St. Peter* (1852); *Life of St. John* (1854); *Harbinger of Christ* (1857);

and *Eventful Nights in Bible History* (1886). He died in Wilmington, Delaware, April 12, 1887.

LEE, ANN (1736-84), the founder of the sect of of Shakers. See SHAKERS, Vol. XXI, p. 736.

LEE, ARTHUR, an American statesman and diplomatist; born at Stratford, Westmoreland County, Virginia, Dec. 20, 1740. Having been educated at Eton, England, he studied medicine at Edinburgh University, returning to America after graduation, and beginning practice as a physician in Williamsburg, Virginia. After a few years he went to London to study law, where he was admitted to the bar in 1770, in the same year being appointed agent for Massachusetts Bay Colony in London, in company with Franklin. In 1774 Lee presented to the British ministry the addresses of the American Congress to the people and King of England. In 1776 he was American commissioner in Paris, and with Franklin and Silas Deane secured a treaty of alliance with the French. In 1777 he was sent to Spain and afterward to Prussia to enlist sympathy for the American cause. After serving in Congress in 1782, he was, in 1784, made one of the commissioners to negotiate treaties with the Indians of the Northwest, and was from 1785 to 1789 a member of the Board of Treasury. He died at Urbana, Middlesex County, Virginia, Dec. 12, 1792.

LEE, CHARLES, a British soldier; born at Dernhall, Cheshire, England, in 1731. His early education, in England and on the Continent, revealed a proficiency in languages which, during his subsequent rambles in Europe, was of great service to him. He early developed a taste for military affairs, and in 1751 received a lieutenant's commission in the Forty-fourth Regiment, shortly ordered to join General Braddock in America, in the disastrous expedition to Fort Duquesne. He entered with spirit into the campaigns which marked the French and Indian war, being wounded during the futile attack on Fort Ticonderoga in 1758. In 1760 the regiment to which he was attached joined General Amherst's forces in the assault and capture of Montreal. In 1762, Lee having returned to England, the scene of his military service was transferred to Portugal, where he aided efficiently in repelling the Spanish invasion. Shortly after this he turned his restless thoughts to schemes of colonization in America, but estranged the parties upon whose approval success depended, by his arrogant and ungovernable temper—a trait already unhappily apparent, and destined to prove at least the proximate cause of his ultimate downfall. Failing in efforts looking to his advancement at home, he speedily sought and obtained a staff appointment in Poland, a few years later receiving a major-general's commission in the Polish army. During this eventful period of his life his experience may be well styled that of an adventurer, subject to all the vicissitudes incident to such a career. One characteristic, however, had become pronounced, through indulgence as well as natural proclivity,—an overweening vanity, with insatiable ambition. Embittered by defeat in his cherished projects in England, he turned his attention to America a few years previous to the Revolution, arriving in New York during the agitation just pre-



ceding the outbreak of hostilities. Of his services to the American cause at this time, as is true of the early military career of Benedict Arnold, only praise can be recorded. Whatever his secret motives, his patriotic utterances could but elicit the favor of the Continental Congress and popular admiration. With the movements of the army besieging Boston in 1775, and the appointment of Washington as commander-in-chief, the first intimations of Lee's designs become manifest. Though he fought bravely at Bunker Hill, it was evident that his animosity toward Washington was deep-seated. During Moultrie's repulse of Clinton in 1776, and in the campaign preceding the occupation of the Jerseys, Lee's self-love and temper were frequently displayed. On attaining the position of ranking major-general his purpose of self-advancement received such encouragement that he ventured to disobey the orders of his commander in the campaign which followed the evacuation of New York. Only when the American position had become so hazardous as to compel Washington to cross the Delaware was the traitorous design of Lee thwarted, by his capture while distant four miles from the army upon which Washington had placed every reliance. It was during Lee's imprisonment in New York that the incriminating correspondence with the Howes occurred, which, first made known to the world in 1857, has fully revealed the treasonable conduct of the pretended patriot. Inscrutable as appears his reinstatement upon his exchange, Lee rejoined Washington at Valley Forge, and had early opportunity to gratify his hatred in the campaign which culminated in the battle of Monmouth. Lee's behavior during that memorable conflict, when the American forces were saved from utter route only by Washington's presence of mind, cannot be extenuated. Of Lee's dilatory movements in checking the onslaught of the British rear-guard, easily dispersed by Washington later in the day, there is but one possible explanation; and for Washington's conviction, as manifested in his scathing rebuke to Lee upon the field, there is every justification; and we have Lafayette's testimony that the commander's speech was suitable to the occasion rather than to wonted etiquette. Afterwards ordered to the rear, there followed his arrest, court-martial, and conviction, evoking the insults to Washington which led to his duel with Colonel Laurens, in which he was wounded, and finally to the letter libeling the Continental Congress, which resulted in his dismissal from the army. At his estate in the Shenandoah valley Lee wore away the remainder of his life in solitude and disgrace, dying miserably in a tavern, in Philadelphia, Oct. 2, 1782.

LEE, FITZHUGH, an American soldier; born in Fairfax County, Va., Nov. 10, 1835; graduated at West Point, but withdrew from the Union army and joined the Confederate forces, wherein he rose to the rank of major-general. From 1886 to 1890 he was governor of Virginia, and in the spring of 1896 he was appointed United States consul-general at Havana. In this position General Lee did signal service, not only keeping the State Department thoroughly informed as to Spanish policy and movements in the matter of the rebellion, but also upholding American

rights and interests with a vigor that won applause at home and respect in Havana and Madrid. During the trying period between the destruction of the *Maine* and his withdrawal from Havana on the 9th of April, 1898, his tact did much to avert the premature outbreak of war and to protect American life and property. Shortly after his return to the United States he was appointed (May 16) to the command of the Seventh Corps at Tampa, Fla. On the 13th of December he was appointed military governor of the province of Havana, and on the formal cession of Cuba on the 1st of January, 1899, he assumed the duties of his office.



FITZHUGH LEE.

LEE, FRANCIS LIGHTFOOT, an American statesman; born at Stratford, Westmoreland County, Va., Oct. 14, 1734. In 1765 he was elected to the House of Burgesses, and in 1775 was sent to Congress. Here he signed the Declaration of Independence and assisted in framing the Articles of Confederation. He died at Richmond, Va., April 3, 1797.

LEE, FREDERICK RICHARD, an English landscape painter; born at Barnstaple, Devonshire, in June, 1798. He chose a military career, but was obliged by ill health to quit it. He then turned his attention to painting, was an exhibitor at the Royal Academy from 1824 till 1870, and acquired a high reputation for landscapes, especially of English and Scotch scenery. He was elected an associate in 1834, and in 1838 a member of the Royal Academy, retiring in 1871. He died at Cape Town, South Africa, June 4, 1879.

LEE, HENRY, an American soldier; born at Stratford, Va., Jan. 29, 1756. In 1776 he became captain of cavalry, and in 1778 commanded an independent corps, with the rank of major, being popularly known as "Light-Horse Harry." In 1779 he received a gold medal from Congress for capturing Paulus Hook. He assisted Greene in the capture of Augusta, Ga., and took part in the battle of Eutaw Springs. After being a member of Congress, he was, in 1792, chosen governor of Virginia; and in 1794 he commanded the force sent by Washington to suppress the whisky insurrection in Pennsylvania. When Washington died, Lee, then again in Congress, pronounced his eulogy, and drafted the resolutions designating Washington as "first in war, first in peace, and first in the hearts of his countrymen." After Jefferson's election Lee retired from public life. He became involved in debt, and was confined in Spottsylvania County, during which time he wrote *Memoirs of the War in the Southern Department of the United States*. While returning from a health trip to the West Indies he died at Cumberland Island, March 25, 1818. He was the father of ROBERT E. LEE, q. v., Vol. XIV, p. 390.

LEE, LUTHER, an American clergyman; born at Schoharie, N. Y., Nov. 30, 1800. He became a preacher in the Methodist Episcopal Church in 1821.

In 1836 he began to preach and lecture against slavery, and was several times attacked by mobs. In 1841 he founded and edited the *New England Christian Advocate*, an antislavery journal, at Lowell, Massachusetts, and subsequently he edited *The Sword of Truth* and *The True Wesleyan*. When, in 1843, the "Wesleyan Methodist Connection" was organized he became a pastor of that church at Syracuse, New York, and afterward at Fulton, New York. In 1856, Lee became president and professor of theology in the Michigan Union College at Seoni, but resigned the next year to officiate in churches in Ohio. From 1864 till 1867 he was professor at Adrian College, Michigan, and then returned to the Detroit conference in 1867. He was the author of *Universalism Refuted; Immortality of the Soul; Church Polity: Slavery Examined in the Light of the Bible* (1855); and *Elements of Theology*. He died at Flint, Michigan, Dec. 13, 1889.

LEE, ROBERT, a British divine and author; born at Tweedmouth, England, Nov. 11, 1804. After graduating at the University of St. Andrews he was ordained in the Church of Scotland in 1832. He became successively minister of Arbroath, Campsie and Old Grey Friars' Church in Edinburgh. In 1846, Lee was made professor of Biblical criticism in the University of Edinburgh. In 1857 he published *Prayers for Public Worship*, and used these prayers in his congregation. For this he was tried in the church courts and acquitted in 1864. Afterward he published *The Reform of the Church of Scotland in Worship, Government and Doctrine*, and introduced an organ in his church in 1865. For this innovation he was again tried, in both the ecclesiastical and civil courts. His most important work was a *Reference Bible* (1864), having about 60,000 references. He died at Torquay, March 14, 1868.

LEE, SAMUEL, an English Orientalist; born at Longnor, in Shropshire, May 14, 1783. He received his first instruction at a charity school, and at the age of 12 was apprenticed to a carpenter. While engaged at his trade he acquired the chief classical, Oriental and modern languages, subsequently studied at Queen's College, Cambridge, and took orders in the church. In 1819 he became university professor of Arabic, and in 1831 regius professor of Hebrew. He published several works on Biblical and linguistic subjects, among them being a *Hebrew Grammar* (1830); *Translations of The Travels of Ibn Batuta* (1833); and *Hebrew and English Lexicon* (1840). He died at Barley, Hertfordshire, Dec. 16, 1852.

LEE, WILLIAM HENRY FITZBUGH, an American soldier, second son of Gen. R. E. Lee; born at Arlington, Virginia, May 31, 1837; appointed lieutenant in the United States army in 1857, and served in the Utah campaign. In 1861 he joined the Confederate forces, became a brigadier-general in October, 1862, was captured and exchanged, and in April, 1864, as a major-general of cavalry, led his division from the Rapidan to Appomattox. In 1886 he was elected to Congress, and twice re-elected. He died at Ravensworth, Virginia, Oct. 15, 1891.

LEECHBURG, a post borough of Armstrong

County, central western Pennsylvania, on the Pennsylvania railroad, the Pennsylvania canal, and the Conemaugh River, 35 miles N.E. of Pittsburg. It is in a coal and natural-gas region, and has an academy, a wagon and carriage manufactory, tin factory and rolling-mill, all of which use natural gas for fuel. Population 1890, 1,921; 1900, 2,459.

LEECH LAKE, a lake about twenty miles long and sixteen miles wide, in the northern part of Minnesota, about seven miles south of Lake Cass. Its surplus water is discharged by a short outlet into the Mississippi River. It is in a heavily timbered region inhabited by Chippewa Indians. Elevation, 1,330 feet.

LEESBURG, a town and the capital of Loudoun County, northern Virginia, 36 miles N.W. of Washington, District of Columbia, on the Potomac River, and on the Southern railroad. It contains a seminary for young men and Leesburg Female Institute. It is in an agricultural region. The town has an abundant water-supply and electric lights and has saw and planing mills. The battle of Ball's Bluff was fought two miles from the town. Population 1900, 1,513.

LEESER, ISAAC, an American divine; born in Neukirchen, Westphalia, Dec. 12, 1806. After being engaged in commerce for a number of years he entered the Jewish ministry in 1829, as rabbi of the principal synagogue in Philadelphia. Among other works relating to the Jews, he has written *The Jews and the Mosaic Law* (1833); *Discourses on the Subject of Jewish Religion* (1836); and a translation of the Holy Scriptures from the original Hebrew (1845-53). He also established a magazine, *The Occident and American Jewish Advocate* (1843). His life was largely devoted to educational and charitable interests, which entitled him to universal esteem. His death occurred in Philadelphia, Feb. 1, 1868.

LEETONIA, a post village and a railroad junction of Columbiana County, central eastern Ohio, 65 miles N.W. of Pittsburg, on the New York, Lake Erie and Western and the Pittsburg, Fort Wayne and Chicago railroads. It has rolling and planing mills, coal-mines, coke-ovens, blast-furnaces, boiler-works, a nail and bolt mill, a foundry and lumber-yards. Population 1900, 2,744.

LEEWARD ISLANDS. See TAHITI ARCHIPELAGO, Vol. XXIII, p. 22; and WEST INDIES, Vol. XXIV, p. 510.

LEFEBVRE, FRANÇOIS JOSEPH, a French soldier; born at Ruffach, Alsace, Oct. 25, 1755; entered the French army in 1773; rose rapidly in the service, and became a brigadier-general in 1794; supported Napoleon, and was made a marshal upon the establishment of the empire. His distinguished bravery at the siege of Dantzic in 1807 was rewarded with the title of Duke of Dantzic; took Bilbao and defeated the British in Spain in 1808. He served in the Napoleonic campaigns, and commanded the left wing of Bonaparte's army in 1814, but surrendered upon the Bourbon restoration, being created a peer of France. He died in Paris, Sept. 14, 1820.

LEFEBVRE, JULES JOSEPH, a French painter of note; born at Tournay, March 10, 1836; was a pupil

of Léon Cogniet; gained the *grand prix de Rome* in 1861 by his painting, *The Death of Priam*. His first Salon picture, was a portrait (1855); afterward a frequent exhibitor; among his more prominent works being *Roman Charity* (1864); *Nymph and Bacchus* (1867); *Truth* (1870); *Madeleine* (1876); *Pandora* (1877); *Mignon* (1878); *Psyche* (1883); *Lady Godiva* (1890); and *A Daughter of Eve* (1892). He obtained three medals, in 1885, 1888 and 1870; medal of the first class at the Exposition Universelle (1878); medal of honor (1886); grand prize at the exposition of 1889; chosen member of the Academy of Fine Arts (1891); decorated with the Legion of Honor (1870); and made an officer of the same (1878). He excels in the portrayal of the nude, and his subjects are often allegorical or drawn from Greek and Roman mythology.

LEFÉVRE, TANNÉGUL. See DACIER, Vol. VI, p. 759.

LEFEBVRE—DESNOUETTES, CHARLES, COMTE DE, a French general; born in Paris, Sept. 14, 1775. He entered the army, rising rapidly until 1808, when he became general of division; fought in all the campaigns of Napoleon, and was made a peer of France by him in 1815. When the Bourbons regained their power he was condemned to death, but escaped to the United States, where he carried on several schemes to liberate Napoleon, and for the founding of a French colony in Alabama. In his will Napoleon left him \$30,000. He was lost at sea, near Kinsale, Ireland, while returning to France, April 22, 1822.

LEFKOSIA, ancient capital. See CYPRUS, Vol. VI, p. 748; NICOSIA, Vol. XVII, p. 491; and in these Supplements.

LEGACY, a gift of personal property made by last will and testament. It may consist of a bequest of money, which is sometimes made a charge upon real estate. A legacy may be absolute and unconditional, or it may be subject to the happening of some uncertain event or condition. It may also be general, in which case it is made without reference to any particular property of the testator, as in the case of the general bequest of money which may be derived out of any of the estate; or specific, in which case it consists of a specified portion of the testator's personal estate, as distinguished from the remainder of the estate. A residuary legacy is a bequest of residue of the testator's personal estate after other interests are ascertained. A legacy is said to lapse when the legatee or beneficiary thereof dies before the death of the testator, in which case the interest does not become vested in him. Any person who is not an alien enemy or under statutory disability may become a legatee; but in some cases a legacy to one who is a subscribing witness to the will is held void. In both England and the United States legacies to charitable or other public institutions are favored by the courts, and frequently legacies of this class are sustained when they would in other cases be void for uncertainty. See also WILL, Vol. XXIV, pp. 570-574.

LEGAL EDUCATION IN THE UNITED STATES. The American lawyer receives his education in two ways,—by study in the office of a prac-

ticing attorney, and by attendance upon the lectures of a law school. To treat definitely and concisely of the former method is almost an impossibility. Until comparatively recent times, colleges where legal instruction was given in regular class-work were unknown. The early American lawyers were men educated in the offices of the attorneys and barristers. The first regular university instruction in common law was given by Blackstone, at Oxford, England, in 1758. With his appointment to the chair of English law began the agitation for separate law departments of instruction, which resulted, in America, in the establishment, in 1779, at the College of William and Mary, in Virginia, of such a school. Later, in the same year, lectures were given in law at Harvard College. In 1790 the University of Pennsylvania founded a chair of law, of which James Wilson was the first occupant. The first American law school distinct from a college was opened at Litchfield, Connecticut, in 1784. These schools were the result of overcrowded law-offices, and to no small extent was their establishment incited by the publication of *Blackstone's Commentaries* which furnished a text-book, hitherto a desired but unknown means of studying English law. The number of law schools in the United States increased from year to year, until in 1895 there were in operation 67 recognized colleges giving instruction in the various branches of jurisprudence. In the early years of these institutions the instruction given supplemented the office-practice, which was continued along with the lectures. In the beginning the lecture system was the only practical plan of instruction, owing to the temporary and limited employment of instructors. With the growth of the schools, methods and systems have sprung up almost equaling in number the schools themselves. These various methods may be classed as three: 1. Instruction by lectures; 2. Instruction by recitations upon lessons previously assigned; 3. Instruction by the presentation and study of leading cases. The last method is practiced in but three colleges,—Harvard University, Massachusetts; Metropolis Law School, New York; and Western Reserve University, Ohio. Of the 67 schools existing in 1895, 33 could be placed in the first class and 24 in the second. In some the two systems are combined, with the principal attention given to lectures. To take the place of the practice formerly obtained in the attorney's office, many of the schools conduct, as part of the curriculum, a moot court, in which the actual work of the regular court is carried on by the students. An agitation similar to that which, about 1890, modified the medical schools of the United States, and which was based upon an elevation of the entrance requirements, is necessary to place the law schools where they will relieve the country of a surplus of half-educated practitioners. An extended investigation of the entrance requirements of the various schools reveals a condition of affairs most deplorable. While some schools, by their high standards and rigid examinations, give hope of a future development, yet the laxity of the great majority gives an easy explanation of the low standards of the legal profession, so far as education is concerned.

The man whose preparation is such that he would be refused admission to the schools of any of the other professions is permitted to enter the law without objection. Almost without exception, the law schools require that an applicant for admission shall have read *Blackston's Commentaries*, and yet many of those schools do not require the student to have sufficient knowledge to understand what he has read. In some states, laws have been passed which, to some extent, remedy the evils of the college system. In many states it is seriously debated whether it would not be advisable to require all law students to first take collegiate courses. The necessity of a grasp of general law, and not merely a technical understanding of a few principles connected with the studies taught in the average law school, is doubted by no one. As Roman law is recognized as the foundation of all law, it is indispensable that the law student should make a study of the essential principles of that ancient code, many of which are used in practice, unchanged, in the American and English courts. So, too, with international law, which is looked upon as a distinct branch of law, and an understanding of which is an essential in the well equipped. That the reform movement in legal education will cause the trustees of law schools to make such studies as the two just mentioned a part of the required course, is no longer a matter of conjecture. It is a certainty. In a number of law schools, which are maintained as parts of great universities, the students are required to attend the collegiate classes in taxation, political economy, international law and Roman law. In others, the option of so doing is given the students. According to the report of the United States Commissioner of Education for 1894, the proportion of law students who have first graduated from a collegiate institution is surprisingly small. Then there were in attendance at the various colleges 8,644 students, of whom but 1,783 were the possessors of college degrees. That the collegiate course is a benefit, and is recognized as such by the law-makers of the various states, is evident from the answers received by the Committee on Legal Education of the American Bar Association to questions sent to the various states, and embodied in the report of that committee at the Bar Association meeting in 1891. In answer to the question, "Does the law of your state require students to read for any specified time before applying for admission to the bar?" the following states returned a negative: Alabama, Arkansas, California, Florida, Georgia, Michigan, Mississippi, Missouri, Nevada, New Hampshire, North Carolina, South Carolina, Tennessee and West Virginia. The matter was reported to be regulated by the courts as follows: In Connecticut the candidate must be at least 18 years of age, must read in an office three years, unless a college graduate, when two years is sufficient, and one year must be in the state; in Illinois, two years of study required, unless the applicant is a graduate of one of the law schools of the state, or has a license to practice in another state; in New York, three years in an office, two for college graduates, two years at a law school being equivalent to two of these required years, except to college graduates, who can count this period as equivalent

to one year; in Oregon, two years of study in an office required of a college graduate, and three years of all others; in Pennsylvania, two years' study in an office, subject to county court regulations; in Rhode Island, two years in a law school or in an office, but six months' study, in either case, must be in an office within the state. In other states the period prescribed by statute is as follows: In Colorado, two consecutive years of study; in the Dakotas, two years in an office or in some law school of the United States, or partly in either; in Delaware, either three years of office study, with a preliminary examination, or a diploma from a law school; in Louisiana, two years in an office, or graduation from some law school of the state; in Maryland, two years of office study; in Minnesota, two years in an office, graduates of the University of Minnesota Law Department being admitted on their diplomas; in Montana, two years of office study; in Nebraska, two years in office of an attorney; in New Jersey, four years in an office, unless a college graduate, of whom but three years are required, a year and a half in a law school being equivalent to same amount of time in an office; in Ohio, two years of office study; in Vermont, three years in an office required of all but graduates of law schools, who are admitted by examination; in Wisconsin, two years of office study are required; in Wyoming, two years of office study, the last of which must be in the state. It might be well to add, as to the power of inferior courts to admit persons to the bar, that negative answers were received from 17 states,—Colorado, Connecticut, Illinois, Louisiana, Montana, Nevada, New Hampshire, New Jersey, New York, North Carolina, Ohio, Oregon, Rhode Island, South Carolina, Vermont, Virginia, Wisconsin.

In the majority of law schools the course of study covers a period of two years, in a few three years, and in eight instances but one year. It is the tendency to increase the length of the course. The degree generally conferred is that of bachelor of laws. Many institutions offer an additional year for graduate study, upon the completion of which the degree of master of laws is conferred. The question of the entrance of women into the legal profession for a time stirred law school authorities. Women have not, however, sought admission in any considerable number, as, in 1894, of 7,311 students registered, only 54 were women. In 1890 there were but 4,518 students enrolled in law schools; in 1895 there were 8,644. In 1890, to a total population in the United States of 62,622,250, there were 87,422 practicing lawyers. The following table will show the number and location of the various law schools, together with the number of students and instructors in each, and the number of collegiate graduates. Where a law school is a department of a university, the university name is given, and not the distinctive college name. The statistics are for 1893-94, and were obtained from the United States Commissioner of Education. Two schools, Indian Central Normal College, and the American Temperance University at Harriman, Tennessee, are not included in the list, as no information was received regarding them.

LOCATION.	NAME OF INSTITUTION.	INSTRUCTORS.	STU- DENTS.		LENGTH OF COURSE.
			Total.	Having Degrees.	
University, Ala ----	Univ. of Alabama ---	3	18	--	2
Little Rock, Ark ----	Ark. Industrial Univ.	6	31	4	2
Palo Alto, Cal -----	Leland Stanford Jr. University -----	3	65	3	4
San Francisco, Cal -	Univ. of California ---	3	138	15	3
Boulder, Col-----	Univ. of Colorado ---	20	28	1	2
Denver, Col-----	Univ. of Denver-----	14	67	3	2
New Haven, Conn --	Yale University -----	32	188	--	2
Washington, D.C ---	Columbian Univ. ---	12	328	--	2
Washington, D.C ---	Howard University --	6	48	7	2
Washington, D.C ---	National University -	10	96	--	2
Washington, D.C ---	Georgetown Univ. ---	14	267	24	2
Athens, Ga -----	University of Georgia	10	21	6	1
Atlanta, Ga-----	Atlanta Law School--	5	7	--	2
Macon, Ga -----	Mercer University ---	4	14	--	1
Bloomington, Ill ---	Bloomington LawSch.	8	72	39	2
Chicago, Ill-----	Kent Law School ---	10	163	27	2
Chicago, Ill-----	Northwestern Univ.	12	140	20	2
Lebanon, Ill-----	McKendree College--	9	27	--	2
Quincy, Ill-----	Chaddock Sch. of Law	4	8	--	2
Bloomington, Ind ---	Indiana University ---	2	66	3	2
Notre Dame, Ind ---	Univ. of Notre Dame	9	46	5	2
Des Moines, Ia-----	Drake University ---	14	63	6	2
Iowa City, Ia-----	State Univ. of Iowa--	9	103	47	2
Lawrence, Kan-----	Univ. of Kansas-----	7	79	--	2
Louisville, Ky ----	Univ. of Louisville ---	3	48	--	2
New Orleans, La ---	Tulane University ---	5	75	4	2
Baltimore, Md-----	Univ. of Maryland ---	9	156	62	2
Baltimore, Md-----	Baltimore University	5	76	--	2
Boston, Mass-----	Boston University ---	24	258	69	2
Cambridge, Mass ---	Harvard University ---	11	353	--	2
Ann Arbor, Mich ---	Univ. of Michigan ---	22	607	--	2
Detroit, Mich-----	Detroit Col. of Law--	17	61	--	2
Minneapolis, Minn --	Univ. of Minnesota--	18	315	18	2
University, Miss ---	Univ. of Mississippi -	5	20	--	2
Columbia, Mo-----	Univ. of Missouri ---	9	77	3	2
St. Louis, Mo-----	Washington Univ. ---	14	99	--	2
Lincoln, Neb-----	Univ. of Nebraska ---	13	65	--	2
Albany, N.Y-----	Albany Law School--	7	43	12	1
Buffalo, N.Y-----	Niagara University --	26	50	14	2
Ithaca, N.Y-----	Cornell University ---	10	229	--	2
New York, N.Y-----	Univ. of the City of N.Y.	11	251	21	2
New York, N.Y-----	New York Law School	11	503	203	2
New York, N.Y-----	Columbia College ---	16	270	--	3
New York, N.Y-----	Metropolis Law School	10	162	34	2
Chapel Hill, N.C ---	Univ. of N. Carolina-	4	66	24	2
Raleigh, N.C-----	Shaw University ---	2	10	4	3
Ada, O-----	Ohio Normal Univ. ---	2	74	21	2
Cincinnati, O-----	Cincinnati College--	5	158	25	2
Cleveland, O-----	Western Reserve Univ.	14	34	10	2
Columbus, O-----	Ohio State University	11	72	6	2
Lebanon, O-----	National Normal Univ.	8	22	4	2
Portland, Or-----	University of Oregon -	4	76	3	2
Salem, Or-----	Willamette University	14	7	2	2
Carlisle, Pa-----	Dickinson Sch. of Law	13	54	4	2
Philadelphia, Pa ---	Univ. of Pennsylvania	7	236	--	3
Columbia, S.C-----	Univ. of S. Carolina-	1	6	--	2
Knoxville, Tenn ---	Tennessee University	5	19	2	2
Lebanon, Tenn-----	Cumberland Univ. ---	2	74	--	1
Nashville, Tenn ---	Cent. Tennessee Col.	5	10	--	2
Nashville, Tenn ---	Vanderbilt University	3	30	--	2
Sewanee, Tenn-----	Univ. of the South --	4	12	1	2
Austin, Tex-----	University of Texas --	4	108	--	2
Lexington, Va-----	Washington and Lee University -----	2	62	--	1
Richmond, Va-----	Richmond College--	1	28	--	2
Univ. of Virginia, Va	Univ. of Virginia ---	4	140	28	2
Morgantown, W. Va.	West Virginia Univ. -	2	47	10	2
Madison, Wis-----	Univ. of Wisconsin--	6	163	22	2

public or private, and will constitute a legal tender in any quantity. The standard silver dollar, is a legal tender for all debts, public and private, except when otherwise stipulated in the contract, and fractional silver coins, consisting of those coins of smaller denominations than one dollar, are a legal tender for all debts, public and private, in amounts not exceeding ten dollars, but such fractional coins may be exchanged for legal-tender money at the United States Treasury in sums of twenty dollars and multiples thereof. United States Treasury notes are legal tender for the payment of all debts, public and private, except for duties on imports and interest on the public debt, and except when otherwise expressly provided in the contract. Certificates issued upon the deposit of gold or silver coin in the Treasury of the United States are receivable for all customs, taxes and public dues, and may be redeemed in the coin which they represent, at the option of the holder. National bank notes constitute a legal tender for taxes and excises, and all other dues to the United States, except duties on imports, and also for all salaries and other debts and demands owing by the United States to individuals, corporations and associations within the United States, except interest on the public debt. The minor coins, consisting of a five-cent piece, a three-cent piece and a one-cent piece, are a legal tender for any amount not exceeding twenty-five cents. The coinage of the three-cent piece has been discontinued. Trade dollars, which consisted of 420 grains of silver, are no longer legal tender. Foreign gold and silver coins are not legal-tender money in the United States. Acts of Congress as to the legal tender of money have been held by the supreme court of the United States to be constitutional, as applied to pre-existing contracts, as well as to those made after the passage thereof. See also *Tender*, under PAYMENT, Vol. XVIII, p. 441.

LE GALLIENNE, RICHARD, poet, journalist, and critic, was born at Liverpool, Eng., Jan. 20, 1806, of a Guernsey family. In 1891 he devoted himself to journalism, being connected with the *London Star*, *Chronicle*, and *The Speaker*, and is a current contributor to the leading English monthlies and reviews. He has also lectured largely, and in that capacity paid a visit in 1898 to the United States. His published works include *My Ladies' Sonnets*, *Some Characteristics of George Meredith*, *English Poems*, *The Religion of a Literary Man*, *R. L. Stevenson, an Elegy and Other Poems*, *Prose Fancies*, a paraphrase of the *Rubaiyat of Omar Khayyam*, *Retrospective Reviews*, *The Quest of the Golden Girl*, and *If I Were God*. *The Romance of Zion Chapel*, *Young Lives*; also an edition of *The Compleat Angler* of Isaak Walton.

LEGARÉ, HUGH SWINSON, an American statesman; born at Charleston, South Carolina, Jan. 2, 1789, of Huguenot and Scotch descent. Upon graduating from the College of South Carolina in 1814, he studied law, traveled abroad, and on his return to Charleston was chosen to the state legislature (1820), serving again (1824-30), and was attorney-general of South Carolina in 1830. At the same time he became chief editor of the *Southern Review*.

LEGAL TENDER. Under the laws of the United States, the gold coins of the United States are legal tender for their face value for any debt.

In 1832 he became *chargé d'affaires* at Brussels. In 1837 he entered Congress, but, although holding a high place in debate, his financial views dissatisfied his constituents and he failed of re-election. During the Presidential canvass of 1840 he contributed a series of notable papers to the *New York Review* touching ancient democracy and Roman law. In 1841 President Tyler nominated him for Attorney-General of the United States, and when Daniel Webster withdrew from the Cabinet in May, 1843, Legaré was appointed to fill the vacancy of Secretary of State. He died suddenly in Boston, on June 2, 1843, while attending, with President Tyler, the ceremonies at the unveiling of the Bunker Hill Monument.

LEGER, PAUL LOUIS, a French writer, born in Toulouse, France, Jan. 13, 1843. He has given his time to the history and philology of the Slav peoples, traveling all through Europe several times and learning nearly all the European languages. In 1860 he lectured at the Sorbonne; in 1871, he became professor of Oriental languages in the *École Spéciale des Langues Orientales*, and in 1885 professor of Slav languages and literature in the *Collège de France*. Among his works appear *Études Slaves* (1875); *Nouvelles Études Slaves* (1880); *La Bulgarie* (1885); *Histoire de l'Autriche-Hongrie* (1878); and *La Littérature Russe* (1892).

LEGGIE, JAMES, a Scotch sinologue; born at Huntley, Aberdeenshire, Dec. 20, 1815. After studying theology at Highbury College, London, he was, in 1830, sent by the London Missionary Society to take charge of the Anglo-Chinese College at Malacca and in 1843 removed to Hong Kong, where he performed the functions of a missionary for thirty years. In 1875 Dr. Legge was made professor of the Chinese language at Oxford; he wrote a book on *The Notions of the Chinese Concerning God and Spirits*, in order to determine the controversy about the proper term for the Supreme Being in Chinese. His most important literary undertaking was his edition of the *Chinese Classics*, giving the original text, English translation, explanatory notes and copious prolegomena. He died at Oxford, Nov. 29, 1897.

LEGOUVÉ, GABRIEL JEAN BAPTISTE ERNEST WILFRID, a voluminous French dramatist and author; born at Paris, Feb. 15, 1807. He was educated at the College of Bourbon, and, after publishing some novels, turned his attention to writing dramas, as *Louise de Lignoralles* and *Adrienne Lecouvreur*, which latter was made famous by Rachel in 1849, and later by Bernhardt and Modjeska. He also wrote some comedies, as *Les Doigts de Fée*; *Riatrix*, dramatized from his novel of the same name; *Miss Suzanne*; *Les Deux Reines de France*; *Bataille de Dames*; *Les Contes de la Reine de Navarre*; and *Médée*; and delivered popular lectures, which were collected under the title *Les Pères et les Enfants au XIXe Siècle* (1867-69). His long list of works include *Histoire Morale des Femmes*; *L'Art de la Lecture*; *Une Élève de Seize Ans*; etc. He was decorated with the Legion of Honor in 1845; became officer in 1864, and commander in 1887.

LEGROS, ALPHONSE, a Franco-English painter; born at Dijon in 1837. He studied painting at Lyons and Paris, and exhibited a portrait of his

father at the Paris Salon when he was only 19. Champfleury, seeing this portrait, encouraged the young artist. In 1859 Legros produced *The Angelus*; in 1861 *Ex Voto*; and other works followed. Removing to England in 1863, his rustic simplicity found more favor than in Paris. He became Slade professor in University College, London, and also taught painting in the South Kensington Museum. Among his later works are *The Pilgrimage*; *The Spanish Cloister*; *The Baptism*; *The Coppersmith*; and several portraits, among them those of Carlyle, Victor Hugo and Cardinal Manning. His works became widely known through engravings and lithographs.

LEGUMIN OR VEGETABLE CASEIN, an albuminoid substance, not essentially different from the casein of milk, found in the seeds of leguminous plants. It constitutes about a fourth of the substance of peas and beans.

LEGUMINOSÆ, one of the largest families of dicotyledonous plants, but allied to the *Rosaceæ* through the Mimosas. In general, the family is characterized by its one-celled pod and irregular (papilionaceous) flowers. It is divided into three prominent tribes, the *Papilionaceæ*, containing about 5,000 species, and such well-known plants as peas, beans, clover, locust, vetches, etc.; *Cesalpiniceæ*, with about 750 species, among which are cassia, honey-locust, logwood, redbud, etc.; and *Mimosa*, with 1,350 species, among which are the acacias, mimosas and various other "sensitive plants." See also GRASSES, Vol. XI, p. 59.

LEH, a town of Kashmir, northern India, among the Himalayas, at the foot of Harding Pass, 11,530 feet in altitude, on a small plain of the Indus. It has several temples and a very large palace. It is the great rendezvous for communication between Punjab and Tibet and Chinese Turkestan, and the principal mart for shawl-wool brought from the latter country. Population, 4,000.

LEHIGH RIVER, a river of northeastern Pennsylvania, which rises in Wayne County and flows through a hilly and picturesque region, where much anthracite coal is found. After flowing in a southwesterly and then a southeasterly course, it turns northward and reaches the Delaware River at Easton. It is navigable for 70 miles from that point, and touches, in its course, Whitehaven, Mauch Chunk and Allentown, passing through a gorge or gap in the Kittatinny Mountain. Length, 120 miles.

LEHIGHTON, a post borough of Carbon County, central eastern Pennsylvania, situated on the west bank of the Lehigh River, three miles below Mauch Chunk, on the Central Railroad of New Jersey and the Lehigh Valley railroad. The Carbon County Industrial Society has its exposition grounds here. Its principal manufactures are stoves, furnaces, cars, springs, carriages, bricks and leather. Population 1890, 2,959; 1900, 4,620.

LEHIGH UNIVERSITY, an educational institution at South Bethlehem, Pennsylvania. It was founded and endowed by Asa Packer in 1866. The college provides for three courses of study: classical, Latin-scientific, and scientific and literary, besides

an engineering department. The latter includes six courses—civil, mechanical engineering, mining and metallurgy, electrical engineering, chemistry and architecture. Bethlehem is located in the center of the great engineering and mining industries of the state, so that the technical facilities of the school are exceptionally good. There are five buildings devoted to instruction, a library containing 100,000 volumes, a chapel, an observatory and a gymnasium. There are 37 instructors and about 400 students. The endowment fund and income-bearing property amount to \$2,500,000. The income from other sources amounts to \$20,000.

LEH OBSERVATORY. See TIBET, Vol. XXIII, p. 342.

LEICHHARDT, LUDWIG, a German explorer; born in Trebatsch, Prussia, Oct. 23, 1813. He was educated at the University of Göttingen, went to Australia, and carried on geological investigations in New South Wales; set out in 1844 from North Monton Bay, and with seven comrades crossed the continent, a journey of 2,500 miles. In 1847 he attempted to repeat the adventure, but no reliable information of him was afterward obtained. He wrote *Contributions to the Geology of Australia and Journal of an Overland Expedition in Australia from Monton Bay to Port Essington* (1847).

LEIDY, JOSEPH, an American naturalist; born in Philadelphia, Pennsylvania, Sept. 9, 1823. He graduated in the medical department of the University of Pennsylvania in 1844. In 1845 he became professor to the chair of anatomy of the same school, and in 1846 demonstrator of anatomy in the Franklin Medical College. In 1853 Dr. Leidy was made professor of anatomy in the University of Pennsylvania, and in 1871 he was called



JOSEPH LEIDY.

to the professorship of natural history in Swarthmore College, which position he held till 1884. On the establishment of the department of biology in the University of Pennsylvania in 1884, Dr. Leidy became its director. He held this office to the time of his death. He was a member of numerous scientific societies, and published some 800 papers on biological subjects. His principal works are *Memoir on the Extinct Species of the American Ox; A Flora and Fauna within Living Animals; Ancient Fauna of Nebraska; On the Extinct Sloth Tribe of North America; Cretaceous Reptiles of the United States; The Extinct Mammalian Fauna of Dakota and Nebraska; On the Fossil Horse; Parasites of the Termites; The Tapeworm in Birds; and Extinct Vertebrate Fauna of Western Territories*. He was also the author of *An Elementary Text-Book on Human Anatomy* (1861). The value of his scientific work was substantially recognized by the council of the Boston Society of Natural History, which awarded him the Walker prize. On account of the extraordinary merit of his researches, the prize, which usually

consists of the sum of \$500, was increased to \$1,000. Died in Philadelphia, April 30, 1891.

LEIF ERIKSON OR ERICSSON, a Norse discoverer; born in Iceland about 970. His father, Erik the Red, was discoverer and colonizer of Greenland. There are two sagas from which we derive our information of Leif Ericsson. Both tell essentially the same story, varying only in the cause ascribed for his setting out. In the *Plateya-bok* he is represented as setting out in search of land seen by Bjarne Hujulfson a few years before, while the *Hauksbok* saga says he was sent by King Olaf Trygvason to introduce Christianity into Greenland. Whatever the cause, they both agree that in the year 1000 he landed on the shores of North America—first in Newfoundland, then in Nova Scotia, and finally in New England, where he spent the winter of 1000-01, and which he called "Vinland," because of the abundance of wild grapes found there. He then set sail for Greenland, where he became chief of the colony. He is supposed to have died about 1020. The history represented in the sagas rests upon no slender foundation, being confirmed by Adam of Bremen, whose chronicle cites the discovery of Vinland as authentically reported to him by the Dane, Svend Estridson, who "knew the history of the barbarians (*sic*) by heart, as if it had been written." It may be mentioned that for several years the late Prof. E. N. Horsford pursued his researches concerning the identity of Vinland, claiming to have established the site of the chief settlement, Norumbega. See also AMERICA, Vol. 1, p. 706; and NORUMBEGA, in these Supplements.

LEIGHTON, ALEXANDER. See BIBLIOGRAPHY, Vol. III, p. 659, and LEIGHTON, Vol. XIV, p. 427.

LEIGHTON, FREDERICK, BARON, a British artist, and late president of the Royal Academy, was born at Scarborough, England, Dec. 3, 1830. Manifesting in youth a passion for painting, he had it gratified by his parents, chiefly in Rome, where he studied under the Italian painter, Filippo Meli, as well as, later on, in Berlin and Florence. In the latter city, the American sculptor, Hiram Powers, had much to do with the decision which led young



LORD LEIGHTON.

Leighton to adopt art as a profession. In 1849 he produced at Brussels his first finished picture, *Cimabue Finding Giotto Drawing in the Fields*. After this he continued his studies in Frankfort-on-the-Main, in Paris, and in Vienna and Rome, where he achieved fame by his *Cimabue's Madonna Carried in Procession through the Streets of Florence*. This fine painting was exhibited in the English Royal Academy galleries in 1855, and so striking a work of art was it that it was purchased by Queen Victoria, and afterward exhibited at the Manchester Art Treasures and in the inter-

national exhibitions. After this success, Leighton rapidly produced other attractive pictures, distinguished for their profusion of rich color and light and their admirable decorative or Renaissance effect. The more important of these are *The Triumph of Music* (1865); *Paolo and Francesca* (1861); *Star of Bethlehem* (1862); *Girl Feeding Peacocks* (1863); *Orpheus and Eurydice* (1864); *Ariadne* (1868); *Hercules Wrestling with Death* (1871); and *The Daphnephoria* (1876), a marvel of classic art, with figures of rare beauty clad in matchless draperies, and aflame with color. In 1864 he became an associate of the Royal Academy, and five years later was chosen an academician, when he contributed *St. Jerome and Electra at the Tomb of Agamemnon* as his diploma work. In 1878 he was elected president of the Academy and received the honor of knighthood. In his hands the presidency became a great and honorable function, for Leighton, in addition to his gifts as an artist and a sculptor, was an accomplished man of the world, a fine scholar and linguist, and he had the grand manner which harmonized well with his elevated position. He was created a baronet in 1886. As a sculptor he won distinction in 1877 with his *Athlete Strangling a Python*, which was acquired by the Academy, under the Chantrey bequest, for two thousand guineas. His chief later paintings include *Cymon and Iphigenia* (1884); *Greek Girls Playing at Ball* (1889); *The Bath of Psyche* (1890); *Rizpah and The Frigidarium* (1894). He died in London, Jan. 25, 1896, and was buried in St. Paul's cathedral.

LEINSTER. See IRELAND, Vol. XIII, pp. 215, 229.

LEITHA, a river of lower Austria and Hungary, rising in Wiener Wald, flowing generally near the eastern boundary of Austria, but turning into Hungary about 17° W., and entering the Danube. Its length is less than 150 miles.

LEITNER, GOTTLIEB WILHELM, a Hungarian Orientalist; born in Budapest, Hungary, Oct. 17, 1830. In 1849 the family removed to Turkey, on account of the revolution of that year. While in Turkey he became proficient in Turkish, Arabic and modern Greek, and acted as interpreter to the British commissariat in the Crimean War. He went to England, became naturalized, was appointed professor of Oriental languages and Mohammedan law in King's College, and in 1864 director of a college at Lahore, in the Punjab. In 1866-68 he was engaged in exploring Tibet and other countries north of the Himalayas, and later carried on investigations in Kashmir and Badakshan. Among his publications are a translation of Heine's *Reisebilder*; a *Philosophical Grammar of Arabic*; *Races of Turkey*; *History, Songs and Legends of Dardistan*; and *Græco-Buddhist Discoveries*. Died in Bonn, March 24, 1899.

LELAND, CHARLES GODFREY, an American author; born at Philadelphia, Aug. 15, 1824. After graduating at Princeton College in 1846, he spent two years in travel in Europe, studying at Heidelberg, Munich and Paris, and lived among the gipsies in various countries, becom-

ing familiar with their language, beliefs and customs. After his return to America in 1848 he studied law, but gave it up for literature; edited, in New York, *The Illustrated News*; established, in Boston, *The Continental Magazine* (1861); returned to Philadelphia in 1863, and for several years edited *The Press*; went to Europe in 1869 and remained eleven years; and after his return devoted himself to the introduction of manual teaching in Philadelphia public schools. He is well known by his *Hans Breitmann's Ballads* (1870). Among his other writings are *Poetry and Mystery of Dreams*; *Meister Karl's Sketch-Book*; *Sunshine in Thought*; *Legends of Birds*; *Egyptian Sketch-Book*; *English Gypsies and Their Language*; *English Gypsy Poetry*; *Algonquin Legends*; *Practical Education*; *A Manual of Wood-carving and Leather Work*.



CHARLES G. LELAND.

LELAND STANFORD JUNIOR UNIVERSITY, an institution of learning at Palo Alto, California, founded and endowed by Leland Stanford and Jane Lathrop Stanford in memory of their only son. The university was opened to students of both sexes in 1891, under the presidency of David Starr Jordan. Mr. Stanford gave to the university property worth about nine million dollars, besides the present equipments. The endowment, at present, is in large tracts of land—one of 55,000 acres in Tehama County, another of 22,000 acres in Butte County, and the Palo Alto farm, consisting of 8,000 acres. The pres-

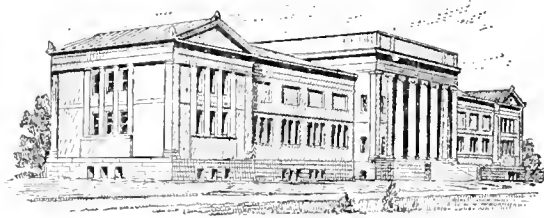

MUSEUM, LELAND STANFORD UNIVERSITY.

ent income is about two hundred thousand dollars. At the death of Mrs. Stanford the whole estate will fall to the university, bringing the endowment up to at least twenty million dollars. The control of funds and the general management are vested in a board of 24 trustees, chosen for life. The president, appointed and removable by the board, has control of the educational policy, chooses the faculty, has charge of the routine business, and is empowered to exercise an absolute veto on any legislation of the faculty. Each professor has charge of all matters relating to his department, being answerable only to the president. The general courses of the university



lead to the degree of bachelor of arts. The technical courses lead to the degrees of mechanical engineering and civil engineering. There is also a course in agriculture. A noteworthy fact is that no honorary degrees are given.

The campus is situated on the Palo Alto farm, and embraces one hundred acres. The buildings, all after the style of the old mission houses, are arranged in two quadrangles, one inclosing the other. The inner quadrangle is composed of one-story buildings joined by arcades. These are used as recitation-halls, and are fourteen in number. In the center is a court 600 feet long by 250 feet wide. The plan of the outer quadrangle embraces buildings two stories high, of the same style of architecture as the inner. The main entrance consists of a memorial arch 80 feet wide, 85 feet high, and having an open span of 46 feet. Outside the quadrangles are large dormitories and cottages, built for members of the faculty, or families who wish to live near the university while their children are being educated. The attendance has grown rapidly in numbers, and at present there is an average attendance of about a thousand, including men and women. There are 85 instructors, and the library contains over 30,000 volumes.

LEMAÎTRE, FRANÇOIS ÉLIE JULES, a French poet and critic; born at Vennecey, April 27, 1855. He finished his education in Paris, at the seminary of Notre Dame des Champs, and in the normal superior school; was professor of rhetoric at the Havre Lycée till 1880; in charge of the course in literature at the School of Letters of Besançon in 1882; in the following year professor of letters at Grenoble; and in 1884 retired to give his attention to literature. He became editor of the *Revue Bleue*; contributed to the *Temps* and to the *Journal des Débats*; received the decoration of the Legion of Honor in 1889, and in 1895 was made an academician. His best works are *Les Contemporains* (1886); *Impressions de Théâtre* (1888-90); *Sérénus, Histoire d'un Martyr* (1886); *Dix Contes* (1889); the comedies, *Revolte* (1889); *Le Député Leveau* (1891); and in the same year *Mariage Blanc*.

LE MARS, a town and the capital and a railroad junction of Plymouth County, northwestern Iowa, 25 miles N.E. of Sioux City, on the Floyd River, and on the Illinois Central and the Chicago, St. Paul, Minneapolis and Omaha railroads. It is an important grain, live-stock and lumber market, and has flour and planing mills, gas and electric lights and good educational advantages. Population 1890, 4,036; 1900, 4,146.

LEMOINE, JAMES MACPHERSON, a Canadian historian and naturalist; born in Quebec, Canada, Jan. 24, 1825; was educated at Le Petit Séminaire, and was admitted to the bar in 1850. He devoted most of his time to researches in early Canadian history, and the study of natural history and ornithology. Among his works are *L'Ornithologie du Canada* (1860); *Legendary Lore of the Town St. Lawrence* (1862); *Picturesque Quebec* (1882); *Explorations in Eastern Latitudes*

(1889); and *Conférences et Mémoires, Histoire, Archéologie* (1882-90).

LEMOINNE, JOHN ÉMILE, a French journalist; born in London, Oct. 17, 1815. He pursued his earlier studies in England, and completed his education in France. He joined the staff of the *Journal des Débats*, as English correspondent, in 1840; subsequently was appointed editor of that newspaper, and conducted it successfully through all the vicissitudes of political strife. In 1876 he was elected a member of the Academy; Senator for life in 1880; and minister to Brussels the same year, but resigned in a few months. His *Études Critiques et Biographiques* (1852) and *Nouvelles Études* (1862) contain specimens of his best style. He also wrote many articles on England and other countries. Died in Paris, Dec. 14, 1892.

LEMON, MARK, an English journalist and humorist; born in London, Nov. 30, 1809. He was educated at Cheam, near Epsom, and about 1825 wrote a farce, the first of a long series of melodramas, operettas and songs, many of the latter gaining wide though transient popularity. He also produced several novels, children's stories and essays, and appeared as a lecturer and public reader. In 1841 he helped to establish *Punch*, of which, for the first two years, he was joint editor with Henry Mayhew, and thereafter sole editor till his death; was literary editor of the *Illustrated London News* for several years; and was connected with Charles Dickens in managing *Household Words*. He died at Crawley, Sussex, May 23, 1870.

LEMON-GRASS (*Andropogon Schananthus*), a perennial grass, a native of India and Arabia, three to four feet high, possessing a strong lemon-like fragrance. An essential oil is obtained from it, which is used in perfumery, and an infusion of its leaves is used as tea. The name is also given to other fragrant species of the genus.

LEMON-OIL, an essential oil obtained by pressure or steam-distillation from lemon-peel, consists of limonene and other terpenes. Mixed with sugar and citric acid, it forms lemon-sugar, and is used in lemon flavors and medicine.

LEMONT, a post village of Cook County, northeastern Illinois, 25 miles S.W. of Chicago, on the Chicago and Alton railroad. It has quarries of fine Silurian limestone called Athens marble. Population 1900, 2,440.

LE MOYNE, a French pioneer family who rendered valuable services in Canadian exploration and colonization. Of these:—CHARLES LE MOYNE, born at Dieppe, France, in 1626, the founder of the family, emigrated to Canada in 1641; lived four years among the Hurons, and afterward at Villemarie, Canada, where he had received extensive land grants. In 1651 he repulsed the Iroquois Indians. In 1668 Louis XIV made him Sieur de Longueuil, and afterward, also, de Chateauguay. For a long time he was commander of Montreal and took part in expeditions against the Iroquois. He died in 1683. Of his eleven sons, Bienville and Iberville (q.v., in these Supplements) were the most noted. The fol-

lowing, also, distinguished themselves.—CHARLES, BARON DE LONGUEUIL, the eldest, was born at Villemarie in 1656. In his youth he served in the French army in Flanders, and afterward in Canada, where he was made major of Montreal in 1683. In 1690 he became governor of Montreal, and in 1711 he defeated the English expedition of Walker and Nicholson. He became commandant-general of the colony in 1711, governor of Three Rivers in 1720, and was governor of Montreal again from 1724 to 1726, during which time he rebuilt Fort Niagara. He was made chevalier of St. Louis. He died June 8, 1729.—JACQUES, SIEUR DE STE. HÉLÈNE, born in Montreal, April, 1659; served with his brother Pierre, in 1686, in De Troye's expedition against the English on Hudson Bay, which resulted in the capture of three forts and a war-vessel. In 1690 he shared the command of the force sent to capture Schenectady, when the French plundered and burned that town. In October of the same year he defended Quebec, which was besieged by Admiral Phips, and repulsed the English, but was wounded mortally at the moment of victory.—PAUL, SIEUR DE MARICOURT, born at Villemarie in 1663. He took part in expeditions to Hudson Bay with Iberville, and also at Quebec. Afterward he was engaged in Frontenac's expedition against the Iroquois, and negotiated peace with them in 1701, but was killed by them in April, 1704, after they had adopted him into their tribe and had begged him to be a mediator between them and the French governor.—JOSEPH, SIEUR DE SÉRIGNY, born at Villemarie, July 22, 1668. He went to France and commanded a flotilla which was to co-operate with the land-forces under his brother Iberville in taking possession of Hudson Bay. He afterward conveyed some of the first colonists to Louisiana, surveyed its coast, erected several forts there, drove the Spaniards from Dauphin Island (in Mobile Bay), and assisted in capturing Pensacola. He became captain of a ship of the line in 1720, and in 1723 was made rear-admiral and governor of Rochefort, France, where he died in 1734.—ANTOINE, SIEUR DE CHATEAUGUAY, born at Montreal, July 7, 1683. He entered the French army, and arrived at Louisiana in 1704 with a band of colonists. In 1717 he was made commandant of the troops in Louisiana, and in the next year king's lieutenant of the colony and knight of St. Louis; fought against the Spaniards, was taken captive and held till 1720. He then held command at Mobile until 1726, when he was removed from office and ordered to France. From 1727 to 1745 he was governor, successively, of Martinique, Cayenne and Cape Breton (then called Isle Royale). He died at Rochefort, France, March 21, 1747.

LEMPA, a river. See SAN SALVADOR, Vol. XXI, p. 268.

LEMPRIÈRE, JOHN, an English scholar; born about 1765. He was educated at Westminster, and at Pembroke College, Oxford; took orders in the Church of England; was, in turn, instructor in Lever's grammar school at Bolton; head master

of Abingdon and Exeter grammar schools, and rector of Meath, in Devonshire, and of Newton-Petrock. His famous *Classical Dictionary* (1792) remained for many years the standard work of reference in England on ancient mythology, biography and geography. Another work of Lemprière's was *Universal Biography* (1808). He died Feb. 1, 1824.

LEMURES. See LARES, Vol. XIV, p. 313.

LEMURIDÆ. See LEMUR, Vol. XIV, p. 447.

LENA, a post village of Stephenson County northwestern Illinois, on the Illinois Central railroad, 132 miles N.W. of Chicago. It has manufactures of carriages, sashes and blinds and shoes. It is the shipping-center of an agricultural and stock-raising region. Population 1900, 1,252.

LENA, a river of Siberia. See YAKUTSK, Vol. XXIV, p. 726; and SIBERIA, Vol. XXII, p. 5.

LENNI—LENAPE, early American Indians. See AMERICA, Vol. I, pp. 692, 693; and NEW JERSEY, Vol. XVII, p. 398.

LENORMANT, CHARLES, a French art critic and archaeologist; born in Paris, June 1, 1802; studied for the law, and afterward traveled in Italy, where he gave special attention to archaeology. In 1828 he accompanied Champollion, the younger, to Egypt, and later was a member of the commission for the exploration of Morea. After holding a number of official positions, he became professor of Egyptian archaeology at the College of France, and conservator of the Royal Library. Besides an *Introduction to Oriental History* (1838), he wrote numerous articles on art, numismatics and ceramics. He died in Athens, Nov. 24, 1859.

LENORMANT, FRANÇOIS, a French archaeologist, son of the preceding; born in Paris, Jan. 17, 1837; studied under his father, and at an early age engaged in numismatic and archaeological researches. In the interest of his science he traveled in Germany, Italy, Greece, Turkey and Egypt, and in 1874 was appointed professor of archaeology in the *Bibliothèque Nationale*. In 1878 he attended the congress of Orientalists at Florence. Besides being editor of the *Moniteur des Architectes*, and founder, with M. de Witte, of the *Gazette Archéologique*, he has contributed largely to French and other antiquarian journals, and was the author of numerous archaeological works, the most important being *Manuel d'Histoire Ancienne de l'Orient*, which has been translated into English; *Les Premières Civilisations*; *La Propagation de l'Alphabet Phénicien dans l'Ancien Monde*, the value of which to paleography can scarcely be overestimated. He died in Paris, Dec. 10, 1883.

LENÔTRE, ANDRÉ, a French landscape-gardener; born in Paris, March 12, 1613; studied painting under Simon Vouet, and displayed his genius in laying out the gardens of Versailles, Fontainebleau, Chantilly, St. Cloud and others, in France. He visited England, and laid out the parks of Kensington, St. James and Greenwich. In Rome he designed the gardens of the Vatican. Louis XIV accorded him letters of nobility in 1675. The formal and stately style of landscape-

gardening which he introduced spread over the whole of Europe and maintained itself for nearly a century. He died in Paris, Sept. 15, 1700.

LENOX, JAMES, an American philanthropist, founder of the Lenox Library; born in New York City, Aug. 19, 1800; graduated at Columbia College, and later studied law. After the death of his father, from whom he inherited vast wealth, he devoted himself to collecting rare books and manuscripts, and in 1870 he deeded his collections, valued at \$1,000,000, to trustees, for the benefit of the public, and erected for their preservation a building which cost \$450,000. Mr. Lenox's benefactions also included the land and \$500,000 for the erection of the Presbyterian Hospital in New York. He died Feb. 18, 1880.

LENSES. See LIGHT, Vol. XIV, pp. 593-595; and OPTICS, Vol. XVII, pp. 802, 803.

LENSTRÖM, CARL JULIUS, a Swedish poet and art critic; born at Gelle, May 7, 1811; educated at Upsala, and entered the priesthood in 1834. He became assistant professor of literature at Upsala in 1836, and later was appointed rector of the bishop's see of Upsala. His writings comprise articles on religious science, philosophy, æsthetics, history of literature and art, linguistics and literature. Among his best-known works are *History of Swedish Poetry* (1839-40) and *History of Swedish Literature and Art* (1841).

LENTULUS, COSSUS, surnamed GÆTULICUS, a Roman consul, 1 B.C.; was sent into Africa in A.D. 6, where he defeated the Gætuli, who had risen against their ruler, Juba, hence the surname. On the accession of Tiberius in A.D. 14, Lentulus accompanied Drusus, who was sent to quell the mutiny of the legions in Pannonia. He died at a very great age, A.D. 25.

LENZ, HEINRICH OSCAR, a German explorer; born at Leipsic, April 13, 1848, and educated at the university of his native city. After making some geological excursions into Hungary, he joined the expedition of Güssfeldt to West Africa in 1874, and spent three years in examining the region along the coast between Gaboon and the Congo. In 1879-80 he explored Morocco, Timbaktu, and Senegal, and in 1885, having been foiled in his previous attempts to determine the watershed between the Nile and Congo basins, he led an expedition across Africa by way of Lakes Tanganyika and Nyassa, returning to Vienna in 1887. After his return he became professor of geography at the University of Prague. He has written *Skizzen aus Westafrika* (1878); *Timbaktu* (1884).

LENZ, JACOB MICHAEL REINHOLD, a German dramatist. See GERMANY, Vol. X, p. 540.

LEO XIII, POPE, the 258th Roman pontiff and 257th successor of St. Peter; son of Count Ludovico Pecci, by his wife, Anna Prossperi. He was born at Carpineto, in the diocese of Anagni, in the States of the Church, March 2, 1810, and was baptized by the names of Vincenzo and Gioacchino. In 1818 his father sent him, along with his elder brother, Giuseppe, to the Jesuit College of Viterbo. In November, 1824, he en-

tered the schools of the Collegio Romano, then restored to the Jesuits. Young Pecci signalized himself by his assiduity and talent, and in 1828 won the first premium in physico-chemistry, and the first *accessit* in mathematics. While studying philosophy, Pecci was intrusted, despite his youth, to give repetitions in philosophy to the pupils of the German College. In his third year of philosophy he sustained a public disputation and obtained the first premium (1830). The following



POPE LEO XIII.

year, being then but 21 years old, he obtained the *laurea* in philosophy. Even in Viterbo young Pecci was noticed for his ability and for his perfect propriety of conduct. In Rome he seemed entirely devoted to study, and took no part in entertainments, conversazioni, amusements or plays. At the age of 12 or 13 he wrote Latin, prose or verse, with facility, and it may be mentioned that after he became pope a volume of his verses, chiefly Latin, was printed at Udine. Having entered the College of Noble Ecclesiastics, the Abbate Pecci frequented the schools of the Roman University to learn canon and civil law. Cardinal Antonio Sala took much interest in the young student and assisted him with advice and instruction. Becoming a doctor in laws, he was made, by Pope Gregory XVI, a domestic prelate and referendary of the Segnatura, March 16, 1837. Cardinal Carlo Odescalchi gave Pecci holy orders, and on Dec. 23, 1837, conferred the priesthood upon him. Gregory XVI bestowed upon him the title of prothonotary apostolic, and appointed him apostolic delegate at Benevento, Perugia and Spoleto in succession. In these important posts he ruled with firmness and prudence, and while at Benevento by his energy he put a stop to the brigandage which had before infested that district. In 1843 he was again promoted by Pope Gregory XVI, being sent as nuncio to Belgium, and on January 17th, in that year, he was created archbishop of Damietta, *in partibus infidelium*, to qualify him for his office of nuncio. He remained at Brussels for three years and was nominated bishop of Perugia on Jan. 19, 1846, about four months previous to the death of Gregory XVI. He was created and proclaimed a cardinal by Pius IX, in the consistory of Dec. 19, 1853. In September, 1877, he was selected by Pope Pius IX to fill the important office of cardinal camerlengo of the Roman Catholic Church, which post had become vacant by the death of Cardinal de Angelis. In that capacity, after the death of the late pope (Feb. 7, 1878), he acted as head of the church in temporal matters, made the arrangements for the last solemn obsequies of the pontiff, received the Catholic ambassadors and superin-

tended the preparations for the conclave. Sixty-two cardinals attended the conclave, which was closed in the Vatican on Feb. 18, 1878. In the second scrutiny, on the evening of Tuesday, Cardinal Pecci's votes rose to 34 and in the scrutiny on Wednesday (February 20th) morning to 44. The election was then at an end, and the cardinal camerlengo was made pope by acclamation. The news was officially proclaimed to the outside world from the gallery of St. Peter's, when it was announced that his Holiness had assumed the name of Leo XIII. On March 3d he was crowned in the Sistine Chapel, all the ancient ceremonies being observed, save the benediction, *Urbi et Orbi*, from the loggia of St. Peter's. The history of the pope since his election is the history of the papacy, and as such it would occupy too much space to tell it here at the length that it might be thought to deserve. Suffice it to say, that Leo XIII adopted a course of perfect consistency as a pontiff willing to act with modern governments, but determined to abate no jot of his rights as head of the church and as the despoiled sovereign of Rome. After his accession he refused to accept the income regularly voted him by the Italian Parliament, confining his movements to the Vatican palace and grounds, secured to him by the government, and issued numerous encyclicals, demanding a restoration of the temporal power and sovereignty, yet moderate and dexterous in his relation with foreign powers. His chief minister was Cardinal Jacobini, a man of the world. With the help of his chief he was able to bring to a fairly successful issue the "Kulturkampf" in Prussia and to make tolerable terms for the clergy in France. His encyclical on "Labor" (1891) excited a profound interest. He celebrated his golden jubilee as bishop in 1893. The Pope summoned a conference of the patriarchs of the Eastern Church at the Vatican in October, 1894, but no practical results followed, and the same may be said of his letter to the English people in April, 1895, urging them to return to holy unity with the Church of Rome. In 1896, replying to an open letter of Gladstone's, he confirmed the decrees of his predecessors by a declaration that "all ordinations made under the Anglican rite are absolutely invalid." In 1898 he composed a Latin oratorio, *Battesimo di Clodoveo*.

LEO, HEINRICH, a German historian; born at Rudolstadt, March 19, 1799. He became professor of history at the University of Halle, and produced a large number of works of historical value; among them, a *Manual of the History of the Middle Ages* (1830); *History of the Italian States* (1829); and a number of articles in the *Evangelische Kirchenzeitung*. He died April 24, 1878.

LEO DIACONUS. See BYZANTINE HISTORIANS, Vol. IV, p. 613.

LEOMINSTER, a town and railroad junction of Worcester County, central Massachusetts, four miles S. of Fitchburg, on the Nashua River, and on the New York, New Haven and Hartford railroad. It has manufactories of furniture, horn

goods, forks, linen, woollens, shirts, buttons, toys, leather-board, paper boxes, shoes, paper, baby-carriages, and piano-cases; has city water, electric and gas lights, electric street and suburban railways, and a public library of nearly 15,000 volumes. Pop. 1890, 7,269; 1900, 12,392.

LEON, a town, the capital of Decatur Co., Iowa, 60 miles S. of Des Moines, on the Chicago, Burlington and Quincy and the Keokuk and Western railroads, in an excellent grazing country; makes large shipments of cattle, hogs, horses, and sheep. Pop. 1900, 1,905.

LEON, ISLA DE. See CADIZ, Vol. IV, 626-28.

LEONARDO OF PISA. See PISONUS, Vol. XIX, p. 124.

LEONCAVALLO, RUGGIERO, Italian opera composer; born in Naples, March 8, 1858. Has produced *I Pagliacci* (1892); *I Medici* (composed in 1877, but not performed till 1893); *La Vie de Bohême* (founded on Murger's novel, 1897); and *Roland of Berlin* (1899).

LEONE, PILATO. See BOCCACCIO, Vol. III, 844.

LEOPOLD II (LEOPOLD-LOUIS-PHILIPPE-MARIE VICTOR), King of the Belgians, son of King Leopold I; born at Brussels, April 9, 1835, and married, Aug. 22, 1853, the Archduchess Maria of Austria. As Duke of Brabant, he took a prominent part in several important discussions in the Senate, especially in that relating to the establishment of a maritime service between Antwerp and the Levant. On the death of his father, Dec.



LEOPOLD II, KING OF BELGIUM.

10, 1865, he succeeded to the throne as Leopold II. He was prominent in carrying out the work of exploring Africa, and was practically the founder of the Congo Free State, which, by the international conference of 1885, was placed under his individual sovereignty. By will dated Aug. 2, 1889, he bequeathed his sovereign rights to Belgium.

LEOPOLD II, Grand Duke of Tuscany. See FLORENCE, Vol. IX, p. 336.

LEOPOLDVILLE, the most important establishment in the Congo Free State, situated on the left bank of the Congo, at the outlet of Stanley Pool, and the capital of Stanley Pool district, founded in Feb., 1882, by Henry M. Stanley. Its importance is due to the fact that it is at the head of the 235 miles of cataracts in the Congo, and consequently at the lower end of upper Congo navigation, of which there are some 8,000 miles, including tributaries. Several steamboats have been transported overland in sections, and here put together for upper Congo service. A railroad from Matadi, at the foot of the rapids, to Leopoldville, 247 miles, was completed in July, 1898.

LEPIDODENDRON, a genus of fossil plants, belonging to the club-mosses, one of the groups of pteridophytes, found especially in the lower and middle Carboniferous deposits. They were

large, branching trees, with pine-like cones, and covered with spirally disposed leaves, replaced by peculiar rhombic scars, giving the name to the genus.

LEPIDOPTERA. See INSECTS, Vol. XIII, pp. 150, 151; and BUTTERFLIES AND MOTHS, Vol. IV, pp. 592-597.

LEPIDOSTEIDÆ, a family of fishes. See ICHTHYOLOGY, Vol. XII, p. 687.

LEPORIDÆ. See MAMMALIA, Vol. XV, p. 421.

LEPSIUS, KARL RICHARD, a German Egyptologist; born at Naumburg, Dec. 23, 1813. After studying at the universities of Leipsic, Göttingen and Berlin, he gained his doctor's diploma in 1833, with an essay on the Eugubine Tables. In 1834, at Paris, he gained the Volney prize by his essay on *Palæographie als Mittel der Sprachforschung*. After devoting considerable time to Egyptian studies at Rome, he made historical researches from 1842 to 1845 in Lower and Upper Egypt, and brought a valuable archæological collection home to Berlin, where he was professor for some years. In 1866 he explored the delta of the Nile. In 1874 he was made chief of the Prussian State Library at Berlin. He wrote, in German and English, a *Universal Standard Alphabet* (1855-63); *Chronologie der Ägypter* (1849); and *Die Denkmäler aus Ägypten und Ethiopien* (1849-59); and many other works. He died in London, July 10, 1884.

LEPTOCARDII. See ICHTHYOLOGY, Vol. XII, pp. 685, 695.

LEPTOSPERMUM, a genus of trees and shrubs, natives of Australia and New Zealand, of the family *Myrtaceæ*. They are evergreen, with leaves somewhat resembling those of myrtles. Some of them bear the name of tea-tree, because the leaves have been used as a substitute for tea. *L. scoparium* is sometimes called the New Zealand tea-plant.

LEPTOSTRACA, a subclass of marine crustaceans, composed of forms with a characters connecting the entomostracans and malacostracans. These animals were considered phyllopods by some authors. There are few species, the majority belonging to the genus *Nebalia*. Some species are found as Cambrian and Silurian fossils.

LERDO DE TEJADA Y CORREAL, SEBASTIAN, a Mexican statesman and diplomat; born in Jalapa, Mexico, April 25, 1825. In 1855 he became a judge of the supreme court of Mexico, and in 1857 was made foreign minister under President Comonfort. He was a Liberal in politics, and after the rise of the Church party, joined Juarez, with whom he acted until 1867, being one of the most active leaders in the movements which led to the overthrow of Maximilian. In December of the latter year he became chief justice of the supreme court, and on July 18, 1872, by virtue of his office, succeeded to the Presidency on the death of Juarez, being elected in December of the same year. He began his term under very favorable auspices, but gradually lost support, owing to his infringements of the rights of the states, and his evident desire to

centralize the government. He claimed to have been re-elected in 1876, but being overthrown by the revolutionary forces under Diaz, he fled to the United States, and eventually took up his residence in New York City, where he died, April 21, 1889.

LÉRINS, ILES DE, a few small French islands in the Mediterranean, off the coast of Alpes Maritimes, in long. 7° W., consisting of the fortified islands, Ste. Marguérite and St. Honorat, on the first of which was imprisoned the Man in the Iron Mask from 1686 to 1689. On the second was founded, in the fourth century, the convent of the Lérins, which became a famous school of theology, and passed into the Benedictine Order. After the middle of the seventeenth century it lost importance, and is now in ruins. Between the two islands is the anchorage of Frioul, accommodating vessels of sixteen feet draft.

LERMA, FRANCISCO DE ROXAS DE SANDOVAL, a Spanish statesman; born about 1550. Upon the accession of Philip III in 1598, he was given the title of duke, and made Prime Minister of Spain, in which capacity he was practically ruler for twenty years. In 1609 he issued the decree of proscription against the Moors, by which several thousand families, forming one of the richest and most industrious elements in the Spanish population, were driven out of the country. He lost the royal favor in 1618. He died in 1625.

LERNÆOIDEA, a group of copepod crustaceans parasitic in the skin and gills of fishes. The worm-like females are greatly degenerated, and scarcely have any resemblance to a crustacean. The young females have the normal crustacean characters before assuming the parasitic life. The males are free-swimming, and have the normal crustacean form. The *Lernææ* are often known as fish-lice.

LEROLLE, HENRI, a French painter; born at Paris in 1848; was a pupil of the School of Fine Arts and attended the studio of Lamothe. He received a first-class medal in 1880 and the decoration of the Legion of Honor in 1889. He was a member in the latter year, of the jury of admission at the Universal Exposition. Among his works, which are noted for their interpretation of nature in evening effects, are *In the Country* (1880); *At the Organ* (1885); *The Flight into Egypt* (1891).

LEROS, a Turkish island in the Ægean Sea, south of Samos, at lat. 37° 10' N., long. 26° 50' E. It is six miles long and four wide, is very fertile, and has good harbors. It was colonized from Miletus and ruled by her down to Roman times. The ruins of the town of Leros are here. White marble is quarried. Population, about 4,000.

LE ROY, a village of Genesee County, western New York, 23 miles S.W. of Rochester, on Oatka Creek, and on the New York Central and Hudson River and the New York, Lake Erie and Western railroads. It is in a salt and limestone region, has salt-works, lime-kilns, stone-quarries, and flour, gypsum, plaster, saw and planing mills. It

has good water-power, is the seat of Ingham University for women, has a union school, public library and an art museum. Population 1890, 2,743; 1900, 3,144.

**LEROY-BEAULIEU, PIERRE PAUL**, a French economist; born at Saumur, Dec. 9, 1843; studied at the Lycée Bonaparte, spent some time in Rome, and in 1864 and 1865 attended the Universities of Bonn and Berlin. On his return to Paris he gave himself up to a study of political economy, and contributed to various journals and reviews. His first memoir, *De l'Influence de l'État Moral et Intellectuel des Populations Ouvrières sur le Taux des Salaires*, was crowned in 1867 by the Academy of Moral Science. He was appointed professor of finance in the Free School of Political Science in 1872, and shortly after founded *L'Économiste Français*. He was elected a member of the Academy of Political and Moral Science in 1878, and in 1880 succeeded his father in law, Michel Chevalier, as professor of political economy in the Collège de France. The decoration of the Legion of Honor was bestowed upon him. Among his works, besides the one already mentioned, are *Essai sur la Répartition des Richesses* (1882); *Précis d'Économie Politique* (1888); *L'État Moderne et ses Fonctions* (1890).

**LESBIC ÆOLIC**, dialect. See GREECE, Vol. XI, p. 132.

**LES CAYES OR AUX CAYES**. See HAITI, Vol. XI, p. 544.

**LES ECHELLES**, a village in Isère, southwestern France, 14 miles S.S.W. of Chambéry. The valley beyond this village, on the road to Chambéry, is blocked up by a huge limestone rock 800 feet high, over which travelers formerly used to climb by means of ladders, hence the name of the village. Through this mass of limestone a tunnel now extends, 25 feet high, 25 feet wide and 1,000 feet long. The work was projected and commenced by Napoleon I, and finished in 1817 by the King of Sardinia.

**LES ILES MALOUINES**. See FALKLAND ISLANDS, Vol. IX, pp. 14-16; and in these Supplements.

**LESLEY, JOHN PETER**, an American geologist; born at Philadelphia in 1819. He graduated at the University of Pennsylvania in 1838, and during the three following years served as assistant on the geological survey of Pennsylvania. From 1841 to 1845 he studied theology at Princeton, New Jersey, and at the University of Halle, Germany. Then he became missionary to the Germans in Pennsylvania till 1847, and preached for three years in the Congregational Church at Milton, Massachusetts. But here his theological views underwent a change, in consequence of which he left the pulpit and settled in Philadelphia, where he engaged as a professional expert in geology. In 1872 he was appointed professor of geology and mining, and also dean of the scientific faculty in the University of Pennsylvania. His geological work included numerous special examinations of coal-oil and iron fields in the United States and Canada. In 1874 he was made chief geologist of Pennsylvania, with charge of a complete resurvey of the state. He was elected presi-

dent of the American Association for the Advancement of Science in 1884. Besides some seventy volumes of geological reports, he published a *Manual of Coal and Its Topography: The Iron Manufacturers' Guide*; and *Man's Origin and Destiny, as Seen from the Platform of the Sciences* (1868; revised 1887). Mr. Lesley was credited with the authorship of *Paul Dreifuss* (1882). The article PENNSYLVANIA, in this ENCYCLOPÆDIA, was contributed largely by him.

**LESLIE, HENRY DAVID**, an English composer; born at London, June 18, 1822; received his musical education there, under Charles Lucas. In 1855 he formed the celebrated Henry Leslie Choir, of which he was conductor until the choir was disbanded in 1887. He was appointed conductor of the Herefordshire Philharmonic Society in 1863, and in 1874 became director of the Guild of Amateur Musicians. His compositions include a *Te Deum and Jubilate in B* (1846); *Immanuel* (1854); *Bold Dick Turpin*, an operetta (1851); *Daughter of the Isles*, a cantata (1861); and *Ida*, an opera (1864). He died Feb. 4, 1896.

**LESQUEREUX, CHARLES LEO**, a Swiss botanist; born at Fleurier, Neuchâtel, Nov. 18, 1806; educated at Neuchâtel, Weimar and Berlin. He was principal of an academy at Chaux-de-Fonds, Switzerland, but was forced to resign on account of deafness. He emigrated to America through the influence of Professor Agassiz and assisted the latter in his work at Cambridge. He then went to Columbus, Ohio, where, with William T. Sullivant, he made a study of American bryology, their published collections of "Musci Exsiccati," being remarkably fine. He afterward made a special study of the fossil flora of the coal-measures in the United States, and in 1864 was elected a member of the National Academy of Sciences. Among his publications are *Catalogue of the Mosses of Switzerland and Mennirs* (1840); *Musci Boreales Americanis Exsiccati*, with Sullivant (1856); *Manual of the Mosses of North America*, with Thomas P. James (1884). He died at Columbus, Ohio, Oct. 25, 1889.

**LESSEPS, FERDINAND, VISCOUNT DE**, a French diplomatist and engineer; born at Versailles, Nov. 19, 1805. At the age of 24

he entered the French diplomatic service as *attaché* at Lisbon, and subsequently held consular appointments at Barcelona, Tunis and Alexandria. In 1841, while detained in quarantine at Port Said, his great project of cutting a canal through the Isthmus of Suez dawned upon him. He visited Egypt in 1854, and in 1856 published a report upon the proposed canal. The project was approved by the viceroy Said Pasha, but owing to the distrust of the Porte and the hostility of England, its execution for a time was suspended. In 1882, by his firmness and vigorous action in securing the



VISCOUNT DE LESSEPS.

neutrality of the canal, he aroused much hostility. He also promoted the construction of the Corinth canal. In 1873 he began to concentrate his energy on the Panama canal, a project which in 1874 was agitated vigorously by the French press. In 1876 he formed a company for making preliminary surveys, and in 1879 he obtained from the Colombian government the exclusive privilege of constructing a canal between the two oceans, through Colombian territory. When he opened subscription lists, all the capital was subscribed which he then thought necessary. The Inter-Oceanic Canal Company was definitely constituted Jan. 31, 1881, and the work was commenced in October. Lesseps, believing himself better informed than others, decided that the canal should be at sea-level. The estimated cost of such a canal had been \$300,000,000, but he reduced this to \$120,000,000. When the company dissolved in 1889 a total of \$280,000,000 had been expended, and but a small portion of the work completed. After certain charges of fraud and bribery had been brought against the company, the French government prosecuted Lesseps and the other officers of the company. A sentence of imprisonment was passed, but in the case of Lesseps himself it never was carried into effect. He was decorated with the grand cross of the Legion of Honor in 1869, made a member of the Academy of Sciences in 1875, and a member of the French Academy in 1884. In 1870 Queen Victoria made him Knight Grand Commander of the Star of India. In 1886 the French government sent him as delegate at the dedication of the *Statue of Liberty* in New York harbor. Died near Paris Dec. 7, 1894.

LESSER, A. MONAF, German-American physician; born in Brandenburg, Prussia, June 22, 1855; attended the high school and university. In the Franco-Prussian war (1870-71) he was the youngest Red Cross assistant in the field. He began his medical studies in 1876 at Berlin, continued them at Munich and Montreal, and in 1882 graduated at the New York University. In 1898 he was appointed surgeon-in-chief of the American National Red Cross, and served as such during the Cuban campaign in the Spanish-American war, his services receiving favorable mention in the official report of the surgeon-general of the United States army, and also high praise in the United States Senate. He is now (1899) surgeon-general of the Red Cross hospital in New York, and ranks as the leading yellow-fever specialist in the world. In his practice he never uses either quinine or alcohol. His wife is the well-known "Sister Bettina."

LESUEUR, a borough of Lesueur Co., Minn., on the Minnesota river, 60 miles S. W. of St. Paul, in a corn, wheat, cattle, pork, and sheep region; has a graded school, and factories of flour, woolen goods, and wagons. Population 1890, 1,763; 1900, 1,937.

LESUEUR, EUSTACHE, a French painter; born in Paris, Nov. 19, 1617. With Lebrun he studied in the school of Simon Vouet. In 1648, when the Academy of Painters was founded, Lesueur was one of the twelve original members. His works, which, from their ease and grace of style, have given the artist the name of the "French Raphael," are to be found in the principal churches of Paris. The Louvre possesses 36 religious and 13 mythological

pictures by him, the former including his great series of 22 paintings illustrating the life of St. Bruno, and his *St. Paul at Ephesus*. Died April 30, 1655.

LETTER OF CREDIT, a letter from a person in one place, directed to a person in another place or country, requesting him to furnish the party named therein, or the bearer, such credit as he may desire, which may or may not be limited in amount. The writer of the letter undertakes to stand responsible for the goods, money, or other credit which may be furnished in accordance with the terms of the letter. Letters of credit may be either general, as when directed to anyone who may see fit to honor the request, or special, when directed to some particular person. They may be procured by depositing money, collateral, or other valuable thing with the person issuing the letter, the debt created by honoring the letter being between the writer and him who honors the letter, and not between the latter and him to whom the money is paid. This class of letters of credit is in frequent use with persons who wish to travel abroad, and do not desire to carry the money necessary to defray their expenses. Letters of credit may also be issued merely as an accommodation, and without valuable consideration, in which case the act of honoring the letter creates a debt on the part of both the writer of the letter and him who receives the money or credit. The bearer of a letter of credit may use it or not, as he chooses, and he will be liable only upon his receiving money or credit thereon.

LETTERS OF MARQUE AND REPRISAL. See PRIVATEER, Vol. XIX, p. 764.

LETTIS AND LETTISH LANGUAGE AND LITERATURE. See EUROPE, Vol. VIII, p. 702; LITHUANIANS, Vol. XIV, pp. 701-03.

LETTUCE. See HORTICULTURE, Vol. XII, 284.

LEUCADIA, one of the Ionian Islands. See SANTA MAURA, Vol. XXI, p. 297.

LEUCÆMIA. See PATHOLOGY, Vol. XVIII, 376.

LEUCÆTHIOPE, peoples of Hamitic stock who preceded the Berbers of North Africa.

LEUCANILINE, a colorless organic base obtained by oxidation of rosaniline, one of the coal-tar dyes.

LEUCIN OR AMIDOCAPROIC ACID, a white crystalline substance ( $C_6H_{11}O_2NH_2$ ), one of the chief products of the decomposition of nitrogenous matter; may be obtained by treating horn shavings or muscular fiber with sulphuric acid.

LEUCKART, KARL GEORGE FRIEDRICH RUDOLF, a German zoölogist; born at Helmstädt, Oct. 7, 1823, studied at Göttingen; in 1850 became professor of zoölogy at Giessen, and in 1869 at Leipsic. He especially distinguished himself by his study of the entozoa, and by his system of zoölogical classification. His great work is *The Parasites of Man* (English translation by Hoyle, 1886). His fame, however, rests mainly upon his ability as a teacher, more naturalists of celebrity having received their education from him than from any other instructor in Europe.

LEUCOCHALCITE, a nearly white hydrous copper arsenite, occurring with malachite and calcite.

LEUCOCYTES. See ANATOMY, Vol. I, p. 846.

LEUCOMA, a white opacity of the cornea, caused by inflammation, leading to the formation of cicatricial tissue on the ulcerated surface or between the layers

of the cornea. It is re-absorbed on the cessation of the inflammation sometimes, and the cornea recovers its transparency; but in many cases it is persistent and incurable.

LECTRA, BATTLE OF, where the ascendancy of Sparta received a fatal check. See GREECE, Vol. XI, p. 103.

LEUTZE, EMMANUEL, an American painter, born at Gmünd, Würtemberg, May 24, 1816. His parents brought him to Philadelphia in his infancy. He first attempted drawing while attending his father's sick-bed, and soon became skillful. In 1840 he painted an *Indian Gazing at the Setting Sun*, and with such success that he received many orders for similar work, and in 1841 was enabled to visit Düsseldorf, where he studied under K. F. Lessing. There, and later in America, he produced historical paintings connected with American history; notably, *Columbus Before the Council of Salamanca: Columbus in Chains; Columbus Before the Queen; Washington Crossing the Delaware; Washington at Monmouth; Storming of Teocalli; Settlement of Maryland by Lord Baltimore*. One of his last pictures is entitled *Westward Ho*, painted for the staircase of the Capitol at Washington. He was made a member of the National Academy in 1860. His death occurred at Washington, District of Columbia, July 18, 1868.

LE VAILLANT, FRANÇOIS, a French traveler and ornithologist; born at Paramaribo, Dutch Guiana, in 1753. After studying natural history in France, he set out in 1781 for South Africa, where he traveled for 16 months, and on a second trip to the same regions in 1784 he traveled for eighteen months, making valuable collections. He died at Sézanne, France, Nov. 22, 1824. For his writings on ornithology, see ORNITHOLOGY, Vol. XVIII, pp. 8-11.

LEVANT, THE, a geographical name given to the eastern waters and shores of the Mediterranean, especially the coasts of Asia Minor, Syria and Egypt. The name Levant originated early in the middle ages, when the Italian republics controlled European commerce.

LEVEE, in the United States, an embankment to prevent inundation, especially on the Mississippi River. See MISSISSIPPI, Vol. XVI, p. 521.

LEVELERS, the name of a political party of Great Britain. See ACEPHALI, Vol. I, p. 92.

LEVELS AND LEVELING. See SURVEYING, Vol. XXII, pp. 707, 717-720.

LÉVÊQUE, JEAN CHARLES, a French educator; born at Bordeaux, Aug. 7, 1818. He was educated at the college and normal school of his native city; was professor of philosophy in the colleges at Angoulême and Besançon, afterward at the French School at Athens, and subsequently at Toulouse and Nancy. In 1861 he succeeded Barthélemy Saint-Hilaire in the chair of Greek and Latin philosophy at the College of France. He was chosen a member of the Academy of Moral and Political Sciences in 1865, and in 1873 was elected vice-president. His numerous philosophical works, for which he received several prizes, include *La Science du Beau* (1860) and *Harmonies Providentielles* (1872).

LEVI. See LEVITES, Vol. XIV, pp. 487-489.

LEVI, LEONE, an English statistician; born at Ancona, Italy, of Jewish parents, July 6, 1821. He settled in Liverpool in 1844; was naturalized in 1847 and early joined the Presbyterian Church; was one of the founders of the Liverpool Chamber of Commerce. In 1852 he became professor of the principles and practice of commerce in King's College, London. He did much for the reform of commercial law and practice and the utilization of statistics. Among his works are *Commercial Law of the World; History of British Commerce; War and Its Consequences*; and *International Law*. He died in London, May 9, 1888.

LEVULOSE. See SUGAR, Vol. XXII, p. 624.

LEVY, MAURICE, a French civil engineer; born at Ribeauville, Feb. 28, 1838; studied at the Polytechnic School and the École des Ponts et Chaussées; graduated in 1861, and became engineer-in-chief in 1880. Attached at first to the service of the city engineers of Paris, he became director of the navigation of the Marne and member of the commission on general levels of France. He also engaged in teaching, becoming professor of applied mechanics at the École Centrale and the Collège de France; and in 1885 succeeded Serret in the chair of Mécanique Céleste. In 1879 he became an officer of the Legion of Honor, and a member of the Academy of Sciences in 1883. Aside from articles on hydrodynamics, heat, etc., his chief work is *La Statique Graphique et ses Applications aux Constructions*.

LEWALD, FANNY, a German novelist; born at Königsberg, March 24, 1811, of Jewish parents, but became in childhood a convert to Christianity. She began to write when about thirty, and from 1840 lived in Berlin; in 1855 she married Adolf Theodor Wilhelm Stahr, the literary critic. At different times she visited many parts of Europe with her father and her husband. Her books on Italy (1847) and Great Britain (1852) were the most valuable outcome of these journeys. Her best work is perhaps *Von Geschlecht zu Geschlecht* (1863-65). She also wrote *Diogena* (1847); *Wandlungen* (1853); *Die Kammerjungfer* (1856); *Benedikt* (1874); and *Stella* (1883). Died in Dresden, Aug. 5, 1889.

LEWES, the main headstream of the Yukon; rises in Hootalinqua (or Hotilinku) spring, in 59° 10' N. lat., and 132° 40' W. long., in British Columbia; flows N.W. into Yukon district, Canada, and, joining the Pelly near Fort Selkirk, forms the Yukon; length about 400 miles. At the confluence its discharge is 37,700 cubic feet per second; that of the Pelly is 29,300 cubic feet.

LEWES, a town of Sussex Co., Del., on Delaware Bay, opposite the Delaware breakwater, which forms a good harbor, 35 miles S. S. E. of Dover; is a station of the Old Dominion steamship line; has a large trade in fruit and early vegetables; fishing, farming, and wrecking are the chief pursuits. Pop. 1900, 2,259.

LEWIN, THOMAS, an English author; born at Ifield, Sussex, April 19, 1805; educated at the Merchant Taylors' School, and at Worcester and Trinity colleges, Oxford; called to the bar in 1833, practiced in Chancery, and in 1853 was appointed one of the conveyancing counsel to the court. Wrote *The Law of Trusts and Trustees* (1842),



which has become an authority on this subject. *The Life and Epistles of St. Paul* is Lewin's great work, for the final preparation of which he spent over twenty years in the study of the apostle's missionary journeys, visiting nearly every place named in the New Testament in connection with Paul. Some of his other writings are *Cesar's Invasion of Great Britain* (1862); *Siege of Jerusalem by Titus* (1813); *Fasti Sacri; or, A Key to the Chronology of the New Testament* (1865). Mr. Lewin's views regarding the sacred localities in Jerusalem differed essentially from those of Robinson and others, and have occasioned considerable controversy.

LEWIS, ANDREW, an American general; born in Donegal, Ireland, about 1730; when very young, was brought to America by his parents, who settled at Bellefonte, Virginia. He was a volunteer in the Ohio campaign in 1754; commanded the Sandy Creek expedition in 1756; was captured by the French at Fort Duquesne in 1758; appointed Virginia commissioner to make treaty with the Iroquois at Fort Stanwix in 1768; was made brigadier-general in 1774, and defeated the Shawnee Confederacy at the mouth of the Great Kanawha River. He took part in the convention of 1775, and, at the request of Washington, in 1776 was appointed brigadier-general by Congress, and put in command of the expedition to dislodge Lord Dunmore from Gwynn's Island. Owing to ill health, he retired from the army in 1777, and died in Bedford County, Virginia, Sept. 26, 1780. General Lewis's statue is one of the cluster around the Washington monument in Richmond.

LEWIS, CARROLL. See DODGE, CHARLES L., in these Supplements.

LEWIS, DIO, an American physician; born at Auburn, New York, March 3, 1823; studied at Harvard Medical School, and practiced for a time at Port Byron, New York, and at Buffalo. He founded an institution for training teachers at Boston in 1863, and in 1864, at Lexington, Massachusetts, he established a school for young ladies. He published numerous works on health and hygiene, and wrote a great deal on education and gymnastics as an element in educational training. His death occurred May 21, 1886, at Yonkers, New York.

LEWIS, EDMONIA, an American sculptor; born near Albany, New York, July 4, 1845, of mixed white, African and Indian blood, and educated at Oberlin, Ohio. She early began to model in clay. Her first work was a bust of Colonel Robert G. Shaw, who commanded the first negro regiment from a free state enlisted in the national service. In 1865 she went to Rome, where she studied her art, and where she remained. Her works show considerable talent. Among them are *The Freed-Woman*; *Death of Cleopatra*; *The Old Arrow-Maker and his Daughter*; *Hagar*; *Rebecca at the Well*; and *The Marriage of Hiawatha*.

LEWIS, JAMES, an American actor, born in Troy, New York, in 1838; taught school in his young days, and made his first appearance on the stage at the Troy Museum when about 20 years of age. Afterward he appeared in Albany, and then went South and West, appearing during

the tour in Cleveland, Ohio, in the famous company of John Ellsler. The troubles incident to the Civil War forced him to give up a part of his Southern trip, and he returned North, and joined the company of the Continental Theater in Boston, where he was very successful as Dick Swiveller in a dramatization of *The Old Curiosity Shop*. He joined the company of Augustin Daly in 1869, and for over a quarter of a century was identified with the superb productions of that manager, his Touchstone being considered by many as his best personation, though the low comedy rôle of the modern plays produced by Daly always was raised to the plane of the artistic by Mr. Lewis's rare gifts as a comedian. He died at West Hampton, Long Island, Sept. 10, 1896.



JAMES LEWIS.

LEWIS, MORGAN, an American general and statesman; born in New York, Oct. 16, 1754, son of Francis Lewis, one of the signers of the Declaration of Independence; graduated at Princeton in 1773, and studied law in the office of John Jay. He joined the Continental army in 1774. In 1786 he was aid to General Gates, with the rank of colonel; fought at Saratoga in 1777, and in 1778 at the battle of Crown Point. After the war he was made attorney-general of New York in 1791, and a judge of the supreme court in 1792. In 1804 he was elected governor of New York, but in 1807 he returned to the practice of law. In 1812 President Madison made him quartermaster-general of the United States army, and in the next year he was promoted to the rank of major-general. He served at Niagara, and afterward took charge of the defense of New York. At the close of the war he advanced the funds necessary for the discharge of the American prisoners in Canada. He afterward devoted himself to agriculture, serving also as president of the New York Historical Society, and grand master of the order of Free Masons. He died in New York City, April 7, 1844.

LEWIS, WILLIAM BEVAN, a British physician and author; born at Cardigan, South Wales, May 21, 1847; educated at Guy's Hospital, London, and received his license from the Royal College of Physicians and Surgeons of that city. In 1871 he became connected with the West Riding Asylum, and later lecturer on mental diseases at the Yorkshire College and Leeds School of Medicine, and examiner in mental diseases at Victoria University. He wrote a large number of works, principally on brain and nervous diseases.

LEWIS, WILLIAM JAMES, an English scientist; born near Newtown, Montgomeryshire, Wales, Jan. 16, 1847; educated at Oxford. He was a member of the English total-eclipse expeditions of 1870 and 1871. He published his observations in *Solar Eclipses*, issued by the Royal Astronomical Society

He contributed several papers on crystallography to the *Philosophical Magazine*. He held an appointment in the mineral department of the British Museum from 1875 to 1877. In 1881 he became professor of mineralogy at Cambridge.

LEWISBURG, a borough and the capital of Union County, eastern central Pennsylvania, on the west branch of the Susquehanna River, 80 miles above Harrisburg, and on the Pennsylvania and the Philadelphia and Reading railroads. It is the seat of Bucknell University, a Baptist co-educational school, with 29 instructors, 432 students and a library of 13,250 volumes, and a college, an academy, a girls' seminary, music and art schools, an observatory with a Clark equatorial telescope, and other buildings. Lewisburg is supplied with city water, gas and electric lights and a fire department. It manufactures hosiery, nails, furniture, bed-springs, flour and carriages, and contains a boat-yard, iron-works, woolen factory and a manufactory for farming-tools. Population 1900, 3,457.

LEWISBURG, a town and the capital of Greenbrier County, southern central West Virginia, in a "blue-grass" region, nine miles from White Sulphur Springs, on the Greenbrier River, and on the Chesapeake and Ohio railroad. It is named for General Lewis, who was stationed at a fort here previous to the battle of Point Pleasant with the Indians. It is engaged in farming, stock-raising and some manufacturing. Population 1890, 1,016.

LEWISIA, a genus of plants of western North America, belonging to the family *Portulacaceæ* or purslanes. *L. redifolia* is a low, acaulescent, fleshy perennial, with fusiform roots, and occurring in masses. The leaves are narrow and clustered, and the flowers showy. The specific name refers to the fact that the thick roots are wonderfully tenacious of life.

LEWISTON, a post village, the former capital of Idaho, and now the county seat of Nez Percés County, situated at the confluence of the Clearwater and Snake rivers, at the head of steamboat-navigation. It has flour and shingle mills, and is a wheat-shipping port. Population 1900, 2,425.

LEWISTON, a city of southeastern Maine, on the Grand Trunk and the Maine Central railroads. It is the second city of the state in population. The most important manufactures are those of cotton and woolen goods, machinery, boots and shoes, jute bags, grain-sacks and brushes. The mills which manufacture these goods are worked by water-power, the water being conveyed to the mills by a canal. Lewiston has a public library, a large public park and auditorium. Population 1890, 21,701; 1900, 23,761. See LEWISTON, Vol. XIV, p. 495.

LEWISTOWN, a town and the capital of Fulton County, northwestern central Illinois, 48 miles N.W. of Springfield, on the Chicago, Burlington and Quincy and the Fulton County Narrow Gauge railroads. It has woolen, carriage, wagon, plow, spoke, can, duplex-scale and hub factories. Population 1890, 2,160; 1900, 2,504.

LEWISTOWN, a town and the capital of Fergus County, central Montana, 100 miles N.W. of Billings, on Big Trout Creek. It is in a farming,

mining and stock-raising region. Population 1890, 785; 1900, 1,096.

LEWISTOWN, a borough and the capital of Mifflin County, central Pennsylvania, at the mouth of Kishacoquillas Creek, on the Juniata River, and on the Pennsylvania railroad and canal. It has flour-mills, furnaces, ax factories, steel-works, and is noted as a shipping-point for iron, coal and grain. The surrounding mountain scenery attracts many summer visitors. It has an academy and a public library. Population 1890, 3,273; 1900, 4,451.

LEXICOGRAPHY. See DICTIONARY, Vol. VII, pp. 179-193.

LEXINGTON, a post-village of McLean County, northeastern central Illinois, on the Chicago and Alton railroad, 95 miles S. of Chicago. It is engaged largely in stock-raising, especially horses, and farming. It has large tile-works. Population 1890, 1,187; 1900, 1,415.

LEXINGTON, a city of northeastern central Kentucky, on the Chesapeake and Ohio, the Cincinnati, New Orleans and Texas Pacific, the Lexington and Eastern, the Southern and the Louisville and Nashville railroads. Hamilton Female College, Sayre Female Institute and St. Catherine's Academy are situated here. The city has large flouring-mills, distilleries, copper-works, and hemp, saddle and harness manufactories. It is the commercial center of the famous blue-grass region, and has a large trade in blooded horses and cattle, hemp, tobacco and Bourbon whisky. The Henry Clay Monument is one of the ornaments of the city. The city is supplied with water by the Holley system, and has gas and electric lights, electric street-railways, race-tracks, and a public library. Pop. 1890, 21,567; 1900, 26,369. See LEXINGTON, Vol. XIV, p. 494.

LEXINGTON, a village of Middlesex County, Massachusetts, 11 miles N.W. of Boston, containing a granite monument, erected on the village green, to commemorate the patriotism of those who fell in the first battle of the Revolution. On the night of April 18, 1775, 8,000 British regulars were secretly dispatched from Boston to arrest Samuel Adams and John Hancock at Lexington, and to seize the military stores collected at Concord. News of their approach was spread through the intervening towns by Paul Revere, and at daybreak, when the British arrived at Lexington, they found fifty minute-men drawn up on the village green. The advance-guard, under Major Pitcairn, fired upon them, but they held their ground until the main body of the British, under Lieutenant-Colonel Smith, appeared. They then gave way, and the regulars pushed forward to Concord. Here they were unable to discover any military stores, and while they were committing some depredations, affairs took a sudden turn. Two hundred regulars, who guarded Concord bridge, were routed by some 400 minute-men, who had hastily collected from neighboring towns. The position of the British thus became perilous. About noon they started for Boston, subjected to a galling fire from all sides. Exhausted by their march of eighteen miles and their fast of fourteen hours, they fell

into a disorderly flight, and were saved only by the timely assistance of Lord Percy, who came from Boston with a reinforcement of 1,200 and two cannon. Seven miles from Boston, their passage was for a while disputed by a force of militia.

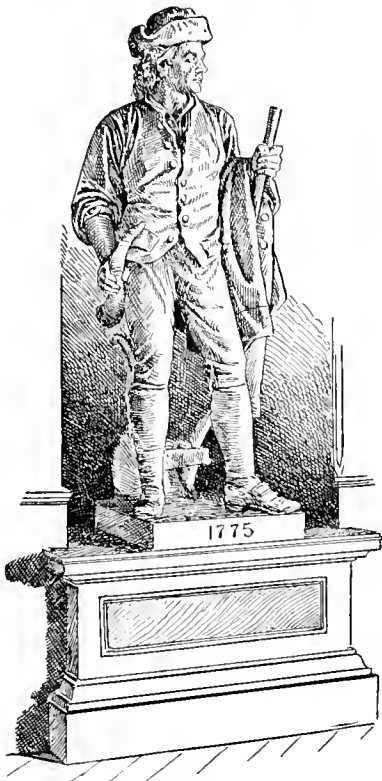

MINUTE-MAN, LEXINGTON.

The whole countryside was out against them; once more their retreat became a rout, and at sunset they entered Charlestown, under the welcome protection of the fleet, in full retreat, just in time to avoid an encounter with Colonel Pickering and 700 Essex militia. The loss of the British was 273, that of the Americans 93. Twenty-three towns were represented among the wounded and slain, and by the end of the week 16,000 men were besieging Gage in Boston. Population 1890, 3,197; 1900, 3,831. See also UNITED STATES, Vol. XXIII, p. 738, § 62.

LEXINGTON, a village and the capital of Holmes County, central Mississippi, 35 miles N. of Canton, on the Illinois Central railroad. It is the trade center of an extensive cotton-growing district. Population 1890, 1,075; 1900, 1,516.

LEXINGTON, a city and the capital of Lafayette County, central western Missouri, 40 miles E. of Kansas City, on the south bank of the river, and on the Missouri Pacific railroad. It has great commercial prosperity, having a very large river trade, has a wide strata of excellent coal underlying the town, is the center of a hemp-growing region, and has brick-yards and canning factories. It is noted for having been besieged three times during the Civil War—Sep-

tember, 1861; October, 1861; and October, 1864. It is the seat of Wentworth Military Institute and three female colleges. Population 1890, 4,537; 1900, 4,190.

LEXINGTON, a city of Dawson County, southern central Nebraska, 35 miles W. of Kearney, on the Union Pacific railroad and on the Platte River. It is the shipping-point of a fertile prairie farming region. It has banks and several newspapers. Population 1900, 1,343.

LEXINGTON, a village and the capital of Davidson County, western central North Carolina, on Abbott's Creek and on the Southern railroad, 15 miles N.E. of Salisbury. It has a shuttle and bobbin factory, cotton-mills, a foundry, machine-shop and flour-mills. It is in a lumbering, agricultural, and gold, silver and zinc mining region. Population 1900, 1,234.

LEXINGTON, a town and the capital of Rockbridge County, central western Virginia, situated in the fertile valley bounded on the southeast by the Blue Ridge, and known as the "Valley of Virginia." It is the western terminus of the James River and Kanawha canal; has immense water-power, and contains flour-mills and a foundry. It is near the Natural Bridge and the Peaks of Otter; is the seat of Washington and Lee University (q.v.) and of the Virginia Military Institute, and is the burial-place of Robert E. Lee and "Stonewall" Jackson. Population 1890, 3,059; 1900, 3,203.

LEYDEN JAR. SEE ELECTRICITY, Vol. VIII, pp. 5, 7, 34.

LEYDS, WM. JOHANNES, D. C. L., political agent since 1898 of the South African Republic, and since the Jameson Raid, in 1896, chief adviser of President Kruger, was born in Java in 1859 and educated at Amsterdam University. In 1884 he was appointed attorney-general and in 1888 state secretary of the Transvaal. During the year 1899, Dr. Leyds endeavored to win sympathy and aid in Europe for the Boer republic, and is understood to have acted as financial agent for it and its president at European capitals. In this capacity he continued throughout 1900 to act for the Transvaal and its authorities.

LIAS, formation. See GEOLOGY, Vol. X, pp. 354-357.

LIBEL, an injurious attack upon a man's reputation or character, by written or printed words or signs. Slander refers to the same injury by spoken words. The United States received the law of libel from England without material change, and with the exception of matters of detail and questions of practice administers it much in the same method as obtains in England. Some of our state constitutions declare that every citizen shall have unrestricted liberty to speak, write, and publish his sentiments on all subjects, and that in prosecutions for libel the truth of his assertions may be given in evidence, and shall be a defense if published with good motives and for justifiable ends. If, in any state, this privilege is not declared by the constitution, it is held to be a part of its common law; so that the right to

defend against a charge of libel, by showing that the publication was truthful and was made for justifiable ends, may be said to be guaranteed in all of the states. See also LABEL, Vol. XIV, pp. 505-507; and PRESS LAWS, Vol. XIX, pp. 710-714.

LIBERAL REPUBLICAN PARTY. See REPUBLICAN PARTY, in these Supplements.

LIBERAL-UNIONIST ASSOCIATION. An organization formed to resist the Home Rule policy adopted by Mr. Gladstone in 1886, and embodied in his two projects, the "Government of Ireland" and "Land Purchase (Ireland)" bills. Under the leadership of the Marquis of Hartington, afterward the Duke of Devonshire, and Mr. Joseph Chamberlain, one of the members for Birmingham, they allied themselves with the Conservatives on the Irish question in that year, and secured the defeat of Mr. Gladstone. The association has extended over the whole of the United Kingdom, and has upwards of 250 branches in England and Wales, besides those in Scotland and Ireland. For the purposes of better organization, a representative body, known as the Liberal-Unionist Council, was called into being, consisting of 94 members, the majority of whom are elected by the branch associations in all parts of the United Kingdom, the remainder acquiring their seats in the council by virtue of their official connection with the Liberal-Unionist party both in and out of Parliament. See also GREAT BRITAIN and HOME RULE in these Supplements.

LIBERIA (the United States of Liberia), a republic of Africa. The country has about 500 miles of coast-line, extending inland about 200 miles, with an area of about 32,954 square miles. The total population is now estimated at 1,068,000, of which 18,000 are Americo-Liberians, and 1,050,000 aboriginal inhabitants. Capital, Monrovia, with a population, in 1897, of 5,000. The other chief towns, with their populations, are Edina, 5,000; Buchanan, 5,000; Harper, 3,000; Robertsport, 1,200; and Sinoe (Greenville), 1,000.

The revenue in 1894 was \$158,861, and expenditure \$151,975. The revenue is derived chiefly from customs duties. The public debt, created in 1871 by a loan in England, with accrued interest (7 per cent, unpaid since 1874) is about \$1,350,000. The total exports and imports combined scarcely exceed \$2,500,000.

The constitution of Liberia is modeled after that of the United States. The President and House of Representatives are elected for two years, and the Senate for four years. There are now eight Senators and thirteen Representatives. The President of the republic must be 35 or more years of age, and must have property to the value of \$600. As chief executive he is assisted by an advisory Cabinet of five ministers, viz., secretaries of State, Treasury and Interior, and Attorney-General and Postmaster-General. For defense, every citizen from 16 to 50 is liable to serve, if capable of bearing arms; and in 1898 two small steel gunboats of 150 tons, armed with four Nordenfeldt quick-firing guns, were owned by the republic. See

also LIBERIA, Vol. XIV, pp. 508, 509; and AFRICA, in these Supplements.

LIBERTY, a post village and the capital of Union County, southeastern Indiana, situated on the Cincinnati, Hamilton and Dayton railroad, 43 miles N.W. of Cincinnati, Ohio. It has large flouring-mills, a factory of agricultural implements, planing-mills and stone quarries. The principal business in the vicinity is farming and stock-raising. Population 1900, 1,440.

LIBERTY, a post town and the capital of Clay County, western Missouri, 16 miles N.E. of Kansas City, on the Hannibal and St. Joseph and the Chicago, Milwaukee and St. Paul railroads, four miles N. of the Missouri River. It is the seat of William Jewell College (Baptist) and Clay Seminary for young ladies (non-sectarian). It contains flour-mills, wagon and plow factories, and ships wheat and live-stock. Population 1890, 2,558; 1900, 2,407.

LIBERTY, a station in Bedford County, Virginia, on the Norfolk and Western railroad, 25 miles W. of Lynchburg. See also BEDFORD CITY, in these Supplements.

LIBERTY, NATURAL. See POLITICAL ECONOMY, Vol. XIX, pp. 358, et seq.

LIBERTY, STATUE OF. See BARTHOLDI, and BEDLOE'S ISLAND, in these Supplements.

LIBERTY PARTY, THE, grew out of the Anti-Slavery Society, and was more widely known for the high character and persistent agitation of its adherents than for its numbers. In 1840 it nominated James G. Birney (see UNITED STATES, Vol. XXIII, p. 766), secretary of the Anti-Slavery Society, for President, casting 7,059 votes; and again in 1844, when he received 62,300 votes. It contained such men as Lewis Tappan, Gerrit Smith, Samuel Lewis and Salmon P. Chase. It merged into the Free-Soil party in 1848.

LIBOCEDRUS, a genus of coniferous trees, closely related to *Thuja*, the arbor-vitæ. The known species are natives of California, Chile, New Zealand, China and Japan. *L. decurrens*, the California species, is known as "white cedar." It is a beautiful tree, attaining a height of 120 to 200 feet, with a trunk 6 or 7 feet in diameter, and has a light, soft, durable wood.

LIBRA, Roman standard of weight; also same as AS, a copper coin. See WEIGHTS AND MEASURES, Vol. XXIV, p. 488.

LIBRA, sign of the ZODIAC (q. v.), Vol. XXIV, p. 791.

LIBRARIES, UNITED STATES. The public libraries of the United States since 1880 have been rapidly increasing in numbers, and by the returns of 1893, issued by the Bureau of Education, the libraries containing 1,000 volumes and upward were 3,804, aggregating about 31,000,000 volumes. Some of these libraries have been started and are maintained by subscription; others by private endowments; others again by state and municipal governments. The increase of municipal public libraries has been especially noticeable, the founding of libraries in the towns being encouraged by the legislatures of the respective

states, giving to the towns the right to levy a certain amount of taxes for this purpose, and by granting exemption from taxation to library property. In many places, too, libraries are established in connection with the public schools, under certain restrictions open to the residents of the town in which they are located, and aided in some instances by the state, as in New York, where the custom is to appropriate to any public school for library purposes as much as it can secure from other sources.

Among state libraries, that of New York, at Albany, still ranks first in the United States. In connection with it is a school for librarians. One of the unique features of this library is a sort of clearing-house, devised by Melvil Dewey, state librarian, which is used by all the libraries of the state of New York; its purpose is the utilizing of duplicates. Unnecessary books are sent to this clearing-house, where they are appraised by an official of the state library, and the senders may then select from the collection of duplicates, books of an equal value in money. Among the libraries recently established by private parties are the Newberry and Crerar in Chicago, and the Pratt in Baltimore. The cities of Boston, Chicago and St. Louis have recently completed new buildings for their public libraries, that in the latter city being of special magnificence, and ranking as one of the finest structures of the kind in the world.

The Congressional Library is growing yearly, and the United States Government is steadily increasing the department and bureau libraries, the most extensive of these collections being the library of the surgeon-general's bureau. The wise and generous provision, after years of delay, for a separate library building of the most ample dimensions, of absolutely fire-proof materials, and on a plan combining utility and beauty in a high degree, is most creditable to the judgment and liberality of Congress. The extent of accommodation for books is 4,500,000 volumes, and the limitation of cost \$6,000,000.

The Government encourages the growth of libraries, and renders them valuable service by allowing books for libraries to be imported free of duty and transported at a greatly reduced rate of postage, as well as by defraying the cost of foreign exchanges through the Smithsonian Institution. The government has further benefited the libraries of the country by printing at its own expense *The Proceedings of the National Academy of Sciences*; *Annual Reports of the American Historical Association*; and *Annual Reports of the Smithsonian Institution*.

College libraries in the United States are both large and numerous, yet while resembling in many of their functions the general public library, they differ in the fact that they are designed rather for purposes of reference than for general reading. Until within recent years the policy in colleges has been to confine the use of the library to the instructors; but the present tendency is to encourage the student to make the widest use of

the library, the idea having gained ground that it is an essential part of a liberal education to learn to use books. Indeed, brief courses in bibliography are now given as a part of the course of instruction in many colleges and universities. According to the returns of 1893 the number of volumes in the college libraries of the United States numbered 5,319,602. One of the largest college libraries recently established is that of the University of Chicago. Columbia College in 1895 received very large endowments for the erection and support of a new library building.

In some of the states, typically in New England and New York, laws exist encouraging the formation of town-libraries by the loan or gift of books, and even by small money appropriations. Under this inducement hundreds of country towns have become possessed of fair collections of books for reference and for circulation.

The present tendency in the administration of libraries is to give more attention to securing a large circulation of the books at hand than in making new acquisitions. The result has been to further every possible improvement by which books may be more accessible to the general public, by means of deliveries and branch libraries and by doing away with all red tape. One of the elements which has served also to bring about a more general use of the library is the growth of the educational movement known as university extension.

Catalogues are now generally upon the card system. The cards have on them the titles of the books, sometimes the subjects, and again the names of authors, thus making a threefold reference index. They are placed in compartments of a drawer for consultation. By this process the catalogue may be added to, changed, and kept complete for each addition to the library.

Many valuable ideas and suggestions were advanced in regard to libraries and their administration at a meeting of librarians held in Chicago in 1893. This "World's Library Congress," as it was called, was one of the congresses held in connection with the World's Columbian Exposition. The idea of a meeting of librarians, both of the United States and Europe, originated with Mr. Melvil Dewey, president of the American Library Association. Only three foreign representatives were present at the sessions of this congress, two from England and one from Germany. The program consisted of papers prepared by specialists relating to almost every phase of library administration. The reports of the congress were edited by Mr. Dewey.

The following list, taken from *Flint's Statistics of American Libraries*, issued in 1893, gives the location, name, year of founding, and number of volumes of all college and state libraries in the United States, and of all general libraries approximating 20,000 volumes and upward, with the addition of some of a smaller number but of a special nature, or when located in certain localities where the existence of even a small library has a special significance.

PLACE.	NAME OF LIBRARY.	FOUNDED.	NUMBER OF VOLUMES.	PLACE.	NAME OF LIBRARY.	FOUNDED.	NUMBER OF VOLUMES.
<i>Alabama.</i>				Washington	United States Geological Survey	1882	30,400
East Lake	Howard College	1841	10,000	Washington	United States Naval Observatory	1845	13,000
Montgomery	State and Supreme Court	1828	17,626	Washington	United States Senate	1870	72,500
Spring Hill	College	1829	15,000	Washington	War Department	1800	30,000
University	University of Alabama	1831	11,500	<i>Florida.</i>			
<i>Arkansas.</i>				Milton	Academy	1875	10,000
Little Rock	State	1846	51,000	<i>Georgia.</i>			
Marianna	Male and Female Institute		12,000	Athens	University of Georgia	1800	26,000
<i>California.</i>				Atlanta	State	1825	45,000
Alameda	Free Lib. and Reading Room	1876	10,500	Macon	Public Library and Historical Society	1874	12,000
Berkeley	University of California	1868	48,000	Savannah	Georgia Historical Society	1839	19,000
Los Angeles	Public	1872	25,000	<i>Illinois.</i>			
Oakland	Free Public	1868	10,700	Carbondale	Southern State Normal University	1874	10,000
Sacramento	State	1852	85,000	Champaign	University of Illinois	1867	20,500
Sacramento	Free Public	1879	18,500	Chicago	Chicago Historical Society	1856	20,000
San Anselmo	Theological Seminary	1871	18,000	Chicago	Chicago Law Institute	1857	24,600
San Francisco	Bancroft	1858	45,000	Chicago	Chicago Theological Seminary	1856	11,000
San Francisco	Bibliothèque de la Ligue Nationale Française	1875	13,000	Chicago	McCormick Theological Seminary		12,300
San Francisco	California State Min. Bureau	1880	10,000	Chicago	Newberry	1887	79,000
San Francisco	Free Public	1879	60,000	Chicago	Public	1872	175,800
San Francisco	Mechanics' Institute	1855	57,900	Chicago	University of Chicago	1890	380,000
San Francisco	Mercantile Library Asso.	1853	62,000	Evanston	Northwestern University	1855	24,000
San Francisco	Odd Fellows' Library Asso.	1854	42,500	Joliet	Joliet Business College	1866	12,000
San Francisco	St. Ignatius College	1855	30,000	Lake Forest	Lake Forest University	1859	11,000
San Francisco	San Francisco Law	1865	31,000	Monmouth	Monmouth College	1856	15,000
San Francisco	Sutro		200,000	Morgan Park	Baptist Union Theological Seminary	1867	25,000
Santa Clara	Santa Clara College	1851	18,000	Mount Morris	Mount Morris College		25,000
<i>Colorado.</i>				Peoria	Public	1880	43,000
Denver	Mercantile	1886	19,600	Rockford	Public	1872	19,500
Denver	State	1873	11,000	Springfield	State	1818	38,000
<i>Connecticut.</i>				Springfield	Public	1836	18,800
Bridgeport	Public	1881	21,700	<i>Indiana.</i>			
Hartford	Case Memorial		55,000	Bloomington	Indiana University	1820	14,600
Hartford	Connecticut Historical Soc.	1825	21,000	Crawfordsville	Wabash College	1833	30,000
Hartford	State	1854	15,000	Evansville	Willard Library	1885	18,000
Hartford	Hartford Library Association	1839	37,000	Greencastle	DePauw University	1838	12,600
Hartford	Hartford Theological Sem.	1834	55,000	Indianapolis	Indiana State Law	1867	17,000
Hartford	Trinity College	1823	33,000	Indianapolis	Indiana State	1825	20,800
Hartford	Watkinson	1858	43,800	Indianapolis	Public	1873	50,000
Middletown	Berkeley Divinity School	1854	21,000	Notre Dame	University of Notre Dame	1872	45,000
Middletown	Wesleyan University	1833	38,800	St. Mary's	St. Mary's Academic Institute		18,000
New Haven	Yale College	1701	185,000	St. Meinrad	St. Meinrad's Abbey	1854	15,000
New Haven	Linonian and Brothers	1769	28,000	<i>Iowa.</i>			
Waterbury	Silas Bronson	1870	44,000	Des Moines	State	1838	44,500
<i>Delaware.</i>				Grinnell	Iowa College	1838	17,000
Dover	State	1830	21,000	Iowa City	Iowa State University	1860	27,000
Wilmington	Wilmington Institute	1788	18,000	Iowa City	State Historical Society	1857	15,000
<i>District of Columbia.</i>				Mt. Vernon	Cornell College	1857	10,000
Georgetown	Riggs Memorial of Georgetown University	1889	61,000	<i>Kansas.</i>			
Washington	Department of Agriculture	1860	20,000	Baldwin	Baker University	1872	4,300
Washington	Department of Justice		21,500	Emporia	State Normal School	1863	6,800
Washington	Department of State	1789	50,000	Lawrence	University of Kansas	1866	16,200
Washington	Department of Interior	1849	11,500	Manhattan	State Agricultural College	1863	12,170
Washington	House of Representatives	1789	125,000	Topeka	State Historical Society	1875	12,900
Washington	Library of Congress	1800	650,000	Topeka	State	1862	27,500
Washington	Navy Department	1878	24,500	<i>Kentucky.</i>			
Washington	Post-Office Department	1862	10,000	Danville	Center College	1819	7,000
Washington	Patent Office	1836	50,000	Danville	Danville Theological Seminary	1853	10,000
Washington	Army Signal Office	1861	10,500	Frankfort	State	1821	80,000
Washington	Surgeon-General's Office	1865	104,000	Lexington	Kentucky University	1800	13,800
Washington	Treasury Department	1875	21,000				
Washington	United States Bureau of Education	1868	45,000				
Washington	United States Coast and Geodetic Survey Office	1832	12,000				

PLACE.	NAME OF LIBRARY.	FOUNDED.	NUMBER OF VOLUMES.	PLACE.	NAME OF LIBRARY.	FOUNDED.	NUMBER OF VOLUMES.
Louisville	Polytechnic Soc. of Kentucky	1879	50,000	Springfield	City	1857	79,000
Louisville	Southern Baptist Theo. Sem.	1859	16,500	Taunton	Public	1866	34,600
<i>Louisiana.</i>				Tufts College	Tufts College	1854	27,900
Baton Rouge	State University	1861	20,000	Waltham	Public	1865	19,000
Convent P. O.	Jefferson College	1865	15,000	Watertown	Free Public	1868	20,700
New Orleans	Public School and Lyceum	1844	17,000	Wellesley	Wellesley College	1875	30,300
New Orleans	State	1838	41,000	Williamstown	Williams College	1793	31,000
New Orleans	Tulane University	1884	13,500	Woburn	Public	1856	29,500
<i>Maine.</i>				Worcester	American Antiquarian Society	1812	95,000
Augusta	State	1820	40,000	Worcester	Free Public	1859	85,700
Bangor	Bangor Theological Seminary	1814	17,400	Worcester	Holy Cross College	1843	21,000
Bangor	Public	1883	31,000	<i>Michigan.</i>			
Brunswick	Bowdoin College	1794	49,000	Alma	Alma College	----	11,500
Portland	Public	1867	36,500	Ann Arbor	University of Michigan	1841	77,700
Waterville	Colby University	1820	27,700	Detroit	Public	1865	108,700
<i>Maryland.</i>				Grand Rapids	Public School	1861	26,000
Annapolis	State	1789	100,000	Holland	Hope College	1865	9,000
Annapolis	United States Naval Academy	1845	31,900	Kalamazoo	Public	1873	17,800
Baltimore	Enoch Pratt Free	1882	106,000	Lansing	State	1828	55,000
Baltimore	Johns Hopkins University	1876	55,000	Olivet	Olivet College	1846	19,000
Baltimore	Loyola College	1852	30,000	Ypsilanti	State Normal School	1853	11,400
Baltimore	Maryland Institute	1848	18,800	<i>Minnesota.</i>			
Baltimore	New Mercantile	1887	32,000	Collegeville	St. John's University	1870	9,000
Baltimore	Peabody Institute	1857	110,000	Hamline	Hamline University	1854	4,000
Baltimore	St. Mary's Theological Sem.	1791	26,000	Minneapolis	Public	1889	49,000
Woodstock	Woodstock College	1869	75,000	Minneapolis	University of Minnesota	1869	25,000
<i>Massachusetts.</i>				Northfield	Carleton College	1867	10,700
Amherst	Amherst College	1821	56,000	St. Paul	Macalester College	1885	4,800
Andover	Andover Theological Sem.	1807	48,700	St. Paul	Minnesota Historical Society	1849	21,000
Boston	American Academy of Arts and Sciences	1780	22,000	St. Paul	Public	1882	30,000
Boston	Boston Athenæum	1807	174,000	St. Paul	State Law	1849	20,700
Boston	Boston College	1863	20,000	<i>Mississippi.</i>			
Boston	Boston Library Society	1792	29,500	Agricultural	Agricultural and Mec'h'l Col.	1878	3,200
Boston	Boston Medical Library Assn.	1876	21,500	Jackson	State	1836	60,000
Boston	Boston Society of Natural His.	1830	21,000	University	State University	1848	13,000
Boston	Boston University	----	33,000	<i>Missouri.</i>			
Boston	Congregational	1853	30,000	C. Girardeau	St. Vincent's College	1844	12,000
Boston	Massachusetts Historical Soc.	1791	36,000	Columbia	University of Missouri	1840	20,000
Boston	Mass. Institute of Technology	1870	22,800	Rolla	Missouri School of Mines	1871	3,000
Boston	New England Historical Genealogical Society	1845	22,000	Glasgow	Lewis	1866	19,800
Boston	Public	1852	556,000	Jefferson City	State	1833	20,000
Boston	Social Law	1804	25,000	Kansas City	Public	1876	18,000
Boston	State	1826	73,000	St. Louis	Academy of Science	1856	16,000
Brookline	Public	1857	37,500	St. Louis	Christian Brothers College	----	11,000
Cambridge	Harvard University	1838	292,000	St. Louis	Law Library Association	1838	18,000
Cambridge	Law School	1817	28,000	St. Louis	Mercantile Library Association	1846	78,300
Cambridge	Museum of Comparative Zoölogy	1861	22,000	St. Louis	Missouri Botanical Gardens	1889	6,000
Cambridge	Public	1857	34,000	St. Louis	Public	1865	80,000
Fall River	Public	1861	39,000	St. Louis	St. Louis University	1828	30,000
Fitchburg	Public	1859	24,000	St. Louis	Washington University	1853	5,000
Lancaster	Town	1862	22,500	Springfield	Drury College	1872	20,000
Lawrence	Public	1874	34,000	<i>Montana.</i>			
Lowell	City	1844	44,000	Helena	State Historical	1865	4,000
Lowell	Middlesex Mechanics' Assn.	1825	21,000	Helena	Public	1886	8,700
Lynn	Public	1862	44,800	<i>Nebraska.</i>			
Malden	Public	1879	19,700	Crete	Doane College	1872	5,600
New Bedford	Public	1852	60,000	Lincoln	State	1867	22,800
Newburyport	Public	1854	28,000	Lincoln	State Historical Society	1878	4,600
Newton	Free	1869	34,700	Lincoln	State University	1870	17,000
Newton Cen-ter	Newton Theological Seminary	1825	19,000	Neligh	Gates College	1882	5,000
Northampton	Public	1860	24,000	Omaha	Creighton College	1879	7,000
Peabody	Peabody Institute	1852	30,000	Omaha	Public	1872	36,200
Pittsfield	Berkshire Athenæum	1871	18,500	Peru	State Normal School	1870	5,500
Salem	Essex Institute	1848	60,000	<i>Nevada.</i>			
Salem	Public	1880	23,000	Carson City	State	1865	2,000
Salem	Salem Athenæum	1810	20,000	Reno	State University	----	3,000

PLACE.	NAME OF LIBRARY.	FOUNDED.	NUMBER OF VOLUMES.	PLACE.	NAME OF LIBRARY.	FOUNDED.	NUMBER OF VOLUMES.
<i>N. Hampshire.</i>				<i>North Carolina.</i>			
Concord	New Hamp. Historical Soc.	1822	10,300	Chapel Hill	State University	1795	30,000
Concord	State	1810	30,000	Charlotte	Biddle University	1869	5,000
Hanover	Dartmouth College	1779	75,000	Davidson	Davidson College	1887	11,000
Manchester	City	1854	33,000	Raleigh	Supreme Court	1812	9,500
<i>New Jersey.</i>				Salem	Salem Female Academy	1802	5,000
Jersey City	Free Public	1889	19,800	Wake Forest	Wake Forest College	1834	10,700
Madison	Drew Theological Seminary	1868	27,200	<i>North Dakota.</i>			
Newark	Free Public	1888	31,000	Bismarck	State	1865	3,100
Newark	Library Association	1847	27,500	Bismarck	State University	1883	4,800
Newark	State Historical Society	1845	14,000	<i>Ohio.</i>			
New Brunsw'k	Rutgers College	1766	27,500	Akron	Buchtel College	1872	6,500
New Brunsw'k	Sage	1875	41,500	Athens	Ohio University	1804	21,000
Princeton	College of New Jersey	1750	84,200	Cincinnati	Hebrew Union College	1875	12,000
Princeton	Theological Seminary	1812	54,000	Cincinnati	His. and Philosophical Soc.	1831	11,800
Trenton	State	1822	38,500	Cincinnati	Lane Seminary	1833	16,700
<i>New Mexico.</i>				Cincinnati	Public	1867	156,700
Santa Fé	Territorial	1850	4,500	Cincinnati	St. Xavier College	1831	16,000
<i>New York.</i>				Cincinnati	Young Men's Mercantile Li- brary Association	1835	60,000
Albany	State	1818	157,000	Cleveland	Adelbert College	1826	25,000
Albany	State Law	1818	46,000	Cleveland	Case	1848	30,000
Albany	Young Men's Association	1833	21,000	Cleveland	Public	1868	67,000
Auburn	Auburn Theolog. Seminary	1821	19,600	Cleveland	Western Reserve His. Society	1867	11,000
Binghamton	Central High-School		64,200	Columbus	State	1817	63,500
Binghamton	Supreme Court	1859	8,800	Columbus	State University	1873	11,500
Brooklyn	Brooklyn Institute of Arts and Sciences	1823	13,400	Columbus	Public School	1890	19,500
Brooklyn	Brooklyn	1857	113,200	Columbus	State Law		14,000
Brooklyn	Free Lending	1882	20,700	Dayton	Public	1847	29,600
Brooklyn	Long Island Historical Soc.	1863	45,000	Delaware	Ohio Wesleyan University	1854	14,000
Brooklyn	Pratt Institute		40,000	Gambier	Kenyon College	1865	20,000
Brooklyn	Public School	1866	20,500	Gambier	Theological	1828	21,000
Buffalo	Buffalo Historical Society	1862	10,000	Hiram	Hiram College	1854	4,000
Buffalo	Buffalo	1836	66,700	Lebanon	National Normal University	1855	12,000
Buffalo	Grosvenor Public	1859	35,000	Marietta	Marietta College	1835	46,000
Clinton	Hamilton College	1812	35,000	Oberlin	Oberlin College	1833	24,000
Fordham	St. Johns College		36,000	Oxford	Miami University	1824	10,800
Geneva	Hobart College	1822	25,500	Springfield	Wittenberg College	1845	10,000
Hamilton	Colgate University	1820	21,000	Toledo	Public	1873	31,900
Ithaca	Cornell University	1868	111,000	Wooster	University of Wooster	1870	12,000
New York	American Mus. of Nat. His.	1880	23,000	<i>Oregon.</i>			
New York	American Soc. of Civ. Eng'rs	1852	15,000	Eugene	State University	1876	3,900
New York	Apprentices'	1820	90,300	Forest Grove	Tualatin Academy and Pacific University	1853	6,000
New York	Association of the Bar	1870	40,000	Portland	Library Association	1864	19,300
New York	Astor	1848	239,000	Portland	State	1850	17,000
New York	Col. of the City of New York	1852	26,700	<i>Pennsylvania.</i>			
New York	College of St. Francis Xavier		30,000	All gheny	Western Theological Semin'y	1872	25,000
New York	Columbia College	1754	135,000	Allentown	Muhlenberg College	1867	9,500
New York	Cooper Union	1857	31,900	Beatty	St. Vincent	1826	40,000
New York	Gen. Theological Seminary	1822	21,000	Bryn Mawr	Bryn Mawr College	1885	9,700
New York	Lenox	1870	65,000	Collegeville	Ursinus College	1870	4,500
New York	Maimonides	1851	33,000	Easton	Lafayette College	1832	23,000
New York	Masonic	1870	12,000	Gettysburg	Theological Seminary	1826	12,500
New York	Mercantile Library Asso.	1820	240,000	Gettysburg	Pennsylvania College	1832	10,500
New York	New York Academy of Med.	1847	30,000	Harrisburg	State	1790	60,000
New York	New York Free Circulating	1880	58,000	Haverford	Haverford College	1833	28,000
New York	New York Historical Society	1804	75,000	Lancaster	Franklin and Marshall College	1853	4,000
New York	New York Hospital	1790	20,000	Lancaster	Theological Seminary	1825	11,000
New York	New York Law Institute	1828	40,600	Lebanon	Normal University	1855	12,000
New York	New York Society	1754	90,000	Lewisburg	Bucknell University	1846	12,000
New York	Union Theological Seminary	1836	67,000	Lincoln Uni- versity	Lincoln University	1854	14,000
New York	Univer. of City of New York	1833	18,000	Meadville	Allegheny College	1820	12,000
New York	Young Men's Christian Asso.	1852	39,500	Meadville	Meadville Theological School	1844	23,000
Poughkeepsie	Vassar College	1861	18,000	Overbrook	Sem. of St. Charles Borromeo	1832	22,000
Rochester	Public	1863	19,500	Philadelphia	Academy of Natural Sciences	1812	33,000
Rochester	Reynolds	1884	22,700	Philadelphia	American Philosophical Soc.	1743	46,000
Rochester	Theological Seminary	1850	25,200	Philadelphia	Athenaeum	1814	35,000
Rochester	University of Rochester	1850	26,200	Philadelphia	College of Physicians	1787	42,000
Schenectady	Union College	1798	37,300				
Syracuse	Central	1855	22,300				
Syracuse	Syracuse University	1872	40,000				
Troy	Young Men's Association	1835	20,000				



PLACE.	NAME OF LIBRARY.	FOUNDED.	NUMBER OF VOLUMES.
Philadelphia	Franklin Institute.....	1824	37,000
Philadelphia	German Society.....	1817	22,000
Philadelphia	Hahnemann Medical college	1848	8,000
Philadelphia	Historical Society of Penn....	1824	28,000
Philadelphia	Law Association.....	1802	25,000
Philadelphia	Library Company.....	1731	165,500
Philadelphia	Mercantile Library Company	1821	166,000
Philadelphia	Mutual Library Company....	1879	43,400
Philadelphia	Pennsylvania Hospital.....	1765	14,800
Philadelphia	Presbyterian Historical Soc'y	1852	20,000
Philadelphia	Theological Seminary.....	1864	18,200
Philadelphia	University of Pennsylvania....	1749	100,000
Pittsburg	Library Association.....	1849	22,000
So. Bethlehem	Lehigh University.....	1877	66,800
State College	Pennsylvania State College....		7,300
Swarthmore	Swarthmore College.....	1864	9,900
Washington	Washington and Jefferson Col.	1798	10,000
<i>Rhode Island.</i>			
Newport	People's.....	1870	30,000
Newport	Redwood.....	1747	37,700
Providence	Brown University.....	1767	71,000
Providence	Providence Athenæum.....	1836	52,000
Providence	Public.....	1878	58,700
Providence	State Law.....	1868	12,000
<i>South Carolina.</i>			
Charleston	Charleston Library Society....	1748	19,000
Columbia	Smyth Library and Seminary	1831	22,000
Columbia	State.....		36,000
Columbia	South Carolina College.....		27,000
Spartanburg	Wofford College.....	1854	8,000
<i>South Dakota.</i>			
Redfield	Redfield College.....		3,000
Yankton	Yankton College.....	1881	4,300
<i>Tennessee.</i>			
Clarksville	Southwestern Presbytr'n Uni.	1879	6,000
Knoxville	State University.....	1807	6,200
Lebanon	Cumberland University.....	1842	8,000
Maryville	Maryville College.....	1819	12,000
Nashville	State.....	1854	30,000
Nashville	University of Nashville.....	1806	11,000
Nashville	Vanderbilt University.....	1875	13,000
Sewanee	University of the South.....	1869	27,500
<i>Texas.</i>			
Galveston	Public.....	1882	7,600
Sherman	Austin College.....	1851	5,500
<i>Utah.</i>			
Salt Lake City	City.....	1850	5,000
Salt Lake City	State University.....	1874	8,000
Salt Lake City	State.....	1852	4,000
<i>Vermont.</i>			
Burlington	Fletcher Free.....	1873	25,000
Burlington	State University.....	1791	43,400
Middlebury	Middlebury College.....	1800	16,500
Montpelier	State.....	1825	26,000
Vergennes	Vergennes.....	1876	22,200
<i>Virginia.</i>			
Ashland	Randolph Macon College.....	1830	8,000
Emory	Emory and Henry College....	1837	8,000
Hampden			
Sidney	Union Theological Seminary	1825	12,400
Lexington	Virginia Military Institute....	1839	14,000
Lexington	Washington and Lee Univ....	1796	25,000
Richmond	Richmond College.....	1832	11,400
Richmond	Virginia Historical Society....	1831	13,000
Richmond	State.....	1823	50,000
Salem	Roanoke College.....	1853	18,000

PLACE.	NAME OF LIBRARY.	FOUNDED.	NUMBER OF VOLUMES.
Theolog. Sem.	Theological Seminary.....	1823	18,000
Univ. Station	University of Virginia.....	1819	45,000
Williamsburg	College of William and Mary	1693	7,000
<i>Washington.</i>			
Olympia	State.....	1856	16,000
Walla Walla	Whitman College.....	1882	3,800
<i>West Virginia.</i>			
Charleston	State.....	1863	6,000
Morgantown	State University.....	1867	5,000
<i>Wisconsin.</i>			
Appleton	Lawrence University.....	1854	12,600
Beloit	Beloit College.....	1847	17,200
Madison	State Historical Society.....	1854	72,000
Madison	State University.....	1850	22,800
Madison	State.....	1836	24,700
Milwaukee	Public.....	1878	61,000
Racine	Racine College.....	1853	10,000
Ripon	Ripon College.....	1863	6,700
St. Francis	Provincial Seminary.....	1856	13,000
<i>Wyoming.</i>			
Cheyenne	State Law.....	1869	14,000
Laramie	State University.....	1887	2,300

LIBURNIA. See LIBURNIANS, Vol. XIV, p. 551.

LIBYANS. See CARTHAGE, Vol. V, p. 160.

LICATA or ALICATA (q.v., Vol. I, p. 574).

LICENSE, in general, a right or permit given by competent authority authorizing the person to whom it is issued to do an act or a series of acts which it would be illegal for him to do without such permit. A license may be either oral or in writing. Various licenses are described under the following headings: GAME LAWS, Vol. X, p. 62; GOTHENBURG, *ib.*, p. 846; LIQUOR LAWS, Vol. XIV, pp. 688-690; MARRIAGE, Vol. XV, p. 567; NEWSPAPERS, Vol. XVII, p. 414; PATENTS, Vol. XVIII, p. 356; POLICE, Vol. XIX, p. 335; PRESS LAWS, *ib.*, p. 710; and THEATER, Vol. XXIII, pp. 227, 228. In general, modern licenses are survivals of MONOPOLY (q.v., Vol. XVI, p. 758).

LICHEN, skin affection. See SKIN DISEASES, Vol. XXII, p. 122.

LICHENINE. See LICHENS, Vol. XIV, pp. 558, 559.

LICHI. See LITCHI, in these Supplements.

LICINIO, GIOVANNI A. See PORDENONE, Vol. XIX, p. 519.

LICK, JAMES, an American philanthropist, the founder of the great California observatory known by his name, was born in Fredericksburg, Pennsylvania, Aug. 25, 1796. After spending many years in South America he settled in California in 1847, and there amassed an immense fortune. Though generally regarded as a man of solitary and avaricious habits, in 1874 he assigned real and personal property, valued at about \$3,000,000, to seven trustees, to be applied to various public and charitable enterprises. Before his death several changes in his deed of trust were made and new trustees designated,

but the provisions finally set apart \$60,000 for the erection of a monument in Golden Gate Park to Francis Scott Key, author of the "Star-Spangled Banner;" \$100,000 for the erection of a group of bronze statuary in front of the City Hall, San Francisco, representing the history of California; \$150,000 for the erection and support of public baths in San Francisco; \$100,000 to found an Old Ladies' Home in San Francisco; \$540,000 to found and endow the California School of Mechanical Arts; and \$700,000 for constructing an observatory and erecting therein a more powerful telescope than had ever been made, the observatory to become a part of the University of California. Mr. Lick died Oct. 1, 1876, and in 1887 his remains were placed in a vault at the base of the 30-foot pier supporting the great telescope.

LIDDON, HENRY PARRY, an English clergyman, was born Aug. 20, 1829, at Stoneham, Hants; graduated in 1850, at Christ Church, Oxford; took holy orders in 1854; vice-principal of the theological school at Cuddesdon; prebendary of Salisbury Cathedral (1864-70); resident canon of St. Paul's, London (1870-90); professor of biblical interpretation at Oxford (1870-82); thrice select preacher, and once Bampton lecturer at the same university; died suddenly, Sept. 9, 1890, at Weston-super-mare.

Canon Liddon was regarded in England as one of the foremost of pulpit-orators, and many flocked to hear his sermons at St. Paul's. He was a champion of advanced Anglican views, which were not acceptable at court and stood in the way of his preferment. His sermons have been collected into several volumes. His best work was his Bampton lectures, published as *The Divinity of Our Lord and Saviour, Jesus Christ*, a book that was several times reissued. Many were looking to him, as the most competent person, for a life of Dr. Pusey, on which he was known to be engaged, but he left it unfinished. However, other hands took up his material and plans, and in 1896 the third of four volumes, entitled *Life of Edward Bouverie Pusey*, was published as the work of Canon Liddon. The Canon's *Letters from Egypt and Syria* appeared posthumously in 1891.

LIE, JONAS LAURITZ EDEMIL, a Norwegian novelist; born at Eger, near Drammen, June 11, 1833. He spent his youth at Tromsø, a town and island in Finmark. He prepared to enter the navy, but being compelled by near-sightedness to give this up, he turned his attention to the law; after practicing for some years at the little town of Kongsvinger, he moved in 1868 to Christiania, and devoted himself entirely to literature. He has spent a great deal of time in travels, and for 12 years preceding 1893 was absent from Norway altogether, but in the latter year he returned to his native land.—His wife, THOMASINE HENRIETTE LIE, has been a steady co-worker in his literary productions.—Among his novels are *Den Fremsynte* (1870); *Adam Schrader* (1879); *Livsløven* (1883); *Familjen paa Gilje* (1883); *En Malström* (1884); *Niobe* (1893). He wrote two dramas, *Faustina Strozzi* (1875) and

*Grabows Kat* (1880). See also *Literature*, under NORWAY, Vol. XVII, p. 592.

LIEBKNECHT, WILHELM, a German socialist, was born at Giessen, Mar. 29, 1826, and died at Charlottenburg, Aug. 6, 1900. His education was received at his native city and Berlin. Involved in the revolutionary uprisings of 1848, and condemned to death, he fled to Switzerland and England, in which countries he lived a long time. Returning to Germany without permission, he was imprisoned. When finally released, a seat was found for him in the Reichstag by his admirers. In company with Bebel, he was immured for two years in the fortress of Hubertsburg from 1872. He was later chosen to represent Berlin in the Reichstag, and became editor of *Vorwärts*, the principal Socialist daily paper in Germany.

LIEN. See AGENT, Vol. I, pp. 280-281; LIEN, Vol. XIV, pp. 569-570; INNKEEPERS, Vol. XIII, p. 82; and SALE, Vol. XXI, pp. 205-210.

\* LIFE INSURANCE IN THE UNITED STATES. Life insurance is peculiarly adapted to the genius and institutions of the people of the United States. Commencing practically in 1843, when the Mutual Life Insurance Company of New York issued its first policy, the business has had a marvellous growth until it now exceeds, in the amount of insurance in force, that of all other countries combined.

According to the latest official returns, the insurances in force in the regular or level-premium companies in the United States and Great Britain were as follows: In the United States, Jan. 1, 1896, \$6,617,508,355; in Great Britain, latest returns, £658,170,728; or, counting \$4.84 to the pound sterling, \$3,185,546,324.

The statistics for companies in the United States are compiled from the official returns of these companies to the insurance departments. The statistics for those of Great Britain are compiled from *Bourne's Insurance Directory*, published in 1896.

The regular companies in the United States, as contra-distinguished from co-operative or assessment associations and from beneficial organizations, such as Odd-Fellows, Masonic, trades unions and other fraternal societies, were, on Jan. 1, 1896, 55 in number, with assets amounting to \$1,165,426,149; surplus of \$163,983,129; income in 1895, \$273,691,282; and the payments to policy-holders the same year, \$126,360,612.

The outstanding insurances Jan. 1, 1896, in assessment companies, were about \$7,500,000,000; in the various beneficial and fraternal societies probably as much more, although in the absence of official returns it is impossible to give exact figures.

Prior to 1843 there were but few life insurance companies in the United States, and the amount of business was quite insignificant. It is interesting to note, however, that the oldest company in the world confining its business strictly to insurances upon lives and annuities is the Presbyterian Ministers' Fund of Philadelphia. This company, organized in 1759, or three years prior to

the celebrated Equitable of London, has been steadily pursuing its business from that year to the present—or for 137 consecutive years. It is in a healthy and prosperous condition, although its business, confined to insurances upon the lives of Presbyterian ministers, is necessarily very small. It is believed that this little company was the first to recognize the right of policy-holders in case of discontinuance to surrender-values for their over-payments, a right which is conceded almost universally now by the companies and enforced by the statutes of many states. In 1852 this company inserted the following clause in its policies: "Should the assured at any time desire a cancellation of the policy, an estimate will be made of the value thereof, on life-insurance principles, and the amount will be credited as a single payment for the assurance of a single sum payable on the death of such minister, or at his request, and at the election of the corporation may be repaid to him, deducting five per cent."

In June, 1860, the New York Life Insurance Company began the issue of ten-payment whole-life policies with the guaranty of a paid-up policy for a proportionate amount in case of lapse after two annual premiums had been paid. This commendable course has since been followed by all other American companies.

Not only has the business of life insurance had a phenomenal growth in volume during the past fifty years, but it has improved greatly in quality. In the earlier years the contracts were iron-clad, and, to say the least, were very favorable to the companies. If the insured was unable or unwilling to pay a stipulated premium, the policy and all premium payments were usually forfeited to the company. Harsh restrictions and penalties were imposed in case of travel, residence or occupation, which were assumed to involve extra hazard. The companies of late years have been in keen competition in the race for liberal concessions to the assured. At the present time, in many companies there are few or no restrictions in regard to residence, travel, occupation, and, after one or more years, even as to suicide. One company has gone so far as to agree that the prompt payment of premiums is the sole requisite for the prompt payment of the insurance, without other conditions. There is, of course, danger in such extremes of liberality, but it is sought to be justified by the general truth that life insurance is safe or possible only on the general hypotheses that, to the average man, life is more precious than money; that the insured has a greater interest in his own life than the company has; and that he may be trusted to take care of it. Like all general truths, this one may have exceptions, and the danger is rather in too great liberality than in too great caution on the part of the companies.

In the earlier years of American life insurance, companies were obliged to rely upon foreign tables of mortality, and the standard of valuation adopted almost universally in the United States was the English Carlisle table. Statistics of

mortality in American companies were carefully gathered, and in 1859 was published the so-called American Experience Table, compiled by the writer chiefly from the rates of mortality which prevailed among the insured in the Mutual Life Insurance Company of New York. This table first demonstrated the fact that the rates of mortality among insured lives in the United States, while higher at younger and older ages than among similar insured lives in Great Britain, were lower at the middle ages, say from thirty to sixty, during which period nearly all the insured were included. This proved that American companies were on a safe basis as regards the mortality rates assumed. The American Experience Table at once commanded confidence, and was soon adopted as the official standard for premiums and valuations of insurance contingencies by nearly all the companies and by nearly all the states. It is still the best index of the relative mortality at the several ages which has been experienced in the past, and which may be expected to prevail in the future among American insured lives.

In the earlier years the surplus of life-insurance companies was divided among their members in proportion to the premiums paid by each. This was a most unequal and unsatisfactory method. In 1862 the contribution plan of dividing surplus was devised by the writer and his assistant at that time, Mr. D. P. Fackler, and was applied in the following year to the distribution of the surplus of the Mutual Life Insurance Company of New York. By this plan the individual contributions to surplus from favorable mortality, from higher interest and from economy in expenses, are ascertained separately, and the surplus divided in proportion to the individual contributions thereto. The contribution plan at once superseded the old methods, and has been adopted very generally by American companies.

In the earlier years surplus was usually divided at infrequent intervals, usually once in five years, and was applied either to purchase additional insurance payable with the policy, or toward the cancellation of premium notes when these were accepted by the companies. In time, however, the surplus was divided annually, and could, at the option of the assured, be applied either to increase the insurance, to reduce the premium, or be withdrawn in cash.

There is one specialty in American companies which is worthy of attention, and that is the very large amount of insurance written upon Tontine plans. Tontine insurance, as now written, is simply an agreement by which surplus is retained and accumulated for the exclusive benefit of those policy-holders who survive and keep their policies in force until the end of the tontine period agreed upon—generally ten, fifteen or twenty years. Upon ordinary plans the surplus is divided annually; upon both plans the full sum insured is always payable at death.

Life insurance is, in effect, an arrangement or device by which the pecuniary loss to family or

dependents which would result from the death of their protector, is borne by a large number of associates, upon each of whom the burden or loss falls but lightly. In the case, however, of a person who dies after paying one premium, or only a small number of premiums, the pecuniary gain to his beneficiaries is abnormally great, since the amount of insurance is very large in comparison with the premiums paid therefor. To pay dividends, in addition to the insurance in such cases, only aggravates the relative inequality between persons dying early and those who live longer and pay premiums for many years. The Tontine system, by awarding and paying surplus to the latter class only, equalizes these otherwise unavoidable and unforeseen inequalities. Moreover, each person should be allowed full liberty in the choice of different forms of insurance, and so-called Tontine companies issue all kinds. The fact that such a large number of applicants prefer and select Tontine policies may be considered a proof of the confidence of the companies and of their patrons in the system. In the volume of business, the Tontine companies surpass by far the companies which refuse to issue that class of policies. Incidentally it is claimed that lapses are fewer among Tontine than among ordinary policies, and that there is a great advantage to those who survive the Tontine period in the opportunity of closing their contracts and of receiving their full equities, both of reserve and surplus, in cash or in paid-up insurances, or of continuing their policies with greatly reduced premiums.

In one respect life insurance in the United States differs in a remarkable degree from that in Great Britain, and, in fact, from that in all other countries. Each of the United States, in the absence of legislation by the national government, has sovereign power to impose such restrictions, conditions and taxes, however onerous or oppressive, as it may see fit, upon corporations of every other state seeking to do business within its precincts. Each state has its own insurance department and its own statutes regulating life insurance. In consequence, the policy-holders of life insurance companies are subjected to hazard, inconvenience, danger and expense by reason of diverse and oftentimes incongruous legislation. The burdens imposed upon the management of our life-insurance companies by reason of the requirements of the different states, and of the necessity laid upon them to protect the interests of the policy-holders by guarding them against unfavorable and unwise legislation, is very serious.

The business of life insurance in the United States is usually conducted on the mutual plan. The members of a mutual life-insurance company constitute a society, and each member is at once insurer and insured, entitled to participate in the management, and share in the profits in proportion to his interest.

A life-insurance company essentially consists of a trust fund, and the proper administration of such a fund demands *equality* between the bene-

ficiaries. As the policy-holders, the sole beneficiaries of such a trust fund, reside in different states, the necessity of uniform laws for the administration of the trust inheres in its very nature. The rights of a beneficiary residing in one state in the administration of such a trust should be determined by the same law which governs those of his fellow-beneficiaries residing in other states. Any discrimination in favor of a beneficiary residing in one state would impair the vested rights of beneficiaries residing in other states. Uniform law for life insurance is demanded precisely as in the case of the administration of the Peabody trust fund, where the statutes of one state govern its transactions in all other states. Uniform, stable and just law is an absolute essential to safety and success in the administration of the business of life insurance.

In striking contrast with the American system of state supervision by legislative enactments, is the system adopted in Great Britain. There the companies are required simply to file with the Board of Trade sworn statements as to the amount of assets, of income and of liabilities, giving the table upon which such liabilities are computed; and the public is left to find out their relative merits or standing by such illumination as active competition and public information may afford. No attempt at supervision of companies is made, and in Great Britain no tax is laid upon life insurance. There it is assumed, and very justly, that life insurance is a public benefaction; that it tends to promote thrift and economy on the part of its citizens and to avoid the burden of paupers upon the state, and that as such it should be fostered and encouraged by every proper means.

In other words, life insurance in the United States is the subject of supervision and tax by each separate state, while in Great Britain publicity and natural competition are relied upon to keep the companies in sound condition. The two methods are in sharp contrast. It cannot be denied that the American system has one advantage in the complete published returns, even to the minutest detail, of its items of assets, liabilities and methods of business, which are open to the inspection of the public. American companies are thus enabled to dispel honest doubts and disarm designing criticism by the simple logic of facts, and to demonstrate beyond question their claim to the confidence of the community.

While there have been in former years failures among life-insurance companies in the United States, they may all be attributed to inexperience in management or to extravagance in expenditures. In no single instance can a failure be attributed to defects in the principles upon which this system rests and to which it owes its claim to the confidence of the community. These principles are based upon science and sound business experience, and are likely to endure.

Notwithstanding the failures which have occurred among former weak and unsound life-insurance companies, the loss to the public has been

small compared with that in other branches of business.

The following statistics regarding the regular life-insurance companies doing business in New York, from the dates of their respective organizations to Dec. 31, 1892, are compiled from the thirty-fourth annual report of the New York Insurance Department:

Paid policy-holders-----	\$1,529,578,279
Assets on hand-----	993,734,537=\$2,433,312,816
Total premiums received-----	2,281,934,040

Excess of premium receipts acc'd for-- \$ 151,384,776

The former superintendent of the New York Insurance Department well said in his annual report for 1884, referring to the administration of life-insurance companies: "Never was there presented anywhere a statement of trusteeship accounting that equals this, and it needs but publicity to silence the doubts of those who have been prejudiced by the failures that have occurred in the business. The losses occasioned by these failures, unfortunate as they were, are insignificant when compared with the great benefits conferred by the solvent companies in the return to the policy-holders and their beneficiaries of the amount shown by the preceding statistics."

SHEPPARD HOMANS.

**LIFE-SAVING APPARATUS.** The devices mainly depended upon by life-saving crews are the breeches-buoy, the Lyle gun, the life-car and the lifeboat. The breeches-buoy consists of a pair of canvas breeches, with a buoyant ring around the top, and tackle for attaching it to run on a life-line, as between a wrecked vessel and the shore. The Lyle gun, invented by Captain David A. Lyle, United States of America, is of bronze, and weighs, with its line-carrying projectile, a little more than two hundred pounds. Its range is about seven hundred yards. The life-car used in the United States service is boat-shaped, double-ended, and has a small hatch which may be fastened either from the inside or outside. It is designed to run on the life-line, when the seas are so heavy as to make the use of the breeches-buoy difficult, or for transporting women, children or sick persons from a wreck. With these and the common lifeboat, the crews of the United States life-saving service have reduced the deaths by shipwreck during the past twenty-five years to less than seven per cent of the loss during the previous twenty years. Only one shipwrecked person out of 84 is the average of those drowned on the United States coasts where the service is maintained.

The Royal Lifeboat Institution of Great Britain in 1891 built a jet-propelled lifeboat named the *City of Glasgow*, which proved so successful that another, somewhat larger, has been built for the National Lifeboat Institution of Holland. The system of jet-propulsion has not been looked upon with favor by mariners and naval experts, but in this instance it proves serviceable. The *Glasgow* has 200-horse-power engines driving

a centrifugal pump arranged to run only in one direction. There are no paddle-wheels or screw-propellers, the propulsion being effected by the discharge of water-jets located at about the center of the vessel. The discharge-streams can be driven in any direction, serving to steer as well as to drive the boat. There is also a rudder, but it need not be used except in case of emergency. The discharge-streams are under the control of the steersman, who may adjust them at any angle, or even turn them straight outward, by means of controlling valves. By directing one forward and the other backward, he can turn the boat around within a circuit of the diameter of its own length, a maneuver not possible with any other form of propulsion. By reversing the jets the vessel can be stopped from full speed in twenty seconds. It is this exceeding quickness of maneuvering which has made this form of propulsion acceptable in the life-saving service. The Holland boat is built entirely of steel, and is 55 feet all over, 13½-foot beam, and 5½ feet deep, drawing 3¼ feet of water. The engines are 250 horse-power.

Numerous life-arrows, kites and similar devices have been invented to carry lines to wrecked vessels, but none has proved superior to the Lyle gun. Various circular life-buoys are in use, some of them capable of sustaining a dozen or more persons in the water. The life-raft is in use on most modern steamboats of any size. It consists usually of two parallel double-pointed steel cylinders, filled with air, and connected by a framework that forms the floor of the raft. Passenger vessels uniformly carry life-preservers, the common form being a sort of jacket containing cork floats sewed in around the body.

C. H. COCHRANE.

**LIFE-SAVING SERVICE, UNITED STATES.** This service, under the present system, has been in existence since 1871. It is an organization for the succor and rescue of seafarers subjected to shipwreck upon the sea and lake coasts of the United States. With the exception of about fifty stations supported by the Danish government, mainly on the coast of Jutland, and a few on the coast of Belgium, the life-saving service of the United States is the only government establishment of the kind in the world. It is distinguished not only by its uniqueness and magnitude, but also by the extraordinary success which has attended its efforts to save life and property upon occasions of maritime disaster. This service is under the control of the United States Treasury Department. It includes all points of danger on nearly ten thousand miles of coast, divided into twelve districts. A general superintendent presides over the organization, who, with his assistant, has his headquarters in the Treasury at Washington. There is an inspector of life-saving stations at New York, and there are two superintendents of construction for the Atlantic and lake coasts and two for the Pacific, who supervise the building and repairs of the stations and purchase their

equipments. An officer of the revenue marine acts as assistant or local inspector in each district. He sees that the stations are kept in proper order and the crews well practiced in the use of the life-saving appliances. Besides the local inspector, there is, in each district, a superintendent, who manages its affairs, under the direction of the general superintendent. At each life-saving station there is a keeper, who must be an expert surfer. He is, by law, an inspector of customs, and has power over all stranded property. Under him is a crew of seven experienced surfmen. These men have to patrol a certain beat every night, and during foggy days. On these patrols they look out for vessels in danger or distress. For the proper watching of the coast the station-men are divided into four watches, of two men in each, and each man is provided with a beach-lantern and pouch of Coston signals, which are cases of combustibles, capable of being lighted at will by percussion. The first watch leaves the station at sunset. One of the two men composing the watch goes to the left, the other to the right. Each one marches on until he meets the patrolman of the adjacent station in his direction. After exchanging metal checks (suitably inscribed) each patrolman returns to his station, and presents his check to the keeper as proof of the performance of his duty. Then a second watch sets out and goes over the same ground, then a third; and so on until the night is passed. This constant patrolling of desolate coasts on dark nights and foggy days is often a very severe task, but it is faithfully performed.

The stations usually are two-story wooden houses containing six or seven rooms. They are well supplied with all life-saving appliances, and also are fitted up for the residence of the crews. On dangerous coasts, where wrecks are frequent, they are only about five miles apart. Most of them are now connected by telephone. At many of them a team of horses is kept, in order to lighten the labors of the men in moving heavy apparatus to the places where rescues have to be made.

The mode of service at wrecks is as follows: When a vessel is driven ashore by day, she is seen by the station-lookout, who is on top of the house. If it is by night, the patrolman walking along the coast descries her struggling in the breakers, and he at once ignites his Coston lights. These lights emit a brilliant red flare of about two minutes' duration. This notifies the persons on board that they have been seen and that assistance is near. The patrolman then hurries to the station, where he reports to the keeper. The latter then hastens with his crew and a wagon-load of apparatus to the assistance of the distressed vessel. Sometimes the large lifeboat is launched, at other times the lighter surfboat is hauled overland to a point opposite the wreck, and there launched. The keeper, being the commander and the steersman of the boat, he has to decide what course of action must be pursued. When he reaches the vessel, women, children, helpless persons and pas-

sengers are first taken into his boat—no scrambling, pushing or pressing is allowed on such occasions—and the wrecked crew and officers are shipped last. Baggage or goods are not allowed to be taken into the rescuing boat until every living person has been landed.

Should the sea be so turbulent that no boat can live in it, the method of rescue by means of the wreck-ordnance is resorted to. A line attached to the shot of the wreck-gun is fired over and across the wrecked vessel. Pulling on this line, the people on the wreck haul on board a rope, without ends, and finally get a tail-block, which has a whip-line rove through it. They fasten the tail of the block to a mast of the wrecked vessel, or to any other firm portion of the hull situated well up. Next the hawser is pulled on board in a similar way, and fastened to the mast, above the other rope. The shore end of the hawser is drawn over an upright crotch or shear-legs, guyed or braced to a sand-anchor in its rear. When all is ready, the wrecked people are brought ashore, either one by one in the breeches-buoy, or six at a trip in the life-car. The latter is seldom used on our coasts, the breeches-buoy and surf-boats being employed generally. For illuminating the beach during the wrecking operations, the surfmen suspend a so-called "sausage-light" from a tripod on shore. Immediately upon being landed the rescued people are conveyed to the station, and there they are cared for until they are able to help themselves. Besides the saving of life, the rescue of property is a conspicuous though secondary feature of the service. The surfmen are experts in floating stranded vessels, extricating them from dangerous situations, relieving leaking vessels, and rendering service in various ways. In the majority of cases they succeed in saving the vessels and cargoes without any other aid than that of the ships' crews, and often alone.

That the crew may become skilled in the handling of the life-lines and breeches-buoys, a constant system of practice is maintained at the stations. For this purpose a pole is set up in the shallow water near the shore, say 75 yards from the place of practice. This pole represents the mast of a wrecked vessel. The crew are called upon in the boathouse, by number, first, and are examined orally. They have to recite the details of the exercise as set down in the service-manual. At the words of command they then fall into place at the drag-rope, and draw the apparatus to the drilling-ground. A man has been placed upon the pole. At the word "action" the crew proceed to rig the apparatus and bring their comrade down from the pole in the breeches-buoy. The time required is noted and recorded. If in one month after the active season has commenced the work cannot be done in five minutes, the men are cautioned. Further admonition is rarely necessary. In fact, an active rivalry exists between many of the stations to perform this mimic rescue in the shortest time. It has been effected in two and a half minutes. This was in the day-

time. At night-drills it has been done in three minutes.

In addition to the wrecking-drill the crew are exercised every week in boat-practice, including launching and landing through the surf, with at least half an hour's rowing; they are also practiced in signaling with miniature flags, accompanied by oral examinations in the main features of the international code of signals, and they are drilled regularly in the manipulation of persons apparently drowned, one of the surfmen serving as the subject to be resuscitated. When this ceaseless round of practice-work is superimposed upon the regular patrol and other duties, it will be understood that the time and muscles of the surfmen are fully engaged. On the monthly visits of the inspectors the latter mark in their drill-books the proficiency of each member of the station force, and report it to the general superintendent, who keeps the record of the rating of every man in the life-saving service.

Upon the sea and lake coasts of the United States there were on June 30, 1895, 251 government life-saving stations. Of these, 184 are on the Atlantic shores, 13 on the Pacific, and 53 on the Great Lakes. One river station is at Louisville, Kentucky, on the falls of the Ohio River.

The life-saving districts are classified by districts, each district including a number of stations situated along a certain coast. The districts, with the extent of coast-line which they include, are the following:

First District—Coasts of Maine and New Hampshire.

Second District—Coast of Massachusetts.

Third District—Coasts of Rhode Island and Long Island.

Fourth District—Coast of New Jersey.

Fifth District—Coasts of Delaware, Maryland and Virginia,—from Cape Henlopen to Cape Charles.

Sixth District—Coasts of Virginia and North Carolina,—from Cape Henry to Cape Fear.

Seventh District—Coasts of South Carolina, Georgia and eastern Florida.

Eighth District—Gulf Coast of United States.

Ninth District—Lakes Erie and Ontario.

Tenth District—Lakes Huron and Superior

Eleventh District—Lake Michigan.

Twelfth District—Pacific coast.

The distribution of stations is regulated by the nature of the coast and the amount of commerce passing by or approaching it. From the eastern extremity of the coast of Maine to Cape Cod there are but 16 stations for 415 miles. The coast, for a great part rocky and precipitous, gives numerous harbors of refuge. Along Cape Cod a dangerous region appears, where there are ten stations, about eight miles distant from each other. The bight formed by the shores of Long Island and New Jersey, with New York harbor at the apex, is renowned for its dangerous nature. Along 250 miles of the shores of this much-frequented waterway there are 79 stations, giving an average distance of about three miles from station to station.

Farther south there is less commerce, and fewer stations are provided. For 175 miles from Cape Hatteras south to Cape Fear there are but six stations, the distance between stations averaging nearly thirty miles. The coast of Florida is of such formation that vessels are generally wrecked close to shore and the crew can save themselves. Refuge-stations for the supply of food and water are provided along the uninhabited portions of this coast. Their average distance apart is 26 miles. At each mile along the coast a guide-post is erected, giving the distance and direction to the nearest refuge-station. Each has provisions enough for twenty-five persons for ten days.

The Great Lakes have a coast of 2,500 miles' extent. Most of the harbors of refuge are artificial, defined by piers and maintained by dredging. These are the scenes of most of the wrecks, as vessels in storms make for the nearest of them, and are liable to strand upon the shoals at their mouths. Forty-five stations protect this great extent of coast, being generally placed at or near harbors.

All these stations are fully supplied with life-boats, wreck-guns, beach-apparatus and restoratives. The stations on the Atlantic coast from the eastern extremity of the state of Maine to Cape Fear, North Carolina, are manned by crews of experienced surfmen from September 1st until May 1st; upon the lake coasts the stations are manned from the opening until the close of navigation; and on the Pacific coast they are manned all the year round. Exceptions are made at the station on Beaver Island, Lake Michigan, and at the stations on Neah Bay and Cape Arago, in Washington. These three stations depend on the volunteer efforts from the neighboring people in case of shipwreck. Neither are the houses of refuge manned by crews. Such houses are located exclusively upon the Florida coast. A keeper, who is supplied with boats, provisions and restoratives, resides in each of them throughout the year. He is required to make extended excursions along the coast after every storm and find out if any shipwreck has occurred. (See DROWNING, Vol. VII, pp. 475, 476.)

The following is a general summary of disasters which have occurred within the scope of live-saving operations from Nov. 1, 1871 (date of introduction of present system), to close of fiscal year ending June 30, 1895:

Total number of disasters.....	8,302
Total value of property involved.....	\$133,641,974
Total value of property saved.....	\$102,342,047
Total number of persons involved.....	67,258
Total number of lives lost.....	750
Total number of persons succored.....	12,013
Total number of days' succor afforded.....	31,353

The cost of maintaining the service during the year ending June 30, 1895, was \$1,345,324.

It is a notable feature of the United States life-saving service that it has always been free from any connection with politics. This feature has been secured by direct provision of law. It is undoubtedly one of the main factors of the remarkable success of the service. The keepers and crews of the stations are chosen solely for

their fitness and capability, and are retained in the service so long as they remain efficient, no matter what their political status may be.

The life-saving crews are forbidden to solicit any rewards for services, but on account of the meagerness of their wages and the great risks of their calling, they are not forbidden to accept rewards if the owners or masters of wrecked vessels, or other persons, see fit, voluntarily, to bestow rewards upon them.

**LIGHTFOOT, JOSEPH BARBER**, an English bishop, was born in Liverpool in 1828; graduated at Trinity College, Cambridge, in 1851; fellow of and tutor in his college, 1852-61; took orders in the Church of England, 1854; Hulsean professor of divinity at the University, 1861; Lady Margaret professor of divinity in the same institution, 1875; canon of St. Paul's Cathedral, London, 1871; select preacher at Oxford, 1874-75; made bishop of Durham, 1879; died at Bournemouth, Dec. 21, 1889. Dr. Lightfoot was one of the best critical scholars of the New Testament. The grammatical analysis and textual notes of his commentaries on *Galatians* (1865); *Philippians* (1868); and on *Colossians* and *Philemon* (1875), placed him in the front rank of modern exegetical scholars. He was one of the English committee on the revision of the *New Testament*. His reply to the anonymous *Supernatural Religion* was issued in 1875 in the *Contemporary Review*, and was published again in 1890. He began an exhaustive treatment of the Apostolic Fathers, but his work went no further than the epistles of *Clement* (1869, new ed., 1890) and of *Ignatius* and *Polycarp* (1885-89).

**LIGHT AND AIR, RIGHTS TO.** See **PRESCRIPTION**, Vol. XIX, p. 706.

**LIGHTHOUSE BOARD, THE**, was created by act of Congress approved Aug. 31, 1852. This act requires the President to appoint two officers of the navy, two officers of the corps of engineers of the army and two civilians of high scientific attainments, together with an officer of the navy and an officer of engineers of the army as secretaries, who shall constitute the United States Lighthouse Board, the Secretary of the Treasury to be *ex officio* president of the board. The Lighthouse Board is attached to the office of the Secretary of the Treasury, and, under his superintendence, attends to the administration of all matters relating to the construction, care, and maintenance of the United States lighthouses, lightships, buoys, and all other aids to navigation. The board meets on the first Monday in March, June, September and December. In addition to these, meetings are called about once every two weeks. The board divides its duties, among standing committees on engineering, on floating aids to navigation, on lighting, on tests and experiments, and on locations. The last-named committee has charge of matters relative to the location of lighthouses, buoys and other aids to navigation.

The Lighthouse Board was required by law to divide the Atlantic, Gulf, Pacific and Lake coasts into lighthouse districts, not to exceed twelve in number. To each district was assigned an officer of the army or navy as inspector; and the President

was required to detail from the engineer corps of the army such officers as might be required to superintend the construction and renovation of lighthouses therein. In 1874 two more districts were placed under the jurisdiction of the board, including the Ohio, Missouri and Mississippi rivers.

At the close of the fiscal year 1895, there were under the control of the Lighthouse Board the following aids to navigation: Lighthouses and lighted beacons, including post-lights in third, fourth, fifth, sixth, eighth and thirteenth districts, 1,396; lightships in position, 41; lightships for relief, 4; electric and gas buoys in position, 23; fog-signals operated by steam or hot air, 130; fog-signals operated by clock-work, 185; post-lights on the Western rivers, 1,411; day or unlighted beacons, 424; whistling-buoys in position, 66; bell-buoys in position, 96; other buoys in position, including pile-buoys and stakes in fifth district and buoys in Alaskan waters, 4,547.

Lighthouses are graded in different orders, according to the sizes of the lenses, the first order being the most powerful. The Lighthouse Board experimented with various illuminants, such as sperm, lard, colza and mineral oils, and finally decided that mineral oil is the best and cheapest, and consequently it is used almost entirely. The consumption of mineral oil is about twice as great as that of lard-oil, but its cost is about one-quarter of the latter. The following table shows the candle-powers of the lamps used in the different orders of lights:

First order	-----5 wicks	-----450 candle-power.
Second order	-----3 wicks	-----163 candle-power.
Third order	-----2 wicks	-----78 candle-power.
Fourth order	-----1 wick	-----32 candle-power.
Fifth order	-----1 wick	-----18 candle-power.
Sixth order	-----1 flat wick	-----125 candle-power.

The above-mentioned 1,411 post-lights are located on the banks of the Mississippi, Ohio, Missouri, Savannah, Cape Fear and Hudson rivers, and at the mouth of the Red River, Louisiana. They consist of a high post set in the ground, properly braced, and supporting a box at the top, in which is placed an ordinary kerosene lantern, and they are located so as to indicate the channel. They can easily be shifted to correspond to the changes in the channel.

In the construction, care and maintenance of the various aids to navigation there were employed during the year 1895. Steam-tenders, 32; steam-launches, 4; sailing-tenders, 2; light-keepers, 1,203; other employees, including crews of lightships and tenders, 1,078; laborers in charge of river lights, 1,364. See also **LIGHTHOUSE**, Vol. XIV, pp. 615 et seq.

**LIGHTNING-ARRESTER**, a device for the protection of electrical apparatus, such as dynamos, telephones, etc., having outside wires, from injury by lightning. During the time of electrical disturbances such machines afford convenient paths to the earth for electricity, and are liable to injury by the passage of too strong currents through them. The principle of the arrester lies in the fact that the electrical machines in question usually have connected with them numbers of coils of wire, through which the discharge must pass to reach the ground. Another



conductor offering less resistance than these coils is therefore placed near the wire leading to the telephone or dynamo, but not touching it. The intervening air-space possesses resistance enough to the steady, relatively weak current which is intended to pass through the machine to insulate it from the second conductor or arrester, but for varying currents of great intensity, such as electrical discharges in the atmosphere, the air-space offers less resistance than the coils of wire in the machine. The great difficulty in the construction of such arresters is that the air between the machine and the arrester when heated loses, to a certain extent, its resistance, and hence conducts off, also, the current intended to remain in the circuit of the machine. Several devices have been invented to prevent this, the most successful of which is to make the air-space a strong magnetic field, which causes the arc to be diverted at right angles to the lines of force, and destroyed.

**LIGNIN.** See **PHYSIOLOGY**, Vol. XIX, p. 44.

**LIGNITE** (called also "wood-coal" and "brown-coal"), a mineral coal retaining the texture of the wood from which it was formed. See also **COAL**, Vol. VI, p. 46.

**LIGONIER**, a town of Noble County, north-eastern Indiana, situated on the Elkhart River, and on the Lake Shore and Michigan Southern railroad, 35 miles N.W. of Fort Wayne. It manufactures carriages, tubs and barrels, and has flour and lumber mills. Population 1900, 2,231.

**LIGOR.** See **MALAY PENINSULA**, Vol. XV, pp. 322, 323.

**LI HUNG CHANG**, a viceroy of China, and the highest ranking officer in the empire, was born in the village of Hwei-Ling, in the province of Nganhwei, in 1822. He took the Hanlin degree in 1849. When the Taiping rebels invaded Nganhwei in 1850, he joined the army as secretary. He was appointed provincial judge of Chêhkiang province, and in 1861 governor of Kiangsu. In conjunction with General Gordon he recovered Su-



LI HUNG CHANG.

chau in 1863, and drove the rebels entirely out of Kiangsu. For his services he received the yellow jacket and peacock's feather, and was created an hereditary noble of the third class. Two years later he was appointed governor-general of the Liang-Kiang provinces, and subsequently commanded against the Nienfei and Mohammedan rebels. In 1872 he was appointed governor-general, or viceroy, of Chili, the metropolitan province. His advancement was due to his own achievements, his practical ability elevating him to his high rank. He was frequently, but improperly, styled viceroy of China, whereas his jurisdiction was confined to the province of Chili. He always proved himself to be a friend to foreigners and to European culture and industry. A member of the Board of Admiralty, he originated the Chinese navy; and he was

the chief promoter of the China Merchants' Steam Navigation Company, the only native steamship line. He has practically controlled the foreign policy of the empire, and every department of imperial administration, with consummate forethought and address. In 1894 the Emperor of China appointed him commander-in-chief of the Chinese forces, both naval and military, which were engaged in the war with Japan, but early in the war marked his displeasure by depriving him of the yellow jacket and the peacock's feather, and later superseded him in the chief command. Later, however, he was reinstated in his former offices as the result of his negotiations for peace with Japan. In 1896 he made a tour through Europe and America. On his return to China Earl Li, as this enlightened statesman is sometimes called, was made foreign secretary of the empire; but in 1898 he was temporarily disgraced and excluded from the Tsung-li-Yamên. He was afterwards reinstated by the Empress-Dowager and given a commissionership in Southern China. When the Boxer rising broke out, in the summer of 1900, Earl Li came to the front as intermediary between the Chinese Court and the foreign Powers in possession of Peking. He is at present engaged in this delicate bit of diplomacy.

**LILIUOKALANI**, **LYDIA KAMAHEHA**, ex-Queen of Hawaii; born Dec. 2, 1838. She was the eldest sister of King Kalakaua, and when he left the islands for a visit to the United States she became regent. After his death in San Francisco she was proclaimed queen, Jan. 29, 1891. She had attempted to abolish the constitution of 1887, and to reign as an absolute monarch, and thereby aroused the opposition of the liberal party in the kingdom, which consisted largely of white immigrants from the United States. A committee of public safety was formed by the latter, who proclaimed her deposed and the monarchy abolished, Jan. 17, 1893. In Jan., 1895, an insurrection occurred, with the purpose of reinstating her, but the movement was quelled, and the ex-Queen was arrested. She afterward resigned all pretensions to the throne, and took the oath of allegiance to the republic, and in Feb., 1896, was pardoned. She was married to John O. Dominis, an American from Boston, who died in 1891.

**LILLY**, **WILLIAM SAMUEL**, an English writer, born at Fifehead, Dorsetshire, in 1840, and educated at St. Peter's College, Cambridge, graduating senior scholar and classical prizeman. He entered the Indian civil service by open competition; was under-secretary to government in 1869; and was called to the English bar in 1873. He published *Ancient Religion and Modern Thought* (1884); *Chapters in European History* (1886); *A Century of Revolution* (1889); and *Claims of Christianity* (1894).

**LILVÆUM** or **LILYBÆION**. See **MARSALA**, Vol. XV, p. 571.

**LILY OF THE VALLEY**, a name given to *Convallaria*, a genus of plants of the family *Liliaceæ*, having terminal racemes of flowers; a white, bell-shaped or tubular six-cleft or six-toothed perianth; a three-celled ovary, with two ovules in each cell, and a succulent fruit. The species commonly known as the lily of the valley (*C. majalis*), the

*Maiblume*, or Mayflower, of the Germans grows in bushy places and woods in Europe, the north of Asia and North America, and has a leafless scape, with a raceme of small flowers turned to one side.

LIMA, a post village of Livingston County, western New York, on Honeoye Creek, 4 miles S. of Honeoye Falls, on the Lehigh Valley and the Lima and Honeoye Falls railroad. It is the seat of Genesee Wesleyan Seminary. Population 1890, 1,003.

LIMA, a city and the capital of Allen County, northwestern Ohio, on the Pittsburg, Fort Wayne and Chicago, the Cincinnati, Hamilton and Dayton, the Lake Erie and Western and the Ohio Southern railroads. In 1885 petroleum was discovered here, and since then the city has grown rapidly and become one of largest shipping-points for this product in the country. Mining and edged tools are manufactured extensively. Population 1900, 21,733. See also LIMA, Vol. XIV, p. 645.

LIMACIDÆ. See MOLLUSCA, Vol. XV, p. 660.

LIMASSOL, a seaport. See CYPRUS, Vol. VI, p. 748.

LIME. See LIME, Vol. XIV, p. 648 and LINDEN, in these Supplements.

LIME-BALL LIGHT. See DRUMMOND LIGHT, in these Supplements.

LIME-LIGHT OR OXYCALCIUM LIGHT. See MAGIC LANTERN, Vol. XV, p. 212.

LIMESTONE. See GEOLOGY, Vol. X, pp. 232, 238, 239.

LIMICOLÆ, a group of birds, including the plovers, snipes and their allies. They are all small wading birds. See also ORNITHOLOGY, Vol. XVIII, p. 45.

LIMICOLÆ, a group of annelid worms, including the aquatic oligochætes. The opposite term *Tenicolæ* is applied to the group of terrestrial forms. The *Limicolæ* are numerous in species and in individuals. The naiads are probably the best-known representatives. See also WORM, Vol. XXIV, p. 677.

LIMITATION OF ACTIONS. These statutes, as they exist in the various states of America, resemble, in many respects, the statutes in force in England. They may be said generally to begin to run from the time the cause of action accrues. When money is payable in installments the limitation usually begins to run from the time the last installment becomes due. There are many circumstances, however, which will operate to take a case out of the statute of limitations.

In the following column the periods of limitation fixed by statutes in the various states are tabulated for ready reference purposes. It may be stated, as a general proposition of law, that the statutes never run against an express trustee, and that in many cases provision is made for an extension of the period of limitation in cases where the statute runs against the interests of the state, minors, married women, lunatics, or persons abroad. It would be impossible to express such exceptions in tabular form, and would trench upon the province of a legal text-book. In every case reference should be made to the precise words of the statute, and the advice of an experienced attorney taken.

## LIMITATION OF ACTIONS.

STATE.	REAL ACTIONS.		NOTES AND WRITTEN CONTRACTS.	JUDGMENTS IN THE STATE.		JUDGMENTS OF OTHER STATES.
	Years.	Years.		Years.	Years.	
Alabama	10	3	6	20	20	
Arizona	5	3	5	5	2	
Arkansas	5	3	5	10	10	
California	5	2	4	5	5	
Colorado	5	6	6	10	6	
Connecticut	15	6	6	--	--	
Delaware	20	3	6	20	20	
District of Columbia	20	3	3	12	12	
Florida	7	4	5	20	7	
Georgia	7	4	6	10	5	
Idaho	5	4	5	6	6	
Illinois	20	5	10	20	5	
Indiana	20	6	10	20	20	
Indian Territory	--	3	5	10	10	
Iowa	10	5	10	20	20	
Kansas	15	3	5	5	5	
Kentucky	15	5	5	15	15	
Louisiana	10	3	5	10	10	
Maine	20	6	6	20	6	
Maryland	20	3	3	12	12	
Massachusetts	20	6	6	20	20	
Michigan	15	6	6	10	10	
Minnesota	15	6	6	10	10	
Mississippi	10	3	6	7	3	
Missouri	10	5	10	10	10	
Montana	10	3	8	10	10	
Nebraska	10	4	5	5	5	
Nevada	6	4	6	6	6	
New Hampshire	20	6	6	20	20	
New Jersey	20	6	6	20	20	
New Mexico	10	4	6	7	7	
New York	20	6	6	20	20	
North Carolina	7	3	3	10	10	
North Dakota	20	6	6	10	10	
Ohio	21	6	15	21	21	
Oklahoma	--	3	5	6	1	
Oregon	10	6	6	10	10	
Pennsylvania	21	6	6	20	20	
Rhode Island	--	6	6	20	20	
South Carolina	10	6	6	20	20	
South Dakota	20	6	6	20	10	
Tennessee	7	6	6	10	10	
Texas	10	2	4	10	10	
Utah	7	2	4	5	5	
Vermont	15	6	6	8	8	
Virginia	15	2	5	20	--	
Washington	10	3	6	6	6	
West Virginia	10	5	10	20	10	
Wisconsin	10	6	6	20	10	
Wyoming	10	8	5	5	2	

See also LIMITATION, STATUTES OF, Vol. XIV, pp. 650, 651.

LIMONITE. See MINERALOGY, Vol. XVI, p. 388.

LIMPET. See MOLLUSCA, Vol. XVI, pp. 645-648.

LIMPKIN OR COURLAN, the common names of the rail-like birds of the family ARAMIDÆ; q.v., in these Supplements.

LIMPOPO RIVER. See AFRICA, Vol. I, p. 254; TRANSVAAL, Vol. XXIII, p. 517.

LIMULUS. See CRUSTACEÆ, Vol. VI, pp. 653-662.

LINCOLN, a city and the capital of Logan County, central Illinois, 28 miles N.E. of Springfield, a flourishing manufacturing city, on the Peoria, Decatur and Evansville, the Chicago and Alton and the Illinois Central railroads. It is also the center of a rich agricultural district, with a good

coal-supply, and makes extensive shipments of grain and other produce. Its manufactures include flour, canned goods, excelsior, horse-collars, press-drills, bricks and tiles, and machinery. It has a public library and an electric street-railway. Lincoln University, founded in 1865, is situated here, with 160 students in 1896 and a library of 3,000 volumes. It is the location of the Odd Fellows' Orphans' Home of Illinois; and the State Asylum for Feeble-Minded Children. Population 1890, 6,725; 1900, 8,962.

LINCOLN, a city and the capital of Lincoln County, central Kansas, 32 miles W.N.W. of Salina, on the Saline River, and on the Union Pacific railroad. It is in a corn, wheat and wool growing region, produces marble, coal and building-stone, and has good water-power. It is the seat of the Kansas Christian College. Population 1900, 1,262.

LINCOLN, a city of southeastern Nebraska, and the state capital. It is on the Burlington and Missouri River, the Chicago, Rock Island and Pacific, the Fremont, Elkhorn and Missouri Valley, the Missouri Pacific and the Union Pacific railroads. It is characterized by its great commercial activity, being a great distributing-point for the whole southern part of Nebraska and a great deal of Kansas, of all kinds of merchandise and lumber, coal, grain and livestock. It has large stockyards and slaughtering and meat-packing houses. In manufacturing, the city is not so advanced as in commerce. Bricks, tiles, pottery, carriages and machinery are the principal products. It has several educational institutions, among them the University of Nebraska, Nebraska Wesleyan University, Cotner University, Union College, Nebraska Military Academy and normal and musical schools. Pop. 1890, 55,154; 1900, 40,169. See also LINCOLN, Vol. XIV, p. 658.

LINCOLN, BENJAMIN, an American general; born at Hingham, Massachusetts, Feb. 3, 1733. At the outbreak of the Revolution he was active in organizing the Massachusetts troops; in 1776 was appointed major-general of the state militia; commanded the expedition that, in 1776, cleared Boston harbor of British vessels. Having reinforced Washington after the defeat on Long Island, he was given an appointment as major-general in the Continental army. Lincoln served with Schuyler against Burgoyne during the next summer, and afterward was wounded at Bemis Heights, while reconnoitering. In August, 1778, he was placed in command of the army in the South. In 1780 he was besieged at Charleston by Sir Henry Clinton with a superior force, had to capitulate, and returned to Hingham on parole. But after being exchanged in 1781 he joined Washington again on the Hudson, was with him at the siege of Yorktown, and was deputed by Washington to receive the sword of Lord Cornwallis on his surrender of the British forces. From 1781 to 1784 Lincoln was Secretary of War. After quelling Shay's rebellion in Massachusetts in 1787, he was elected lieutenant-governor, and in 1789 Washington appointed him collector of the port of Boston, which office he held till 1808, when he retired from public life. He died in Hingham, May 9, 1810. His *Life* was written by Francis Bowen in Sparks's *American Biography*.

LINCOLN, ROBERT TODD, an American public man, eldest son of Abraham Lincoln; born at Springfield, Illinois, Aug. 1, 1843, and was educated at Phillips Exeter Academy and at Harvard. During the latter years of the Civil War he served as a captain on the staff of General Grant. After the war he practiced law in Chicago until 1881, when he became Secretary of War in Garfield's Cabinet. This office he retained until the close of President Arthur's administration, when he returned to his law practice in Chicago. In 1889 President Harrison appointed him minister to England, which position he resigned on the accession of President Cleveland in March, 1893.



ROBERT T. LINCOLN.

LIND, JENNY. See GOLDSCHMIDT, MADAME JENNY MARIA LIND, in these Supplements.

LINDAU, PAUL, a German dramatic author and critic; born June 3, 1839, at Madgeburg, Prussia. He studied philosophy and literature at Halle, Leipsic, Berlin and Paris; returned to Germany, and afterward edited *Die Gegenwart* and *Nord und Süd*, both of which he founded. Among the earliest fruits of his literary talents were the books of travel *Aus Venedig* (1864) and *Aus Paris* (1865); and later, *Aus der Neuen Welt* (1884), the last being a journal of American travel, including a visit to the Northwest, where he witnessed the opening of the Northern Pacific railway. His skill as a writer of critical sketches in a satirical and humorous manner is shown in *Harmlose Briefe Eines Deutschen Kleinstädters* (1870) and *Literarische Rücksichtslosigkeiten* (1871); and his caliber as a literary critic in studies on *Molière* (1871) and *Alfred de Musset* (1877), and in *Dramaturgische Blätter* (1875-78), *Nüchterne Briefe aus Baireuth* (1876), *Baireuther Briefe* (1883), and *Aufsätze* (1875). But he is, perhaps, better known as a writer of plays and novels, the subjects of which are taken almost exclusively from modern life. The former possess the merits of lively dialogue and a fair degree of dramatic power; the most successful was perhaps *Maria und Magdalena*. A collection of his theatrical pieces was published in three volumes as *Theater* (1873-81). The novels include *Herr und Frau Bower* (1882); *Toggenburg* (1883); *Mayo* (1884); *Berlin* (1886-87); and *Im Fieber* (1889).

LINDEN OR LIME. The American linden (*Tilia Americana*) is a well-known timber tree, often planted along alleys for shade. It furnishes "bast," or bast-bark, equal to its European namesake. This bast is here sold for tying bundles of kindling-wood and various other binding purposes, especially in nurseries. Dried linden flowers are often used for making tea, which is taken as a sedative. See also LIME, Vol. XIV, p. 648.

LINDLEY, SIR NATHANIEL, an English jurist, the son of Dr. John Lindley, botanist and author; born at Acton Green, Middlesex, in 1828, and educated at University College, London. He was called

to the bar at the Middle Temple in 1850, and practiced in the Court of Chancery. He was appointed a queen's counsel in 1872, and in 1875 was appointed a judge of the Court of Common Pleas, receiving, at the same time, the honor of knighthood. In November, 1881, he was chosen one of the lords justices of the Court of Appeal, and soon afterward was sworn of the Privy Council. Lord Justice Lindley is known to the English-speaking world as the author of a masterly *Treatise on the Law of Partnership and Companies* (6th ed. 1893), which is the standard text-book on this branch of law. He also wrote an *Introduction to the Study of Jurisprudence*.

LINDSAY, a town of Victoria County, Ontario, Canada, on two branches of the Grand Trunk railroad, 80 miles N.E. of Toronto. It has a large trade in grain, lumber and flour, and manufactures iron, machinery, leather, flour and wooden articles. It is the trade center of a farming and lumbering region. Population 1891, 6,081.

LINDSBORG, a village of McPherson County, central Kansas, 18 miles S. of Salina, on the Smoky Hill River, and on the Union Pacific and Missouri Pacific railroads. It is an agricultural center, and has manufactories of brooms, machinery, castings, and flour and saw mills. It was settled by Swedes, and Bethany College, a Swedish institution, is located here. Population 1900, 1,279.

LING, PETER HENRIK, a Swedish poet and gymnast; born at Ljunga, Smaland, Nov. 15, 1776. After studying theology, he wandered through Germany and France, leading an adventurous life. In 1805 he became fencing-master in the University of Lund, and in 1813 at the military school at Carlsberg, and in 1814 was appointed director of the gymnastic institute in Stockholm. His main endeavor was to adapt his gymnastics to the needs of the various parts of the body instead of to the arms only. At first his exercises were confined to the muscular development of the body, but later made use of his system for the cure of certain chronic diseases, the treatment becoming known as the Swedish movement cure. His success led to his being made a member of the Swedish Academy and the receipt of various honors from the king. His main poetical works are the *Gylfe* (1812) and *Asarne* (1816-26). His *Elementary Principles of Gymnastics* and other works on the movement cure were published after his death. As a poet he belonged to a group of men of letters who endeavored to re-awaken the spirit of ancient pagan heroism by turning the thoughts of their countrymen to the early history and mythology of their Swedish ancestors. He died in Stockholm, May 3, 1839.

LINGUATULIDÆ, a family of animals, believed to be degenerated arachnids. The adults are elongated, worm-like animals, living in the lungs and nasal cavities of various animals. No appendages are present, except a pair of hooks at the anterior end. One species (*Pentastomum Tenioides*) lives in the nasal sinuses of the dog and wolf. The ova pass to the exterior with mucous discharges, develop into mite-like forms, which, if taken into the alimentary canal of a rabbit, bore through into the liver and become encysted. Later, these larvæ

migrate to other tissues. If infected tissues be eaten by a dog the larvæ attaches to the membrane of the mouth and passes into the nasal chambers, where the adult form is assumed. The family is also called *Pentastomide*.

LINGULIDÆ. See BRACHIOPODA, Vol. IV, p. 194.

LINNÆA, a genus of plants of the family *Caprifoliaceæ*, or honeysuckles. It contains but a single species, *L. borealis*, the twin-flower found in the more northern regions of Europe, Asia and North America. It is a small trailing evergreen herb, characterized by lanceolate calyx-lobes and bell-shaped flowers occurring in pairs.

LINO TYPE, the name of a machine that produces words in stereotyped lines, or bars, from matrices of type automatically set. The earliest type-setting machine on record is described in Herhan's specification in the British Patent-Office, under date of 1794.

Church of Connecticut improved upon it by suggesting the keyboard principle in 1822. The casting system was pursued, and was intended to supersede the manipulation of separate types. Movable matrices were cast in single lines. His attempt was designated as the "guide-plate" principle. He put the types in channels, and operated them with keys arranged like the keys of a harpsichord.

Variations, modifications and improvements began to follow rapidly, beginning with about 1840, when Delacambre and Young took out the first of a rapid series of patents. Clay and Rosenberg, also in 1840; Joseph Mazzini, in 1843; William Martin, in 1849; Mitchel, Boule and Carland, in 1853; Simoncourt and Wiborg, in 1854; Coulon, in 1855; Delacambre and Alden, in 1856; and Robert Hattersley, in 1857,—all followed with their different ideas of improvement. The Alden (England, 1856, and United States, 1857) was in practical use for many years in New York, on book-work. Its capacity was rated at three thousand five hundred ems an hour. Type of ordinary manufacture was used, but each character had a nick peculiar to itself. The machine was about the size of an ordinary table, the upper part describing the outline of the letter D. The operator sat at one end of the flat side. The curved portion contained a horizontal wheel, holding the type in cells. By the rotation of the wheels several receivers were also made to rotate, and these picked up the proper types from their respective cells.

It was reserved for Hattersley to produce the first machine to remain in practical use for any length of time.

To the main frame he fastened a type-table, containing a metal case in which the types could move freely. "Followers" were arranged in the rear, that pressed the type against a fixed plate by means of a vulcanized india-rubber spring. The last type of a row was depressed by a piston into a guide-plate provided with grooves converging to a single outlet below. As the composition proceeded, a lever pushed the stick forward. The types were placed in the composing-stick direct by only one motion. Distribution was accomplished

by placing the types in an inclined galley, the line lowest in the column resting on a sliding bar, having within it a series of metal pieces, the ends of which projected, so that when the bar was moved, they pushed against the lower line of type in the galley, thus sliding it into the groove, each piece working upon a separate line. The matter was read as it approached a given point; the operator touched a key on the board before him, and the letter which answered to the key was instantly conveyed to its proper receptacle.

Beginning with the year 1822, there were, in England, thirty-five patents granted on type-setting machines up to the year 1872; and beginning with 1840, and ending at the same time (1872), the United States granted thirty-five patents. Since that time the advance is counted by the hundreds.

Those attracting the greatest amount of public attention are, at the present time, the Frasier, described in Vol. XXIII, p. 701; the Thorne, the Mc-Millan, the Mergenthaler and the Rogers. For the Thorne and Rogers, and more recent patents, see TYPE-SETTING MACHINES, in these Supplements.

The most difficult of all the problems to be conquered in type-setting mechanisms is the automatic

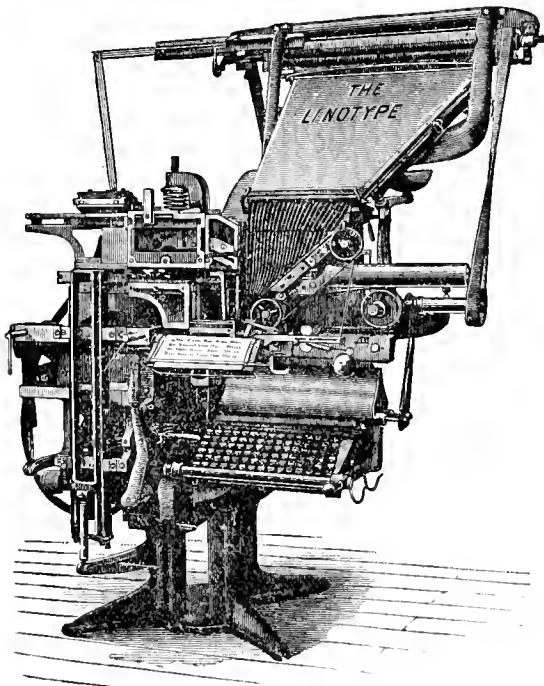

THE MERGENTHALER LINOTYPE.

justification of the lines—that is, equal spacing of the words constituting the line of printed characters. The difficulty about justification arises from the fact that the size of the spaces required is not known until the line is set. The hand-compositor goes back over his line and changes the spaces as may be necessary to justify. There is no easy way to imitate this by machinery.

To Otto Mergenthaler of Baltimore belongs the credit of utilizing many brilliant thoughts of inventors in this field. He conceived the idea of setting up a line of matrices, and using expansible

spaces operated automatically. After the line of matrices is set up and spaced so as to justify, he casts against this mold a solidified line of type (a linotype) containing the same characters as the matrices set up. Freed from the restrictions imposed when using type, he can make the matrices of whatever size and material the purpose requires.

The matrices in the linotype are made of brass. In shape they are a parallelogram, an inch and a quarter long by three quarters of an inch wide. The thickness of the matrix corresponds with the width of the letter, thick for an "m," thin for an "i" or an "l."

The character is stamped on the side edge of the matrix, the depth corresponding to the shoulder on the type, and is about one third the distance from the bottom of the matrix. These matrices are stored in what may be likened to a toboggan-slide, composed of two parallel plates separated by five eighths of an inch and containing grooves in their opposing faces. The matrices lie with their side edges engaged in the grooves. Each set of grooves contains the matrices for only one character. At the lower end of each set is an anchor escapement, connected indirectly to a key on the keyboard. When a key is depressed it operates the escapement so as to allow the bottom matrix to escape by force of gravity from the grooves, and fall to a traveling-belt which urges it to the left, toward the assembling-point. The other matrices in the groove slide down the distance of one matrix.

The spacing devices, which are made of steel, are about four inches long by nine-sixteenths of an inch wide. They are in two parts, fitted by a dovetailing process, a long piece sliding on a short piece. They form double wedges, the outer faces being parallel. The spacing is effected by releasing, one by one, at the end of each word, a wedge-shaped bar, which are stored in a separate magazine, from which they are discharged into the receiver in a manner similar to that in which the matrices are fed.

It is this peculiar spacing feature that has been heretofore regarded as one of the impossibilities in the construction of a machine that could take the place of hand-justifying, but the simplicity of the wedge, the ease with which it falls into place, and the certainty of a correct spacing, has been so thoroughly accomplished, that the wonder is that it had not been thought of before. The wedges are about three inches in length, and, while the thin part only is first inserted by the space-key at the proper places, the whole series will be, by the touching of another key, driven to just the right pressure for the complete and even justification of the line. The possibility of such a procedure first came to Merrit Galley, of New York, who built a machine and secured the necessary letters patent in 1872. His space-wedge was first a pair of plain wedges playing on each other; then, to give a better alignment, a shouldering feature was introduced, whereby a perfect pressure between the type or matrices was secured, and the justification made perfect.

In the original machine electrical connections were made, so that what was done on one machine could be repeated on as many machines as were

put in connection with the original worker. Thus, a machine at Washington, with one operator, could report proceedings in New York, Boston, Philadelphia, Chicago, San Francisco, etc., and cast the lines of type, all under the manipulation of the single operator in Washington. Mr. Mergenthaler caught at the idea and succeeded in making it practical.

For correction of a mistake, or for any other reason, the operator can, by hand, transpose or change any matrix in the line.

By a movement of the hand-lever, the completed line is started over to the casting-mechanism. A pair of rails fastened to a vertically sliding frame carries the line of matrices down between two metal jaws projecting from a plane face of iron. These jaws close to the exact pressure or length of line. A cross-bar below rises and strikes the bottoms of all the long sliding pieces of the justifying spaces, forcing them, in their wedge form, farther into the line, and so widening all the spaces until the line fills the distance between the jaws. Thus is accomplished the act of justification.

The mold is made of hardened steel, and is the segment of a cast-iron disk 14 inches in diameter, capable of rotation, and carried on a frame that slides in the direction of the axis. This mold advances and aligns the line by pressing it against the fixed plane surface behind the matrices, the stamped characters just meeting and closing the opening at the front face of the mold. The pot containing the melted type-metal follows behind the mold, and closes the opening at the back face. The hot metal is injected from a row of holes in the pot into the mold, and, when chilled, the pot, mold and line of matrices are separated. The cast linotype is ejected, having passed by and between knives so as to have it machine-finished to exact size, and placed on a galley.

The sliding frame raises the line of the matrices up to the height of the space-box; an arm comes down from above, separates the brass matrices from the spaces, allowing the latter to slide *en masse* into their box, and carries the matrices up to the top, where they are fed by a vibrating arm, into the distributor.

*The Distribution* To explain the distribution it must be said that a large V is cut in the top edge of each matrix. This V is serrated with seven teeth on each side. The distributor-bar is horizontal, of steel, shaped at its bottom edge to correspond to the serrated V of the matrix. The matrices are fed on to this bar and are supported by their engaged teeth. As they hang from this bar, they are slid along by conveyer-screws, and driven through a set of passages leading to the toboggan-slide previously mentioned. These passages are distant one quarter of an inch from center to center. The teeth on the bar are cut away in sections, so that at every quarter of an inch there is a different combination of teeth left full on the bar. Certain of the teeth on the matrices are also cut away, the combination being the same for all of any one character, and different from any other characters. So long as there is on the matrix one pair of full teeth corresponding to a pair of full teeth on the bar, the matrix is sup-

ported, but when it arrives at a point on the bar over its appropriate passage, there are no teeth on the bar, and, there being nothing to support the matrix, it drops into its passage and slides from there into the toboggan-groove. As those in advance of it in the groove are used, it follows down, and finally becomes the bottom matrix once more, and starts over the same circuit again.

There are ninety keys on the key-board. Infrequently used characters are kept on a convenient frame, and can be readily inserted by hand. Blank matrices are used as "quads."

Any size type, from agate to small pica, inclusive, will run in the same grooves, so that any of the included fonts may be used in one machine. The machine can also be changed to any reasonable length.

As soon as one line is completed and started to the caster, the operator proceeds to set up another line. The keys are operated like typewriter-keys. The operator has nothing to do but to manipulate the keys and start the line. The capacity of the machine is from 8,000 to 10,000 ems per hour.

The moment the linotypes leave the machine they are ready to go into the form without any second operation. The spacing in any one line is uniform. After a line is once set up, the casts from it may be repeated as often as desired, at the rate of six a minute. The lines being solid, there is no piling. Leads are inserted at the pleasure of the maker-up of the forms. The old style hand-distribution does not exist, as the linotypes are melted over, when they have served their purpose. The metal is kept hot by Bunsen gas-flames, consuming a total of about fifteen feet of gas per hour. The space occupied by each machine is five by five feet and its weight is about two thousand pounds.

D. O. KELLOGG.

LINTON, ELIZABETH (LYNN), an English essayist and novelist; born at Keswick, Feb. 10, 1822. In 1858 she was married to WILLIAM JAMES LINTON (q.v., *post*, p. 1892). She was an indefatigable worker. Besides her numerous novels she did a great deal of magazine-work, and at one time was a constant contributor to the *Saturday Review*, in which her papers on *The Girl of the Period* attracted much attention. She wrote *Grasp Your Nettle* (1865); *Sowing the Wind* (1867); *Joshua Davidson* (1872); *Patricia Kemball* (1874); *Under Which Lord?* (1879); *The Rebel of the Family* (1880); *Christopher Kirk and* (1885); *Paston Carew* (1886); *Through the Long Night* (1888); and *The One Too Many* (1891). Died in London, July 14, 1898.

LINTON, SIR JAMES DROMGOLE, an English water-color and oil painter, born in London, Dec. 26, 1840. After instruction from Mr. Leigh, he became an illustrator of books and magazines, and at the age of 21, exhibited water-colors at the Dudley Gallery and Royal Academy, of which he was chosen a member in 1867. His water-color *Maudy Thursday* attracted much attention in 1874, and he received for it the gold medal of the Philadelphia International Exhibition. As a painter in oils he also attained success, particularly in historical subjects. In 1884 he was chosen president of the Royal

Institute of Painters in Water-Colors, and in the following year was knighted. Among his best-known pictures in water-colors are *Off Guard*; *Priscilla*; and *The Cardinal Minister*. He worked continually to gain for painting in aquarelle the attention it merits, and in 1863, being dissatisfied with the treatment of water-colors by the Royal Academy, founded, with other artists, the association of which he was afterward president.

LINTON, WILLIAM JAMES, an English-American author, engraver, and painter in water-colors; born in London, Dec. 7, 1812. He illustrated *Jackson's History of Wood-Engraving*, *The Lake Country*, and *Deceased British Artists*. In his youth Linton was an enthusiastic Chartist, a friend of the political refugees who came to England, and a supporter of the republican and revolutionary movements in Europe. In 1851 he was one of the founders of the *London Leader*. In 1858 he married ELIZABETH LYNN (q. v., ante, p. 1891). In 1867 he came to the United States, settling first at New York and afterwards at New Haven. American books and magazines profited by his admirable illustrations, and he greatly improved the art of wood-engraving in this country, of which art he may be said to have founded a school. He published *Claribel, and Other Poems* (1865); *History of Wood-Engraving in America* (1882); *Golden Apples of Hesperus* (1882); *Rare Poems of the Sixteenth and Seventeenth Centuries* (1883); *A Manual of Wood-Engraving* (1884); *The Masters of Wood-Engraving* (1889); and a *Life of Whittier* (1893). He wrote his *Memories* in 1895. Died at New Haven, Conn., Dec. 29, 1897.

LINUM, the genus to which belongs the common flax (*L. usitatissimum*), and the typical genus of the small family *Linacæ*. The flowers are perfectly regular and symmetrical, with the parts in fives, and of various shades, the wild species of North America being yellow, the common flax blue, and certain cultivated ones red.

LIODON, a genus of extinct marine reptiles of the family of *Mososaurians*. Their remains are found in the cretaceous strata of western United States, some specimens being 75 feet long.

LIPPE, a principality of northwestern Germany. Area, 469 English square miles; population 1895, 134,854; capital, Detmold, pop. 1895, 11,237.

The budget is arranged for two years. For 1895-96 the revenue was estimated at \$297,653; for 1896-97, at \$298,579; expenditure about the same. Reigning prince (1899), Alexander, born Jan. 16, 1831, son of Prince Leopold and of Princess Emilie of Schwarzburg-Sondershausen; succeeded to the throne at the death of his brother, March 20, 1895. Regent, Count Ernst of Lippe Biesterfeld, born June 9, 1842. The elder brother, Waldemar, of the present prince, who reigned before him, was born April 18, 1824; succeeded his brother Dec. 10, 1875.

The house of Lippe is the oldest branch of the ancient family of Lippe, formed in the latter part of the sixteenth century. The prince has not a civil list, but the expenses of the court are provided for by revenues from his hereditary domain. See also LIPPE, Vol. XIV, p. 683.

LIPPINCOTT, SARA JANE CLARKE, an American

authoress; born in Pompey, Onondaga County, New York, Sept. 23, 1823. She was educated at Rochester, New York, and in 1843 moved to New Brighton, Pennsylvania. She began her literary career by writing a series of letters, under the pseudonym "Grace Greenwood," to the *New York Mirror*. In 1853 she married Leander K. Lippincott, of Philadelphia. Mrs. Lippincott was a lecturer for the anti-slavery cause, and wrote *Greenwood Leaves* (first and second series, 1849 and 1851); *Haps and Mishaps of a Tour in Europe* (1852); *Bonnie Scotland* (1860); *New Life in New Lands* (1872); *Stories for Home Folks* (1885); and *Stories and Sketches* (1892).

LIQUEFACTION OF GASES. See PNEUMATICS, Vol. XIX, p. 245; HYDROGEN, Vol. XII, pp. 433, 434; and CHEMISTRY, in these Supplements.

LIQUID AIR. Of late, chemists have been interesting themselves over the novelty of liquid air and discussing its industrial applications and probable uses as a therapeutic agent. As a refrigerating medium it is hardly likely to compete with ice; in this and in other forecasts of its uses its adoption is as yet speculative. As a local anæsthetic, it has, however, been very successful, though the fear is that the part anæsthetized may become irretrievably frozen. That it may take the place of steam as a motive power, of gunpowder in the armies and navies of the world, of dynamite in blasting and other engineering work, as well as of ice in refrigerating meats, etc., while in transit to distant markets, are expectations that may or may not be realized. As a freezing agent, there is no denying its terrible power, and the unscientific mind stands appalled to think that air—the simple air we breathe—can become so intensely cold in the process of liquifying that a temperature below zero of 312° can be reached. At this low temperature pure alcohol can be readily frozen, and mercury can be solidified so hard that, as it has been said, it may be used as a hammer to drive nails into hard wood. As an explosive, for blasting purposes, great power is also claimed for liquid air; while it will sear living flesh like a red-hot iron, and may thus take the place of all chemical cauterizing in surgery. In Germany, thanks to the initiative of Herr Carl Linde, liquid air has already passed as a mere product of the laboratory to the practical purposes of commerce. In this country, it has been freely, and to a large extent successfully, exploited by Mr. Charles E. Tripler, of New York, who is understood to be perfecting a machine that will produce liquid air not only for hospital purposes, but for the widest uses of commerce. In this connection we may chronicle the labors of Prof. James Dewar, of London, who for some years past has been engaged on experimental researches at low temperatures and has succeeded in liquifying hydrogen, a feat of great scientific interest as well as of immense future importance.

LIQUOR LAWS IN THE UNITED STATES. Various laws have been passed in the separate states with a view to prohibit, regulate or restrict the sale of intoxicating liquors within the jurisdiction of such states. It would seem that almost

every system which has been tried still appears among the existing laws of some state, even though discontinued elsewhere. The laws through which effort has been made to control the liquor traffic may be classed as prohibition, local option, license, or civil-damage liquor laws.

Prohibition laws generally provide that no person shall be permitted to manufacture, sell, keep for sale, give or otherwise furnish intoxicating liquors within the state, and severe penalties are enacted for violations of the law. Beginning with Maine in 1851, prohibition laws were enacted in nearly every state of the Union north of Pennsylvania and the Ohio River. In 1880 Kansas led the experiment of incorporating into her constitution a provision that — "The manufacture and sale of intoxicating liquors shall be forever prohibited in this state, except for medical, scientific, and mechanical purposes;" and two years later Iowa followed this example, but the courts set the amendment aside for some defect in its enactment. In 1892, prohibition prevailed in Maine, New Hampshire, Vermont, Kansas, and the two Dakotas.

Option laws provide that any specified district in the state may, upon a vote of the people therein, prohibit the sale of liquor within its boundaries. These laws, when put in force by such vote, operate in about the same manner as general prohibitory laws. The manner of the vote and the districts which may take advantage of the law are the chief points of difference. In some states the vote is taken direct upon the question, and in others the officers vote for determining the question.

The districts are variously composed. Some states provide that cities and towns may determine the question for themselves, others provide that a vote may be taken by counties.

License laws are enacted in most states, under which the applicant for license as a liquor-dealer must pay a certain sum named in the statute or determined upon by the city or village authorities, and must comply with certain requirements as to character, citizenship, etc. Frequently he is required to give a bond conditioned that he will observe the laws concerning the sale of liquor. These license fees range from forty dollars to one thousand dollars per year, those states and communities that look with small favor on the traffic in intoxicants, employing heavy excise dues either to keep the sale in responsible hands, or to make it unremunerative and thus virtually to prohibit it.

In the following states a license-fee of five hundred dollars or over is required: Arkansas, Illinois, Michigan, Minnesota, Missouri, Nebraska, Pennsylvania, Montana and Washington. In every state where liquor is permitted to be sold by private persons, a license fee is charged.

Civil-damage liquor acts are in force in many states, permitting husband, wife, child, parent, guardian or other person who has sustained injury or loss of support by any intoxicated person or in consequence of his intoxication, to maintain an action for damages in his or her name against any person who has sold or given intoxicating liquor

to the offender. This right of action is frequently extended against the owners of the premises in which the liquor is sold. These laws have been very generally held to be constitutional even when the state permits licenses for the sale of such liquor to be issued. Civil-damage acts have been passed in Illinois, Indiana, Iowa, Nebraska, Wisconsin, Michigan, New York, New Hampshire, Ohio, Kansas, Maine, Massachusetts, Vermont and other states.

The provisions above mentioned have been effectual to a greater or less extent, but none of them have succeeded in entirely abolishing the evils of intemperance. The failure of prohibition laws results from their ineffectual enforcement in localities where public opinion is not strongly in their favor, as is the case in large cities. Local option is less open to this difficulty, because this scheme is seldom adopted unless the opinion of the district involved is overwhelmingly favorable; yet here important difficulties arise. In many cases neighboring towns or localities where liquor is sold reap the financial benefits, while the evil is not materially lessened in the local-option district.

Two methods of handling the liquor traffic under a license system have attracted particular attention, one for its demonstrated control over saloons and the other for its promise. The first is known as the Brooks Law of Pennsylvania and the other as the Raines Law of New York.

The Brooks law was approved May 13, 1887, and it aimed by stringent measures to reduce the number of saloons and to place their management in the hands of responsible men, whose interest it should be to watch the traffic and insist on the enforcement of the law. Its distinguishing feature is the purpose to array liquor-dealers on the side of order. It had been the custom under the cheap-license system in Pennsylvania, as in many other states, for great brewers to supply the money to purchase the license and then to bind the licensee to sell their goods. The brewers desired as large a saloon constituency as possible, and they practically furnished the capital. The saloon-keeper under this plan is little more than a brewer's agent and his destitution makes him irresponsible. Enterprising men will not engage in the liquor business, the profits of which go to a powerful company or manufacturer behind him. The Brooks bill met the situation by requiring a license fee of \$500 in cities of the first class, of \$300 for those of the second class, although \$75 will procure a license in a rural township. No person can have more than one license, and in obtaining that he must swear that he has no interest in the profits of the sale of liquors in any other place in the county, and that no other person has a pecuniary interest in the business for which he asks a license. He can sell only in the place specified in his application, and if he transfers his license it must be with the permission of one of the excise judges, and his place of business goes with it. The statements of a petition for license must be veri-



fied by oath; the petitioner must have upon his application the indorsement of twelve qualified electors as to his character and veracity, and he must furnish a bond of \$2,000, with a power of attorney to confess judgment in his name for this amount, and also two sureties, who must be freeholders owning \$2,000 of realty over all incumbrances, for his observance of all the provisions of law relating to the sale of intoxicating beverages. Licenses are issued out of the Court of Quarter Sessions, the judges sitting openly on days publicly designated to hear petitions therefor. Applications must be filed in advance with the clerk of the court and advertised. Residents of the ward, borough or township are entitled to appear and contest the granting of any license on several grounds, as the character of the petitioner, the proximity of a church or school-house to the proposed saloon, or even that the saloon is not needed for the accommodation of the public. The usual provisions are incorporated against keeping open on Sundays or after midnight, against selling to minors, habitual drunkards or intoxicated persons, and against the patronage of disreputable or disorderly persons. The penalties are heavy and augment rapidly with each conviction for violation of the law. The operation of the law at once reduced the number of saloons to a third of the number under the old system, the arrests for disorderly conduct fell off notably, and the sales of liquor on Sunday in Pennsylvania ceased. The effects of the law are considered satisfactory by its friends.

The Raines Law was approved March 23, 1896. It aimed to destroy the ascendancy of the political machine in the large cities, particularly in New York and Brooklyn, so far as that rested upon control of dram-shops. Its characteristic feature is the "removal of the liquor trade from connection with local politics," and it is one of the measures of reform that followed the defeat of Tammany in New York, in 1894, and the election of Mayor Strong that year in the same city, by a union of citizens bent on good government. This law abolishes all local excise boards and places the control of the entire liquor business in the hands of a state commissioner; it forbids the free-lunch counter in saloons; it puts severe restrictions on the licensee, but protects him by drastic measures from being blackmailed by politicians or the police. Tax-payers are given an interest in the law by the provision that one third of the liquor money shall go into the state treasury, and the other two thirds to the cities, towns or counties where levied. It was estimated that the state proportion under the conditions prevailing in 1896, would be \$2,750,000, and such receipts were conjectured to be very potent as a relief to taxpayers.

The state commissioner is entitled to the services of four deputies and sixty inspectors. What was formerly called a license, under the Raines law becomes a tax: in other words, any one having the necessary qualifications as to character and securities for the observance of the

liquor laws of the state, may engage in the business, subject to an annual tax, and this tax is made so high that only men with something at stake can afford to pay it. Thus "the annual tax on an ordinary liquor-shop is in New York City, \$800; Brooklyn, \$650; all cities with a population between 500,000 and 50,000, \$500; between 50,000 and 10,000, \$350; between 10,000 and 5,000, \$300; between 5,000 and 1,200, \$200; all other places, \$100. There is no discrimination in the tax between the sale of spirits and the sale of wine and beer. Sunday opening is forbidden. No liquor-shop is to be within two hundred feet of a church building or a school-house. No *new* liquor-shop is to be allowed in a residence district without consent of two thirds of the property-owners. There are restraints on groceries and on clubs. Local option as to sale of liquors in cities is forbidden, but is granted to towns."

The high tax was expected to reduce the number of saloons by 40 per cent of their former number. The operation of this law is too recent for any analysis of the results, but one of the objects of the law was to displace the discretionary authority of excise boards with statutory specifications.

A novel liquor system was adopted in South Carolina in 1892, and it went into effect July 1, 1893. An amendatory act was passed the following year, in which some improvements were made. The principle of this system is entire state management of the traffic. The governor appoints a commissioner, whose duty it is to purchase liquor with the funds of the state and sell it to dispensers throughout the various counties. A state board of control consists of the governor, attorney-general and comptroller-general. Its duty is to take charge of the sale of liquor throughout the state. This board appoints county boards of control to supervise the business in the county and to appoint county dispensers. One dispenser may be appointed in each county, and such others as the county board, with the approval of the state board, may decide are necessary. But the freehold voters in any township may prevent the appointment of a dispenser for their township by presenting a petition to the county board signed by a majority of such voters. These dispensers are public officers, and are paid fixed salaries out of the receipts of the sales of liquor. The profits of each dispensary are divided equally between the county and town or city wherein it is located.

The dispensers may purchase liquor only from the state commissioner, who must sell to them at a profit not exceeding fifty per cent of the cost. His profits go to the state. The county dispenser must sell at a price not to exceed fifty per cent above the cost to him. They cannot keep open at night, nor sell to minors, habitual drunkards, or to any stranger unless he be identified by a reputable citizen. All sales must be made upon written request from the person desiring it, which request must state the name, age and residence of the applicant, and the quantity and kind of liquor

desired, and for whose use it is obtained, and must be signed by the applicant in his true name.

Printed blanks for requests are furnished to the dispensers, which must be accounted for, and which must be used in making requests for liquor. The county dispenser must make monthly reports and forward all requests which have been honored by him to the county auditor, who files them as records. Dispensers must be appointed upon petition, must be persons believed to be abstainers, must not be restaurant-keepers or keepers of places of public amusement, and must not have been convicted of violation of any state liquor law. Dispensers must sell only in original packages, which are furnished by the state commissioners in quantities ranging from one half pint to five gallons, and these packages can not be opened on the premises where they are sold. All liquors are tested by the chemist of the South Carolina College, and must be unadulterated. All liquor shipped must bear the certificate of the commissioner, whether shipped to a point in the state or outside of it, and it is unlawful for any carrier to transport packages of liquor without it bears such certificate. Dispensers and the commissioner are placed under heavy bond to carry out the law, and state constables are appointed to see to its complete observance.

**GOTHENBURG SYSTEM.** This dispensary plan is an adaptation of the Gothenburg system in Sweden, of which a brief account may be given. Its essential features are the elimination of private profit from the sale of spirits, placing public houses, chartered by the state, under the charge of official managers, while the profits are placed at the disposal of the commune for public improvements. The system has been tested in Norway and Sweden, and it has been claimed that the trade is kept within bounds, and that public morals have been distinctly improved. The nation benefits by the public works created out of the profits, as well as by the employment of laborers on these works. In 1894 the Norwegian Legislature adopted a system by which it was provided that 15 per cent of the profits realized should go to the communal treasury, 20 per cent to the chartered company to provide for the legal rate of interest on capital, and for donations in aid of temperance and charitable institutions, and the balance, 65 per cent, to the state. The act also provided a local veto clause by means of which a bare majority of those voting should decide for or against the continuance of the *Samlag* (association for the sale of liquor). On one occasion nine tenths of all the rural areas in Sweden voted against the *Samlag*. This reform act was passed to remove the grave objection to the system, viz., that the rate-payers endeavored to push the sale of liquor, and, consequently, to increase the profit, so as to reduce their taxes. A special fund has been proposed for the money which would accumulate under the operation of the act; and it was understood that the fund should be for old-age pensions. Mr. Joseph Ma-

Lodge, is strongly opposed to it, grounding his objection on the fact that under the system convictions for drunkenness had increased rather than diminished. He published his argument in the *Wesleyan Methodist Magazine* for October, 1895.

**LIQUOR QUESTION.** See INDIAN AFFAIRS, in these Supplements.

**LISBON,** a village and the capital of Ransom County, southeastern North Dakota, situated on the Cheyenne River and on the Northern Pacific railroad. It is the trade center of a rich farming, especially wheat growing, region, and has a foundry and flour-mills. Population 1900, 1,046.

**LIS PENDENS,** a phrase in law meaning literally, a pending suit, and as such affecting property and rendering the same incapable of sale or transfer during the pendency of the suit. The doctrine of *lis pendens*, complicated as it is by questions of absolute and constructive notice, is essentially a legal rather than a lay matter, and as such one for the consideration of a lawyer and his advice in all cases.

**LISSEN CEPHALA,** a term derived from the Greek, denoting a "smooth brain," or one deficient in convolutions. It was proposed by Owen as the name of a group or class of animals called by others the *Ineducabilia*, and in it he placed the *Edentata*, *Chiroptera*, *Insectivora* and *Rodentia*. The cerebral hemispheres are small, the cerebrum has few and simple convolutions, or more generally is smooth and does not cover the olfactory lobes of the cerebellum. It is part of a classification based on brain-structure, and has no general acceptance.

**LISTA-Y-ARAGON, ALBERTO,** a Spanish poet and critic; born at Triana, near Seville, Oct. 15, 1775. He was educated at the University of Seville, and in 1796 became professor of mathematics at the College of San Telmo, in Seville. He was obliged to flee from Spain during the Napoleonic wars; returned in 1817, and held professorships in Bilbao, Madrid, Cadiz and Seville. Among his works are *Poems* (1822); *Selections from the Best Spanish Writers of Prose and Verse*; and translations of the historical works of the Comte de Ségur. His critical doctrine may be said to be a compromise between French classicism and the literary theories of the romantic school. He died Oct. 5, 1848.

**LISTER, SIR JOSEPH,** an English surgeon; born at Upton, Essex, April 5, 1827; graduated in the academical department of the London University in 1847, and in the medical department in 1852; became a fellow of the Royal College of Surgeons, England, in 1852, and of the Royal College of Surgeons, Edinburgh, in 1855. He was successively assistant-surgeon and lecturer on surgery, Edinburgh; regius professor of surgery, Glasgow; professor of clinical surgery, Edinburgh; professor of clinical surgery, King's College Hospital, London, and was made surgeon extraordinary to the queen. In 1880 he received the royal medal of the Royal Society, and in 1881 the prize of the Academy of Paris, for his invaluable discoveries in anti-septic treatment in surgery known as "Listerism"; for

a description of which see SURGERY, Vol. XXII, pp. 678, 679. In 1883 he was created baronet. Among his works are *Remarks on a Case of Compound Dislocation of the Ankle with Other Injuries, Illustrating the Antiseptic Treatment* (1870), and *A Contribution to the Germ Theory of Putrefaction* (1875).

LISZT, JOHANN BENEDICT, a German mathematician and physicist; born in Frankfort-on-the-Main, July 25, 1808. He was teacher in a technical school in Hanover for two years, and from 1839 till his death held the chair of physics in the University of Göttingen. He made researches in the mathematics and physiology of optics and in the theory of knots (q.v., Vol. XIV, p. 127), in which he anticipated the labors of Tait. He died Dec. 24, 1882.

LISZT, FRANZ, a Hungarian pianist and composer; born at Raiding, Hungary, Oct. 22, 1811.



FRANZ LISZT.

His father was steward to Prince Esterhazy and was also an amateur musician. When his son was six years old he began giving him lessons on the piano-forte, and at nine the boy attracted so much attention by his playing that several Hungarian noblemen gave him the means for six years' study in Vienna.

Here he was put under Czerny and Salieri. In 1823 his father took him to Paris, hoping to place him in the Conservatoire, but, as admission was refused to him as a foreigner, he continued his studies in Paris under Reicha and Pärer, and at the same time aroused the enthusiasm of the musical world by his playing on the piano-forte. His father's good sense, however, prevented the boy from being spoiled by so much admiration, and restricted him to systematic study. In 1825 he made his first attempt at serious composition in the one-act operetta *Don Sanche*, which was well received. After his father's death in 1827 he fell a prey to morbid fancies, became a St. Simonian, but afterward returned to the Catholic Church. His enthusiasm was re-awakened by the violin playing of Paganini, and he began the career of virtuoso. From 1839 to 1847 he traveled continually from city to city, everywhere eliciting enthusiastic admiration and applause, which came alike from all classes, from the greatest musicians and the uncritical public. In 1848 he gave up this career and accepted the appointment of conductor of the Court Theatre in Weimar. Here he brought out the works of the new school of music, which up to this time had received but little attention from the public, and became the patron of several of the rising generation of musicians, notably of Richard Wagner, to whom he gave his daughter in marriage, and whose operas, *Tannhäuser*, *Lohengrin* and *Flying Dutchman* were produced under his management. Among his pupils on the piano-forte was Hans von Bülow.

At about this time he turned his attention seriously to composition, and began to write the works to which he owes his reputation as a composer. These include two concertos and 15 Hungarian symphonies; for orchestra, *Faust* and the *Divina Commedia* grand symphonies; the oratorio *St. Elizabeth*, the *Gran Mass*, the oratorio *Christus*, and numerous other sacred compositions, besides a number of songs, of which Heine's *Du bist wie eine Blume*, Goethe's *Ueber Allen Gipfeln ist Ruh* and Hugo's *Comment disaient-ils* are examples. In 1859 Liszt resigned his position at Weimar. In 1865 he took the orders of the Catholic priesthood, receiving the title of abbé, after 1871 residing principally at Pesth. Liszt was an author as well as musician, and in 1852-4 published a *Life of Chopin*, translated into English by Walter Cook (1877), essays on Wagner's opera, and a paper on *Bohemians and their Music in Hungary*. In 1845 he was decorated with the Cross of the Legion of Honor, and in 1861 was made commander. As a man, Liszt was impetuous and generous. Opinions vary as to the permanent value of much of his work, but his personal influence, especially on the younger musicians of his time, was very great. As a pianist his mastery of the instrument was phenomenal. He died in Bayreuth, Oct. 31, 1886.

LITCHFIELD, a manufacturing town and the capital of Litchfield County, northwestern Connecticut, on the Shepaugh, Litchfield and Northern railroad, 30 miles W. of Hartford. It has fine water-power, contains a soldiers' monument, and from 1784 to 1838 was the seat of Judge Tapping Reeve's celebrated law school, Judge James Gould conducting it after the death of its founder. The salubrity of its climate has made it popular as a summer resort. Near by are valuable beds of nickel ore; it manufactures paper, oil, satinets and nickel-ore smelters. It obtains water-power from Bantam Lake, just to the south. The township contains the villages of Bantam Falls, East Litchfield, Litchfield, Milton and Northfield. Pop. 1890, 1,058; 1900, 1,120.

LITCHFIELD, a city and railroad center of Montgomery County, southwestern central Illinois, 42 miles S. of Springfield, on Shoal Creek Basin, on the Jacksonville, Louisville and St. Louis, the Chicago, Peoria and St. Louis, the Wabash and the Cleveland, Cincinnati, Chicago and St. Louis railroads. It produces coal, natural gas and oil; has a good grain trade, contains an Ursuline convent, flour-mills, grain-elevators, car manufacturing and repairing shops, machine-shops, and carriage, threshing-machine, paint, broom, brick and tile and cider and ginger-ale factories. It has parks, a public library, electric lights and water-works. Population 1890, 5,811; 1900, 5,918.

LITCHFIELD, a post village and the capital of Meeker County, southern central Minnesota, 75 miles W. of St. Paul, on the Great Northern railroad. It has good water-power, a flour-mill, an iron-foundry and a furniture factory, and is situated in a fertile, undulating agricultural country. Population 1900, 2,280.

LITCHI OR LEE-CHEE (*Vepelium Litchi*) one

of the most delicate fruits of China, Cochinchina and the Malay Archipelago. The tree which produces it belongs to the family *Sapindaceæ*, and has pinnate leaves. The fruit is of the size of a small walnut, and grows in racemes. It is a red or green berry, with a thin, tough, scaly rind and a colorless pulp, in the center of which is one large dark-brown seed. The pulp is slightly sweet. The Chinese preserve the fruit by drying.

LITHARGE, an oxide of lead. See LEAD, Vol. XIV, p. 376.

LITHODOMUS, LITHODOME (Gr., "stone-house"), a mytiloid, mussel-like bivalve, cylindrical in form, with a wedge-shaped termination facilitating perforation of limestone, coral and shells, in which it burrows freely. The excavations, at first small and shallow, become enlarged with the growth of the shell, sometimes attaining a length of two or three inches.

LITHOGRAPHY. The art of lithography is in the main the same to-day as it was twenty years ago. There have been, however, some improvements made in the method of placing the drawing upon the stone. In most shaded drawings there are considerable spaces where the desired effects of shading are simple and uniform. These are produced by lines, grains and stipples. The work of filling in these spaces takes considerable time. In order to save this time the required markings are molded in points or short, narrow ridges on one face of a rubber sheet, similar to the working side of a rubber stamp. This molded face is then inked and laid flat upon the stone, while pressure is brought upon the back of the corresponding portion of the rubber sheet. In this way the markings on the inked side are transferred to the stone with much greater rapidity than can be done by hand-work. Besides, the shadings thus produced are more perfect and regular than shadings drawn on the stone by hand. Another process by which drawing upon the stone is facilitated, is the employment of the "air-brush." A tube is connected with a bellows worked by the foot. This tube has a fine nozzle through which a continuous current of air is blown out. A smaller tube conveys ink to the aperture of the air-tube. This ink is blown out by a current of compressed air in the form of a fine spray, exactly in the same way as liquids are sprayed out of an atomizer. As this approaches the stone, the line of ink becomes narrow and dark. As it is lifted farther away from the stone, the ink-spray widens, and grows thinner and paler, so that any variety of effect, from the lightest field to the darkest shading, can be readily produced, and with a rapidity far beyond that of the old method of drawing upon the stone. The flow of ink can also be increased or diminished by simple pressure of the fingers, thus rendering it possible easily to produce uniform fields of strong shades or bright light.

Some attempts have recently been made to use aluminium in lithography instead of the ordinary lithographic stone. The employment of the former, however, has not gone further than the experimental stage as yet, though if found practi-

cable it will possess great advantages over the old method. It is asserted that drawings can be fixed on aluminum as easily as on stone, and the metal possesses the advantage of being lighter, and, since it can be melted and re-rolled, very much cheaper. Moreover, as it is malleable it may be bent or curved for use on modern, high-velocity, rotary presses. The experiments in aluminum will be hastened, no doubt, by the reports that the quarries at Solenhofen, Bavaria, which have hitherto supplied the world, are beginning to be exhausted. It is said, however, that there have been opened in Tennessee quarries practically inexhaustible, from which stones have been taken equal in quality to the Solenhofen products. See LITHOGRAPHY, Vol. XIV, pp. 697-701.

LITITZ, a post borough of Lancaster County, southeastern Pennsylvania, on the Philadelphia and Reading railroad, 27 miles S.W. of Reading; founded by the Moravians, in 1756. It has several boarding-schools and seminaries, including Linden Hall Seminary, which has a library of four thousand volumes, has a fine mineral spring and is a summer resort; it has manufactories of beer, cigars, flour and machinery. Population 1900, 1,637.

LITOLFF, HENRI CHARLES, an English pianist and composer; born in London, Feb. 6, 1818. His father, an Alsatian, was a soldier who was taken prisoner and carried to England, where he afterward settled as a violin-player and married an Englishwoman. At 12 the son showed great talent in pianoforte playing, and was taken as a pupil gratis by Moscheles. He made his first appearance at Covent Garden Theater in 1832. At 18 he contracted a marriage which his parents had forbidden, and went to live in France. For some time thereafter he led a wandering life, giving concerts in the principal European capitals with great success. His first wife having died, he married Madame Meyer, the widow of a music-publisher of Brunswick, where he settled and continued the business. Here his adopted son Theodor, to whom he transferred the management of affairs, began the publication of cheap but accurate editions of classical music, the first of many such which have since been published. Having been divorced from his second wife, he moved to Paris in 1860, and married the daughter of the Count de la Rochefoucauld. As a pianist Litolff ranked high, possessing passion and brilliancy of execution, though often unequal and inaccurate. The same fault is noticeable in his compositions. They contain beautiful and poetic ideas and are remarkable for their originality, but are full of imperfections. Among his best works is the *Spinnlied*. He composed among others, the operas *Héloïse et Abelard*, *Les Templiers*; *King Lear*. Died at Bois-Colombes, near Paris, Aug. 6, 1891.

LITTELL, ELIAKIM, an American publisher; born in Burlington, New Jersey, Jan. 2, 1797. Having learned the printer's trade, he established at Philadelphia, in 1819, a literary paper entitled the *National Recorder*, changing the name in 1821 to the *Saturday Magazine*. In 1822 it became a monthly, called the *Museum of Foreign Literature*

*and Science.* It presented to American readers selections from the best periodical literature of Europe. After conducting this successfully for twenty-one years, he began to publish, in 1844, in Boston, *Littell's Living Age*, a weekly literary periodical of high character and taste, which is still continued. He died in Boston, May 17, 1870.

**LITTLE COLORADO RIVER.** See **COLORADO RIVER**, Vol. VI, p. 163.

**LITTLE CROW**, a hereditary chief of the Sioux Indians; born near St. Paul, Minnesota. After 1851, when the Sioux, by treaty, ceded their lands beyond the Mississippi River to the government, they were removed to reservations in northern Minnesota. Here, in 1862, the Indians suddenly rose in a body, and along the frontier line of more than two hundred miles in extent, slew men, women and children to the number of one thousand. Little Crow was the acknowledged leader and instigator of this horror. On Sept. 23, 1862, the United States forces under General Henry H. Sibley met the Indians and defeated them, took 2,000 prisoners and released 120 white female prisoners. About forty Indians were hanged, and the others removed to the Missouri River. Little Crow and several hundred of his followers fled with their families and took refuge among other neighboring bands, where for a time they dwelt in concealment. In 1863 the chief was discovered while on a raiding expedition, and shot. His scalp is in the collections of the Minnesota Historical Society. His death occurred near Hutchinson, Minnesota, in 1863.

**LITTLEDALE**, RICHARD FREDERICK, an Irish clergyman; born in Dublin, Sept. 14, 1833. He was graduated at Trinity College, Dublin, in 1854, ordained in 1856; was curate at St. Mary Virgin, Soho, 1857-61. He was obliged to give up his parochial work in 1861 on account of chronic ill-health, and after that year devoted his entire attention to literature, writing upon ecclesiastical subjects. His works include *Religious Communities of Women in the Early Church* (1861); *The Mixed Chalice* (1863); *The Catholic Ritual in the Church of England* (1865); *Plain Reasons Against Joining the Church of Rome* (1879). He contributed articles to this **ENCYCLOPÆDIA** on church history and theology, among them the articles on *Jesuits*, *Council of Trent*, and *Vatican Council*. He died Jan. 11, 1890.

**LITTLE FALLS**, a town and the capital of Morrison County, central Minnesota, located on the E. bank of the Mississippi, 97 miles above Minneapolis, on the Northern Pacific railroad. It is in a forest and grain-growing region, with good water-power and several manufactories. Population 1890, 2,354; 1900, 5,774.

**LITTLE FALLS**, a picturesque post village of central New York, on both sides of the Mohawk River. Population 1890, 8,783; 1900, 10,381. See also **LITTLE FALLS**, Vol. XIV, p. 703.

**LITTLE KANAWHA RIVER.** See **WEST VIRGINIA**, Vol. XXIV, p. 518.

**LITTLE ROCK**, the capital city of Arkansas and of Pulaski County, situated on the S. bank of

the Arkansas River, near the center of the State. It is on the St. Louis, Iron Mountain and Southern, the Little Rock and Memphis, and the St. Louis Southwestern railroads, all of which have repair-shops here. The city contains a handsome State capitol, a Roman Catholic Academy, Arkansas Female College, Philander Smith College



THE CAPITOL, LITTLE ROCK.

(Methodist Episcopal, founded 1877), the Sherman high-school for white and the Union high-school for colored pupils; a convent, the Roman Catholic Cathedral of St. Andrew, etc. The principal articles of manufacture are flour, castings, wagons, cotton, cotton-seed oil, furniture and machinery. There are granite quarries here. The streets are well paved, and are lighted with electricity and gas and have electric railways. The city is supplied with water and sewer systems, and has a public library of 82,000 volumes. Population in 1890, 25,874; 1900, 38,307. See also **LITTLE ROCK**, Vol. XIV, p. 703.

**LITTLE RUSSIANS.** See **RUSSIA**, Vol. XXI, pp. 79, 80, 109, 110.

**LITTLE THIBET.** See **LADAK AND BALTI**, Vol. XIV, p. 198.

**LITTLETON**, a post village and township of Grafton County, northern New Hampshire, on the Mink or Ammonoosuc River, 28 miles from Mt. Washington, on the Boston and Maine railroad. On account of its picturesque scenery and healthful climate it is much visited by tourists to the White Mountains. The town has manufactories of woolen goods, axes and scythes. Population 1890, 3,365; 1900, 4,066.

**LITTLETON**, ADAM, an English lexicographer, born at Halesowen, Worcestershire, Nov. 8, 1627. He was educated at Christ Church, Oxford, and in 1669 became rector at Chelsea, in 1670 chaplain of Charles II; rector of the Church of St. Botolph, Aldersgate, from 1685 to 1689. He wrote on philological subjects, made several translations from the Latin and Greek, and published sixty-one sermons. His greatest work is his *Latin, Greek, Hebrew and English Dictionary* (1678, several times reprinted). He also made a fine collection of rare books and manuscripts. He died June 30, 1694.

**LITTLE TURTLE**, a chief of the Miami Indians. It is thought that he received the rudiments of an education in a Canadian Jesuit school. He was remarkable both for his intelligence and for his prowess in war. He defeated General Harmar on the Miami River in 1790, and General St. Clair at St. Mary's on November 4 of the fol-

lowing year. After trying to dissuade his friends from forcing an engagement, he took part in the battle of Fallen Timbers on Aug. 20, 1794, when the Indians were defeated by Anthony Wayne, the "Chief who never sleeps." In 1795 he signed the treaty of Greenville, which ended the war. In 1797 he made a visit to Philadelphia, and there met President Washington, Count Volney and others. He died in Fort Wayne, Indiana, July 14, 1812.

LITTORALE. See KÜSTENLAND, in these Supplements.

LIVADIA, the ancient *Lebadea*, a town of Greece near the cave of Trophonius, seat of the ancient oracle, 60 miles N.W. of Athens. Population, 5,000. See ORACLE, Vol. XVII, p. 808.

LIVER. See DIGESTIVE ORGANS, Vol. VII, pp. 229-231; Diseases of, see PATHOLOGY, Vol. XVIII, pp. 385, et seq.

LIVERMORE, MARY ASHTON RICE, an American woman's suffrage lecturer and authoress; born in Boston, Massachusetts, Dec. 19, 1821. She was educated in the young ladies' seminary at Charlestown, and became a governess in Virginia. She returned to Massachusetts; taught school at Duxbury; and later married Daniel P. Livermore, a Universalist minister. In 1862 she was appointed an agent by the United States Sanitary Commission, and traveled through the Northwest, organizing sanitary societies. In the following year she made a tour of the camps and hospitals on the Mississippi, and took an active part in the organization of the Northwestern Sanitary Fair in Chicago in 1863, by which \$100,000 was raised for the Commission, \$3,000 of which being realized by the sale of the original draft of Lincoln's emancipation proclamation. After the war, Mrs. Livermore lectured on woman's suffrage, and in 1870-71 was editor of the *Woman's Journal*. She published *Pen Pictures* (1865); *Thirty Years too Late* (1878); and *My Story of the War* (1888).

LIVERPOOL, the greatest seaport, and next to London the wealthiest city in Great Britain, is situated in Lancashire, on the right or east bank of the Mersey, three miles from the Irish Sea, three quarters of an hour by rail from Manchester, four and a half hours from London, six from Edinburgh and eight by steamer from Dublin. It is faced by the thriving town of Birkenhead, and lies on five hills, sloping toward the river, which is crowded with shipping and bordered by the grandest range of docks in the world. The estuary is here three quarters of a mile wide, and a system of steam ferry-boats and an underground railway keep up a constant communication, day and night, between the two shores. Liverpool now contains an unusual number of splendid buildings, but, partly on account of the inequalities of its site, is rather wanting in long, broad, stately streets. In the fashionable east end there are several fine large squares, and on the outskirts of the town are six public parks—the Prince's, the Botanic Gardens, the Sefton, the Stanley, the Newsham, and the Sheil; and it has

been proposed to connect these by a continuous belt of boulevards. Altogether, £700,000 has been expended on these "lungs" of the city, which cost some £12,000 annually to maintain. The finest street, architecturally, is Lime Street, in the very heart of Liverpool, on one side of which stands St. George's Hall, the principal building in the city. The Sailors' Home, comprising a library, navigation school and savings bank, is the residence of some 8,000 sailors every year. A nautical college was founded in 1892, and at this institution boys are taught and men are prepared for service examinations in the mercantile marine. There are in Liverpool and out-townships over three hundred and fifty places of worship, belonging to the Church of England, Roman Catholics, Baptists, Congregationalists, Wesleyans, Unitarians, etc., English and Scotch Presbyterians, and churches and Dissenting chapels in which the service is conducted in Welsh, Catholic Apostolic and Greek Churches, and synagogues, one of which is among the finest structures in the town. The see of Liverpool was created in 1880, with an endowment of £100,000. Of these the chief are the Bluecoat Hospital, maintaining and educating 350 children, the Orphan Asylum, the Seamen's Orphan Asylum in Newsham Park (1874), containing about 400 boys and an equal number of girls; schools for the Blind and the Deaf and Dumb, Industrial schools, the Royal Infirmary, the Northern and Southern hospitals (the latter opened in 1872), Lying-in, Homœopathic, Eye and Ear institutions, and Children's Infirmary. There are several theaters, and high-class concerts are held in St. George's and the Philharmonic halls. Liverpool has daily and weekly newspapers and literary periodicals, besides the *Daily Telegraph and Shipping Gazette* and the *Journal of Commerce*. Railway lines run through the town to the docks in tunnels under the houses; the Lancashire and Yorkshire railway is carried above the houses on a splendid viaduct to Tithebarn Street Station. The Midland has a handsome station, and the London and North-Western (Lime Street) is not only the largest in Liverpool, but one of the largest in the world. The area of the docks and quays is estimated at 1,105 acres and the length of quay space at 25 $\frac{2}{3}$  miles. The total income for rates and dues on ships and cargo paid to the docks in 1894 amounted to £1,130,000. The docks present to the river an unbroken line of over six miles, having in the north the Canada and in the south the Herculeum docks, and flanked by the Custom House, one of the finest in the kingdom, and by the tall row of the Albert Dock warehouses, erected at a cost of £358,000. The North Docks ("Langton" and "Alexandria") were opened by the Prince of Wales, 1881. There are over 60 docks and basins, all save four constructed since 1812. The Canada and Herculeum docks are devoted exclusively to timber, the King's to tobacco, and the Queen's to cotton, dye-wood, jute and other East and West Indian

products; the George is mainly used for export purposes; the Victoria, Clarence and Trafalgar by steamers engaged in the Irish trade, while the Nelson, Salisbury and Bramley Moor docks are occupied by steamships trading to the West Indies, the Pacific, Mediterranean, and to Dutch and German ports. The Corn docks, capable of holding the largest vessels in the grain trade, are provided with a range of splendid warehouses, to hold 165,000 tons of corn, ten stories high, with water-tight and rat-proof cellars, and elevating machinery, worked by hydraulic power, able to transfer from the ships 250 tons per hour. The "quantities" of timber imported annually exceed—of yellow pine, 2,060,000 cubic feet; of Quebec oak, 1,058,000; of birch, 431,000; of pencil cedar, 66,850; of mahogany, 7,000,000; of spruce deal and boards, 84,222 "standard" (of 165 cubic feet apiece); from the Baltic, 646,000 cubic feet of fir logs and 391,400 cubic feet of pitch pine. About four-fifths of all the traffic between North America and Great Britain is carried on through Liverpool, which has also a large share of the Eastern and Australian trade. Liverpool is the greatest cotton market in the world. It is also the second largest wool market in the country. The chief exports are cotton manufactures, cotton yarn, woolen manufactures, linens, iron, hardware and cutlery, haberdashery and millinery. In 1894, 488 sailing-vessels (347,282 tons) and 2,831 steamers (4,289,631 tons) entered, and 459 sailing-vessels (311,495 tons) and 2,311 steamers (3,708,451 tons) entered from and cleared to foreign countries. In the same year 180 sailing-vessels (149,263 tons) and 374 steamers (706,169 tons), and 240 sailing vessels (228,624 tons) and 396 steamers (748,681 tons) entered from and cleared to British possessions and protectorates. Besides its enormous trade, Liverpool has a vast passenger traffic with New York and other North American ports, in addition to those of the Pacific, Mediterranean, India, etc. The Cunard Company alone has over 50 vessels, half of which are employed in the Atlantic service. Other celebrated lines are the National, the White Star, the Inman, the Guion, the Dominion, the Allan and the Anchor, each of which has greatly increased the size, speed and number of its vessels of late years. There is also an extensive local steam-packet service daily to Dublin and Belfast, twice or thrice weekly to Cork, the Isle of Man, Glasgow, etc. The great center of the passenger traffic is the famous Landing Stage, a vast pontoon, dominating the Mersey, from which tenders convey their complement to the large steamers lying out in the river, and where there is a constant bustle about the steam ferry-boats. It is little short of a mile in length. A railway tunnel under the Mersey, to afford more direct communication with Birkenhead, Cheshire and the South, was opened Feb. 13, 1885, and a ship-canal to connect Liverpool with Manchester was commenced Nov. 11, 1887, and opened in 1894. There are extensive sugar refineries, shipbuilding-yards, iron and brass

foundries, engineering works, rice, flour and saw-mills, cigar factories and manufactures of chain cables, anchors, cordage, chemicals, soap, glass, spirits, nautical instruments, etc. The market accommodation of Liverpool is superior even to that of the metropolis. Messrs. Hawksley and Deason impounded the waters of the river Vyrnwy, in North Wales, some forty-five miles distant from Liverpool, and made a lake of 1,121 acres, which now supplies about 13,000,000 gallons daily to the city. The water was turned on in 1892, and the cost of the whole undertaking is estimated at £2,150,000. An overhead railway, extending the whole length of the docks, was opened in 1893. University College has 50 professors and teachers and 482 students (1895). Liverpool sends nine members to Parliament. In politics it is strongly Conservative. Its merchant-princes, as a rule, are men of old family, long connected with the city, and claiming descent from the landed families of Lancashire. Population 1800, 77,708; 1831, 205,572; 1861, 443,938; 1891, 517,980. The Parliamentary borough contains nine divisions, each of which returns one member. These are Abercromby, population 55,530; East Toxteth, 63,677; Everton, 78,285; Exchange, 47,738; Kirkdale, 77,372; Scotland, 53,713; Walton, 66,503; West Derby, 76,971, and West Toxteth, 64,710. Population of Liverpool, estimated for 1898, municipal borough, 633,645. See also LIVERPOOL, Vol. XIV, pp. 712-17.

LIVERPOOL, a post village of Onondaga County, central New York, on the east shore of Onondaga Lake, on Oswego canal and on the Rome, Watertown and Ogdensburg railroad. It has salt-works, and manufactures cigars and willow baskets. Population 1900, 1,133.

LIVIA DRUSILLA, wife of Augustus and mother of TIBERIUS; q.v., Vol. XXIII, pp. 335-337.

LIVINGSTON, a city and the capital of Park County, southern central Montana; situated at a railroad junction on the Northern Pacific railroad and on the Yellowstone River, 100 miles S.E. of Helena. From here a branch of the Northern Pacific railroad runs down to the National Park. It has railroad car-shops, and is surrounded by a farming community; stock-raising and coal and gold mining are engaged in. Population 1890, 2,850; 1900, 2,778.

LIVINGSTON, PHILIP, a signer of the Declaration of Independence; born at Albany, New York, Jan. 15, 1716. After graduating at Yale College he became a merchant in New York, and was for nine years an alderman of that city. From 1758 to 1769 he was a member of the provincial assembly, in which he steadily opposed all arbitrary measures of the mother country. In 1774 he was delegated to the Continental Congress, then assembled at Philadelphia, and continued to be a member of that body until his death. As such he signed the Declaration of Independence in 1776. Mr. Livingston was liberal to colleges—a professorship of divinity at Yale bears his name as one of its founders—and during the Revolutionary War he sold part of his

property in order to sustain the public credit. He was one of the contributors to the building of the first Methodist church in America, and one of the founders of the New York Chamber of Commerce. He died in York, Pennsylvania, June 12, 1778.

LLANDAFF, HENRY MATTHEWS, VISCOUNT, an English statesman and jurist; born in 1826, in Ceylon, where his father, Henry Matthews, was a puisne judge. He was educated in the Universities of Paris and London, and was called to the English bar at Lincoln's Inn. He was appointed a Queen's counsel in 1868, and from 1872 to 1876 acted as examiner to the Council of Legal Education. In his forensic career he was engaged in many noted lawsuits, among others the Tichborne case and the Crawford-Dilke divorce case. Thrice he essayed to represent the borough of Dungarvan in the Imperial Parliament before he sat for it from 1868 to 1874. At the general election of 1886 he had the distinction of winning the seat for East Birmingham, being the first Conservative who ever sat for that stronghold of sturdy radicalism. On the formation of Lord Salisbury's second ministry he became Home Secretary, and by his resolute enforcement of capital punishment in several notorious murder cases and his invariable defense of the police, he raised many storms of adverse criticism in the sensational newspaper press. In 1892 he was again returned for East Birmingham; and in 1895 he was raised to the peerage as Viscount Llandaff.

LLANO ESTACADO OR STAKED PLAIN. See TEXAS, Vol. XXIII, pp. 202, 203.

LLANQUIHUE, province and lake of CHILE. Vol. V, pp. 616, 622.

LLEWELYN AP GRIFFITH, a prince of Wales, who succeeded his uncle, David II. He fought with the barons under Simon de Montfort in their contest with Henry III, defeated Mortimer in 1264, and made peace with the king three years later. He refused to do homage to Edward I, who made war on him and forced him to surrender Wales to the English. He was allowed, however, to marry De Montfort's daughter, to whom he had been affianced, and who was captured by the English. He renewed the war in 1282, and was killed in battle the same year.

LLOYD, CHARLES HARFORD, an English musician; born Oct. 16, 1849, at Thornbury, Gloucestershire. He was educated at Magdalen Hall (now Hertford College), Oxford, graduating Mus.B. in 1871, B.A. 1872, and M.A. 1875. While an undergraduate he was one of the founders of the Oxford University Musical Club, and became its first president. He was appointed organist of Gloucester Cathedral in 1876, and in 1882 of Christ Church Cathedral, Oxford. Among his compositions are *Hero and Leander* and *Song of Balder*, cantatas; the music for *Alceste*; *The Gleaners' Harvest* for chorus of female voices; the anthem, *Art Thou Wary?* and a *Sonata in D Minor* for the organ, besides part-songs, madrigals, etc.

LLOYDS. See FIRE INSURANCE, in these Supplements.

LOADSTONE. See MAGNETISM, Vol. XV, p. 274; and IRON, Vol. XIII, pp. 285-287.

LOAM, a clay. See *Kaolin*, under MINERALOGY, Vol. XVI, p. 424; Loamy Soil, see HORTICULTURE, Vol. XII, pp. 232, 218.

LOAN, a bailment of an article or a sum of money, either with or without reward. As applied to an article of personal property, it generally signifies a bailment without reward; but it may and frequently, as in the case of a loan of money, does include a bailment with reward. A loan may be for consumption and a return in kind, or for use with a return of the specific article loaned. In case of a loan without reward, and for use merely, the borrower may use the article during the time for the purpose and to the extent contemplated by the parties, but may not, as a rule, permit others to use it. He is bound to use extraordinary care and diligence in preserving the property, and must return it at the time and place agreed upon. The lender, when the property is loaned without reward, may terminate the loan at his pleasure. In case of a loan for use and for reward, commonly called hiring, the borrower is bound to use only ordinary care in protecting the property. Loans for consumption or for which a return in kind is to be made, of which a loan of money is an example, partake more of the nature of a sale or exchange. The property passes to the borrower absolutely, and he is expected to return like property of equal value. For a discussion of the subject under the Roman law, see ROMAN LAW, Vol. XX, pp. 701, 702; see also NATIONAL DEBT, Vol. XVII, pp. 243-247; and COMMERCE, Vol. VI, pp. 206, 207.

LOAN AND BUILDING ASSOCIATIONS. See BUILDING SOCIETIES, Vol. IV, pp. 513, 514; and BUILDING AND LOAN ASSOCIATIONS, in these Supplements.

LOBANOFF-ROSTOFKI, PRINCE ALEXIS BORISOVICH, Russian statesman and diplomat; born in Rastoff, Dec. 30, 1824.

He was a member of one of the leading Russian families, and received his education at the principal government school. He entered the Foreign Office in 1843; and in 1847 was appointed chief secretary to the foreign minister. He was a member of the Russian embassy to Berlin in 1850; in 1856 joined the legation at Constantinople; and three years after was



PRINCE LOBANOFF.

minister plenipotentiary to the Porte. In 1863-66 he was in private life, and in 1866 he entered the service of the Interior Department, serving first as governor of Orel, and later as adlatus to the Minister of the Interior. In 1878 he reentered the Foreign Office service as ambassador to the Porte; in 1879 was transferred to London; and in 1882-95 was ambassador at Vienna. He accepted the office of Minister of Foreign Affairs, made vacant by the death of M. de Giers in 1895. As ambassador to three of



the most important courts of Europe, at times when the slightest indiscretion on his part might have precipitated a war, Prince Lobanoff conducted himself in his office so that he won the admiration of those governments most interested and of all with whom he came in contact. After taking office as foreign minister he displayed great activity and tact, and in the short time of his service did much to elevate Russia in the rank of nations. He aided the Balkan principalities, restrained the Japanese, and brought about peace between Bulgaria and Servia. In the performance of these multifarious labors for his country he died at Scheptowka Station, Austria, while accompanying the Czar from Vienna to Kieff, Aug. 30, 1896.

LOBAU, an island in the Danube near Vienna. In 1809 it was the scene of an important encounter between French and Austrian forces. See AUSTRIA, Vol. III, pp. 133, 134.

LOBDONUM. See INCENSE, Vol. XII, p. 718; and LADANUM, in these Supplements.

LOBECK, CHRISTIAN AUGUST, a German classical scholar; born in Naumburg, June 5, 1781. He was private instructor at Wittenberg in 1802; professor in 1810; professor and librarian at Königsberg after 1814. He was the author of *Paralipomena Grammaticæ* (1837); *Pathologia Sermonis Græci Prolegomena* (1843); and *Aglaophamus* (1829), on Greek mysteries, which has been the basis of all works on the same subject since. See MYSTERIES, Vol. XVII, p. 124.

LOBEIRA, BASCO, a Portuguese author; born in Oporto about 1360. He was knighted by King John I, on the battle-field of Aljubarrota, in 1386. Lobeira was the author, or at least the first translator into Portuguese, of the *Amadis de Gaul*, the first of a long series of romances of chivalry, very popular for a time in Portugal and Spain, to ridicule which Cervantes' *Don Quixote* was written. It is asserted that the romance originated first in France, but Lobeira's version is at least the first of which we have any definite knowledge. He died in 1403. See AMADIS OF GAUL, Vol. I, p. 650.

LOBEL OR DE L'OBEL, MATHIEU, an English botanist and physician to James I of England; born at Lille, in Flanders, in 1538. He studied medicine at Montpellier, and became physician to the Prince of Orange, and, after the death of the latter, settled in England and became the physician of King James. In 1870 he published, with Pierre Pena, the French botanist, *Stirpium Adversaria*, which was, perhaps, the first attempt at a natural method of botany; in 1576 *Plantarum seu Stirpium Historia*; in 1581, *Icones Stirpium*. The genus *Lobelia* was named after him. He died at Highgate, London, March 2, 1616.

LOBLOLLY BAY. See GORDONIA, in these Supplements.

LOB NOR. See TURKESTAN, Vol. XXIII, pp. 637, 638.

LOBO, FRANCISCO ALEXANDRE. See PORTUGAL, Vol. XIX, p. 558.

LOBOSA, class of PROTOZOA, Vol. XIX, pp. 841-843.

LOBOSDEAFUERA AND LOBOSDE TIERRA,

two small groups of rocky islands off the coast of Peru, the first in lat. 6° 56' S., long. 80° 44' W., and the second in lat. 6° 29' S., long. 81° 10' W. They abound in guano, being among the few Peruvian islands whose supply has not given out. Their population is small.

LOBSTER. See CRUSTACEA, Vol. VI, pp. 657, 658; and FISHERIES, Vol. IX, p. 265.

LOCAL GOVERNMENT ACT, for England and Wales. This act, involving great changes in the laws and government administration throughout England and Wales, was introduced in the British Parliament by Mr. Ritchie, president of British Local Government Board, on March 18, 1888.

When the bill was returned to the House of Commons the changes made by the House of Lords were accepted, and the bill received the royal assent Aug. 13, 1888.

The new act provided as follows:

A council should be established in every administrative county, as defined by this act, and intrusted with the management of the administrative and financial business of the county, and should consist of the chairman, aldermen and councilors. Three fourths of the members of the council (the councilors) were to be elected by the burgesses and electors throughout the county for three years; the other fourth (the county aldermen) were to be selected by the councilors. There was to be transferred to the county council all business done by the quarter sessions in respect of the following matters: The making, assessing and levying of a county, police, hundred and all rates, and the application and expenditure thereof, and the making of orders for the payment of sums payable out of any such rate or out of the county stock or county fund, and the preparation and revision of the basis or standing for the county rate; the borrowing of money; the passing of the accounts of and the discharge of the county treasurer; shire halls, county halls, assize courts, judges' lodgings, lock-up houses, court-houses, justices' rooms, police stations and county buildings, works and property, subject, as to the use of buildings by the quarter sessions and the justices, to the provisions of this act respecting the joint committee of quarter sessions and the county council; the licensing, under any general act, of houses and other places for music or for dancing, and the granting of licenses under the Race-courses Licensing Act (1879); the provision, enlargement, maintenance, management and visitation of and other dealings with asylums for pauper lunatics; reformatory and industrial schools; construction and repair of bridges and roads repairable with bridges, fixing the fees of inspectors and analysts; appointment of county treasurer, county surveyor, public analysts, coroners and health officers, and the determination of their salaries; the division of the county into coroners' districts, and the assignment of such districts; the division of the county into polling-districts for the purposes of Parliamentary elections, the appointment of places of election, the places of holding courts for the revision of the lists of voters and the costs of and other matters to be done for the registration of Parliamentary voters; the execution as

local authority of the acts relating to contagious diseases of animals, to destructive insects, to fish conservancy, to wild birds, to weights and measures and to gas-meters, and of the Local Stamp Act (1869); any matters arising under the Riot (damages) Act (1866); the registration of rules of scientific societies; the registration of charitable gifts under 52 Geo. III, ch. 102; the certifying and recording of places of religious worship under 52 Geo. III, ch. 155; the confirmation and record of the rules of loan societies under 3 and 4 Vict., ch. 110; and any other business transferred by this act.

The duties collected by the commissioners of inland revenue in each administrative county were made payable to the county council, and also four tenths of the probate duties. Also, the county councils were authorized to pay all officials heretofore paid by local grants.

The mayor, aldermen and burgesses of each county borough, subject to certain modifications, were given all the powers of a county council under the act, in so far as they were not before in possession of or subject to the same, but they were still to be governed in many respects by Municipal Corporations Act; and the provisions of the Local Government Act with respect to the constitution, election, proceedings or position of the county council or the chairman thereof, the county treasurer and other county officers, the standing joint committee of the justices and the council, coroners, gas-meters, the transfer to the council of powers relating to county and other rates and the preparation or revision of the basis or standard for the county rate, were not to apply to county boroughs. Provision was made for an adjustment of the financial relations between counties and county boroughs by agreement or by the commissioners appointed under the act.

The Local Government Act (1894), which received the royal assent March 5th of that year, completed the scheme of local government inaugurated by the Local Government Act of 1888. The latter act not only provided for district councils, the plan for which had to be abandoned in the original act, but also set up a new parochial organization in the rural districts, instituting, in connection with the new bodies, a franchise of a very wide character, which, however, has not been extended to the county council elections. This act, popularly called the "Parish Councils Act," was introduced in Parliament in the session of 1893. It also conferred on the county councils many new powers and duties, in addition to those conferred by the act of 1888. Before the passage of this act, parish affairs, so far as they were popularly managed at all, were controlled by the freeholders or rate-payers, who had from one to six votes, according to their property qualification, in the vestry. Powers of the vestry, however, were extremely limited. One of the chief changes of the new act was the establishment, in parishes situated in rural sanitary districts, of parish meetings and parish councils, into whose care was given all the secular business of the vestry. The franchise was extended from freeholders to all persons registered in the parish as Parlia-

mentary electors, including: freeholders, to the value of 40 shillings annually; freeholders for life with holdings of an annual value of £5; copy-holders for life, with holdings of an annual value of £5; leaseholders, for sixty years or more, of leases worth annually £5; leaseholders, at will, of leases worth annually £50; occupiers, as owners or tenants of lands worth annually £10; occupiers, of any dwelling worth annually £10; occupiers, as lodgers in rooms worth annually £10. An elector cannot vote more than once in any parish, but can vote in as many parishes as he has the necessary qualifications. Councils were established in all rural parishes with a population of 300 or over, and made optional with the parish meeting in parishes with a population between 100 and 300. The council constituted to have a chairman and five to fifteen councilors, all of them parochial electors. The council was given power to hold lands; to borrow money; to appoint overseers of the poor; to rate owners; to nominate constables; to decide appeals from overseers; to maintain footpaths, etc.

Rural district councils and urban district councils were established by the act to succeed to the powers of the old rural and urban sanitary authorities, with the same increased franchise. Both married and single women having the necessary property qualifications can vote at parish meetings, and are eligible for election as parish councilors.

Among the additional powers conferred by the act of 1894 on county councils were those of establishing parish councils; fixing the number of parish councilors; fixing or altering number of rural or urban district councilors; dealing with default of district councils; custody of parish books; retirement of councilors, etc.

LOCAL GOVERNMENT BOARD of England and Wales. This board, first constituted Aug. 19, 1871, under an act passed earlier in the same year, was established to take over all the powers and duties vested in or imposed on the Poor Law Board. It assumed the functions of the Home Secretary under the Registration Acts, the Sanitary Acts, the Local Taxation Acts, and the duties of the Privy Council under the Prevention of Diseases and Vaccination Acts. Since that time its powers have been increased and its sphere and operations extended by many statutes. The board consists of a president and of certain *ex officio* members, all of whom are members of the government for the time being. The president is assisted by a Parliamentary secretary, a permanent secretary and a numerous staff of officers, inspectors, etc. The duties of the department include a general supervision and control of the administration of the Poor Law, laws relating to public health, and numerous functions which fall to be performed by many local authorities. Its medical department includes a medical inspector and staff for general sanitary purposes, under it being the national vaccine establishment and the animal-vaccine lymph station. It inspects alkali-works and canal-beats. It has certain statutory powers as to bridges and highways. It watches over the actions of such local bodies as the board of guardians, the quarter sessions in counties, and the town council in burghs.

This is done by means of inspectors; and if the local body does not perform its duty, this board may take action, by ordering the removal of the nuisance, or make good the faulty proceedings of the inferior body. It has also certain powers of reapportionment of county councils, altering boundaries and transfer of powers from one body to another. By the Census Act of 1890 the Local Government Board was made the central superintending authority in England, and authorized to prescribe the necessary forms and instructions which are to be prepared and issued by the Registrar-General. See also ENGLAND, Vol. VIII, p. 252.

**LOCAL-OPTION LAWS.** See LIQUOR LAWS, Vol. XIV, p. 689; and LIQUOR LAWS IN THE UNITED STATES, in these Supplements.

**LOCH, LORD, RT. HON. HENRY BROUGHAM, G. C. M. G.,** British diplomat, late governor of Cape Colony and high commissioner for South Africa, was born May 23, 1827, and died June 20, 1900. In 1857, he was attached to the diplomatic mission to China under Lord Elgin, and as secretary to the embassy brought to England the treaties of Yeddo and Tien-tsin, and the convention of Peking. During the war in China, he was made prisoner and carried about in a cage by his captors to be exhibited to the natives. Afterwards liberated, he became secretary to Sir Geo. Grey, in 1861-63, English home secretary. He subsequently was governor of the Isle of Man, governor of Victoria, and governor of the Cape. Representing British interests in South Africa, he was a conspicuous figure during the Matabele War. He resigned the governorship of the Cape in 1895.

**LOCKE, DAVID ROSS,** an American humorist, better known as **PETROLEUM V. NASBY**; born at



DAVID R. LOCKE.

Vestal, Broome County, New York, Sept. 20, 1833. In his youth he learned the printer's trade. After being connected with several papers in Ohio, he became successively editor of the *Plymouth Advertiser*, the *Mansfield Herald*, the *Bucyrus Journal*, and the *Findlay Jeffersonian*. While editing the *Jeffersonian* he began, in 1860, to insert his "Nasby" letters, afterwards collected and published under the title *The Struggles—Social, Political and Financial—of Petroleum V. Nasby* (1872). In 1865 Locke became proprietor and editor of the *Toledo Blade*, in which he satirized President Johnson's method of reconstructing the Southern States. In 1871 he removed to New York and became managing editor of the *Evening Mail*, but he returned to Ohio after a few years. Mr. Locke published *Divers Views, Opinions and Prophecies of Yours Truly* (1865); *Swingin' Round the Circle* (1867); *Nasby in Exile* (1882); and many political, social and literary pamphlets. He died in Toledo, Ohio, Feb. 15, 1888.

**LOCKER-LAMPSON, FREDERICK,** an English writer of *vers de société*, was born in Greenwich in 1821. He was for many years a clerk in the English Admiralty Office. In 1850 he married a daughter of the Earl of Elgin, and in 1874, two years after her death, the only daughter of Sir Curtis Lampson, a wealthy London banker, when he added the surname Lampson to his own. He was a dilettante in his tastes, and a great collector of drawings by the old masters and of early editions of rare Elizabethan authors. In 1857 he published a collection of bright and clever poetical trifles, entitled *London Lyrics*. This gave its author a vogue in England with other clever society poets. A further collected volume, *Patchwork*, came from his pen in 1879; and in 1892 he published a revised and extended edition of *Lyra Elegantiarum*, an anthology of social verse, which he had edited originally in 1867. After his death at Rowfant, Sussex, May 30, 1895, an autobiography appeared, entitled *My Confidences: Addressed to My Descendants*. It is full of delightful cheerful reminiscence.

**LOCK HAVEN,** a city and the capital of Clinton County, central Pennsylvania, pleasantly situated in a mountain valley on the south bank of the west branch of the Susquehanna, 28 miles above Williamsport. It is on the Beech Creek and Pennsylvania railroads, and on the West Branch canal. Lock Haven does a large business in making and shipping pine lumber. It contains a state normal school, large foundries and tanneries, saw, paper and planing mills, machine-shops, and fire-brick, sewer-pipe and cigar factories. Population 1890, 7,358; 1900, 7,210.

**LOCKING-MECHANISMS FOR RAILWAY SWITCHES.** A useful electric locking-device has come into use in connection with the mechanical locks on numerous railway lines. It consists primarily of a pair of electromagnets secured in a strong cast-iron box attached in line with the lever to be locked, acting, when charged with an electric current, to hold the end of a short lever out of a notch in a locking-disk secured to the flop. While there are no trains in the vicinity, the electric lock remains inoperative, and does not interfere with the mechanical lock, but when a train approaches, and at a distance, say, of one mile, warns the switchman to adjust his levers for its passage. His reversing of a lever is made to shut off the electric current, demagnetizing the lock-magnet so that the short lever is dropped into place and the switches are locked so as to maintain the right of way for the coming train until the last pair of wheels on the last truck have passed the switches, when the current is restored automatically and the operator is again free to set the switches. The advantage of this is, that it obliges the operator, after having once given the right of way to a train, to leave things alone, and no nervousness or mischance on his part, or mischievousness on the part of others, can interfere with the maintenance of the right-of way thus reserved for the train.

Hydraulic systems of locking-switches have been objected to in cold climates, because of the liability of the water to freeze. This has been obviated

largely by mixing glycerine with the water, thus materially lowering the freezing-point. It is claimed that with a proper mixture the system can be operated successfully at a temperature 20° F. below zero. The system has the advantage, over mechanical connections of rods and levers, that it requires much less power to shift the levers, since an accumulator is stored with power to do the actual work, while the operator has only to set the levers, which are short and light, in proper position. Additional safety is provided for in the most recent of these locking systems, by a double motion, not practicable with mechanically operated locking-mechanisms. The first and partial movement of the switch-lever turns on the fluid to the switch, unlocks and moves it, then returns to the cabin and releases the lever, which can then be pulled the remainder of its stroke, releasing the signal-lever.

C. H. COCHRANE.

**LOCKJAW.** See **TETANUS**, Vol. XXIII, pp. 199, 200.

**LOCKLAND**, a village of Hamilton County, southwestern Ohio, 11 miles N. of Cincinnati, on the New York, Lake Erie and Western railroad. It has starch, flour, paper, lumber and asbestos mills, brickyards and cotton-goods factories. Population 1890, 2,474; 1900, 2,695.

**LOCKPORT**, a village of Will County, northeastern Illinois, 30 miles S.W. of Chicago, on the Chicago and Alton and the Atchison, Topeka and Santa Fé railroads, and on the Illinois and Michigan canal. It is in an agricultural and limestone-quarrying region, and has manufactories of flour, oatmeal, wire, strawboard, barbed wire and brass castings. Population 1890, 2,449; 1900, 2,659.

**LOCKPORT**, a city of northwestern New York, on the New York Central and Hudson River and the New York, Lake Erie and Western railroads. At present the principal manufactories are those of Holly water-works machinery, milling machinery, indurated fiber products, flour, steam-dredges, boilers, engines, railroad trucks, aluminium, glass, carriages, furniture, paper, pulley-blocks, saws, reversible seats, and stave, broom, veneer and chair making machinery. Population 1900, 16,581. See also **LOCKPORT**, Vol. XIV, p. 764.

**LOCKROY**, ÉDOUARD ÉTIENNE ANTOINE SIMON, a French journalist and politician; born in Paris, July 18, 1838. He studied art, graduated at the École des Beaux-Arts, and accompanied Renan on his archaeological expedition to Judea and Phœnicia. On his return he took part in Garibaldi's Sicilian expedition; published some articles in *Figaro* and other journals which caused his imprisonment for four months; was an original member of the National Assembly (1871); became editor of *Le Peuple Souverain*, and again got into trouble with the authorities; was imprisoned twice in 1872 for a duel, and in 1873 for newspaper articles; in the latter year was elected to the Council; in 1888 was Minister of Public Instruction; and in 1889 directed the organization of the exposition. He published *À bas le Progrès* (1870); *L'Île Révoltée* (1877); *Ahmed le Boucher* (1888); and *Journal d'une Bourgeoise Pendant la Révolution* (1881).

**LOCKWOOD**, BELVA ANN BENNETT, an American reformer; born in Royalston, New York, Oct. 24, 1830. She was educated at a district school, and taught at the age of 15. At the age of 18 she married Uriah H. McNall, who died in 1853; graduated at Syracuse University 1857; taught in New York; then moved to Washington, District of Columbia, where she opened a school and began to study law; in 1868 married Ezekiel Lockwood; was admitted to the bar in 1873, and to supreme court practice in 1879. She was an active advocate of woman suffrage, and in 1884 was nominated by the Equal Rights Party for the Presidency of the United States.

**LOCKWOOD**, SIR FRANK, an English lawyer; born in Doncaster in 1846, and educated at the University of Cambridge. He was called to the bar, at Lincoln's Inn, in 1872; appointed a queen's counsel in 1882, and a bencher of the society in 1884. He served as one of the royal commissioners to inquire into the corrupt practices at the Chester election in 1880; was appointed recorder of Sheffield in 1884; and was member of Parliament for York in 1885-95. He was concerned with Lord Russell of Killowen (then Sir Charles Russell) as counsel for the Irish party before the Parnell Commission, and for years occupied a leading position at the bar. His abilities as a wit and caricaturist were as marked as his legal acumen. In 1889 he illustrated C. J. Darling's facetious *Scintille Juris*, and in 1895 published *The Law and Lawyers of Pickwick*. In October, 1894, he was appointed Solicitor-General; was knighted in November, 1894; and in 1896 visited America in company with Lord Russell. Died in London, Dec. 19, 1897.

**LOCKYER**, SIR JOSEPH NORMAN, an English astronomer; born at Rugby, May 17, 1836. He was educated partly in Germany, and entered the British War Office in 1857. In 1860 he became a fellow of the Royal Astronomical Society, and in 1869 he was elected to the Royal Society. He was chief of the expedition sent to Sicily in 1870, to observe the solar eclipse, and of that to India in 1871. In 1874 he became editor of *Nature*. Lockyer's investigations were mainly in the field of solar physics and spectroscopic observations. He published *Elementary Lessons in Astronomy; Contributions to Solar Physics* (1873); *The Spectroscope* (1873); *Studies in Spectrum Analysis* (1878); *The Dawn of Astronomy* (1893); and *Star-Gazing, Past and Present* (1878). He was awarded the Janssen prize for astronomy by the Academy of Sciences in 1890, and was chosen editor of *Nature*. In 1897 he was made K. C. B.

**LOCOMOTIVE.** See **RAILWAY**, Vol. XX, pp. 245-255; and **RAILROADS**, in these Supplements. The locomotive-engine has changed very little, and that only in details of construction, since the times of Trevithick and Stephenson. The locomotive which won the victory at Rainhill, the *Rocket* and the *Planet* type, introduced by Stephenson in 1833, are the base-types of all that have succeeded them. The same form of boiler, the same valve-motion, the same system of producing draft, and in fact every essential element of the modern machine, may be found in the old engines of two generations ago, and in

very good form and proportions. The modifications which meantime have occurred have been mainly in the adaptation of the machine to heavy or to light, to fast or to slow, transportation, and by change of proportions of parts, rather than by change of fundamental construction. The only radical alteration of late years has been the application of the compound system (well known for a century, nearly, in other departments of steam-engineering) to the locomotive. The essential and peculiar requirements of the case come of the necessity of being able to stop and to start, and to reverse, the engine without delay or difficulty; and this has come to mean the provision of a system by means of which the engine may be handled precisely like the simple engine, and can, in fact, be converted from simple to compound, and the reverse, instantly as required. The engine is started as a simple machine, and, once fairly under way, is made to work as a compound. So effective are the devices now in use for this purpose, that the engine-driver has but to handle his reverse-lever and throttle precisely as with the older form, and the rest is accomplished automatically.

The modern locomotive, in the best form of compound machine, illustrates the most remarkable combination of tremendous power with concentrated volume and small weight that has yet been produced by the engineer, and in the latest form its economy is, all things considered, hardly less remarkable than its power and its concentration of energy into small weight and space. The form of the standard American engine is seen in the accompanying illustration.\*

connected to the crank-shaft, F, by the connecting-rod, G H the driving-wheels, I J the truck-wheels, carrying the truck, K L; M N is the fire-box, O O the tubes, of which but four are shown. The steam-pipe, R S, leads the steam to the valve-chest, T, in which is seen the valve, moved by the valve-gear, U V, and the link, W. The link is raised or depressed by a lever, X, moved from the cab. The safety-valve is seen at the top of the dome, at Y; and the spring-balance, by which the load is adjusted, is shown at Z. At *a* is the cone-shaped exhaust-pipe, by which a good draft is secured. The attachments *b, c, d, e, f, g*—whistle, steam-gauge, sand-box, ball, head-light and "cow-catcher"—are nearly all peculiar, either in construction or location, to the American locomotive. The locomotive is furnished with a tender, which carries its fuel and water.

The compound locomotive in its simplest form, that with two cylinders, the high-pressure on the one side, the low-pressure on the other, was probably first designed in 1834, by Röntgen, a Dutch engineer, whose specifications described a *machine à vapeur expansive à cylindres indépendants et combinés*. It is not known that the invention was actually brought into use. Mr. A. Mallet was probably the first to introduce these machines practically into regular work, building his first engines at Creusot for the Bayonne and Biarritz railway in 1875. Von Borries followed with his engines, in Germany, in 1880, and the compound locomotive has since then rapidly taken its place on all the great railways of the world.

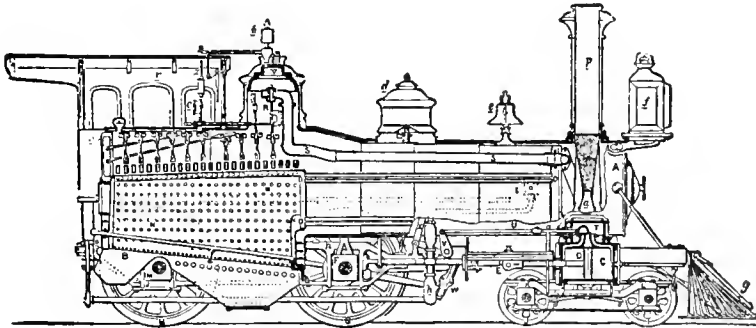

Fig. 1.—THE LOCOMOTIVE. Scale  $\frac{1}{100}$ .

The peculiarities of the American type (Fig. 1) are the truck, I J, or bogie, supporting the forward part of the engine, the system of equalizers, or beams, which distribute the weight of the machine equally over the several axles, and minor differences of detail. The cab, or house, *r*, protecting the engine-driver and fireman, is an American device, which is gradually coming into use abroad also. The American locomotive is distinguished by its flexibility and ease of action upon even roughly-laid roads. In the sketch, which shows a standard American engine in section, A B is the boiler, C one of the steam-cylinders, D the piston, E the cross-head, con-

Several thousands were in use in 1896, of which it is estimated one half were in England and Germany, and only about ten per cent in the United States, and about the same proportion in France.\*

The compound engine is finding its way into common use rapidly now, and exhibiting a gain over the simple engine of from 10 to 25 per cent in steam-consumption, and of 15 to 30 per cent in the demand for fuel, at full loads and steady speeds. It is, in some respects, found less perfectly adapted to varying loads and unfavorable conditions of operation, but it has its own special advantages in nearly all cases. The adoption of the "multiple-cylinder" system, the use of a

\* *Manual of the Steam-Engine*, Vol. 1, Fig. 95, p. 195. R. H. Thurston. New York: J. Wiley & Sons.

\* *Vide Borries on the Compound Locomotive*, Transactions of the American Society of Mechanical Engineers, 1893, No. DXXXVII.

pair of cylinders "in series," in place of a pair of cylinders "in parallel" as the electrician would perhaps designate it, an "*en cascade*" as French engineers denominate the arrangement, has the special advantage of reducing the internal wastes known as initial or cylinder condensation, which amounts to twenty and even to forty per cent, often, of the total supplied from the boiler, to about one half these figures. The restricted range of expansion in each cylinder, as compared with the larger ratio in the simple engine, makes the fraction of this steam condensed at entrance comparatively small; while the series arrangement permits the wastes of the high-pressure engine to be applied to satisfying the demand for excess of steam in the low-pressure cylinder for a similar waste there. The loss is thus that of restricted expansion in a single cylinder. With three cylinders, in series, as in many marine engines and in some experimental locomotives, the internal losses of this sort are thus reduced to one third their former, and very serious, amount. This reduction in the demand for steam permits larger proportion of heating-surface in the boiler, and thus a second and superadded economy there, which proves to be a very important quantity.

The special feature of the successful forms of compound locomotive, constituting their element of superiority, in the most usual type, is what is known as the "intercepting-valve." The simplest construction is evidently that which employs but two cylinders, and those arranged on either side the engine, as in usual practice, and only differing from the older form in the fact that one is a small, high-pressure cylinder, the other a comparatively large, low-pressure cylinder. The intercepting-valve is that contrivance which permits the action of direct steam in both cylinders at starting, precisely as in the simple engine, thus evading the otherwise fatal objection to the system that starting-power could not be insured to move the train from rest. With an intercepting-valve, or its equivalent, steam is permitted to enter both engines, as ordinarily, and the locomotive acts as a simple machine until fairly under way, when the operation of the valve,

sometimes by the hand of the engine-driver, sometimes automatically, changes the course of the steam, and it enters, first the high-pressure cylinder and thence passes into the low-pressure, stroke by stroke, and the machine is a compound engine so long as at speed. Reversal of the valve at stopping converts the machine into a simple engine, and handling at stopping and starting, and in reversing, becomes as easy and safe as with the older form. This is the one peculiar and characteristic feature of the compound locomotive. An illustrative example of this remarkable and ingenious contrivance follows.

The arrangement adopted by Mr. Pitkin is seen in the figures 2 and 3.

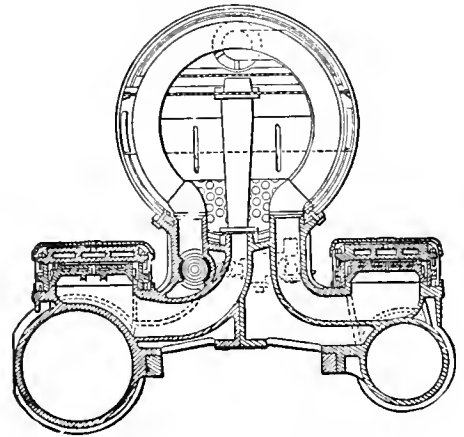

Fig. 2.—THE PITKIN COMPOUND.

It includes one high and one low pressure cylinder, with the intercepting-valve seen in the next illustration. The "receiver" between the two cylinders has a volume fifty per cent greater than that of the small cylinder. The valves are arranged and the general disposition of parts is as in the standard engine of the old form.

The intercepting-valve, as here seen in section, is as at the instant of starting, and before compound working begins, the ports *c* and *d* closed and no connection existing between the receiver and

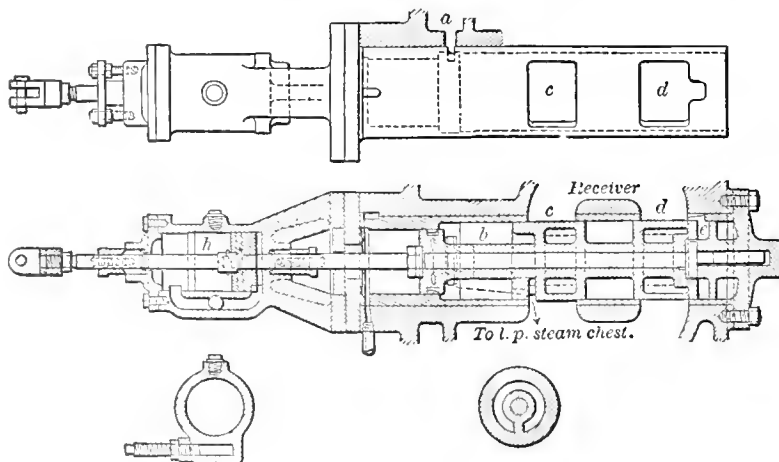

Fig. 3.—PITKIN'S INTERCEPTING-VALVE.

the large cylinder, while the latter receives steam through a reducing-valve and the port *a* and the passage *b*.

On starting, the exhaust from the small cylinder fills the receiver, and the back-pressure taking effect, through *c*, on the intercepting-valve and destroying its equilibrium, it at once moves over, and the large cylinder takes its steam properly for compound-working.

The dash-pot, *h*, prevents too sudden movement.

This engine has the following dimensions: Cylinders, diameter, 20 and 29 inches; stroke of piston, 24 inches; ratio of cylinders, 2.1; diameter drivers (6), 68 inches; weight of engine, 126,800 pounds; heating-surface, 1,677 square feet; grate-surface, 28.57 feet. About 80 per cent of the total weight is on the drivers.

There were, in 1896, about 170,000 miles of railway in the United States, valued at not less than \$10,000,000 with their equipments, employing a million or more men. The locomotive has arrived at such perfection as to be capable of drawing a heavy train on a good road at the rate, for a short distance, of 100 miles an hour, and, for distances of 400 and 500 miles, as from New York to Buffalo, or from London to Aberdeen, 50 to 55 miles an hour, with occasional spurts of 70 or even 80 miles. The "world's records" stood, January, 1896, thus:\*

ently strong probability of finding a permanent place, especially in Europe, where all roads are good, and in parts of the United States, where they are good, or at least are passable, at all seasons. This type of vehicle was remarkably successful for a time in Great Britain, especially in and near London, from 1827 to 1834, at one time about thirty being in steady work in and about that city. Some of these, as the carriages of Hancock, carried thousands of passengers, traveled thousands of miles, and held fixed routes for months together. The rise of the steam-railway, however, and the opposition of other interests, together with restrictive legislation, completely broke up this then promising business, and self-propelled carriages never have regained the place then held by them. Those now coming into use are propelled by steam, in larger numbers by electricity, and in still larger proportion by petroleum engines. Such engines have been found capable of traversing hundreds of miles of highway in France, with success and promptness, and without accident or danger.

These locomotives are now built in considerable numbers on both sides of the Atlantic, and those which have survived the test of actual work are claimed to be absolutely safe, to be free from noise, jar, heat and odor, to be easy of manipulation, and safe of control, powerful and economical, and not costly.

These machines are propelled very successfully by the electric current derived from a storage battery, where current is "on tap" at convenient points, and at moderate cost; and such vehicles—for example, that of Messrs. Morris and Salom of Philadelphia—have proved themselves exceedingly satisfactory. At the *Petit Journal* competition of 1895, 102 vehicles were entered, of which 23 were supplied with petroleum motors, 12 were driven by steam, 2 by compressed air, and 1 combined steam and petroleum as a working-fluid. Of these, 17 started in the race. A speed of 17 miles an hour was attained, and the route between Paris and Bordeaux, a distance of 725 miles, was traversed successfully in 22½ hours; while the time, out and back again, was 48 hours and 53 minutes. In the *Times-Herald* contest at Chicago in 1895, 6 vehicles entered, and the route of 54 miles' length was traversed by the victor in the race and 70 miles additional voluntarily added. Steam in this field has, at least at the moment, been distanced by petroleum and electric motors; but builders of either type are now ready to supply light, strong and swift self-moving carriages, and to meet any requirement as to character of work to be done by them.

R. H. THURSTON.

LOCOMOTIVE, ELECTRIC. See MOTORS, in these Supplements.

LOCY, WILLIAM A., an American zoölogist; born in Detroit, Michigan, Sept. 14, 1857. He was graduated at the University of Michigan in 1881; spent a year in graduate work in the department of biology in the same institution, and

	LAKE SHORE AND MICH. SOUTH. U. S.	N. Y. CENTRAL AND H. R. RAILROAD. U. S.	WEST COAST ROUTE. ENGLAND.
Date	Oct. 24, 1895.	Sept. 11, 1895	Aug. 22-23, '95
No. of cars	3	4	3
Weight of cars	304,500	358,310 lbs.	150,080
Starting-point	Chicago	New York	London
Finish	Buffalo Creek	East Buffalo	Aberdeen
Total distance in miles	510.1	436.32	539.75
Total time in minutes and seconds	481 m. 7 s.	411 m. 56 s.	512 m.
Average speed in miles per hour	63.614	63.55	63.25
Total time in motion	470 m. 20 s.	407 m. 41 s.	505 m.
Average speed, deducting stops	65.07	64.22	64.12
Length of division on which fastest average speed was made	86	145.6	141.25
Average speed on said division	72.92	65.75	67.50

DETAILS—L. S. & M. S.

1 mile was made at the rate of	92.3	miles per hour.
8 consecutive miles at the rate of	85.44	miles per hour.
33 consecutive miles at the rate of	80.6	miles per hour.
85 consecutive miles at the rate of	72.02	miles per hour.
181.5 consecutive miles (including stops)	68.67	miles per hour.
181.5 consecutive miles (deducting stops)	69.67	miles per hour.
289.3 consecutive miles (including stops)	65.14	miles per hour.
289.3 consecutive miles (deducting stops)	66.68	miles per hour.
422.7 consecutive miles (including stops)	64.45	miles per hour.
422.7 consecutive miles (deducting stops)	65.80	miles per hour.
510.1 consecutive miles (including stops)	63.614	miles per hour.
510.1 consecutive miles (deducting stops)	65.073	miles per hour.

The journey from New York to San Francisco has been made by a special train in 3 days 7 hours 49 minutes 16 seconds. The regular schedule time is now about four days.

Road-locomotives, steam-carriages, "automobile" vehicles, as they are variously called, and the lighter construction coming to be known as "motor-cycles," have recently been revived extensively, and are brought forward with appar-

\* *Science*, Dec. 13, 1895, p. 801.

a year in Harvard University, publishing, while there, a thesis containing the first printed account of the arthropod eye. He became professor of biology in Lake Forest College in 1887, and in 1891 was elected professor of physiology at Rush Medical College, in its medical department, retaining both chairs. By the authorities of Rush Medical College he was sent to Europe to purchase apparatus and inspect the laboratories of the Old World, and while in Germany carried on work under Du Bois-Reymond and Gad in the University of Berlin. On account of ill health he gave up his professorship at Rush Medical College in November, 1891. In January, 1896, he succeeded Dr. E. G. Conklin in the chair of zoölogy at Northwestern University. His contributions to the scientific periodicals of both Germany and America include *Primary Segmentation of the Vertebrate Brain*; *The Derivation of the Pincal Eye*; *On Teaching Zoölogy to College Classes*; and *The Optic Vesicle of Elasmobranchs*. Dr. Loey exercised editorial supervision in the department of general biology and zoölogy for these Supplements, and wrote for the same the articles on EMBRYOLOGY; HUXLEY'S SEGMENTATION OF THE VERTEBRATE HEAD AND BRAIN; and SENSE-ORGANS.

LODGE, HENRY CABOT, an American author; born in Boston, May 12, 1850. He graduated at Harvard College in 1871, and from the Law School in 1874; lectured, in the university, on American history (1876-79); edited the *North American Review* (1873-76) and the *International Review* (1879-81). He served two years in the state legislature; represented his district in Congress from 1886 to 1892; and was elected United States Senator in 1893. He wrote *Life and Letters of George Cabot* (1877); *Short History of English Colonies in America* (1881); *Life of Alexander Hamilton* (1882); *Life of Daniel Webster* (1883); *Studies in History* (1884); *Hero Tales from American History*, with Theodore Roosevelt (1895); *The Story of the Revolution* (1899); and edited *The Works of Alexander Hamilton* (1885). He was a delegate-at-large to the Republican national conventions in 1884 and 1896.

LODGE, OLIVER JOSEPH, an English physicist; born near Stoke-upon-Trent, Staffordshire, June 12, 1851. He finished his education at the University of London in 1877; became demonstrator, and in 1877 assistant professor, in physics at the University College, London; and after 1881 was professor of physics at the University College, Liverpool. He was a member of the Institute of Electrical Engineers and several physical societies of Liverpool and London. He did much work in the field of electrical induction and in clearing up the function of ether in propagation of electromagnetic and electrostatic disturbances. Among his publications are a text-book on *Mechanics* (1877), *Modern Views on Electricity* (1889); *Lighting-Guards*; *Pioneers of Science*; and *The Work of Hertz and Some of His Successors* (1894).

LÓDZ, a town in western Poland. It is almost exclusively engaged in the manufacture of cotton goods. The remarkable growth of the place is due to the prohibitive duties of Russia, which

compelled foreign traders to set up their mills within the Russian boundaries. Population 1897, 315,209. See also LODZ, Vol. XIV, p. 768.

LOESS, an alluvial deposit. See GEOLOGY, Vol. X, p. 367; and CHINA, Vol. V, p. 632.

LOGAN, a village and the capital of Harrison County, central western Iowa, 28 miles N. of Council Bluffs, on Boyer River, and on the Chicago and Northwestern railroad. It ships building-stone, black walnut lumber, stock and grain. Population 1900, 1,377.

LOGAN, a city and the capital of Hocking County, southern central Ohio, 51 miles E.N.E. of Columbus, on the Hocking canal, and on the Columbus, Hocking Valley and Toledo railroad. It is in a coal and iron mining region; has flour-mills, woolen, brick and furniture factories, a foundry, a blast-furnace and a large trade. Population 1890, 3,119; 1900, 3,480.

LOGAN, a city and the capital of Cache County, northern Utah, 70 miles N. of Salt Lake City, on Logan River, and on the Union Pacific railroad. It is the center of a fine wheat, stock and dairy region, and has a number of manufactories and excellent water-power. It has several educational institutions, among them Brigham Young College, New Jersey Academy and the Utah Agricultural College and Experiment Station, and Methodist and Episcopal academies. Population 1890, 4,565; 1900, 5,451.

LOGAN, FORT, a United States military post in the DEPARTMENT OF THE COLORADO, having a post-office, telegraph and railroad station of the same name; in Arapahoe County, northern central Colorado, 10 miles S. of Denver, on the Denver and Rio Grande and Union Pacific railroads. It is garrisoned by ten companies of troops, comprising both cavalry and infantry.

LOGAN, MOUNT, the highest peak in North America, situated in the British Northwest Territories, near the Alaskan boundary, about 26 miles N.N.E. of Mount St. Elias, in long. 60° 34' N., long. 140° 24' W. In 1892 the United States Coast and Geodetic Survey sent out J. H. Turner, who, by triangulation, found its height to be 19,514 feet, or over 1,000 feet higher than Mount St. Elias and Mount Orizaba, previously believed to be the highest peaks in North America.

LOGAN, GEORGE, an American public man; born at Stenton, Pennsylvania, Sept. 9, 1753. He studied medicine at Edinburgh, and then traveled a year on the Continent, returning in 1780. In 1798 he went to France, on his own responsibility, as a peacemaker between that country and his own, and succeeded in having the embargo on American shipping removed. On his return he was denounced by the Federalists, who secured the passage of a bill through Congress making it a high misdemeanor for a private citizen to take part in a controversy between the United States and a foreign power. Dr. Logan was in the United States Senate from 1801 to 1807, and went to England in 1810, on his own responsibility, to try and avert war, but was unsuccessful. He devoted much time to scientific agriculture, upon which



subject he wrote several papers. He died at Stenton, April 9, 1821.

LOGAN, JAMES, an American statesman; born at Lurgan, Ireland, Oct. 20, 1674. He lived in Ireland and then in England till 1699, when he went to the United States as William Penn's secretary. Soon afterward he became provincial secretary, commissioner of property, and receiver-general of Philadelphia, and from 1702 to 1747 was a member of the provincial council. In 1715 he was made a justice of the court of common pleas, and in 1723 presiding judge. The same year he became mayor of Philadelphia, and from 1731 to 1739 was chief justice of the supreme court. His latter years, spent in retirement, were devoted to science and literature, especially the classics, and he was a member of the first board of trustees of what is now the University of Pennsylvania. He died at Stenton, Pennsylvania, Oct. 31, 1751.

LOGAN, JOHN, an Indian chief; born about 1725. He came of the Cayuga tribe, and was called Tah-gah-jute, his English name being adopted in honor of James Logan, the friend of the Indians, and secretary to William Penn. Logan dwelt near the Moravian settlement at Shamokin Creek, on friendly terms with his neighbors. Later he lived near Reedsville, Pennsylvania, where he was chosen chief of the Mingo tribe, and in 1770 retired to the banks of the Ohio River. In 1774 his entire family was massacred by settlers on the Ohio River. Logan suspected that the deed was done at the instigation of Michael Cresap, and during several months his tribe perpetrated many barbarities on the whites, he personally taking thirty scalps. The Indians were defeated near the Great Kanawha River. At that time he would not appear among those who sued for peace, but instead led the emissary of Governor Dinsmore into the woods and told the story of his wrongs, made famous by Jefferson in his *Notes on Virginia*. In his declining years Logan became a drunkard and killed his wife. He was killed at Detroit in 1780, by a party of Indians whom he had attacked while intoxicated.

LOGAN, JOHN ALEXANDER, an American soldier and statesman; born in Jackson County,

Illinois, Feb. 9, 1826. At the beginning of the Mexican War, though but twenty years of age, he at once enlisted and became a lieutenant in an Illinois regiment. He returned home with an excellent military record, and commenced the study of law. In 1849 he became clerk of Jackson County, and at the expiration

of his term went to Louisville, Kentucky, where he was admitted to the bar in 1851. In the fall of the same year he was elected to represent Jackson and Franklin counties in the legisla-

ture, and from that time was almost uninterruptedly in the public service, either civil or military. He was twice re-elected to the legislature, and in 1854 was a Democratic Presidential elector. On the outbreak of the Civil War he resigned his seat in Congress, enlisted in the Union Army, and rose to the rank of major-general. After the war he served two terms in Congress; from 1871 to his death he was a United States Senator from Illinois; and in 1884 was nominated for the Vice-Presidency on the ticket headed by James G. Blaine. General Logan wrote *The Great Conspiracy* (1886), and *The Volunteer Soldier of America*, published in 1887, after his death. He died in Washington, District of Columbia, Dec. 26, 1886.

LOGAN, MAJOR JOHN A., son of the above, was born in Illinois, July 24, 1865, and for some time was a student at West Point. During the Harrison administration he held a consular appointment abroad, and when the war with Spain broke out he served on the staff in Cuba, under General Bates. He also acted for a time as assist.-adjut.-general, with the rank of lieutenant. For gallant conduct at El Caney he was promoted to the rank of major. On returning from Cuba, he was ordered to Manila with his regiment (the 33rd Infantry) and arrived there Oct. 27, 1899. While in action against the Philippine insurgents at San Jacinto, Nov. 12, 1899, he was shot by a Filipino sharpshooter.

LOGAN, SIR WM. E., a Canadian geologist, born at Montreal, April 20, 1798, and died in Wales Eng., June 22, 1875. Was for many years director of the geological survey of Canada.

LOGANIACEÆ, a family of dicotyledonous plants represented in the United States by the genera *Gelsemium* (yellow jessamine), *Polypleurum*, *Spigelia* (pink-root), and *Metreola*. They may be herbs, shrubs, or trees, whose entire and opposite leaves are connected by an interpetiolar sheath. The 4 to 5 parted perfect flowers occur in terminal or axillary cymes, the stamens are inserted on the corolla-tube, and the ovary is inferior. There are, in all, about thirty genera and more than 350 species, mostly native to the tropics. *Logania*, the typical genus, is an Australian form. Many highly poisonous plants are contained in this family; for example *Strychnos nux-vomica*, the poison-nut. Curare, strychnine and other alkaloids of medicinal importance are obtained from members of the family.

LOGANSPOUT, a city and the capital of Cass County, northern central Indiana. The city has a normal school, a state asylum for the insane, a public park, water, natural and manufactured gas, electric light-works and an electric street-railway. It carries on the manufacture of flour, lumber, castings, etc., and is the seat of extensive railroad-shops. Its trade with the surrounding country is considerable. It is the seat of a Universalist College. Population 1,000, 16.-204. See also LOGANSPOUT, Vol. XIV, p. 772.

LOGOS, THE. See CHRISTOLOGY, in these Supplements.

LOGGERHEAD-TURTLE. See TORTOISE, Vol. XXIII, p. 458.



GENERAL LOGAN.

LOGGIA, an Italian word signifying an open arcade inclosing a passage or open apartment. It is a favorite class of building in Italy and other warm countries. The Loggia dei Lanzi at Florence, begun by Orcagna in 1376, is one of the finest examples. See ORCAGNA, Vol. XVII, p. 815.

LOGOGRAPHERS. See RHETORIC, Vol. XX, p. 599.

LÖHER, FRANZ VON, a German historian; born at Paderborn, Westphalia, Oct. 15, 1818. He studied at the Halle, Munich, Freiburg and Berlin; traveled extensively in Europe, Canada and the United States in 1846-47; took part in the political movements of 1848, and was imprisoned by the Prussian government; was acquitted in a short time; was professor at Göttingen until 1855, when he went to Munich as professor and secretary of the academy. He founded the *Westphalia Zeitung* in 1848, and became known as the author of *Das System des Preussischen Landrechts* (1852); *Fürsten und Städte zur Zeit der Hohenstaufen* (1846); *Land und Leute in der Alten und Neuen Welt* (1857-58); *Jakobea von Baiern* (1861); *Neapel und Sicilien* (1864); *Griech. Küstenfahrten* (1876); *Russlands Werden und Wollen* (1881); and *Kulturgeschichte der Deutschen im Mittelalter* (1891). He died March 2, 1892.

LOKI, a deity. See ÆSIR, Vol. I, p. 210.

LOLIGINIDÆ, a family of cephalopod mollusks, represented on our coasts only by the typical genus *Loligo*. The body is conical, tapers posteriorly, and the fins are large. The family is composed of four living genera.

LOLLAND. See LAALAND, in these Supplements.

LOMBARDO, PIETRO, an Italian architect; born near Lugano, about 1438. He founded a school of architecture, which predominated in Venice until the Palladin style came into vogue. In 1499 he became architect-in-chief of the ducal palace, and directed the architectural work of the republic for 12 years. Among his famous works are the *Monument to Dante*; *Scuola di San Marco*; his masterpiece, the *Church of Santa Maria dei Miracoli*; and a great many smaller works. He died, probably at Venice, about 1511.

LOMBARD UNIVERSITY, a co-educational institution situated at Galesburg, Illinois. It was founded by the Universalists in 1851, and offers three courses, classical, scientific and literary. It also has a preparatory department, and the Ryder Divinity School is connected with it. Besides a large campus and equipments, the university owns property worth \$200,000, which yields an income of \$15,000. The attendance averages about 150; in 1895 there were 18 instructors, and the library contained 7,000 volumes.

LOMBARDY. See ITALY, Vol. XIII, pp. 441, 448, 469 et seq.

LOMBROSO, CESARE, an Italian criminologist; born in Venice, November, 1836. He was educated at the University of Turin; became professor of diseases of the mind in the University of Pavia (1862); was director of a hospital for the insane at Pesaro,

and then professor of medical law and psychiatry in Turin. He held that criminality is fatalistic, and derived through inheritance or climatic environment. He wrote *Epileptic Insanity* (1863); *Psychiatrico-Legal Investigations by Experimental Methods* (1867); *Anthropometry of Four Hundred Criminals* (1872); *The Criminal: An Anthropological and Medico-Legal Study* (1875); *The Man of Genius* (1891); and *Female Offenders* (1895).

LOMNICKY, SIMON. See SLAVS, Vol. XXII, p. 152.

LOMOND, LOCH, a lake of Scotland. See DUM-BARTON, Vol. VII, p. 524.

LONDON. Thomas Hughes once, in a lecture, expressed his judgment of the London problem by stating that it was the effort of 5,000,000 people to live together,—an effort which, he trusted, would never again be repeated. To a stranger it is perplexing to know just what London is. The name has various legal meanings; as, the City of London, including Southwark, which covers thirty acres more than one square mile, and, while having a night population of only 37,700, is frequented by day by 301,000 persons. There is another London for registration purposes, a third under the County Council, and still another constructed into boroughs for Parliamentary representation. Outside of this zone lie suburbs, which include nearly six times the area of the London under the County Council.

In 1891 these areas were returned as follows:

	ACRES.	DWELLINGS.	POPULAT'N.
Registration, London.....	74,672	544,977	4,211,743
County Council, London..	75,442	548,315	4,282,118
Parliamentary London....	80,148	580,381	4,437,021
Greater London.....	443,421	789,408	5,633,806

It will be seen that the first three of these systems differ but slightly in area, houses and population. They include the city, although it has its own organization and peculiar system of government. An account of the whole region, its his-



THE HOUSES OF PARLIAMENT.

tory and its great works is given under LONDON, Vol. XIV, pp. 818-851.

Since that article was published the government of the metropolis has been changed, the Metropolitan Board of Works having been superseded by the County Council, with larger powers. This Council was established by act of Parliament in 1888, and it went into operation in the follow-

ing year. The old board comprised forty-five members, who represented thirty-eight vestries and district boards. The Council consists of 118 elected councilors, who serve for three years, and 19 aldermen, having each a six-years' term, representing 196 civil parishes, co-extensive with thirty poor-law unions. In it the city is represented by four members, but not at the cost of a surrender of any of its liberties or autonomy. The jurisdiction of the Council extends to four dioceses, and is exercised in parts of the three counties of Middlesex, Surrey and Kent. It has no control over the police, which is under the Secretary of State for Home Affairs, and has Greater London for its field of operations.

In the selection of councilors, since 1891 women householders and peers may vote, but no elector can legally vote more than once in the county. The chairman of the Council is elected annually, and is, *ex officio*, a justice of the peace. The aldermen are chosen by the Council.

Plans for the unification of London were proposed to Parliament by a Royal Commission in 1894, under which the whole administrative county and the old city should be merged in a new corporation, to be known as the Mayor and Commonalty and Citizens of London; the city livery companies to be transferred to some department of the imperial government. The Progressives of the Council favor such an amalgamation, but the city authorities resist it, and no action has been taken by Parliament to effect such a union. Within the Council two parties have arisen, of nearly equal strength—the Moderates, or Conservatives, who would restrict the functions of the Council to necessary administrative work; and the Progressives, who are accused of socialistic tendencies, and whose policy, as put forward in 1895, include the municipal ownership of the public markets, of the gas and water supply, of the docks, and the river Thames improvements; the management of the street-railways for public profit; the erection, by authority of the council, of artisans' dwellings and lodging-houses; reform of the poor-law; a sequestration of a considerable part of the income of the city companies for public uses; compensation to tenants for improvements; taxation of ground values; and improved registration.

So vast and complex are the interests involved, that it is by no means an easy task to find an acceptable method of administration. Very few are the dwellers in London who have a freehold in their dwellings. Ground is occupied through lease upon lease, with the consequence that tenants care little for their residences, are migratory, and the crowding is excessive. The official definition of overcrowding is two persons to one room, and this is the condition of one third of the population in East London. Something has been done to improve artisans' dwellings by the County Council, and street after street may be found, in Marylebone and the East, built on monotonous model under official plans. Marked inroads have been made upon the squalor and dense-

ness of tenement districts by means of these civic improvements, and of the Peabody and Waterlow foundations, but the almost universal registration tenure in London of improvers and occupants, is paralyzing to reforms in this direction. For these reasons, London, with all its wealth and resources, and with enormous expenditures on public works, is not picturesque. The West End, where wealth is centered, the river embankments, the centers of trade, have their massive buildings, green-swards, noble monuments and parks, but they are belted with narrow streets and uniform houses not pleasing to contemplate.

The water system is still under the control of eight companies, drawing their supply from the Thames and the Lea. The difficulty of making an acceptable appraisalment has hindered the County Council from acquiring these properties, but a persistent movement is on foot to do so. The system is inadequate, although the supply equals thirty-five gallons *per capita*, and projects are contemplated for drawing a new supply from Wales at an outlay of \$150,000,000. The Council has under its control the care of the insane, the purification of the Thames, parks and open spaces, weights and measures, artisan house-building, public amusements, and public works. The London School Board is a separate organization. The estimated expenses of the County Council for the year ending March 31, 1896, were \$17,961,497 for maintenance, \$37,878,885 for capital account, of which \$24,000,000 were for loans to local authorities. Its consolidated stock in 1895 was returned at \$162,866,560. During the history of the County Council the parks and open spaces have increased from 2,656 to 3,684 acres, and 2,000,000 tons of sludge has been annually removed from the Thames.

It is worthy of note that the entire cost of the administration of municipal matters did not exceed 15 pence in the pound for the county outside the city, and 12½ pence for the city. Among the breathing-spaces recently opened to the teeming millions of the metropolis may be mentioned Whitfield Gardens in Tottenham Court Road, formerly part of an old burial-ground; Lincoln's Inn Fields in the heart of the lawyers' world, which was acquired at a cost of \$60,000; and Telegraph Hill, Hatcham.

The metropolis comprises the following Parliamentary boroughs, each returning the number of members that appears in parenthesis after its name: Battersea (1), Clapham (1), Bethnal Green (2), Camberwell (3), Chelsea (1), Deptford (1), Finsbury (3), Fulham (1), Greenwich (1), Hackney (3), Hammersmith (1), Islington (4), Kensington (2), Lambeth (4), London City (2), London University (1), Marylebone (2), Newington (2), Paddington (2), St. George's, Hanover Square (1), St. Pancras (4), Shoreditch (2), Southwark (3), Strand (1), Tower Hamlets (7), Wandsworth (1), West Ham (2), Westminster (1).

London's main thoroughfares run, like the river, from west to east. One continuous road extends from Shepherd's Bush, through Bays-

water, Oxford Street, Holborn, Cheapside, White-chapel and Mile End Road to Stratford-le-Bow, a distance of twelve miles. Nearly parallel to it, but joining it at Cheapside, is the great thoroughfare from Hammersmith and Kensington, receiving tributary streams of traffic from Fulham, Brompton and Chelsea, and running, by Hyde Park, through Piccadilly, the Strand, Fleet Street and Ludgate Hill.

The longest continuous line of streets from north to south is one of ten miles, from Stamford Hill, by the Kingsland Road and Bishopsgate Street, across London Bridge, by the Borough and Clapham roads to Balham. Some of the streets in the older part of the town, in Spitalfields, Clerkenwell and Holborn, were narrow, mean, straggling and irregular, but many improvements have changed, and are changing, this part. The Strand, Fleet Street and Cheapside are the thoroughfares where the traffic becomes most congested. Some main thoroughfares (such as the Marylebone Road), which have heavy traffic, are very badly lighted, so that the pedestrian, on a dark night, encounters no small risk to life and limb when crossing them. Other roads, particularly those in the west and southwest districts,—Mayfair, Tyburnia, Kensington, and Belgravia,—are spacious, regular and stately.

The Tower Bridge was opened in 1894. It was built by the corporation of the city at a cost of \$4,250,000, and is on the bascule principle, each leaf of the opening span being 100 feet long by 50 feet wide. The total length of the bridge and its approaches is 2,640 feet.

New electrical railways were begun in 1895; one, consisting of two tunnels, from Liverpool Street to Shepherd's Bush, 6½ miles, and connecting with other electric lines at Bank Station; another starting from the Mansion-House, passing by a tunnel near Blackfriars Bridge under the Thames, and extending to Waterloo Station on the Surrey side.



THE MANSION-HOUSE.

*Schools, Museums, Etc.* On March 25, 1895, there were, besides upward of 700 endowed schools and collegiate institutions, "board" schools with accommodation for 469,167 children, and accommodations for 44,905 more were in course of construction, and numerous "voluntary" schools with accommodation for 255,936

pupils. The School Board is composed of 56 members. Westminster (the old foundation public school of St. Peter's), St. Paul's (removed to West Kensington), Merchant Taylors', and the City of London schools and Christ's Hospital, are historically famous; also, University College School, King's College School, and others.

*Places of Amusement.* The finest concert-rooms are at St. James's and Queen's halls. The first is splendidly decorated, and used for classical and orchestral concerts. There are, also, Steinway and St. George's Halls and Portman Rooms. At the Exeter Hall (which holds 4,000 people), the "May meetings" are held, and it is the headquarters of the Young Men's Christian Association. It is also used for religious meetings. The Royal Albert Hall, Kensington, holds 10,000 people. There are sixty theaters, music-halls, etc., and others are either in course of erection or projected. At the Royal Italian Opera, Covent Garden, operas are produced during the season, while a magnificent "English Opera House," now called the Palace Theatre of Varieties, in Shaftesbury Avenue, was opened Jan. 31, 1891, with Sir Arthur Sullivan's *Ivanhoe*. Drury Lane is now used chiefly for spectacular pieces. The Vaudeville, Toole's, Terry's, Globe, Criterion, Opera Comique, Comedy, Garrick and Court, are among the best comedy theaters. Melodrama has its home at the Adelphi, Princess and Olympic; farce and burlesque at the Strand and Gaiety; opera bouffe at the Savoy, Prince of Wales and Lyric. The Haymarket and St. James's have been chiefly distinguished by the production of modern, social and historical dramas, while the Lyceum has seen the revival of Shakespeare's plays and the blending of realism and romanticism under the management of Sir Henry Irving. There are also many handsome singing-saloons, or "music-halls," and some of the most wonderful spectacular effects of the age have been produced at Olympia and the exhibitions at Earl's Court.

*Courts of Law, Prisons, Cemeteries.* The courts of law, which give employment to about 3,000 barristers and 5,000 solicitors, formerly scattered in Westminster, Lincoln's Inn and the city, were all united in 1882 in the magnificent Royal Courts of Justice, in the Strand. Solicitors' chambers are chiefly about Lincoln's Inn Fields, and those of barristers in the Inns of Court, which comprise the Middle and Inner Temples, and Gray's and Lincoln's Inn. There are sixteen police courts throughout the metropolis (including two in the city), and the police force in 1895 consisted of 32 superintendents, 595 inspectors, 1,869 sergeants, and 12,785 constables, with 324 horses; while the city force consisted of 133 officers and 795 constables, with 86 constables of private-service duty.

*Fire Brigade.* In London, up to 1825, almost the whole of the fire-engines were under the control of the insurance companies. The present fire brigade was placed under the control of the Metropolitan Board of Works in 1865, and received

support from the rates, the treasury, and the insurance companies. The rate was  $\frac{1}{2}$ d in the pound on the annual value of property ratable to the relief of the poor in the metropolis. In 1889 the brigade comprised 591 men and 55 land-engine stations, besides four floating-steamers. In 1889-90 the brigade was greatly strengthened and increased. It is now under the control of the County Council.

The officers and men number 741; there are, besides, 17 pilots, 75 coachmen and 137 horses. The *matériel* consists of 57 land-stations, 4 floating-stations, 52 hose-cart stations, 181 fire-escape stations, 9 steam fire-engines (barges), 50 land steam fire-engines; 95 engines worked by hand, besides 8 steam-tugs, 13 barges, 12 skiffs, 221 fire-escapes, 9 ladders (extra length), 9 ladder-vans, 2 ladder-trucks, 105 hose-carts and hose-reels, and 34 miles of hose, etc. The area that is so protected is 118 square miles, including the city and county of London, and extends from Roehampton to Plumstead, and from Sydenham to Highgate. The stations are connected by telephone with each other and with police-stations, public buildings and fire-alarm street-instruments. The annual cost is about \$650,000. The number of fires in 1894 was estimated at 3,410, and of these 180 resulted in serious damage.

*Trade, Commerce, Etc.* In 1895, 225 public and private banks had their head offices in London. The magnitude of their transactions may be estimated from the yearly returns of the clearing-house, through which, in 1894, exchanges were made amounting to \$31,685,000,000. There are some 1,250 stock-brokers, 90 head life assurance offices and about as many fire-offices.

For the conveyance of the inhabitants, besides private carriages, over fifteen thousand cabs and two thousand omnibuses are used. Hundreds of little steamers ply on the river. There are 16 great stations of the leading railway lines and over 200 minor stations. The underground lines of the Metropolitan and District railways form a complete circle to the center of the metropolis. Numerous tramway lines extend toward the suburbs in all directions. New electric and subway lines have been built, one of which, constructed in 1896, involves a tunnel under the Thames at Blackfriars Bridge.

The shipping of the port of London is enormous, over 54,500 ships, with a total tonnage of over 14,000,000 tons, entering and clearing annually. The exports are about \$383,500,000, or more than one fourth of those of the United Kingdom. The customs duties exceed fifty million dollars, being one half of the total of the United Kingdom, and more than three times greater than those of Liverpool. The value of the merchandise stored in London has been estimated to exceed two billion five hundred million dollars. The current prices of many commodities are cheaper than in other towns, but the luxurious ideas of a wealthy community render London a most expensive place of residence for the upper classes who court society. House-rents and the propor-

tionate taxes are exceptionally high. The healthfulness of London—its death rate (19.5 per 1,000) being less than in most of the large towns in Europe or in America—is partly due to favorable conditions of climate and situation, but also, in great measure, to its admirable sanitary arrangements. Twenty companies supply about twenty-eight million cubic feet of gas *per diem*. Several of the principal thoroughfares and many of the public and private buildings are now lighted by electricity. The town is well paved, and the wooden and asphalt pavements, now so general, have greatly lessened the noise in the streets.

LONDON, a city of Ontario, Canada. The later additions to the city are Huron College, a mercantile college, and insane and orphan asylums, hospitals and several libraries and manufactories. Population 1891, 22,281. The suburbs of East London and West London, and others not returned within the city limits, aggregate about 16,500. See also LONDON, Vol. XIV, pp. 851, 852.

LONDON, a village and the capital of Laurel County, southeastern central Kentucky, 68 miles S. of Lexington, on the Louisville and Nashville railroad. It has flour, planing and saw mills, and coal is mined. A ladies' seminary is situated here. Population 1900, 1,147.

LONDON, a city and the capital of Madison County, western central Ohio, situated 25 miles W. of Columbus, on the Cleveland, Cincinnati, Chicago and St. Louis and the Pittsburg, Cincinnati, Chicago and St. Louis railroads. It is in a rich agricultural region, and has large shipments of wheat, poultry and eggs. It is noted for its monthly stock sales. Population 1890, 3,313; 1900, 3,511.

LONDON, UNIVERSITY OF. See UNIVERSITIES, Vol. XXIII, p. 854.

LONDONDERRY, CHARLES WILLIAM STEWART VANE, MARQUIS OF, the third of the title, a British soldier and statesman; born in Dublin, Ireland, May 18, 1778. He served during the Napoleonic wars, both as a soldier and diplomat, and received a vote of thanks from Parliament; was with Abercrombie in Egypt; rose to the rank of adjutant-general to Wellington (1809); ambassador to Berlin (1813); to Austria (1814); and a member of the Congress of Vienna (1815). He died in London, March 6, 1854.

LONG, CHARLES CHAILLÉ, an American soldier and diplomat; born in Princess Anne, Maryland, July 2, 1842; enlisted in the volunteer service in 1862, and rose to the rank of captain. He became attached to the Egyptian army, and in 1874 was assigned as chief of staff to General Gordon; led two expeditions up the Nile, on the first of which, accompanied by only two soldiers and his servants, he secured a treaty from King M'Tsi acknowledging himself a vassal of Egypt. In September, 1877, he resigned and returned to New York, but in 1882 again went to Egypt, where he practiced law in Alexandria. During the massacres in that city at the time of Arabi Pasha's insurrection (1882), Colonel Long reestablished the American consulate and protected the refugees. He afterward removed to Paris, and in 1887 became United States consul-

general in Korea. He published *Naked Truths of Naked People* (1877); *The Three Prophets: Chinese Gordon, the Madhi, and Arabi Pasha* (1884).

LONG, JOHN DAVIS, American lawyer and public man; born in Buckfield, Maine, Oct. 27, 1838; graduated at Harvard in 1857, studied at the Harvard Law School, and was admitted to the bar in 1861. Entering politics he was elected to the Massachusetts Legislature, and reelected and made speaker of the House three successive years. In 1879 he was elected Lieutenant-Governor, and then Governor of Massachusetts for three consecutive terms. In 1883-89 he was member of Congress, and was a candidate for the United States Senate. On being defeated by Mr. Dawes he resumed the practice of his profession, and did not again hold office till appointed Secretary of the Navy in 1897.

LONG, STEPHEN HARRIMAN, an American engineer; born in Hopkinson, New Hampshire, Dec. 30, 1784. In 1814 he entered the United States army as a lieutenant in the corps of engineers; was assistant professor of mathematics at the United States Military Academy till 1816; was transferred to the topographical engineers; 1818 to 1823 had charge of explorations between the Mississippi River and the Rocky Mountains; and in 1823-24, of the sources of the Mississippi, receiving the brevet of lieutenant-colonel. From 1827 to 1838 he was engaged in railroad engineering, and then became major of the topographical engineers. While engaged in railroad-building he introduced a new kind of truss-bridge, which was called by his name and has been generally adopted in the United States. In 1861 he was made chief, with the rank of colonel, and in 1863 he was retired from active service. One of the highest peaks in the Rocky Mountains is named after him. He died Sept. 4, 1864.

LONGAN (*Nephelium Longan*), a fruit of the same genus as the Japanese *Litchi*, but reckoned superior to it.

LONG BRANCH, a town and fashionable summer resort of New Jersey. There is a life-saving station here, and the whole town, spread along the beach for nearly five miles, and also its suburbs, are well connected by rail and trolley. Permanent population 1890, 7,231; 1900, 8,872. Its summer population has been known to exceed 30,000. See also LONG BRANCH, Vol. XIV, p. 857.

LONGFELLOW, SAMUEL, an American clergyman, brother of Henry Wadsworth Longfellow; born at Portland, Maine, June 18, 1819. In 1846 he graduated at the Harvard Divinity School, and in 1848 was called to a church at Fall River. In 1853 he became pastor of a Unitarian church in Brooklyn, New York, but resigned in 1860, continuing to preach without pastoral charge until 1878, when he became minister of a church in Germantown, Pennsylvania. He published, among other works, *A Book of Hymns and Tunes* (1859); *Life of Henry Wadsworth Longfellow* (1886); *Final Memorials, etc.* (1887); *Thalatta: A Book for the Seaside*; and *Lectures, Essays and Sermons of Samuel Johnson*, (1883). He died in Portland, Oct. 3, 1892.

LONGIPENNES, an order or suborder of car-

inate, swimming birds, including the gulls, terns, albatrosses and petrels, its members being remarkable for long and narrow wings and great powers of flight. They are not naturally divers, though of pelagic habits. The present division of the group is into the *Gavia*, gulls and terns, and *Tubinares*, albatrosses and petrels.

LONG ISLAND. See HEBRIDES, Vol. XI, p. 607.

LONG ISLAND CITY, a city of New York, separated from Brooklyn by Newton Creek, but now part of Greater New York. It is the terminus of the Long Island and the Flushing and North Side railroad. It has large oil-refineries, sulphuric-acid factories, and many other large and important manufacturing establishments. Blissville, now incorporated within the city limits, on Newtown Creek, is the seat of large distilleries, and of factories for compressed yeast, fertilizers, etc. Astoria, the northwestern portion of Long Island City, contains carpet and piano factories, and many good residences. The part of the city called Ravenswood contains also many handsome residences. Long Island City has an extensive front along the East River, Newtown Creek and Long Island Sound, Newtown Creek being navigable at this point. The city has water-works, gas and electric-light plants and street-railways. The public schools have an enrollment of over six thousand pupils. Both Jamaica and Long Island City claim to be the county capital, each having several county buildings. Population of the city 1890, 30,506. See also LONG ISLAND CITY, Vol. XIV, p. 866.

LONG ISLAND SOUND. See LONG ISLAND, Vol. XIV, p. 865.

LONGITUDE AND LATITUDE. See GEOGRAPHY, Vol. X, p. 198.

LONGMONT, a town of Boulder County, northern central Colorado, 30 miles N. of Denver, on the Burlington and Missouri River and the Union Pacific railroads, and on Vrain Creek. It is in a fertile agricultural region, where some gold and lignite are found. Flour and canned goods are manufactured. It is supplied with city water, electric lights, a public library and free reading-room, common schools and an academy. Population 1890, 1,543; 1900, 2,201.

LONG PARLIAMENT. See CROMWELL, Vol. VI, pp. 599-602; and CHARLES I, Vol. V, pp. 404-407.

LONG PRAIRIE, a village and the capital of Todd County, central Minnesota, 24 miles W. of Little Falls. It is situated on Long Prairie River, in a fertile plain studded with beautiful little lakes. It is the seat of a seminary, and has several mills. Population 1900, 1,385.

LONGSTREET, AUGUSTUS BALDWIN, an American author; born in Augusta, Georgia, Sept. 22, 1790. In 1815 he was admitted to the Georgia bar; in 1821 he was a member of the legislature, and in 1822 became judge of the Ocmulgee judicial district. In 1838 he became a minister in the Methodist Episcopal Church, and was stationed at Augusta. From 1839 to 1848 he was president of Emory College, Oxford, Georgia; then became president of Centenary College, Louisiana; for six years, of the

University of Mississippi; from 1857 to 1861, of South Carolina College; and then again of the University of Mississippi. He contributed extensively to periodical literature, and was the author of *Georgia Scenery, Characters, Incidents, etc., in the First Half-Century of the Republic, by a Native Georgian* (1840), and *Master William Mitten* (1864). He died at Oxford, Mississippi, Sept. 9, 1870.

LONGSTREET, JAMES, an American soldier; born in Edgefield district, South Carolina, Jan. 8, 1821. He graduated at the Military Academy at West Point in 1842, and was on duty on the Mexican frontier till 1846; took part in the Mexican War (1846-48), where he was wounded; served as paymaster in the United States army, being promoted major on the staff in 1858. He resigned his commission to take part with the South in the Civil War; was present at the battle



GENERAL LONGSTREET.

of Bull Run. During the early part of 1862 he was made major-general, and won reputation, under General Lee, in the campaigns against McClellan, Pope, Burnside and Meade. After the battle of Fredericksburg, Longstreet was promoted to the command of a corps, with the rank of lieutenant-general. He took an active part in the battle of Gettysburg, and in the campaign of the Wilderness was wounded severely, but recovered in time to take command of his corps during the siege of Petersburg. He surrendered with General Lee in April, 1865. After the war General Longstreet acted zealously for the restoration of harmony between the two sections. He made New Orleans his residence, and, having been amnestied by President Johnson, he was so cordial toward the administration that President Grant appointed him surveyor of the port of New Orleans, after which he served four years as commissioner of engineers for Louisiana, and in 1880 was sent as minister to Turkey, where he remained until 1881. He was subsequently United States marshal for the northern district of Georgia, and was appointed commissioner of railroads by President McKinley in 1897.

LONGSTREET, WILLIAM, an American inventor; born in New Jersey about 1760. He removed to Georgia during boyhood; in 1790 appealed to the governor and legislature of Georgia for funds with which to construct a vessel, which was to be propelled by steam. He failed in securing these, but several years afterward secured funds from private sources and built a boat, which was launched and ran up the Savannah River, against the current, with the speed of five miles an hour. This was a few days after Fulton's experiment on the Hudson. He also invented the breast roller of cotton-gins. Died in Georgia in 1814.

LONGTON, a municipal borough and market town in Staffordshire, Eng., 2 miles S.E. of Stoke-upon-Trent; is one of the chief pottery towns, and

has blast furnaces, and coal and iron mines. Pop. 1891, 34,327.

LONGVIEW, a post village, the capital of Gregg Co., Texas, on Sabine river, 125 miles E. of Dallas, on the St. Louis South-Western and the Texas and Pacific railroads; has saw and planing-mills, plow-works, and a foundry; and ships lumber, cotton, hides, etc. Pop. 1890, 2,034; 1900, 3,591.

LONGWALL SYSTEM. See COAL, *ante*, pp. 842-43.

LÖNNROT, ELIAS, a Finnish philologist; born at Sammatti, near Helsingfors, April 9, 1802. After obtaining the degree of M.D. at the University of Helsingfors in 1832 and practicing as a physician at Kajana, he was, in 1853, made professor of Finnish language and literature at the University of Helsingfors, having for years collected Finnish songs, proverbs and tales and studied the Finnish language thoroughly. His master work is the gathering and compilation of the *Kalevala*, a national epic, consisting of a collection of poetical folk-lore, and imitated by Longfellow in his *Hiawatha*. He died March 19, 1884. See FINLAND, Vol. IX, pp. 219, 220.

LOO-CHOO. See LEW-CHEW, Vol. XIV, pp. 489, 490.

LOOKOUT, CAPE, the most southerly point of Carteret County, North Carolina, extending southward into the Atlantic, in lat. 34° 35' N., long. 76° 34' W.

LOOM. What appears to be the most important improvement which has been made in looms since the time of Jacquard was placed on the market by the Hunt Loom and Fabric Company of San Francisco in 1876. It is a self-feeding attachment, by means of which the loom weaves with a continuous supply of filling-thread. All the waste of weft is saved, and there is no stopping of the loom, except to repair a broken warp-thread. When such break occurs the loom stops automatically and a bell is rung. As a result, one attendant can run a large number of looms.

The latest form of Jacquard silk-loom, as built by Knowles, has a heavy frame without harness motion, but arranged for extensive Jacquard patterns, with four sets of cards, and is equivalent to four 600-needle Jacquard machines. Very elaborate patterns result. The Knowles chain-multiplier is attached to this loom, and runs in connection with the box-motion. The power is applied by means of a friction pulley with a brake, so that the loom can start or stop without jar or strain and before the Jacquard cylinders have changed for the next pick. See also WEAVING, Vol. XXIV, pp. 464-466; and TEXTILES, Vol. XXIII, pp. 206, 207.

C. H. COCHRANE.

LOOMIS, ALFRED LEBBEUS, an American physician; born in Bennington, Vermont, June 10, 1831; graduated at Union College in 1851, and received the degree of M.D. from the College of Physicians and Surgeons, New York, in 1853; devoted himself to the study and cure of pulmonary diseases, and soon won a national reputation: visiting physician to Bellevue Hospital in 1860, and to Mount Sinai Hospital in 1874; in 1867 professor of pathology and

practice of medicine at the College of Physicians and Surgeons, to which a friend of his donated \$100,000 for the founding of a Loomis laboratory; president of the New York Pathological and Medical societies, of the New York Academy of Medicine (1890-92), and of the Congress of American Physicians and Surgeons (1894). His best-known books are *Lessons in Physical Diagnosis* (1877); *Diseases of the Respiratory Organs, Heart, and Kidneys* (1876); *Lectures on Fevers* (1882); *Diseases of Old Age* (1882); *Text-Book of Practical Medicine* (1884). Died in New York, Jan. 23, 1895.

LOOMIS, ELIAS, an American physicist; born in Wellington, Connecticut, Aug. 7, 1811; he graduated in 1830 at Yale, where he became tutor from 1833 to 1836; spent a year in Paris, attending the lectures of Arago, Biot, Dulong, etc.; professor of mathematics and natural philosophy in Western Reserve College, Ohio, from 1837 to 1844; professor of natural philosophy in the University of the City of New York from 1844 to 1860, when he was called to the chair of natural philosophy and astronomy in Yale. He published a series of text-books, embracing the whole range of mathematics, natural philosophy, astronomy and meteorology, which reached an aggregate circulation of 500,000 copies. His *Treatise on Analytical Geometry and Calculus* has been translated into the Chinese language, and his *Treatise on Meteorology* into Arabic; his *Treatise on Astronomy* is used as a text-book in England. His scientific papers, exceeding 125 in number, embrace the various departments of meteorology, the phenomena of auroral exhibitions and atmospheric electricity, territorial magnetism, astronomical observations, shooting-stars, solar spots, etc. He assisted in the first observations by which the velocity of the electric fluid on telegraph wires was determined, Jan. 23, 1849. Professor Loomis was a member of the principal scientific societies of the United States and also of several scientific academies of Europe. Among his most prominent books are *Progress of Astronomy* (1850 and 1856); *Natural Philosophy* (1858); *Practical Astronomy* (1855 and 1865). He died in New Haven, Connecticut, Aug. 16, 1889.

LOON OR GREAT NORTHERN DIVER. See LOOM, Vol. XV, p. 2.

LOOSJES, ADRIAAN PIETERSZON. See HOLLAND, Vol. XII, p. 97.

LOPE DE AGUIRRE, a Spanish desperado; born in the province of Asturias, at the beginning of the sixteenth century. While still a youth he went to South America, where, in consequence of his many and terrible crimes in Peru and elsewhere, he was declared an outlaw. He then joined a band of characters like himself, who spread terror wherever they went. He eventually murdered his leader and made himself chief, and later killed several of his comrades from mere wantonness. At length, having committed innumerable crimes, including piracy, he murdered the governor of Venezuela and looted the royal treasury. This thoroughly aroused the authorities, who began a resolute pursuit, and, having captured Aguirre, who was abandoned by most of his men, shot him in 1561.

LOPES OR LOPEZ, FERNÃO, a fifteenth-century chronicler. See PORTUGAL, Vol. XIX, p. 556.

LOPEZ, NARCISO, a Spanish-American soldier; born in Caracas, Venezuela, in 1799. At the beginning of the war of independence in Venezuela, although belonging to an old and wealthy family, he took the popular side, but soon afterward forsook it to enter the Spanish army and was rewarded with the rank of colonel. He then went to Spain and served against the Carlists. In 1839 he was made major-general and was appointed governor of Valencia. In 1843 he retired to private life in Cuba, and in 1848 joined the revolutionary party. On account of the discovery of a conspiracy against the government, in which he was interested, Lopez fled the following year to New York. He afterward led three filibustering expeditions from the United States to Cuba, but was captured and suffered death by the garrote, in Havana, Sept. 1, 1851.

LOPHIODONTIDÆ. See MAMMALIA, Vol. XV, p. 428.

LOPHIOMYS. See MAMMALIA, Vol. XV, p. 418.

LOPHOBRANCHII. See ICHTHYOLOGY, Vol. XII, p. 694.

LOQUAT, a name given to *Eriobotrya japonica* or *Photinia japonica*, a genus of the family *Rosacea*, and associated with apples, pears, etc., in the group *Pomeæ*. As the specific name indicates, it is a native of Japan and eastern Asia, and is in cultivation as a handsome greenhouse shrub or small tree. It has large evergreen leaves, downy yellowish-white flowers, and an edible yellow fruit resembling a small apple.

LORAIN, a post village of Lorain County, central northern Ohio, 25 miles W. of Cleveland, on Lake Erie, at the mouth of Black River, and on the Cleveland, Lorain and Wheeling and the New York, Lake Erie and Western railroads. It has car-shops, churches, a graded school and planing-mills; has an excellent harbor; has natural gas, and is an important coal-shipping point for central Ohio. The Johnson Steel Company here employs two thousand men. There are also extensive brass-works. Population 1890, 4,863; 1900, 16,028.

LORD, JOHN, an American clergyman and lecturer; born in Berwick, Me., Sept. 10, 1812; graduated at Dartmouth in 1833; studied theology at Andover in 1837; after occupying pulpits in the Congregational churches of New Marlboro and Stockbridge, Mass., he decided, in 1843, to devote himself to historical studies and lecturing; in 1843-46 he lectured successfully in England on the Middle Ages; returning to the United States, he started on a lecturing career that lasted almost fifty years and included over 6,000 lectures; he held a professorship of history at Dartmouth from 1860 to 1876. His noteworthy works are *Modern History for Schools* (1850); *The Old Roman World* (1867); *Ancient States and Empires* (1869); *Points of History* (1881); and *Life of Emma Willard* (1883). At the time of his death he was engaged on a revision of his *Beacon Lights of History* (5 vols., 1883). He died in Stamford, Conn., Dec. 15, 1894.



LORDS, HOUSE OF. See PARLIAMENT, Vol. XVIII, pp. 310-314.

LORD'S SUPPER. See EUCHARIST, Vol. VIII, pp. 650-654.

LORELEI, a cliff on the right bank of the Rhine, half a mile above St. Goar. It rises perpendicularly to a height of 427 feet, and is penetrated by a railway tunnel. Here is the famous echo, celebrated in Heine's exquisite *Volkslied*, based on the tradition of the cave in the rock, the abode of the Lorelei, a water-maiden, whose song and beauty allured boatmen into a whirlpool at the base of the rock. Near its foot is a basin, which is noted for its abundance of trout. The scenery here is regarded as the most magnificent on the Rhine.

LORENZETTI, AMEROGIO. See SCHOOLS OF PAINTING, Vol. XXI, p. 434.

LORETTO, SISTERS OF, a Roman Catholic order of nuns who devote themselves to the cause of education and the care of poor orphans; was founded by Charles Nerinck, a priest (1761-1824), who started the first community, in Kentucky, in 1812; since then it has prospered, and owns and manages several orphanages in the United States, and an academy at Florissant, Missouri.

LORICATA. See ROTIFERA, Vol. XXI, p. 8.

LORIMER, JAMES, a Scotch lawyer and educator; born at Aberdalgie, near Perth, Scotland, Nov. 4, 1818. He graduated at the University of Edinburgh, and subsequently studied at the Academy of Geneva and at the Universities of Berlin and Bonn. In 1845 he became a member of the Scotch bar, and in 1862 professor of public law at the University of Edinburgh. He was one of the founders of the Institute of International Law in 1873. He died in 1890.

LORING, GEORGE BAILEY, American agriculturist; born in North Andover, Mass., Nov. 8, 1817. Educated at Harvard University and at the medical department, he was appointed in 1843 surgeon to the Marine Hospital at Chelsea. In 1849 he was appointed on a commission to revise the system of the United States marine hospitals. For many years he devoted himself to the study of theoretical and practical agriculture and wrote many papers thereon. He was United States Centennial commissioner (1872-76); president of the state senate of Massachusetts (1873-77); member of Congress (1876-81); and Commissioner of Agriculture (1881-85). In 1889 he was appointed minister to Portugal, resigning in 1890. He delivered several notable addresses at anniversary and centennial celebrations of towns, and wrote various papers touching his favorite subject, including *Relations of Agriculture to the State in Time of War* (1862); *Classical Culture* (1866); *Eulogy on Louis Agassiz* (1873); *The Cobden Club and the American Farmer* (1880); etc. He also made a memorable address at the National Cotton Convention at Atlanta (1881), and was a frequent contributor to leading agricultural publications. Died in Salem, Mass., Sept. 14, 1891.

LORING, ELLIS GRAY, an American lawyer;

born in Boston, Massachusetts, in 1803. Having partially completed an undergraduate course at Harvard, he studied law, and being admitted to practice, became eminent in his profession. He ardently espoused the cause of negro emancipation, being one of the twelve charter members of the first antislavery society in Boston (1833). He argued effectively before the Massachusetts supreme court in favor of the slave-child "Med," eliciting a decision that every slave brought within the limits of the state by the owner was *ipso facto* free, even the opposing counsel acquiescing in the decision. The case of Abner Kneeland, a professed atheist, indicted for blasphemy, likewise drew from Mr. Loring a powerful plea in behalf of liberty and the right of free speech. It is noteworthy that his adherence to the principles of antislavery involved the highest sacrifice of personal tastes, Wendell Phillips bearing eloquent testimony to Mr. Loring's courageous advocacy of unpopular opinions. He died in Boston, May 24, 1858.

LORING, WILLIAM WING, an American soldier and Confederate general; born in Wilmington, North Carolina, Dec. 4, 1818; at 13 enlisted in a company of volunteers and took part in the Seminole war, attaining the rank of second lieutenant; admitted to the bar in 1842; and having returned to Florida, was chosen to the legislature of that state; at the beginning of the Mexican War was made captain of a regiment of mounted riflemen, emerging from the campaign with the rank of lieutenant-colonel; subsequently ordered to Texas, with the rank of colonel, but resigned his commission in 1861, in order to enter the Confederate service as brigadier-general; fought with distinction, and was promoted to the rank of major-general. In 1869 he accepted a position in the service of the Khedive of Egypt, being made chief of staff and military adviser in an expedition to Abyssinia; decorated by the Khedive, and having been mustered out of the Egyptian service, returned to America, publishing an account of his foreign experience in *A Confederate Soldier in Egypt* (1883). He died in New York City, Dec. 30, 1886.

LORIS-MILIKOFF. See MELIKOFF, in these Supplements.

LORNE, JOHN GEORGE EDWARD HENRY DOUGLAS SUTHERLAND CAMPBELL, MARQUIS OF the eldest son of the Duke of Argyll, a British statesman; born in London, Aug. 6, 1845; educated at Eton, St. Andrews University, and Trinity College, Cambridge; elected to Parliament as a Liberal (1868). In 1871 he married the Princess Louise Caroline Alberta, sixth child of Queen Victoria, and in 1878 was appointed Governor-General of Canada, where he became quite popular. His term of office ex-



(Now)

DUKE OF ARGYLL.

pired in 1883. He wrote *A Trip to the Tropics and Home, through America* (1867); *Guido and Litta, a Poem* (1875); *The Psalms Literally Rendered in Verse* (1877); *A Life of Lord Palmerston* (1890).

LORRAINE, CLAUDE. See CLAUDE, Vol. V, 814.

LORRIS, GUILLAUME DE. See WILLIAM OF LORRIS, Vol. XXIV, pp. 584-85.

LOS ANGELES, a city of southern California, incorporated in 1850; noted for its healthful and beautiful location, and a favorite winter resort for Eastern tourists and invalids. According to the census of 1890 its manufactures had a combined capital of \$7,000,000, employed 5,000 persons, and produced \$10,000,000 worth of merchandise annually. In the vicinity are found gold, silver, coal, and other minerals, and productive petroleum-veins. In 1894-95 numerous petroleum-wells were sunk in different parts of the city, the oil being of a very low grade. Los Angeles is on the Los Angeles Terminal, the Santa Fé, and the Southern Pacific railroads; it has a state normal school, the Medical School of the University of Southern California, several Roman Catholic seminaries, and St. Vincent (Roman Catholic) College, and does a large trade in oranges, wines, raisins, and other southern fruits. Its chief manufacture is that of water-pipes for irrigation works. Pop. 1890, 50,395; 1900, 102,479. See also LOS ANGELES, Vol. XV, pp. 7, 8.

LOS GATOS, a town of Santa Clara Co., Cal., 8 miles S. of San José, on the Southern Pacific railroad, in a fertile region, where olives and grapes are cultivated; has an ice-factory, wineries, a canner, box-factory, fruit-drier, and planing-mills. Pop. 1890, 1,652; 1900, 1,915.

LOSSING, BENSON JOHN, American engraver and historian; born in Beekman, N. Y., Feb. 12, 1813. In 1826-35 he was a watchmaker in Poughkeepsie, and then became co-proprietor and editor of the Poughkeepsie *Telegraph*. In 1836 he began publishing the Poughkeepsie *Casket*, and in 1838 became a wood-engraver in New York city, where he edited *The Family Magazine*, the first fully illustrated periodical in America (1838-40), and *The Young People's Mirror* (1848-49); he edited in Philadelphia *The American Historical Record* (1872-75). He wrote *Pictorial Field-Book of the Revolution* and of *The War of 1812* (1852 and 1868); *History of the United States* (1854-56); *The Civil War in America* (3 vols., 1866-69); *The American Centenary* (2 vols., 1875); *Cyclopædia of American History* (1881); *History of the City of New York* (2 vols., 1884), etc. He also contributed to *Harper's Magazine* and other periodicals, and was a very industrious collector of documents relating to American history. Died near Dover Plains, N. Y., June 3, 1891.

LOSSINI. See LUSSIN, in these Supplements.

LOT, one of the largest tributaries of the Garonne, France, rises on Mont Lozère, in the Cévennes, flows westerly, and joins the Garonne at Aiguillon, after a course of 300 miles, almost two-thirds of which, as far as Entraigues, are navigable; average width in its lower course, 330 to 500 feet.

LOTHAIR II. See GERMANY, Vol. X, p. 488.

LOTHROP, HARRIET MULFORD (STONE), an American authoress, who writes under the pseu-

donym "Margaret Sidney"; born in New Haven, Conn., June 22, 1844. Educated near home, she traveled widely through the United States, and early entered upon a literary life, though she published nothing before 1877, when her short stories and poems began to appear in the periodicals. In 1881 she married Mr. Daniel Lothrop, a well-known Boston publisher, and lived in Hawthorne's old Concord home. She has written *Five Little Peppers and How They Grew* (1882); *The Pettibone Name* (1883); *Ballad of the Lost Hare* (1884); *The Golden West* (1885); *Hester and Other New England Stories* (1886); *Two Modern Little Princes* (1887); *Dilly and the Captain* (1888); *Old Concord* (1888); *Kensington Junior* (1888); *An Adirondack Cabin* (1890); and *Whittier with the Children* (1893).

LOTI, PIERRE. See VIAUD, *post*, pp. 3039-40.

LOTOPHAGI (Gr., "lotus-eaters"). See LOTUS-EATERS, Vol. XV, pp. 11-12.

LOTTO, LORENZO (c. 1476-1555). See SCHOOLS OF PAINTING, Vol. XXI, p. 436.

LOTUS, a genus of the family *Leguminosæ*; but the name is commonly applied to several species of the water-lily family, notably the castalies of the Nile, which were held sacred by the Egyptians. In the United States it is commonly used for the showy *Nelumbium speciosum*, which is a sort of water chinquepin; it also seems to have been applied to several thorny shrubs of the Arabian deserts.

LOUBET, ÉMILE, seventh President of the French republic; born at Marsanne, in Drôme department, Dec. 31, 1838; studied law, obtained the degree of doctor of law, and settled at Montélimar, of which place he was mayor from 1870 till Feb., 1899. In 1876, 1877, and 1881 he was elected to the Chamber of Deputies as a Republican of the Left; in 1885 he was elected to the Senate; and for three months in 1887-88 was Minister of Public Works in the first cabinet of M. Tirard. On Feb. 27, 1892, he became premier and Minister of the Interior; but on Nov. 28 following his ministry was defeated on a question arising out of the Panama Canal scandal and resigned, whereupon M. Ribot became premier (Dec. 5, 1892), and M. Loubet was reappointed Minister of the Interior; but he retired on the reconstruction of the cabinet in Jan., 1893. In 1896 and 1898 he was elected president of the Senate; and, on the sudden death of President Faure, he was, on Feb. 18, 1899, elected to succeed him.

LOUDON, JOHN CLAUDIUS, a Scotch writer and horticulturist; born at Cambuslang, near Glasgow, April 8, 1783; graduated at Edinburgh University; in 1803 went to London, where he became a landscape-gardener. He published the *Encyclopædia of Gardening* (1822); *Encyclopædia of Agriculture*; *Encyclopædia of Plants*; *Encyclopædia of Cottage, Garden, and Villa Architecture* (1832). The publication of his *Arboretum et Fruticetum* (1838), an account of all the trees and shrubs of Great Britain, was so costly as to involve him in financial difficulties. In his later years he lost the use of his hands, but he continued to conduct several magazines on landscape-gardening, with the assistance of his wife, JANE WEBB LOUDON, who was

thoroughly in sympathy with his line of study, and an agreeable writer. He died in London, Dec. 14, 1843.

**LOUDONVILLE**, a post village of Ashland County, central northern Ohio, 50 miles S.W. of Akron, on the Black Fork of the Mohican River and on the Pittsburg, Fort Wayne and Chicago and the Toledo, Walhonding Valley and Ohio railroads. Wheat, corn and wool are the principal products of the neighborhood. It has a tannery and large flour-mills. Population 1900, 3,511.

**LOUDON, JAMES, D.C.L., LL.D.**, President of Toronto University, was born in Toronto in 1841, was educated at the Toronto Grammar School and at Upper Canada College, and entered Toronto University in 1857. He graduated in 1862, winning the gold medal in mathematics. In 1875, after teaching classics, mathematics, and physics, in University College, and filling the post for ten years of Dean of Residence, he was appointed professor of Mathematics and a Senator of the University. On the death of Sir Daniel Wilson, in 1892, Professor Loudon succeeded to the Presidency of the University. He is also a Fellow of the Royal Society of Canada, and has made some important discoveries in geometrical optics. In 1894, the honorary degree of LL.D. was conferred upon him by his *alma mater*, and two years later a similar honor was paid him by Princeton University. In 1900, Trinity University (of Toronto) made him an honorary D.C.L.

**LOUIS I**, late King of Portugal, second son of Donna Maria II, Queen of Portugal, and Dom

Fernando, Prince of Saxe-Coburg, was born October, 1838. He succeeded to the throne on the death of his brother, King Pedro V, Nov. 11, 1861. He married, Oct. 6, 1862, Pia, youngest daughter of Victor Emmanuel, King of Italy, by whom he had two sons: Carlos, born Sept. 28, 1863 (who succeeded him), and Alfonso, born July 31, 1865. He was a man of much culture, and fond of music; he



LOUIS I.

published in 1877 a translation into Portuguese of Shakespeare's *Hamlet*, followed in 1880 by the *Merchant of Venice* and *Richard III*. As a king he proved liberal-minded and faithful to the letter and spirit of the Portuguese constitution. He died in Lisbon, Oct. 18, 1889.

**LOUIS (LUDWIG) I, KARL AUGUST**, King of Bavaria; born in Strasburg, Aug. 25, 1786. A highly educated monarch, devoted more to art and literature than to affairs of state. The famous Glyptothek, at Munich, is a monument to his enthusiasm for esthetic culture. His gifted character contrasted strangely with his scandalous liaison with Lola Montez, by which he sacrificed the love and respect of his people. Having as-

cended the throne in 1825, after the revolution of 1848 he abdicated in favor of his son Maximilian Joseph (Maximilian II). He died in Nice, Feb. 29, 1868.

**LOUIS II, OTTO FREDERICK WILLIAM**, son of Maximilian II, King of Bavaria; born in Nymphenburg, Aug. 25, 1845; succeeded his father March 10, 1864. In him his grandfather's ardent love of the beautiful was intensified, assuming the most fantastic forms, imbued with melancholy romance. Although destined to take an active part in political affairs of vital importance, siding with Austria in 1866 and with Prussia in 1870-71, and manifesting no little insight into intricate mat-



LOUIS II, KING OF BAVARIA.

ters of state, he became at length a recluse, rarely mingling with his people and evidently averse to public festivities. Amid the sublimity of mountain scenery, dwelling alone in sumptuous palaces and surrounded by objects of artistic luxury and the most refined taste, his strange nature was absorbed in studious reverie, his solitary thoughts finding their highest expression in a passionate love of music. To this happy predilection was due the dramatic development of modern music under Richard Wagner, of whom the young king became an ardent patron and admirer. Mental alienation, however, had already declared itself in eccentricities affecting the welfare of the state. In 1886 Louis was confined in the palace of Berg, near Munich, and three days after committed suicide by drowning. See also **BAVARIA**, Vol. III, p. 454.

**LOUIS IV, FREDERICK WILLIAM LOUIS CHARLES**, Grand Duke of Hesse-Darmstadt; born Sept. 12, 1837. He married the Princess Alice, second daughter of Queen Victoria, July 1, 1862. He succeeded to the grand-dukedom on the death of his uncle, Louis III, June 13, 1877, and on Dec. 14, 1878 was left a widower with one son and four daughters, one of whom married Nicolas II, Czar of Russia. Some years later he morganatically married Madame de Kolomine, but after a short time divorced her. He died March 13, 1892.

**LOUIS, PIERRE CHARLES ALEXANDER**. See **MEDICINE**, Vol. XV, p. 816.

**LOUISBURG**, a famous fortress, built by the French soon after the peace of Utrecht, in 1713; on the southeast coast of Cape Breton Island, in Nova Scotia, lat. 45° 53' 30" N., long. 60° W. Its excellent harbor induced the French, who early settled in the place, to build a very strong fortress here, at an expense of thirty million francs. During the war between France and England, which broke out in 1744, the New England colonists attacked this place, as it menaced their fisheries by sheltering French privateers.

The New Englanders, 4,000 strong, besieged Louisburg, and the garrison, 1,600 strong, were compelled to surrender, June 28, 1745. By the peace of Aix-la-Chapelle, in 1748, the town was restored to France.

In 1758 a British general, Wolfe, the subsequent hero of Quebec, besieged Louisburg, and compelled the French garrison to surrender as prisoners of war. The town was then made the heap of ruins which still remain. In 1895 a population of 1,100, mostly fishermen, lived at Louisburg, which is still a British possession.

LOUISIADE ARCHIPELAGO, a group of islands in Melanesia, southeast of the coast of New Guinea, between lat. 10° and 12° S. and long. 151° 30' and 154° 30' E. They extend about 240 miles in an east-southeasterly direction, and have an area of 850 square miles—South-east, the largest, containing 380 square miles. Gold has been found on Misima and Tagula. Misima is the most populous, having about 4,000 inhabitants. The people are mostly pure Papuans, though there are a few Malaysians. The chief exports, besides gold, are trepang, copra, and pearl shells.

LOUISIANA has an area of 48,720 square miles, of which 45,420 is land area, the remainder being land-locked bays, inland lakes and river surface. The population in 1890, according to



STATE SEAL OF LOUISIANA.

the decennial census, was 1,118,587, consisting of 558,395 whites, 559,193 negroes and 999 Chinese, Japanese and civilized Indians. The percentage of increase in population for the ten years 1890 to 1900, was 23.5, the density to the square mile at the latter date being 30.4. The state had three cities, in which resided 264,496 of the population, constituting 23.65 per cent of the entire number of inhabitants. The number of males was 559,350, of females 559,237, making the number of females to each 100,000 males 99,980, a more nearly equal division between the sexes than that possessed by any other state of the Union. The population of the state for 1900 (12th census), was 1,381,625. The negro population increased 75,538 in the ten years, 1880 to 1890, the number at the latter date being 559,193. Of the 69,294 farms in Louisiana 2,196 are under 10 acres; 10,270, 10 and under 20; 22,148, 20 and under 50; 11,271, 50 and under 100; 20,109, 100 and under 500; 2,023, 500 and under 1,000, and 1,277, 1,000 acres and over.

The following is an abstract of the agricultural statistics of Louisiana, as gathered from the census returns. The corresponding figures for 1880 are also given, the comparisons showing much to the credit of the state:

ITEMS.	1890.	1880.
Total number of farms .....	69,294	48,292
Acres in farms .....	9,544,219	8,273,506
Value of farms, fences and buildings .....	\$85,381,270	\$58,989,117
Value of farm-implements and machinery .....	\$7,167,355	\$ 5,435,525
Value of live-stock .....	\$17,898,380	\$12,345,905
Estimated value of all farm products .....	\$54,343,953	\$42,883,522
Bushels of Indian corn .....	13,081,954	9,889,689
Bushels of oats raised .....	297,271	229,840
Acres in cotton .....	1,270,154	864,787
Bales of cotton produced .....	659,180	508,569
Acres planted in cane .....	193,694	181,592
Pounds of sugar produced .....	292,124,050	206,047,200
Gallons of molasses .....	14,341,081	11,696,248
Acres in rice .....	84,377	42,000
Pounds of rice produced .....	75,645,433	23,188,311
Bushels of Irish potatoes .....	375,842	180,115
Bushels of sweet potatoes .....	1,912,080	1,318,110

Of the 29,000,000 acres in Louisiana, only 2,507,935 are under cultivation. The gain in values noted in the table given above has continued since the census year, as is shown by the report of 1894, which places the value of the agricultural products for the year at the sum of \$75,000,000, distributed as follows: Sugar, \$35,000,000; cotton, \$21,000,000; rice, \$3,000,000; fruits and vegetables, \$2,000,000; corn, oats and hay, \$10,000,000; oranges, \$1,000,000; live-stock and other products, \$3,000,000. The growth of all agricultural industries has been prodigious, especially in the southwestern part of the state, where the cultivation of rice was not taken up to any extent until 1884, when immigration from the northwestern states set in. In the year mentioned but one harvesting-machine for gathering rice was in use, and but 250 cars of rice were shipped. In the next year there were five machines; in 1886, there were 50; in 1887, 200; in 1888, 400; in 1890 there were 1,000 machines, and the shipments of rice had grown to more than 2,000 cars. In 1891 there were 2,000 machines, and the shipments of rice more than 5,000 cars; in 1893 the number of machines was in excess of 3,000, and the shipments more than 10,000 cars. In 1895 Louisiana produced four-fifths of the crop of the United States. The centenary of sugar-manufacturing in the state was celebrated in 1894. A school of training in the scientific manufacture of sugar has been established, its first class being graduated on the day of the celebration, the buildings connected with the school standing on the same spot on which the first sugar was made in Louisiana in 1794 by Étienne de Bore. An experimental farm is attached to the school, and a course of three years covers chemistry, mechanics, agriculture, sugar-making and drawing of sugar machinery. Students attend from Mexico, the Spanish West Indies, and from Spain, in addition to the liberal patronage given the school from Louisiana and other of the sugar-making states.

Tobacco is extensively grown, and many manufacturing factories have been established near the seat of

production, thus saving all freights on the raw article.

Garden products, fruits, watermelons and cantaloupes are raised, and shipped from points along the lines of railway to New Orleans and also to northern cities. Grapes, strawberries and figs flourish in nearly all parts of the state, and pears, pomgranates and olives are raised with much profit in many sections. Oranges are raised along the gulf coast, and the annual crop is one of much value. Sweet potatoes are extensively cultivated, and of late years the Irish potato has received much attention at the hands of those situated along the lines of railway. The crop is harvested from March to June, and by means of rapid transit they are placed in the northern markets at a time when prices are higher than at any other season of the year. By reason of the climate, and the native grasses, which grow luxuriantly for nine months in the year, stock-raising is an industry of great profit and is receiving more attention at the hands of agriculturists from year to year. Horses and mules, sheep and hogs are all reared with little attention or artificial food, and the ease of reaching markets given by the numerous lines of railway makes the industry a profitable one.

According to the census of 1890 the sum of \$34,754,121 was invested in the 2,613 specific manufacturing industries of Louisiana, giving employment to 31,901 persons, who received in wages the annual sum of \$13,159,564. The value of the material used was then estimated at \$33,282,724 and the finished products were of the total value of \$57,806,713. The principal industry was the manufacture of sugar and molasses-refining, which returned \$12,603,913. This was followed by lumber and other mill products from logs and bolts to the value of \$5,599,744. Rice cleaning and polishing yielded \$4,009,901. Other industries of importance were men's clothing (factory product), foundry and machine-shop products, leather, cotton-compressing and oil, cotton-seed and cake.

The enrollment in the public schools of Louisiana for 1894, as reported by the state board of education in October, 1895, was 155,926, the average attendance being 109,435. The number of public schools was 2,746, an increase of 101 over the preceding year. Eight hundred and twenty-five schools were devoted to negro youth and 915 negro teachers employed. The total receipts for school purposes for the year amounted to \$1,166,995, the expenditures to \$732,388. Much interest is taken in the cause of education, the legislature appropriating money for the first time for the maintenance of teachers' institutes. The state normal school has been in existence for ten years, and has sent out 167 graduates. The spring term of 1894 had an attendance of 193 students and 107 in the model department. The State University and Agricultural and Mechanical College had 194 students, of whom 85 were in the collegiate course. The leading institution of higher education is Tulane University (q. v., in these Supplements). Col-

leges under church supervision are the Centenary College, managed by the Methodist Episcopal Church South, and located at Jackson; Leland University, for negro students, under the auspices of the Baptists, at New Orleans; Keachie College, at the town of the same name, under Baptist control, and Jefferson College, at Convent, and the College of the Immaculate Conception, at New Orleans, both under the control of the Roman Catholic Church. The Methodist Episcopal Church controls New Orleans University, at New Orleans, and at the same place the Congregational Church has established Straight University.

The net state debt of Louisiana in 1894 amounted to \$11,262,164, and the estimated value of all property within the state for the purposes of taxation in 1893 was \$247,500,000. At the date mentioned the rate of taxation was six mills.

Jan. 1, 1899, there were 218 newspapers published in the state. Every parish of the 59 into which Louisiana is divided published a paper; and of the 95 towns in which periodicals were issued 57 were parish seats. Of the total number of papers, 22 were daily, 1 triweekly, 3 semiweekly, 178 weekly, 4 semimonthly, and 10 monthly.

The convicts of the state had been leased to contractors up to 1894, when the legislature abolished the system and placed the penitentiary at Baton Rouge in charge of a board of control. The number of convicts was about one thousand the average for several years. The insane asylum at Jackson reported 700 inmates, and an additional building is in course of erection, to accommodate 400 more. The school for deaf mutes at Baton Rouge had 60 pupils at the close of 1895, the cost to the state for the year being about fourteen thousand dollars. The state school for the blind located at Baton Rouge, was established in 1851, and has a large number of pupils.

There are about two thousand miles of railroad in operation in the state, the increase in mileage having been very rapid within the past 15 years. In 1850 there were but 80 miles; in 1860, 335; in 1870, 450; in 1880, 672; in 1890, 1,739.

The church organizations of Louisiana numbered 2,701 in 1890, and the edifices 2,520. The seating-capacity was 617,245, the number of communicants 399,991, and the value of all church property \$5,032,194. The leading denomination was the negro Baptist, with 876 organizations, all Baptist bodies numbering 1,441. Next in importance was the Methodist Episcopal South, numbering 316 organizations, followed by the Methodist Episcopal, with 218 organizations, all Methodist bodies numbering 810. The Roman Catholics numbered 206 organizations, their membership and value of property being greater, however, than those of any other religious body.

There are about sixty banks in the state, the number of national institutions being about twenty, with a capital of \$4,000,000. The state banks number about 25, their aggregate capital being near \$3,000,000. Private and miscellaneous banks

and investment companies make reports showing them to be in good financial condition.

The chief cities and towns, with their census populations in 1900, are: New Orleans, 287,104; Shreveport, 16,013; Baton Rouge, the capital, 11,269; New Iberia, 3,447; Lake Charles, 6,680; Gretna, 3,332; Monroe, 5,428; Plaquemine, 3,590; Donaldsonville, 4,105; Alexandria, 5,648; Morgan City, 2,332.

On May 12, 1898, a new state constitution was adopted.

The following is a list of the Governors of Louisiana from 1812, the date of the admission of the state to the Union, with their respective terms of office: William C. C. Claiborne, 1812-16; James Villere, 1816-20; Thomas B. Robertson, 1820-24; H. S. Thibodeaux (acting), 1824; Henry Johnson, 1824-28; Pierre Debigny, 1828-29; A. Beauvais, 1829-30; Jacques Dupré, 1830-31; Andre B. Roman, 1831-34; Edward D. White, 1834-38; Andre B. Roman, 1838-41; Alexander Monton, 1841-45; Isaac Johnson, 1845-50; Joseph Walker, 1850-54; Paul O. Herbert, 1854-58; Robert C. Wickliffe, 1858-60; Thomas O. Moore, 1860-64; Michael Hahn, 1864 (*a*); Henry F. Allen 1864 (*b*); James M. Wells 1864-67 (*c*); B. F. Flanders 1867-68 (*d*); Henry C. Warmouth, 1868-72; William Pitt Kellogg, 1872; John McEnery, 1872-77 (*c*), Francis T. Nichols 1877-80; Louis Alfred Wiltz, 1880-81; Samuel D. McEnery, 1881-88; Francis T. Nichols, 1888-92; Murphy J. Foster, 1892. See LOUISIANA, Vol. XV, pp. 20-22.

LOUISIANA, a city of Pike County, north-eastern Missouri, on the Mississippi River, 98 miles above St. Louis, on the Chicago and Alton and the St. Louis, Keokuk and Northern railroads. It has gas-works, tobacco factories, steam flour, planing and lumber mills, machine-shops, nurseries, stone-quarries and lime-kilns, and the surrounding region produces lumber and fruit. It is the seat of McClure College (Baptist, opened in 1880); has a school library, and gas and electric lights. Population 1890, 5,090; 1900, 5,131.

LOUISVILLE, the largest city in Kentucky. Its rate of increase, however, during the last decade has not been sufficient (30.2 per cent) to keep its rank, and in 1890 it had sunk to twentieth in the Union. The census of 1890 gives the following summary of the industries of Louisville:

	1890.
Number of establishments reporting-----	1,622
Industries represented .....	161
Number of hands employed .....	24,807
Capital invested.....	\$30,542,947
Value of material .....	\$22,870,000
Value of products .....	\$45,452,209

The most important industries are iron-working, agricultural tool-making, tobacco, cigar and cigarette manufacturing, and sugar-curing hams. It is the largest leaf-tobacco and whisky market in the world, and has an extensive trade in corn, iron, pork and wheat. Louisville has several parks, aggregating about 1,000 acres. It had, in 1894, 176 churches, of which 41 were Baptist, 32 Methodist, 24 Roman Catholic, 17 Episcopalian

(*a*) New Orleans and vicinity. (*b*) Federal. (*c*) Confederate portion. (*d*) Not recognized by Congress. (*e*) Military.

and 22 Presbyterian. Of these, the Warren Memorial, the Calvary and the Cathedral are fine specimens of ecclesiastical architecture. There are 42 public schools, attended by 25,000 pupils, for the support of which \$550,000 is annually appropriated. Besides these, there are numerous professional colleges and schools. The public library, being that of the Polytechnic Society, contains 50,000 volumes. There were between forty and fifty asylums, hospitals, homes, orphanages, etc. The city is supplied with sewer systems, water, gas (natural and manufactured), and electricity, and has a good fire department. There are 102 miles of street-railway, together with 24 miles of suburban and steam roads. The most important railroad lines which enter here are the Louisville and Nashville, the Southern, the Chesapeake, Ohio and Southwestern, and the Ohio River railroads. Population 1890, 161,129; increase since 1880, 37,371; 1900, 204,731. See LOUISVILLE, Vol. XV, pp. 22-24.

LOUNSBURY, THOMAS RAYNESFORD, an American soldier and author; born at Ovid, New York, Jan. 1, 1838; graduated at Yale (1859), and was engaged in literary work until the outbreak of the Civil War, when he joined the One Hundred and Twenty-sixth New York Volunteers as a lieutenant, remaining in the army until 1865. In 1871 he was appointed professor of English in the Sheffield Scientific School of Yale University. He wrote a *History of the English Language* (1879) and *Studies in Chaucer* (3 vols., 1892).

L'OUVERTURE, TOUSSAINT. See TOUSSAINT, Vol. XXIII, p. 492.

LOUVRE, the finest and largest public building in Paris, the more ancient portion of which was used as a palace by the kings of France up to the seventeenth century; now entirely devoted to superb collections of paintings, specimens of sculpture, antiquities and rare curios from all times and countries. A portion of the buildings also contain a large public library and national archives. For a description of the edifice see PARIS, Vol. XVIII, p. 276; also, SCHOOLS OF PAINTING, Vol. XXI, p. 445. Only works of artists who are dead are admitted in the Louvre galleries.

LOVEDALE, a town in the department of Victoria East, of Cape Colony, Southern Africa, founded in 1841 by Scotch missionaries; wholly given up to the education of natives, who are taught various industrial pursuits and fitted for missionary service. Bibles are printed here by natives, and extensively circulated.

LOVE FEASTS. See AGAPE, Vol. I, p. 274; and METHODISTS, Vol. XVI, p. 188.

LOVEJOY, ELIJAH PARISH, an American abolitionist; born in Albion, Maine, Nov. 9, 1802; assassinated in Alton, Illinois, Nov. 7, 1837. In 1827 he established a school in St. Louis, Missouri, contributed articles and poems to the press, and in 1829 became editor of a political paper that supported Henry Clay as a Presidential candidate. In 1833 he was licensed to preach by the Presbyterian church, and established a

religious paper called the *Observer*, in which he condemned slavery. Threats of violence compelled him to remove his paper to Alton, Illinois. Even there his press was destroyed three times by mobs, mostly composed of Missourians. At the fourth attack he and his friends defended the office, and thought they had compelled the mob to withdraw; but when Lovejoy opened the door he was instantly pierced by five bullets. His Memoir was published by his brothers, with a preface by J. Q. Adams. In 1894 the Illinois legislature appropriated \$25,000 to be used in the construction of a monument in honor of Elijah Parish Lovejoy, in the city of Alton, to be erected on a lot set apart in the cemetery and overlooking the Mississippi River.

LOVEJOY, OWEN, an American abolitionist, and a brother of the preceding; born in Albion, Maine, Jan. 6, 1811; died in Brooklyn, New York, March 25, 1864. He emigrated to Alton, Illinois, before completing his studies at Bowdoin, and soon entered the ministry. He was present at his brother's murder. In 1838 he became pastor of the Congregational church at Princeton, Illinois, and, in violation of the law then in force, held anti-slavery meetings in all parts of the state until 1854, when he was elected to the legislature. In 1856 he was sent to Congress, and re-elected in 1858, 1860 and 1862. In one of his fiery anti-slavery speeches delivered in Congress at the beginning of the Civil War, he related the circumstances of his martyred brother's death.

LOVELL, MANSFIELD, an American soldier; born in Washington, District of Columbia, Oct. 20, 1822. He graduated at West Point in 1842; served in Texas and Mexico, being wounded at Monterey and again at the assault on the City of Mexico. He resigned to accept the office of superintendent of street improvement of New York City. At the outbreak of the Civil War he entered the Confederate service, and in October, 1861, was commissioned major-general and given command of the defenses of New Orleans. He withdrew his troops when the forts were captured; afterward commanded a division at Corinth, and succeeded General L. Polk in 1864. Later he became assistant of General Newton in the work

removing obstructions from the East River, New York. He died in New York City, June 1, 1884.

LOW, SETH, an American educator; born in Brooklyn, New York, Jan. 18, 1850; graduated at Columbia College (1870), and immediately entered the mercantile house of his father, in which, in 1875, he became a partner. In 1881



SETH LOW.

he was elected mayor of Brooklyn, on an independent ticket, and served for two terms. During

his administration he accomplished much in purifying municipal politics, achieving for himself a national reputation. On leaving that office he returned to active business until his election in 1889 to the presidency of Columbia College, of which he was already a trustee. His fine influence and vigorous administration, no less than his signal liberality in the way of material aid, have greatly assisted the healthy development which Columbia College has enjoyed.

LOW, WILL HICOCK, American artist; born in Albany, N. Y., May 31, 1853; a pupil of Carolus-Duran, in Paris; has devoted himself specially to high-class illustrations, genre painting, decorative work, and designs for stained glass; received a second medal at the Paris Exposition, 1889; elected National Academician (1890); designed the diploma of awards for the Chicago Exposition, 1893. His drawings for Keat's *Lamia* and *Odes and Sonnets* were much admired.



WILLIAM HICOCK LOW.

Among his recent paintings are *Welcome* and *Parting*, in the rotunda of the Plaza Hotel, New York.

LOWE, SIR DRURY CURZON DRURY, a British soldier; born in 1830, in England; graduated at Oxford; entered the army in 1854; became a full colonel in 1871; served with the Seventeenth Lancers in the Crimea, and also in the Indian mutiny; commanded the cavalry of the Second division in the Zulu war, and led the charge at the conclusion of the battle of Ulundi, being wounded during a charge. In the Egyptian expedition of 1882 he commanded the cavalry brigade and took part in the battle of Tel-el-Kebir, immediately after which, by a forced march, he took possession of Cairo, its citadel, and captured the rebel Arabi Pasha. For his services he was created K. C. B., and received the thanks of Parliament and also the second class of the Osmanli; from 1885 to 1890 he was in command of the cavalry brigade at Aldershot, and inspector-general of cavalry with the rank of lieutenant-general.

LOWE, EDWARD JOSEPH, an English meteorologist and naturalist; born at Highfield, England, Nov. 11, 1825. In 1840 he began a valuable series of daily meteorological observations, which were continued to April, 1882. In 1848 he first indicated the radiation of meteors from a point in the heavens. He was one of the founders of the Royal Meteorological Society. He took part in the government expedition to Spain in 1860, for the purpose of observing a solar eclipse. Until 1882 he furnished the United States government with synchronous meteorological observations. He took also a great interest in natural history, especially botany and conchology, raising himself a number of curious species of British ferns. Among his many books are *A Treatise on Atmospheric Phenomena* (1846); *The Conchology of Nottinghamshire* (1853); *Natural His-*

*tory of British and Exotic Ferns* (1854); *British Grasses* (1858); *Chronology of the Seasons*.

LOWE, SIR HUDSON, a British soldier; born at Galway, Ireland, July 28, 1769. Entering the army in 1787, he served in various parts of the Mediterranean, aided in the conquest of the Ionian Islands and became their first governor; afterward for some time attached to the Prussian army under Blücher; in 1814 he carried to London the news of Napoleon's first abdication, and was knighted and promoted on that account; was quartermaster in Wellington's army (1815) until removed by the Iron Duke. In the spring of 1816 he became governor of St. Helena, with the custody of Napoleon, who had landed there in the previous October. The strictness of Lowe's watch of his charge brought upon him bitter attacks from Napoleon's friends and admirers. He published a defense of his conduct in a *Mémorial Relatif à la Captivité de Napoléon à Ste. Hélène* (2 vols., Paris, 1830). In 1825 Sir Hudson Lowe was appointed commander of the forces in Ceylon; he was made a lieutenant-general in 1830. In 1853 appeared from his pen *A History of the Captivity of Napoleon, from Lowe's Journal*, an important contribution to the Napoleonic bibliography. He died in London, July 10, 1844.

LOWE, ROBERT. See *SHERBROOKE, LORD*, in these Supplements.

LOWE, THADDEUS S. C., an American aeronaut, inventor and engineer; born in Jefferson, New Hampshire, Aug. 20, 1832; began to make high ascensions in 1858, and reached an altitude of 23,000 feet. During the Civil War he was placed in charge of a service of observation-balloons, but, although partially successful, met with such opposition on the part of the engineer corps that he had to abandon his position. He invented a portable apparatus for generating hydrogen gas for war-balloons, and also an ice-making machine; and he was the first to produce, in commercial quantities, illuminating gas made by the decomposition of water and the addition of crude petroleum, his system being widely employed. In 1890 he removed to Pasadena, California, and projected, planned and built the Mount Lowe railway, extending from Altadena, at the base of the Sierra Madre Mountains, to the summit of Mount Lowe, their highest peak, 6,300 feet above the sea.

LOWELL, a manufacturing city of northeastern Massachusetts. The site is uneven and hilly, and the river falls 33 feet, affording great hydraulic power, which is controlled by a chartered company. Steam-power, however, is now very largely used in the large mills and work shops. The manufactories of Lowell had, in 1890, a combined capital of \$40,000,000, employed over 28,000 hands and produced \$27,000,000 worth of merchandise annually. Unusual attention is paid to the well-being of the work-people. Lowell has a public library of 55,000 volumes, a system of water-works, owned by the city, costing \$2,400,000, and electric and gas lights. It has electric street-railways, which also connect it with the neighboring towns. Its valuation (1896) was \$68,782,042; tax rate, 1.8 per cent; net debt, \$3,000,000. Population 1890, 77,606; 1900, 94,-

969; rank among United States cities, 37. See *LOWELL*, Vol. XV, pp. 29, 30.

LOWELL, a post village of Kent County, southwestern Michigan, 17 miles E. of Grand Rapids, situated at the confluence of the Grand and Flat rivers, and on the Detroit, Grand Haven and Milwaukee and the Lowell and Hastings railroads. It is in a grain and fruit growing region, and has excellent water-power. It contains two flour-mills, a cutter factory turning out twenty thousand cutters a year, axe, woolen, furniture and numerous other factories. Population 1890, 1,829; 1900, 1,736.

LOWELL, CHARLES RUSSELL, an American soldier and the grandson of John Lowell, the statesman; born in Boston, Jan. 2, 1835. He graduated with highest honors from Harvard (1854); entered the iron-manufacturing business; at the outbreak of the Civil War he joined the United States cavalry as captain; after serving on McClellan's staff he organized and commanded the Second Massachusetts Cavalry (1863); served under Sheridan and engaged in the pursuit of Mosby's guerrillas; made brigadier-general of volunteers (1864); during his term of service he had twelve horses killed under him, but was wounded at Cedar Creek for the first time; he died from other wounds shortly afterward. His manly and chivalrous character was well expressed in his own motto, "A man has no right to himself, and until he knows and feels this, he can be of no service to others." He died near Middletown, Virginia, Oct. 20, 1864.—His wife, JOSEPHINE SHAW LOWELL, an American philanthropist, was born in West Roxbury, Massachusetts, Dec. 16, 1843. After her husband's death (they had been married only two years) she gave herself up to philanthropic work. In 1877 she was appointed upon the New York State Board of Charities, being one of its most efficient and untiring members until her resignation in 1889. She was gifted with a rare insight into the underlying principles which should govern the disbursement both of public relief and private charity, and her comprehensive grasp of economic details enabled her to dispense wisely the aid at her command. Her official reports, based upon personal observation and study, as well as occasional papers committed to public print, are among the most feeling, intelligent and practical contributions to applied social science.

LOWELL, JAMES RUSSELL, an American *littérateur*, poet and diplomatist, was born in Cambridge, Massachusetts, Feb. 22, 1819, and died at the same place, Aug. 12, 1891. His father was a Boston clergyman and friend of W. E. Channing. The son graduated at Harvard in the class of 1838, and two years afterward was admitted to the bar, but never practiced law. Literature from the first seemed his chosen calling, for so early as 1843



JAMES RUSSELL LOWELL.



he founded a magazine, *The Pioneer*, but it was short-lived. Previous to this (in 1841), his early poems, entitled *A Year's Life*, were published. At this period he actively espoused the anti-slavery side, and took a lively interest in various political and philanthropic questions of the time. In 1844-45 a further collection of his poems appeared, together with a series of literary criticisms, entitled *Conversations on Some of the Old Poets*. A third gathering of poems appeared in 1848, entitled *The Vision of Sir Launfal*, the chief poem being founded on the legend of the San Graal, and enshrining some beautiful and romantic verse. His reputation, however, was made by two notable volumes of literary and political satire: *A Fable for Critics*, in which he passes in review the *literati* of the time, and his *Biglow Papers*, in which the poet lashes, in Yankee vernacular, the policy of the pro-slavery faction and the attitude of the United States toward Mexico, with which country the nation was then at war. Mr. Lowell visited Europe in 1851 and again in 1855, returning in the latter year to fill the chair of modern languages at Harvard. In 1857 he became the first editor of the *Atlantic Monthly*, and, six years later, he commenced a ten-years' connection with the *North American Review*. To this latter periodical he contributed some graphic studies of Cambridge in the olden time, afterward published as *Fireside Travels* (1864), and two volumes of criticism of high and enduring value: *Among My Books* (1870); and *My Study Windows* (1871). In 1864 he brought out a second series of *The Biglow Papers*, and in the following year he recited, at Harvard, and afterward published, his magnificent *Commemoration Ode*, in honor of the alumni who had fallen in the Civil War. In 1877 he was appointed Minister to Spain, and in 1880 Minister to the court of St. James, London. In England he remained until 1885, and won the hearts and admiration of the English people with his fine literary and oratorical gifts. In 1869 Mr. Lowell published a new collection of verse, *Under the Willows*, and in the following year a thoughtful epic poem, *The Cathedral*, suggested by a visit to Chartres. *Three Memorial Poems* appeared in 1876; and in 1881 a new edition of his complete works, in five volumes, was issued. The *Memorial Poems* were odes, celebrating the hundredth anniversary of the Fourth of July, the battle at Concord, and apostrophizing the Washington elm-tree at Cambridge. In 1886 appeared *Democracy*, embracing his addresses delivered in England while ambassador there; and in 1888 a series of *Political Addresses* appeared, with *Heartcase and Rue*, a sheaf of later poems. The Riverside edition of his complete writings, in 12 volumes, was issued in 1890-92. His *Letters*, edited by C. E. Norton, were issued in 1893. Lowell was a man of strong mental fiber, and represents the highest type of culture in the New World and its sturdiest patriotism. He was a keen and appreciative critic, and his poems, though unequal, abound in many fine passages. He had a fine sense of humor, though sometimes tinged with rough speech. His literary instinct and sense of the beautiful impart a rich color to his work, while his learning gives it substance

and his satire adds spice.—His elder brother, ROBERT TRAILL SPENCE LOWELL, an American clergyman, was born in Boston, Oct. 8, 1816, and died Sept. 12, 1891, in Schenectady. He graduated at Harvard in 1833, and in 1842 was ordained priest in the Episcopal Church. For a time he acted as bishop's chaplain in the Bermuda Islands, and afterward was rector of a parish at Bay Roberts, Newfoundland, where, during the famine of 1846, he rendered humane service as a medical man and missionary. In 1847, owing to failing health, he returned to the United States and conducted a poor mission in Newark, New Jersey. From 1859 to 1869 he was rector of Christ Church, Duaneburg, New York, and later on was for four years headmaster at St. Mark's School, Southboro, Massachusetts. He afterward became Latin professor at Union College, and contributed considerably to current periodical literature. He wrote *Antony Brade*, a tale of school-boy life; a volume of poems, entitled *Fresh Hearts that Failed Three Thousand Years Ago*; and *A Story of Two from an Old Dutch Town*. His most meritorious work, however, is a novel of Newfoundland life, told with much ability and delicacy of thought and expression, and called *The New Priest of Conception Bay*.

G. MERCER ADAM.

LOWELL, JOHN, an American statesman; born in Newburyport, Massachusetts, June 17, 1743. He graduated from Harvard in 1760; was admitted to the Massachusetts bar in 1762, and was elected a member of the legislature from Boston in 1778. As a member of the convention that framed the Massachusetts constitution, he caused the words "all men are born free and equal" to be inserted in it, a first blow to the institution of slavery. As a consequence, in 1783, slavery was abolished in Massachusetts. In 1782-83 he was a member of the Continental Congress, and in 1784 was one of the commission to decide boundary disputes between New York and Massachusetts. In 1789 he was made United States judge for his state, and in 1801 became chief justice of the first circuit, including Maine, New Hampshire, Massachusetts and Rhode Island. He was one of the founders of the American Academy of Sciences and Art. He died in Roxbury, May 6, 1802.—Of his three sons, JOHN, FRANCIS CABOT and CHARLES, all were distinguished in their way. Francis Cabot's name has passed to posterity as that of the founder of the city of Lowell. He was born in Newburyport, April 7, 1775. He had visited England (1810-12) for the purpose of studying the cotton-manufacturing industry in the old country; he returned, convinced that New England could be made a center of cotton spinning and weaving. In 1816 he induced Congress to pass a law imposing a heavy duty upon imported cotton goods, and was soon ready to supply the demand of the trade with home-made fabrics. He died in Boston, Aug. 10, 1817.—His son, JOHN, an American philanthropist, was born in Boston, May 11, 1799. He spent most of his life traveling in various parts of the world and collecting a very fine library. In his will he bequeathed \$250,000 for the maintenance, in Boston, of courses of free lectures on religion, science and

the arts. These have been delivered yearly ever since, in what is called the Lowell Institute, Boston. He died in Bombay, India, March 4, 1836.

LOWELL, PERCIVAL, an American writer; born in Boston, March 13, 1855; graduated from Harvard University in 1876. He traveled much in the far East. While in Japan, in 1883, he was appointed Foreign Secretary and Counselor to the Korean Special Mission to the United States. He returned to Korea the same year, and spent the winter in Séoul, its capital. He devoted his wealth and time to the study of Mars, and for this purpose built an observatory 7,000 feet above the sea at Flagstaff, Arizona. He wrote *Choson, a Sketch of Korea* (1885); *The Soul of the Far East* (1888); *Nota, an Unexplored Corner of Japan* (1889); and a number of poems.

LOWTHER, JAMES, an English statesman; born near Leeds, England, in 1840; graduated at Trinity College, Cambridge, in 1862; called to the bar at the Inner Temple in 1864; elected a member of Parliament for York as a Conservative in 1865; continued to sit for that city until 1880; elected member for North Lincolnshire in 1881, which he represented until 1885. Under-Secretary of State for the colonies (1874-78); Chief Secretary of Ireland in 1874, which office he held until the resignation of Lord Beaconsfield's government in May, 1880. He failed to re-enter Parliament in 1885 and 1886, but was returned by a Kentish division in 1888 and 1892. He is well known as a successful sportsman and horse-breeder.

LOWVILLE, a post village and the capital of Lewis County, northern central New York, 25 miles S.E. of Watertown, on the Rome, Watertown and Ogdensburg railroad, and 1½ miles W. of the Black River, in a rich agricultural region producing cheese, butter, hops and lumber. The village contains a noted academy, founded in 1808, and also foundries and mills, water-works and electric lights. Population 1900, 2,352.

LOXA. See LOJA, Vol. XIV, p. 809.

LOYAL TEMPERANCE LEGION. See WOMAN'S CHRISTIAN TEMPERANCE UNION, in these Supplements.

LOYSON, CHARLES, a French divine, formerly known under the monastic name of Père Hyacinthe; born at Orleans, France, March 10, 1827. Studied theology at St. Sulpice, Paris, and in 1851 was ordained priest; taught philosophy and theology at Avignon and Nantes. Subsequently entering the order of Barefoot Carmelites, he became known as a powerful preacher, attracting crowded audiences of all ranks of society to the Madeleine and Notre Dame, in Paris. Almost as remarkable as his eloquence was the boldness with which he denounced existing abuses in the church, and in 1869 the general of his order imposed silence on him. Hyacinthe replied by a letter, in which he called for a thorough reform of the church, and was excommunicated by the pope. He then preached independently, resuming his family name, Loyson. In 1869 he visited the United States, and on his return married in London an American widow. He was afterward for a short time curé of a congregation of Liberal Catholics at Geneva, Switzerland, and in 1879 established an in-

dependent congregation in Paris under the name *L'Église Gallicane*. This attempt was kept alive by funds subscribed in England, America, and among French Protestants; but it never prospered, and is said to have been abandoned. He has published a number of sermons and lectures, the best known being *La Société Civile dans ses Rapports avec le Christianisme* (1867), signed Père Hyacinthe, and *Ni Cléricaux, Ni Athées* (1890).

LUALABA, a river of Africa. See AFRICA, Vol. I, p. 248.

LUAPULA, a river of Africa. See ZAIRE, Vol. XXIV, p. 763.

LUBBOCK, SIR JOHN, English banker, Parliamentarian and scientist, was born in London, April 30, 1834. He was the son of Sir J. W. Lubbock

(1803-65), the astronomer and mathematician, and when 14 years of age entered his father's banking-house, and in 1856 became a partner. He was chosen honorary secretary to the Association of London Bankers, first president of the Institute of Bankers, and served on the International Coinage Commission, as a member of the



SIR JOHN LUBBOCK.

Public School Commission, the Advancement of Science Commission, the Education Commission and the Gold and Silver Commission. In 1870 he was returned for Maidstone, and, on losing his seat in 1880, was returned for London University—since 1886 as a Liberal Unionist. As a politician he devoted himself chiefly to financial and educational subjects, and succeeded in passing more than a dozen important public measures, including the Bank Holidays Act, the Bills of Exchange Bill (which regulates the whole law relating to checks, bills and promissory notes), and the Shop-hours Bill. He was vice-chancellor of the University of London from 1872 to 1880; a trustee of the British Museum; in 1881 president of the British Association for the Advancement of Science; president of the London Chamber of Commerce, and chairman of the London County Council. He has written many original scientific works, which have had a phenomenal sale. Among them are *Prehistoric Times* (1865), as illustrated by ancient remains and the manners and customs of modern savages; *The Origin of Civilization and Primitive Condition of Man* (1870), dealing with the mental and social aspect of savages; *The Races of the British Isles* (1887), a reprint of letters to the *London Times*; *Scientific Lectures* (1879), a brochure on *Representation* (1885), in the Imperial Parliament Series; *Fifty Years of Science* (1881), a British Science Association address; *Addresses: Political and Educational* (1879); three volumes in the Nature Series: *On the Origin and Metamorphoses of Insects* (1873); *On British Wild Flowers in Relation to Insects* (1875); and *Flowers, Fruit and Leaves* (1886). In 1882 he published a volume in the International Scientific Series, on *Ants, Bees and Wasps*. An-

other volume, which also appeared in the International Scientific Series, is *On the Senses, Instincts and Intelligence of Animals, with Special Reference to Insects* (1889). He also wrote *A Contribution to the Knowledge of Seedlings* (2 vols., 1892). He published a series of essays of an entertaining character, the first of which, entitled *The Pleasures of Life* (1887), had myriads of readers. The others of the series, in the order of their appearing, are *The Beauties of Nature and the Wonders of the World We Live In* (1892), and *The Use of Life* (1895). To these he added *The Scenery of Switzerland* (1896).

LUBBOCK, SIR JOHN WILLIAM, BARONET, an English scientist, father of the preceding; born in London, England, April 26, 1803; died June 20, 1865; received the A.M. degree from Trinity, Cambridge, in 1825; elected a fellow of the Royal Society in 1829; was a very successful banker, although giving much of his time to astronomy and natural history. He wrote *Researches on Physical Astronomy* (1830); *Classification of Branches of Human Knowledge* (1838); besides a number of papers on *Tides*; *Eclipses*; *Lunar and Planetary Perturbations*; etc.

LÜBECK, a free city and state of the German Empire. The official reports for 1895 give the area at 115 square miles and the population at 82,813, of whom 97.5 per cent were Protestants and 1.2 Catholics. The estimated revenue in 1895 amounted to 4,299,933 marks, and the expenditures to 4,616,194. Of the revenue, about one sixth is from public domains, chiefly forests; one fourth from interest, and the rest from taxation. One fourth of the expenditures is for interest on, and reduction of, the public debt, which was 19,597,621 marks. Population of the city of Lübeck in 1895, 69,874. See LÜBECK, Vol. XV, pp. 31-34.

LÜBKE, WILHELM VON, a German art historian; born at Dortmund, Westphalia, Jan. 17, 1826. After studying at Bonn and Berlin, he soon attracted attention by his articles on the history of art, published in the *Deutsche Kunstblatt*, which caused him to be appointed professor of the history of architecture in the Berlin School of Architecture. He made several journeys in Italy, France, and Belgium for the purpose of studying church architecture. In 1861 he became professor of archaeology and the history of art in the Polytechnic School at Zürich, and in 1866 at Stuttgart. Finally he settled at Karlsruhe as professor at the Superior Technical School and director of the Grand Duke of Baden's picture-gallery. Among his chief works are *Geschichte der Plastik* (2d ed., 1870); *Grundriss der Kunstgeschichte* (7th ed., 1875); *Geschichte der Architektur* (6th ed., 1884). His *History of Art* was translated into English and published in the United States in 1880. Died in Karlsruhe, April 5, 1893.

LUBRICATOR. The Holmes fiber-graphite lubricator was introduced in 1891, and was the first successful substitute for an oil-lubricant. It is composed of graphite and wet wood-pulp molded into form and used as a bearing with a metal support. The materials are united with a drying-oil, and the graphite does the lubricating, while the fiber of the wood-pulp serves to keep it in form. It does not heat readily, and the ratio of friction is less than

with the average well-oiled bearing. It has been found especially useful in spinning-machinery, where the spindles involve the use of a great number of bearings, the oiling of which requires much time and causes waste. A spindle may be rotated at a speed of 8,400 rotations a minute, without heating, with a bearing made of this lubricator.

Lubricators for steam-pipes commonly consist of an oil-chamber, into which a minute quantity of steam is allowed to pass, in order to force the oil out, drop by drop, through the connections into the steam-pipes. The best forms have a glass tube, called a sight-feed, through which the oil may be seen passing, a drop at a time, and the engineer is thus able to note and regulate the amount of oil supplied.

C. H. COCHRANE.

LUCAN, GEORGE CHARLES BINGHAM, EARL OF, a British general; born in London, April 16, 1800. He was educated at Westminster; entered the army in 1816; accompanied the Russian troops under General Diebitsch as a volunteer against the Turks in 1828; succeeded to a title and large estates in Ireland in 1839; as commander of a division of cavalry in the Crimea, fought at the Alma, Balaklava (where he led the "charge of the Light Brigade" Oct. 25, 1854) and at Inkermann. Appointed lieutenant-general in 1858 and G.C.B. in 1869, he became field-marshal in 1887. He died Nov. 10, 1888.

LUCARIS, CYRIL. See GREEK CHURCH, Vol. XI, p. 158.

LUCAS, JOHN SEYMOUR, an English artist; born in London, Dec. 21, 1849. Starting in his chosen profession at the age of 15, he spent three months in the studio of a sculptor, and nine months with Gerard Robinson, the wood-carver, from whom he received his first notions of composition. His uncle then placed him in the studio of his son, John Templeton Lucas, while the young pupil also attended the evening classes of the St. Martin's School of Art, in connection with South Kensington Museum. In 1871 he became a student of the Royal Academy, exhibiting his first picture there in 1872. In 1875 he had his first painting, entitled *By Hook or Crook*, exhibited at Burlington House. The following year he sent two pictures, *Fleeced*, and *For the King and the Cause*; and in 1877 *Intercepted Dispatches. An Ambuscade: Edge Hill* appeared in 1878. The technical merit of all this artist's work is of a high order, especially noticeable in *The Gordon Riots*, exhibited in 1879. In 1877 he was elected full member of the Institute of Painters in Water-Colors, and in 1886 was elected an associate royal academician. Others of his works are *The Armada in Sight* (1880); *Charles Before Gloucester* (1881); *The Favorite* (1882); *A Whip for Van Tromp* (1883); *After Culloden* (1884); *From the Field of Sedgemoor* (1885); and *Peter the Great at Deptford* (1886).

LUCAYAS, same as BAHAMAS, Vol. III, p. 236.

LUCCA, PAULINE. See WALLHOFEN, MADAME PAULINE, in these Supplements.

LUCE, AUGUSTE SIMÉON, a French historian; born at Bretteville, Manche, France, Dec. 29, 1833;

graduated as doctor of letters in 1860; recorder of the archives of Deux-Sèvres department, he became deeply interested in historical researches, for which he had prepared himself by graduating from the *École des Chartes*; appointed chief of the historical section of the national archives in 1866, and in 1885 professor of the authorities of French history at the *École des Chartes*; member of the Institute in 1882. He wrote *Histoire de la Jacquerie* (1859); *Histoire de Bertrand Duguesclin* (1876), which received from the Academy the first Gobert prize; *Jeanne d'Arc à Domrémy* (2d ed., 1887); *La France Pendant la Guerre de Cent-Ans* (1890). He also prepared several ancient books and manuscripts for publication, with notes. Died in Paris, Dec. 15, 1892.

LUCE, STEPHEN BLEECKER, an American sailor; born March 25, 1827; entered the United States navy as midshipman in 1841; commissioned lieutenant in 1855; lieutenant-commander, 1862; commander, 1866; captain, 1872; commodore, 1881; rear-admiral, 1885; retired 1889. During the Civil War he distinguished himself as commander of the *Nantucket* in 1863 and the *Pontiac* in 1864-65; president of the United States Naval College in 1884-86; founded the United States Naval War College, and aided in organizing the present United States naval training-system. He wrote *Seamanship* (1863) and *Naval Songs* (1883).

LUCERNE or PURPLE MEDICK. See AGRICULTURE, Vol. I, p. 378.

LUCIGEN. An oil-lamp in which a large flame and consequent brilliancy is obtained by spraying the oil with air. It consists of a small tank with a drop-pipe to the burner. The latter has a superheating device, consisting of a small tube-coil, in which the oil flows around the burner, so that it is quite hot by the time it escapes. A compressed-air pipe supplies the draft for spraying, and a trap carries off the moisture.

LUCRETIA. The tragic death of this Roman matron formed the subject of Shakespeare's *Rape of Lucrece*. See TARQUINIUS SUPERBUS, Vol. XXIII.

LUCY, HENRY W., an English journalist; born near Liverpool, Dec. 5, 1845; joined the staff of the *Shrewsbury Chronicle* as chief reporter in 1864; in 1869 was a student at the Sorbonne, Paris; in 1870 returned to London to join the staff of *The Pall Mall Gazette*; and in 1873 joined *The Daily News* as special correspondent, chief of the gallery staff, and writer of the Parliamentary summary. He wrote *A Handbook of Parliamentary Procedure* and *Men and Manners in Parliament*. He contributed the weekly "Diary of Toby, M. P.," in the *London Punch*. In 1882 his first novel, *Gideon Fleyce*, was published, and in January, 1886, he became the editor of the *Daily News*.

LUDERS, ALEXANDER NICOLAJEVICH, COUNT, a Russian soldier; born Jan. 26, 1790, of a German family settled in Russia; entered the army in 1807; served in the war against Napoleon; became brigadier-general in 1826; distinguished himself during the Polish insurrection of 1831; defeated the Circassian leader Schamyl, 1843-45, and captured Dargo. Helped subdue the revolutions in Roumania in 1848, and Hungary in 1849; was commander-in-chief at Sebastopol when captured by the Franco-English troops; when lieutenant-general of Poland in 1861-62,

his rule was so harsh as to cause his recall, not, however, before he had been wounded in an attempt at assassination. He soon retired from service, and was made a count. Died in St. Petersburg, Feb. 13, 1874.

LUDINGTON, city, capital of Mason Co., Mich., on Lake Michigan, at the mouth of Père Marquette river; is connected with Milwaukee, 84 miles S. W., by a steamer line; is in a fruit-raising region; has a good harbor, manufactures shingles, woodwork, salt, iron-work, and carriages, and has a foundry and machine-shop. Population 1890, 7,517; 1900, 7,166.

LUDLOW, a post village in Windsor Co., Vt., on Black River, 25 miles S. S. E. of Rutland; has an academy, a foundry, and factories of woolen goods, carriages, toys, and machinery. Pop. 1900, 1,454.

LUDLOW, JAMES MEEKER, an American clergyman and author; born in Elizabeth, N. J., March 15, 1841; graduated at Princeton College and Seminary; pastor of the First Presbyterian Church at Albany, N. Y. (1865-69); of the Collegiate Reformed Dutch Church at New York (1869-77); of the Westminster Presbyterian Church, Brooklyn, N. Y. (1877-86); and of the First Presbyterian Church, East Orange, N. J. (1886). Wrote *The Captain of the Janizaries* (1886); *A King of Tyre* (1891); *That Angelic Woman* (1891); and compiled a *Concentric Chart of History* (1885).

LUDLOW, WILLIAM, American officer of engineers, born in Oakdale, Long Island, Nov. 27, 1843. On July 1, 1860, he was appointed, from the state of New York, cadet at the Military Academy; and he graduated therefrom on June 13, 1864, on which date he entered the regular army as first lieutenant in the engineers, and later joined Sherman on his march to the sea. On July 20, 1864, he was made brevet captain for gallant services during the campaign in northern Georgia; on Dec. 21, 1864, he was made brevet major for meritorious services in the campaign through Georgia in Sept.-Dec., 1864; and on March 13, 1865, he was made brevet lieutenant-colonel for faithful conduct in the campaign in the Carolinas. He was promoted captain on March 7, 1867; major on June 30, 1887; and lieutenant-colonel on Aug. 13, 1895. In 1897 he was a member of the commission appointed by Congress to investigate and report on the construction of a Trans-Isthmian canal. After the war with Spain broke out in April, 1898, he was made brigadier-general of volunteers; and he was in command of the engineers at the siege and capture of Santiago de Cuba in June-July, 1898. On July 8 he was made major-general of volunteers, and in December he was appointed military governor of Havana.

LUDWIG, KARI FRIEDRICH WILHELM, a German physiologist; born at Witzenhausen, Hesse, Dec. 29, 1816; appointed professor of comparative anatomy at Marburg in 1846; professor of physiology at Zürich (1849-55); at Vienna (1855); and at Leipsic (1865). His investigations in anatomical physiology place him in the front rank of that department of science. His chief work is *Lehrbuch der Physiologie des Menschen* (1852-55); but his *Arbeiten aus der Physiologischen Anstalt zu Leipzig* and his essays contain valuable contributions to physiology. Died April 25, 1895.

LUDWIG, OTTO, a German playwright and Shakespearean scholar; born at Eislefeld, Saxe-Meiningen, Feb. 11, 1813. After beginning the study

of music and receiving instruction from Mendelssohn in Leipsic, his ill-health compelled him to devote himself solely to literature. The influence of his thorough study of Shakespeare was visible in his three powerful tragedies, *Der Erbförster* (1853); *Die Makkabäer* (1854); and *Agnes Bernauer* (1857), which were received enthusiastically. An excellent series of exhaustive Shakespearean criticisms is contained in his *Shakespeare Studien* (1871), and his novel *Zwischen Himmel und Erde* (1856) ranks high in German fiction. Died in Dresden, Feb. 25, 1865.

LUGARD, SIR EDWARD, an English soldier; born in Chelsea, England, in 1810. Having entered the army in 1828 from Sandhurst Military College, he joined the Indian Army. During the Afghan war of 1842 he was brigade-major of the fourth brigade; and during the Sikh war of 1845-46, assistant adjutant-general of the first division. Throughout the Punjab campaigns of 1848-49 he was adjutant-general. He was made K. C. B. for his services as chief of the staff in the Persian expedition of 1856-57, and adjutant-general in India in 1857. At the capture of Lucknow he commanded the second division of infantry, and was made major-general in 1858. In 1861-71 he was permanent Under-Secretary of War. He was made lieutenant-general in 1872, and was a Privy Councillor from 1871. Died Oct. 31, 1898.—His nephew, FREDERICK D.

LUGARD, an English soldier and writer, was born in Madras in 1858, and from Sandhurst entered the Indian Army in 1879. He distinguished himself as transport officer to the Ruby Mines column in Burma, succeeding in bringing troops, artillery, and supplies over mountains 8,000 feet high. Placed on sick-leave, he was appointed Uganda agent of the British East-African Company, and in 1893 published an admirable book, *The Rise of Our East-African Empire*. In 1894-95 he commanded an expedition to Borgu to negotiate treaties; and in 1896-97 an expedition to Lake Ngami.

LUGWORM. See ANNELIDA, Vol. II, p. 71.

LUITPOLD, PRINCE CHARLES JOSEPH WILLIAM, regent of Bavaria; born at Würzburg, Bavaria, March 12, 1821. He became general and inspector-general of the Bavarian army. He married April 15, 1844, the Princess Augusta, Archduchess of Austria. During the reign of King Louis II he was at the head of the ultra-Catholic and anti-Liberal party. When the king's eccentricities grew to outright insanity, Prince Luitpold was placed at the head of affairs as regent. On the death of King Louis II in June, 1886, Prince Luitpold continued to perform the functions of regent on account of the mental derangement of Otto, the succeeding titular king.

LUMBY, JOSEPH RAWSON, an English clergyman and writer of ecclesiastical history; born at Staningley, Yorkshire; graduated in the first class of the classical tripos from Magdalene College, Cambridge, in 1858; elected a fellow and soon after a lecturer in his own college; appointed Norrisonian professor of divinity at Cambridge in 1879, and was one of the founders of the early English Text Society. He published, for the Pitt Press, *Bacon's Life of Henry VII*; *More's Utopia*; and books 3

and 4 of *Beda's Ecclesiastical History*; wrote a *History of the Creeds*, and published, in 1893, the *Cambridge Companion to the Bible*. He contributed to this ENCYCLOPÆDIA. He died Nov. 21, 1895.

LUMMIS, CHARLES F., an American traveler and ethnologist; born in Massachusetts, and graduated at Harvard; settled in Ohio in 1882; walked from there to California (3,250 miles), and narrated his experiences during this novel kind of a pleasure-trip in his *Tramp Across the Continent*, a successful book of genuine adventure; settled in Los Angeles, California, as owner and editor of the *Los Angeles Times*; on account of ill health, he decided to live an open-air life among the Pueblo Indians, and explored thoroughly, first New Mexico, and later, in 1892, Peru and Bolivia. Among his books, well received by the public, are *A New Mexico David*; *Some Strange Corners of Our Country*; *The Land of Poco Tiempo*; *The Spanish Pioneers*; *The Man Who Married the Moon* (Pueblo Indian folk-lore); *The Gold Fish of Gran Chimú* (a Peruvian tale); and *Mexico To-day* (1898). In 1895 he became editor of a Los Angeles monthly, *The Land of Sunshine*.

LUMPKIN, a village and the capital of Stewart County, southwestern Georgia, 30 miles S.S.E. of Columbus, on Hoachookee Creek, and on the Georgia and Alabama railroad. It has a Masonic college for women. Vehicles and leather are manufactured, and flour, cotton, corn, sweet potatoes and pork are the principal products of the neighborhood. Population 1900, 1,470.

LUMPKIN, JOSEPH HENRY, an American jurist; born in Oglethorpe County, Georgia, Dec. 23, 1799. He graduated at Princeton in 1819, was admitted to the bar in 1820, and quickly gained prominence in his profession. In 1844 he retired on account of ill health, and traveled through Europe; on his return in 1845, he was elected successively justice and chief justice of the supreme court of Georgia; lectured as professor in the law school of Georgia University, where he founded the Lumpkin Law School, but declined all other offices, Federal and state. He was one of the compilers of the Penal Code of Georgia in 1833, and maintained the highest place on the bench of his state. He died in Athens, Georgia, June 4, 1867.

LUMSDEN, SIR PETER STARK, a British soldier; born at Aberdeen, Scotland, in 1829; entered the Indian army in 1847, and in 1857 he was employed in a difficult mission to Afghanistan, at the crisis of the Indian Mutiny, and discharged his perilous duties with credit. He accompanied the expedition to China in 1860, and was present in all the actions there, including the assault and capture of the Taku forts. He was adjutant-general to the commander-in-chief, Sir F. P. Haines, during the last Afghan war, and was appointed commissioner for the demarcation of the northwestern boundary of Afghanistan in 1884. He attained the rank of general in 1890, joined the Indian staff the same year; appointed a member of the Council of India, and was made a G. C. B. in 1885.

LUNA, ALVARO DE. See SPAIN, Vol. XXII, p. 321.

LUNACY. See INSANITY, Vol. XIII, p. 95.

**LUNA-MOTH** (*Actias luna*), a large moth, said to be the most beautiful North American insect. The wings are of a delicate green color, with beautiful eye-spots. The hind wings have a long tail. The full-grown caterpillar is bluish green, with yellow markings. The caterpillar known as the luna silkworm, feeds on the foliage of many native forest-trees. It produces silk of fine quality, but which cannot be reeled.

**LUND, JOHANN REINHOLD**, a German-American musician; born in Hamburg, Germany, Oct. 20, 1859; educated at the Leipsic Conservatory; emigrated to the United States in 1884, as assistant musical director of the German Opera Company, and directed the Orpheus Singing Society and the Symphony Orchestra in Buffalo, New York.

**LUNDY**, an island in the mouth of the Bristol Channel, nearly facing the center of Barnstaple Bay, and 12 miles N.N.W. of Hartland Point, Devonshire, England. It is 2½ miles long by 1 mile broad, and has an area of 1,200 acres. Precipitous granite cliffs allow but one landing-place, on the eastern side, and even here only in a smooth sea. The Trinity Board maintains a lighthouse at the south end of the island, in lat. 51° 10" N., long. 4° 40" W., with lights of the first-class order, 567 feet above the sea, and visible 31 and 28 miles. In early days Lundy was a bone of contention between England and Wales. Drayton (q.v., Vol. VII, p. 452) devotes two cantos of *Polyolbion* to the question—

"England and Wales strive in this song,  
To whether Lundy doth belong."

Local tradition is rich in legends of the Danes. Hubba, the Danish invader, defeated at the battle of Kenwith Castle, near Appledore, in 894, is said to have been buried in Lundy,

"With shore and wave to share his corse,  
A very Dane in death."

The ruins of Marisco's Castle, the stronghold of a pirate of the time of Henry III, are to be seen. This castle was held for King Charles I in the Civil War by Lord Say and Sele.

In colonial days, one Thomas Benson, who held the contract for the exportation of convicts to Virginia and Maryland, obtained possession of Lundy, and employed the convicts on the island until the government interfered and compelled him to transport them to the colonies.

Though part of the county of Devon, the island has been a parish to itself since 1225, and in monastic days boasted of a church dedicated to St. Helena, the ruins of which are still visible, and near which an iron church was erected in 1889. Its 53 inhabitants are tenants of the Rev. W. C. Heaven, the freeholder of the entire island, who acts as pastor, doctor, lawyer and policeman; for the island lacks these functionaries. There is excellent grazing for a small herd of cattle, and Lundy butter is as well known as the isle. Sea-birds, including the solan-goose, nest in myriads on its secluded cliffs, and many a human toiler, wearied of the rattle of the city, comes here for absolute repose. Lundy, hanging like a soft gray cloud on the horizon of the North Devon coast, has been celebrated in the stirring prose of the Rev. Charles Kingsley

(q.v., Vol. XIV, p. 88). On its dreaded Shutter Rock, still the Scylla to its Hen and Chickens' Reef, the unwieldy galleon of the Armada struck and sank. Seated on its majestic cliffs, blind Amyas Leigh, the courtly hero of *Westward Ho!* brooded over his wrongs and found a nobler peace of mind. The island has been well described, also, in J. R. Chanter's *Lundy Island: A Monograph, Descriptive and Historical* (1877). It is reached by a sloop from Instow in fair weather, and is an important signal-station in the manœuvres of the Channel fleet.

**LUNDY, BENJAMIN**, an American philanthropist; born in Hardwich, New Jersey, Jan. 4, 1789, of a Quaker family. As a lad he was apprenticed to a saddler at Wheeling, Virginia, and the sight of the cruel treatment to which the slaves were subjected made him an abolitionist for life. In 1815 he organized an antislavery association at St. Clairsville, Ohio, which in a few months grew from five to five hundred members. In 1822 he began the publication of the Mount Pleasant *Genius of Universal Emancipation*, a monthly. In 1824 he removed his paper (now a weekly) to Baltimore, then to Washington, and finally to Philadelphia. He made several lecturing tours through the states, on foot, preaching indefatigably the doctrine of emancipation, and attempted to establish, in Hayti, colonies of freed slaves, from 1825 to 1829; several times he was assaulted by slave dealers and was nearly killed in 1828; all his belongings were burned in the destruction, by the hand of an incendiary, of Pennsylvania Hall, Philadelphia. He had but recently settled in Illinois when he died, so to speak, "in harness," in Lowell, Oct. 22, 1839.

**LUNDY'S LANE, BATTLE OF**, won by the American troops under General Jacob Brown over the British troops under General Riall, July 24, 1814. Brigadier-General Winfield Scott, in command of the left wing of Brown's army, while on the way to assail Queenston, near the Niagara frontier, came upon the British, posted along Lundy's Lane, and a conflict ensued that lasted from the middle of the afternoon till midnight, the British troops being everywhere repulsed. Generals Brown and Scott were wounded, and the command devolved upon General Ripley, who withdrew from the field, and the British recovered their position next day. The losses were about even, nine hundred men on each side.

**LUNE**. See **MENSURATION**, Vol. XVI, pp. 19, 25.

**LUNEL**, a town in central southern France, 14 miles N.E. of Montpellier, with a trade in Muscatel wine and brandy. Interesting human remains have been found in a cave at Pondres, six miles north of Lunel. Population, 6,460.

**LUNG CHOW**, a walled city of the province of Kwangsi, central southern China, on the Tso-Kiang, at the confluence of the Sungchi-Kiang and the Kooping-ho. It was opened to foreign commerce June 1, 1889, by treaty. Population, about 20,000.

**LUNGS**. See **RESPIRATION**, Vol. XX., pp. 475, 476.

**LUNGWORT**, a common name given to species of *Mertensia*, a genus of the family *Boraginaceæ*. They

are herbs, with tubular or trumpet-shaped flowers. The common species of the eastern United States is *M. Virginica*, a very smooth plant, with flowers purple in bud, but bright blue when open.

LUPULIN OR LUPULITE. See HOP, Vol. XII, p. 157.

LUPUS. See SKIN DISEASES, Vol. XXII, pp. 121, 122.

LUPUS SERVATUS. See LIBRARIES, Vol. XIV, p. 513.

LURAY, a village and the capital of Page County, northern Virginia, 78 miles W. of Washington, District of Columbia, on the Norfolk and Western railroad. It is in the picturesque valley of the south fork of the Shenandoah, and on this account, and because of the famous Luray Cavern (q.v., Vol. XV, pp. 67, 68) it has become a very popular summer and tourist resort. It has two girls' seminaries, an academy, woolen factories and a tannery. Population 1900, 1,147.

LUSHINGTON, STEPHEN, an English jurist; born in London, England, Jan. 14, 1782. He was educated at Eton, and graduated at Oxford; called to the bar in 1806, entered practice in the Doctors' Commons as an advocate in 1808; judge of the Consistory Court in 1828; judge of the Admiralty Court in 1838. He sat in Parliament at different times, as a Liberal, from 1807 to 1831; was one of the council for Queen Caroline in the famous divorce suit in 1820; took sides with Lady Byron against her husband. He retired from the bench in 1867 and died Jan. 19, 1873.

LUSITANIA. See PORTUGAL, Vol. XIX, p. 539.

LUSK, WILLIAM THOMPSON, an American physician and surgeon; born at Norwich, Connecticut, May 23, 1838; remained one year at Yale, and then went to Heidelberg and Berlin to study medicine (1858-61); served in the Union army from 1861 to 1863; received his M.D. from Bellevue Hospital Medical College in 1864; pursued post-graduate studies in Edinburgh, Paris, Vienna and Prague; returned to New York City in 1865 and began practicing, making a specialty of obstetrics and diseases of women; was lecturer on physiology at Harvard (1871); professor of obstetrics and diseases of women in Bellevue Hospital Medical College (1871); and visiting physician at the same hospital (1871); co-editor of the *New York Medical Journal* (1871-72). His most important book, *The Science and Art of Midwifery* (1882), has gone through many editions in several languages. Died June 12, 1897.

LUSSAN, RAVENEAU DE, a French buccaneer; born in Paris in 1663. He was of good family, and at the age of 14 entered on a military career. In 1679 he went to Santo Domingo in quest of adventure, and joined the buccaneers under the Dutch corsair, Cornelius Laurent. In the following year he formed a band of his own to act against the Spaniards, and pillaged the town of Realejo, in Guatemala. In 1686 his band set fire to Grenada, and later took part in the capture of Guayaquil. Afterward his band of about three hundred men captured Tehuantepec. At Nueva Segovia, his men, having made a journey overland, were surrounded and

hemmed in by the Spaniards, but, favored by fog, found their way to the rear of the intrenched Spaniards and put them to flight. This retreat of a handful of men over one thousand miles of wild country, and through dangers innumerable, is considered one of the most marvelous feats of that time. After much suffering and frequent hazards, Lussan reached France and published his *Journal du Voyage fait à la Mer du Sud avec les Flibustiers de l'Amérique* (Paris, 1688). It was dedicated to the Minister of the Navy, and by him and the nation at large was well received. He died in France about 1710.

LUSSIN, a long, narrow island in the Adriatic, belonging to the government of Dalmatia, Austria, 20 miles long and 3 broad. It is situated just to the southeast of the entrance of the Gulf of Quarnero. Its inhabitants are engaged in agriculture, fishing and commerce. The city of Lussin-Piccolo, on the east side, has a population of 4,975; a good harbor, capable of accommodating the largest vessels, and has a large trade in wheat, wine, olive-oil, fruit, etc. Population of the island, 11,848.

LUTHERAN CHURCH IN THE UNITED STATES. The earliest Lutheran immigrants to the United States came from Holland and settled in New Amsterdam about 1624, but it was not till 1664, when New York came under the control of the British, that they were allowed to call a minister or open a separate church. Congregations extended along the Hudson, and in New Jersey. The first actual Lutheran church in America was established in 1637, on the banks of the Delaware, by Swedish immigrants, who came over under the patronage of Axel Oxenstiern, the Prime Minister and successor of Gustavus Adolphus. Churches were erected at Christiana, Delaware, and at Wicaco, Philadelphia, where the "Old Swedes" Church is still in existence. Most of these early Swedish Lutherans, after the Revolutionary War, joined the Protestant Episcopal Church. German Lutherans first came to America about 1680, but not till 1708 did they begin to found congregations, first at Newburg, New York, and at Newberne, North Carolina, a couple of years later. German Lutheran emigration was encouraged by Queen Anne, who, in 1709, gave 2,100 acres of land in New York to some 3,000 German colonists "for the maintenance of Lutheran parish schools and ministers," and by William Penn, whose liberal policy induced many poor but pious Lutherans from Germany to settle in Pennsylvania. A body of Tyrolese (Swiss) Lutherans followed in 1734, and settled at Ebenezer, Georgia. The first pastor of the German Lutheran Church in America was Henry Melchior Muhlenberg, the "patriarch of the Lutheran Church in America," who came over in 1742. The early Lutherans settling in America were thoroughly imbued with the spirit of religious freedom then struggling for expression, and, while they held strictly to the general doctrine of the parent church, were liberal in its interpretation, and favored a broad ecclesiastical polity. According to the *Bibliotheca Sacra*, they "encouraged and practiced the most enlarged catholicity of spirit and action among evangelical churches. Most kindly

relations existed between Lutherans, Presbyterians, Episcopalians and others." Muhlenberg and Whitefield associated in church labors with fraternal comity. But the large influx of Lutheran immigrants, mainly from Germany and Scandinavia, which began in the early part of the nineteenth century, founding congregations often served by local pastors who lacked the broad training of the schools, developed a spirit of strict conformity and adherence to ancient liturgical uses. This policy resulted in disagreements, in separation of churches and districts, and in the founding of independent and non-affiliating bodies, each striving to embody its own ideas of true Lutheranism as it understood the symbols.

The first Lutheran synod was organized in Philadelphia, Aug. 14, 1748, and comprised both German and Swedish pastors. A second synod was organized in New York in 1785, these bodies being composed of the pastors of the district, together with an equal number of lay delegates appointed by the congregations. They form an ecclesiastical body which decides questions pertaining to church fellowship, etc. In 1820 most of the synods then existing united in the General Synod of the Evangelical Lutheran Church, as an ecclesiastical body having only advisory powers. At the outbreak of the Civil War a separate general synod for the South was organized, which, in 1886, became the United Synod, representing, in 1895, an aggregate of 40,639 communicants. The General Synod advocates a liberal adherence to the Augsburg Confession. It maintains seminaries at Gettysburg and Selingsgrove, Pennsylvania; Hartwick, New York; Springfield, Ohio; and Chicago. Its adherents number about one eighth of all the Lutherans in the United States, and are mostly in purely English Lutheran Churches. The First Synod of Philadelphia, which had changed its name to the Evangelical Lutheran Ministerium of Philadelphia and Adjacent States, and had withdrawn from the General Synod, together with the independent synods of Pittsburg, Texas, Detroit, Ohio, Swedish Augustana and Northwest Synod, formed, in 1866, the General Council. Their seminaries at Philadelphia and Rock Island, Illinois, teach the unaltered Augsburg Confession in its original sense, strictly interpreted, favor a church polity approaching Presbyterianism and advocate fellowship with all Lutheran churches. The various churches connected with the General Council had, in 1895, 322,708 communicants.

In 1871, delegates from the synods of Missouri and Wisconsin, and independent synods from Minnesota, Illinois and Ohio organized the Synodical Conference. They require subscription to the symbolical books of the church as well as to the Augsburg Confession; forbid ecclesiastical intercourse with other religious denominations, including those Lutheran bodies which differ from them on points of "cardinal doctrine," and favor a church polity approaching pure Congregationalism. The Ohio and the Norwegian synods withdrew in 1881, on account of a dispute over the doctrine of predestination, while the synods of Michigan and the English Evangelical Lutheran Synod of Missouri and other states

were added. About 2,500 congregations and 480,000 communicants are represented in the Synodical Conference.

The largest independent union of Lutheran churches is the Missouri Synod, which originated in a colony of Lutheran "Pietists" or "Mystics" from Saxony, who settled in Perry County, Missouri, in 1839, and who had separated from the mother church on account of its rationalistic tendencies. Their first leader, Martin Stephan, proving unworthy, was banished from the settlement, and C. F. W. Walther of St. Louis, became their theological leader and teacher, remaining as such for more than forty-five years, or until his death in 1887. In 1847 the German Evangelical Lutheran Synod of Missouri, Ohio, and other states, was organized. It was based upon acceptance of all the symbols of the church; abstinence from every kind of syncretism, from mixed congregations and services; the use of purely Lutheran books in churches and schools, etc. It comprises 13 districts, extending from Canada to Texas, and is one of the most influential Lutheran bodies in American. It had, in 1896, 1,346 pastors and 1,015 congregations, with 370,246 communicants. It maintains theological seminaries at St. Louis, Missouri, and at Springfield, Illinois, besides colleges at Fort Wayne, Indiana; Addison, Illinois; Milwaukee, Wisconsin; St. Paul, Minnesota; Seward, Nebraska; Neperau, New York; and Lafayette, Missouri.

The growth of the various Lutheran bodies has been rapid. In 1880 there were 5,865 congregations, with an aggregate membership of 838,302. In 1895 there were 9,915 churches, with a total membership of 1,387,764. They maintain 25 theological seminaries, having, in 1895, 1,307 students; and 33 colleges, with an aggregate of 4,470 students. They sustain 39 orphan asylums, 7 old people's homes, 10 hospitals, and a number of other special eleemosynary institutions.

Among the later literature bearing upon the Lutheran Church in the United States are *Life and Times of Muhlenberg* (1887); *Bibliotheca Lutherana* (1876); *Geschichte der Evangelisch-Lutherischen Missouri Synode* (1885); *Lutheran Year-Book and Lutherische Kalender*; *History of Lutheran Church in the United States* (Jacobs, 1893); and *Geschichte der Lutherischen Kirche in Amerika* (Graebner, 1895). See also LUTHER, Vol. XV, p. 71; and LUTHERANS, Vol. XV, p. 84.

D. O. KELLOGG.

LUTHER LEAGUE OF AMERICA, an organization formed for the purpose of linking together the various young people's societies of the Lutheran churches, and "to encourage the formation of young people's societies in all the Lutheran congregations in America, to urge their affiliation with their respective state or territorial leagues, to stimulate to greater Christian activity and to foster the spirit of loyalty to the church." The league was first organized in New York City, in April, 1888. The first national convention of the league was held at Pittsburg, Pennsylvania, Oct. 30-31, 1895. Twenty states were represented, five of which had permanent



state organizations. The enrolled membership aggregated over 50,000.

LUTKE, FEDOR PETROVITCH, a Russian explorer; born in 1797. He was educated for the navy; in 1817-19 circumnavigated the globe; made four expeditions to Nova Zembla during 1821-24, and published a description of that region; explored and published descriptions of Bering Strait and Sea of Kamchatka (1836); was made an admiral in 1835. He was the founder of the Russian Geographical Society, and succeeded to Benjamin Franklin's seat in the French Institute. He died Aug. 20, 1882.

LUTTERWORTH, a small town of Leicestershire, on the Swift,  $6\frac{1}{2}$  miles N.N.E. of Rugby. The fine old church, restored by Scott in 1867-69, contains the pulpit and other relics of Wycliffe, who was rector from 1374 till his death, on Dec. 28, 1384. Population of parish, 1,965. See also WYCLIFFE, Vol. XXIV, pp. 709-711.

LÜTZEN, a small town of 3,501 inhabitants, in the Prussian province of Saxony, 12 miles S.W. of Leipzig; famous for two great battles fought in its vicinity. The first was a brilliant victory of the Swedes in the Thirty Years' War, which took place on Nov. 16, 1632, in which Gustavus Adolphus fell. The second battle was fought on May 2, 1813, somewhat farther to the south, at the village of Grossgörschen, and was the first great conflict of the united Russian and Prussian army with the army of Napoleon in that decisive campaign, the French remaining in possession of the field. See also FRANCE, Vol. IX, p. 617.

LÜTZOW, LUDWIG ADOLF WILHELM, FRIEDRICH VON, a German soldier; was born in Brandenburg, May 18, 1782. He was the organizer and leader of a celebrated corps of volunteers, called by his name, and recruited in Silesia during the German war of liberation of 1813. It included several celebrated men, as Jahn, Theodor Körner and others, and was renowned for its patriotism and courage. The men uniformed themselves, and were often sung and spoken of as the "Black Rifles" (*Schwarze Jäger*). He died in Berlin, Dec. 9, 1834.

LUVÉRNE, a village and the capital of Rock County, southwestern Minnesota, situated on Rock River, and on the Chicago, St. Paul, Minneapolis and Omaha and the Burlington, Cedar Rapids and Northern railroads. It is in an agricultural region, and has several building-stone quarries, several manufactories, and water and electric-light plants owned by the village. Population 1890, 1,466; 1900, 2,223.

LUXEMBURG, GRAND DUCHY OF, a state of Europe. In 1890, on the death of King William III, the grand duchy passed to Adolph, Duke of Nassau. It has a chamber of deputies of 45 members, elected directly by the cantons for six years, one-half being renewed every three years. It has an area of 998 square miles, and in 1890 had a population of 211,088, principally Roman Catholic. The capital, Luxemburg, has 18,187 inhabitants. The revenue for 1895 was 9,429,300 francs, and the expenditures were 8,837,765 francs. In 1893

the debt was 12,000,000 francs. For commercial purposes, Luxemburg is included in the German Zollverein. See also LUXEMBURG, Vol. XV, pp. 87, 88.

LUYNES, CHARLES D'ALBERT. See FRANCE, Vol. IX, pp. 567, 568.

LUYS JULES BERNARD, a French physician; born in Paris, Aug. 17, 1828; received his M.D. from the Paris School of Medicine in 1857; city hospital physician in 1862; physician-in-chief of the Ivry Sanatorium; elected a member of the Academy of Medicine in 1871. He made a speciality of the study and cure of nervous and brain diseases. His works include *Recherches sur le Système Nerveux Cérébro-Spinal* (1864, with 40 folio pages of drawings from life); *Iconographie Photographique des Centres Nerveux* (1872-74; illustrated); *Études de Physiologie et de Pathologie Cérébrale* (1874); *Le Cerveau et ses Fonctions* (3d ed., 1878; illustrated); *Traité Clinique et Pratique des Maladies Mentales*, received the Lallemand prize by the Academy of Medicine (1881); *Hypnotisme Expérimental* (1890). Died in Paris, Aug., 1897.

LUZERNE, ANNE CÉSAR, CHEVALIER DE LA, a French soldier and diplomatist; born in Paris in 1741; entered the army and distinguished himself during the Seven Years' War, in which he reached the rank of major-general in 1762, and was placed in command of the Royal Grenadiers. He entered diplomatic service as French minister, first to Bavaria, and in 1779 to the United States. In the latter capacity he spent four years in Philadelphia and never failed to show his sympathy for the young Republic. He even guaranteed a personal loan, much needed to furnish food for the troops in 1780; and in return he obtained, in 1782, the agreement that Congress should not ratify the treaty of peace with Great Britain until peace should be agreed upon between France and Great Britain. He returned to Europe in 1783, the bearer of many public testimonials of esteem. In 1789, the first Secretary of State of the Federal government was instructed by Washington to write to the Chevalier a letter of official thanks for services rendered. He was ambassador to the Court of St. James's, where he died Sept. 14, 1791.

LUZON. See PHILIPPINE ISLANDS, Vol. XVIII, pp. 748-751.

LUZULA, a genus of the family *Juncaceæ*, or rushes. The species are commonly known as wood-rushes, and are distinguished from the numerous species of *Juncus* by the one-celled and few-seeded pod, and the usually soft-hairy stems and leaves.

LUZZATTO, SAMUEL DAVID, a Hebrew scholar; born at Trieste, in Istria, Aug. 22, 1800. When only 15 years old he published a volume of Hebrew verses; in 1820 he was appointed professor of Biblical literature in the rabbinical college of Padua. Among the Hebrews in Italy, Luzzatto was celebrated for deep learning and wise judgment. He wrote against the Cabalists; published some volumes of Hebrew verse and several treatises and commentaries on Hebrew theology. He was preparing a version of the Old Testament in

Italian when he died, in Padua, Italy, Sept. 29, 1865.—His son, PHILOXENE LUZZATTO (1829-54), was distinguished as a linguist.

LYALL, EDNA. See BAYLY, ADA ELLEN, in these Supplements.

LYALL, SIR ALFRED COMYNS, an English statesman and writer; born at Coultston, Surrey, in 1835; educated at Eton; entered the Indian service; was successively Home Secretary in India in 1873; Foreign Secretary in 1878; Lieutenant-Governor of the Northwest Provinces in 1882; and member of the Council of India in 1888. He wrote *Asiatic Studies, Religious and Social* (1882); *Rise of the British Dominion in India* (1893); *Life of Warren Hastings*.

LYCEUM. See ATHENS, Vol. III, p. 2.

LYCHNIS. See HORTICULTURE, Vol. XII.

LYCON, a Greek philosopher and educator; born about 300 B. C.; a disciple of Strato, and succeeded him as principal of the Peripatetic School, where he taught for 44 years, being especially successful in the mental training of young boys. His eloquence was famous throughout Greece. He wrote a treatise on the boundaries of good and evil, known as *De Finibus*. He died in Athens, about 226 B. C.

LYDDA, the Greek form of the name which appears in the Old Testament as Lod, a town on the road from Jerusalem to Joppa, nine miles E. of the latter. It was the scene of the healing of Æneas by Peter, as told in Acts ix. 32-35, and the watercourse outside the town is said still to bear the name of Abi-Butrus (Peter) in memory of the apostle. It was destroyed by Vespasian and probably not rebuilt until the time of Hadrian, when it was called Diospolis and became the seat of a famous Jewish school of law. The modern town, under the name of Ludd, or El Ludd, is fairly prosperous.

LYDDITE, a high explosive, supposed to be picric acid, but its character and mode of manufacture is a secret of the British Ordnance Bureau. It received its name from Lydd, in Wales, where the explosive, cased in gun-shells, was first experimented with. Shells, filled with lyddite, were used by the British in the war of 1899-1900 with the Boers of South Africa. The explosive power of lyddite is very great, the projectile containing it, when exploded, scattering in destructive pieces, and doing immense destruction wherever the fragments fall. The suffocating effects of its fumes are also deadly. The naval guns used by the British during the siege at Ladysmith had shells filled with lyddite, which wrought great execution among the beleaguering Boers. Lyddite filled shells, it is understood, are now displacing the use of shrapnel shells in the British artillery.

LYDEKKER, RICHARD, an English scientist; born in 1849, in England; graduated at Trinity College, Cambridge, in 1871, being second in the first class of natural science tripos; appointed to the Geological Survey of India in 1874, and continued in this service till 1882, during which he covered nearly the whole of the territory of the Maharajah of Kashmir. He contributed to the

*Palæontologica Indica* his discovery of the large series of vertebrate fossils in the Siwalik Hills, at the foot of the Himalayas. He undertook the huge task of cataloguing the British Museum collections of fossil mamalia, birds, reptiles and amphibia. He published the results of a visit to the Rio de la Plata Museum, in the Argentine Republic (1893), where he had gone to study rare mammal fossils. He was elected a fellow of the Royal Society; became chief editor and part author of Frederick Warne and Company's *Royal Natural History*, the publication of which began in 1895. He published a number of monographs on geological, palæontological and zoological discoveries and mooted questions; and *Horses and Hoofs; Forms and Phases of Animal Life; Life and Rock*.

LYKENS, a borough of Dauphin County, southeastern Pennsylvania, 25 miles E. N. E. of Harrisburg, on the Northern Central and the Williams Valley railroads. It is a coal-mining center and shipping-point, and has foundries and lumber-mills. Pop. 1890, 2,450; 1900, 2,762.

LYMAN, CHESTER SMITH, an American educator and scientist; born at Manchester, Connecticut, Jan. 13, 1844. As early as 1830 and 1831, when a mere lad, he constructed with his own hand optical and astronomical contrivances, and computed, without help or tuition, complete almanacs; graduated from Yale in 1837; taught school from 1838 to 1840; studied theology at the Union Seminary, New York City, and at New Haven, from 1840 to 1842; pastor of a Congregational church in New Britain, Connecticut, in 1845; visited the Sandwich Islands, where he taught the royal children and explored the volcano Kilauea (1845-47); as surveyor in California, he sent out the first authentic news of the discovery of gold in 1849; settled in New Haven, and supplied scientific definitions for the 1864 revision of *Webster's Dictionary*; appointed professor of industrial mechanics and physics at the Sheffield Scientific School (Yale) in 1858-71; professor of astronomy and physics from 1871 to 1884; of astronomy alone from 1884 to 1890. He invented the combined zenith telescope for latitude, longitude and time in 1852, and patented an apparatus for describing acoustic curves in 1871; was president of the Connecticut Academy of Arts and Sciences from 1857 to 1877. His writings are found chiefly in the *American Journal of Science* and *The New Englander*. He died in New Haven, Jan. 20, 1890.

LYMAN, THEODORE, an American philanthropist; born in Boston, Massachusetts, Feb. 20, 1792. He graduated from Harvard in 1810; spent two years of post-graduate studies at the Edinburgh University; afterward traveled through Europe, Turkey, and Asia Minor with his friend Edward Everett; on his return, studied law and was called to the bar; interested himself in state military matters, and reached the rank of brigadier-general; was a member of the Massachusetts legislature from 1820 to 1824; of the state senate (1824-25); mayor of Boston (1834 and 1835), when he rescued William Lloyd Garrison from a mob at the peril of his own life. Much interested in the

Westboro State Reform School, he gave to it \$22,500 during his lifetime and \$50,000 in his will. He wrote several books of travels, and *The Diplomacy of the United States with Foreign Nations* (2 vols., 1828.) He died in Brookline, Massachusetts, July 18, 1849.—His son, THEODORE, an American naturalist, was born in Waltham, Massachusetts, Aug. 23, 1833; graduated at Harvard in 1855, and from the Lawrence Scientific School in 1858; studied in Europe until 1863, when he entered the Union army as aide-de-camp to Gen. G. G. Meade, with the rank of lieutenant-colonel; was present at the battles of the Wilderness, Spottsylvania Courthouse and Cold Harbor; was fish commissioner of Massachusetts from 1865 to 1882; elected a member of Congress on an independent ticket in 1883; an overseer of Harvard University in 1868–80 and 1881–87; a member of the National Academy of Sciences in 1872; gave much time to the study of radiata, and was assistant curator of the Harvard Museum of Zoölogy. He wrote a number of papers on the *Ophiurida* and *Astrophytida* (q.v.), and on the results of deep-sea dredgings during various scientific expeditions. Died at Nahant, Mass., Sept. 10, 1897.

LYMAN, THEODORE BENEDICT, an American divine; born in Brighton, Massachusetts, Nov. 27, 1815. He graduated at Hamilton in 1837, and at the General Theological Seminary, New York City, in 1840; was ordained a priest of the Protestant Episcopal Church in 1841; rector of St. John's Church, Hagerstown, Indiana, from 1841 to 1850; rector of Trinity Church, Pittsburg, Pennsylvania, from 1850 to 1860. Removed to Europe in 1860, and established American churches in Florence and Rome; was rector of Trinity Church, San Francisco, California, from 1870 to 1873; became assistant bishop of North Carolina in 1873, and succeeded Bishop Atkinson in 1881. He died in Raleigh, North Carolina, Dec. 13, 1893.

LYME REGIS, a seaport and favorite watering-place of Dorsetshire, England, at the mouth of the Lyme rivulet, five miles S. of Axminster. The Cobb breakwater, dating from the fourteenth century, was reconstructed in 1825–26. The town, noted for its salt-works before the Norman conquest, was one of the oldest Parliamentary boroughs in England, and was mentioned in the Domesday Book. The Duke of Monmouth set up his standard here in the abortive rising of 1685. The cliffs here are geologically interesting on account of the abundance and character of the fossils they contain. Population, 2,365.

LYMPH. See ANATOMY, Vol. I, pp. 846, 906.

LYMPHATICS. See ANATOMY, Vol. I, p. 906.

LYNCH, PATRICIO, a Chilean sailor; born at Valparaiso, Oct. 18, 1825; graduated from the Chilean Naval Academy. In obedience to orders from his government, he entered the British navy in 1840, and took part in the Anglo-Chinese War, retiring with the rank of lieutenant; served in the Chilean navy from 1847 to 1854; re-entered the service during the war against Spain in 1865, when he commanded a war-vessel; appointed

governor of the Peruvian territory of Tarapacá in 1879, he destroyed \$15,000,000 of property in northern Peru. Promoted to be a rear-admiral and commander-in-chief of the army, he suppressed the Calderon (Peruvian) government and sent the provisional president a prisoner to Chile. In 1883 he defeated Caceres, and placed Iglesias at the head of Chilean affairs. Having been raised to the highest rank in the Chilean navy, that of vice-admiral, he was sent to Spain as minister in 1885. He died near the Canary Islands, on his homeward passage, in May, 1886.

LYNCH, PATRICK WILSON, an American Roman Catholic bishop; born at Cheraw, North Carolina, March 10, 1817. He graduated in theology at the Charleston (South Carolina) Seminary and the College of the Propaganda at Rome. In 1840 he became assistant pastor at the cathedral of Charleston, South Carolina, and from 1844 to 1855 was pastor of St. Mary's Church of that city; became principal of the Charleston Collegiate institute and vicar-general of the diocese in 1850. In 1858 he was consecrated bishop. His articles on the *Vatican Council* (where he supported the dogma of infallibility) and *The Blood of St. Januarius* were published in book-form. He died in Charleston, South Carolina, Feb. 26, 1882.

LYNCH, THOMAS, JR., a signer of the Declaration of Independence; born in Prince George Parish, South Carolina, Aug. 5, 1749. On the organization of the first regiment of South Carolina provincials in 1775 he was commissioned a captain, and in 1776 was elected to a seat in the Continental Congress. On account of failing health he embarked in 1779 for the south of France, but the ship in which he sailed was seen for the last time when a few days out at sea, and probably was lost in a storm.

LYNCHBURG, a city of central Virginia. It is situated on the Chesapeake and Ohio, the Norfolk and Western and the Southern railroads. It is the seat of Randolph-Macon College, a Methodist institution founded in 1893 for the education of women, which had, in 1896, 15 instructors and 125 students, and productive funds of \$205,000. It is the distributing and trade center of a large region. Pop. 1890, 19,709; 1900, 18,891. See also LYNCHBURG, Vol. XV, p. 105.

LYNCHINGS, MOB RULE, AND NEGRO RACE RIOTS. Despite the enormous cost of police protection, not to speak of that of the State militias, the increase of lawlessness in many cities and states of the Union is alarming. Many of our important towns and municipalities are acquiring an evil reputation in consequence of outbreaks being permitted of lynchings and other oft-recurring acts of mob violence. However much passionate outbursts in communities may be excused, when incited by the perpetration of atrocious crimes, the brutalizing effect of lynchings and other unrestrained substitutions for the rule of justice cannot be ignored; while to tolerate them is to break down all respect for law and to dethrone and obliterate every semblance of orderly govern-

ment. Such illegal resorts, in defiance of law and justice, are the more to be deplored when they are directed against any class or condition in the community whose helplessness or misfortune claim consideration from the well-to-do and the strong, and especially in the case of the negro, who is peculiarly apt, at any time, on slight and even on groundless provocation, to be the victim of race and color prejudice, and the arrogant domination of caste feeling. Vicious, in some unfavorable environment, the negro no doubt is; but under like conditions, often vicious also is the white citizen. Both, unfortunately, are to be found among our city toughs and hoodlums; and when caught in disturbances of the public peace the police are not always scrupulously fair, far less merciful, in administering preliminary doses of club-admonition and repression. In the case of the negro, when there has been a disgusting crime committed, the law, we unfortunately find, is not usually left to do its own corrective work. Then is the time when every hot-head thinks he has the right to be the delinquent's Nemesis, and in the name of outraged decency to be himself as indecent and arbitrary as he may—becoming at once constable, judge, jury, and the erring fugitive's instantaneous executioner. Then it is that men act as madmen, throwing restraint and reason to the winds, and commit acts that, in their passionate excesses, would disgrace the age of Nero or the flogging era of the criminal code in the Old World countries.

The growth of this lawlessness and of the murderous work of infuriated mobs that take the law into their own unclean hands is, obviously, of the gravest menace to the State. How the tendency is to be corrected and suppressed should be the anxious thought of every patriotic and law-respecting citizen. Those who have watched recent manifestations of this trend towards anarchy and mob-rule know with what fell precipitance the evil is spreading over the country, and how increasingly it is setting at defiance the majesty as well as the machinery of law. Almost every locality is every now and then hearing, if it is not actually having instances brought more closely to its knowledge, of shootings, lynchings, or other defiant acts on the part of infuriated armed mobs, whose lawlessness is not only extremely demoralizing, but becoming a terror in every well-ordered community, as well as a shame and reproach to the nation. Nor are infractions of the law now confined to the "Wild West," or to sections in the South where race-conflicts and general lawlessness are apt to be looked for; they are also to be found North and East, and among communities that boast a higher type of civilization and a finer degree of culture.

In the past two years the list is an appalling one of the instances of mob violence on record in many parts of the country. There are but few regions exempt from outrages of the worst and most brutal description. Here are a few, selected almost at random during the latter half of the year 1899. At Alma, Kans., on July 9, a negro charged with the murder of two white men was

taken out of the sheriff's hands by a mob and hanged from a telegraph pole. In the same State, at Wier City, on Oct. 30, a colored miner, supposed to be the murderer of a bartender with whom he had quarreled, was taken from jail and hanged.

Kentucky is another State where a like lawlessness has for years been rampant, and where the civil authorities seem to be indifferent to the crying need for its suppression. In Clay County, on Sept. 7, one man was ambushed by a mob and hanged, and on the following day another fellow creature, whatever deserts he merited, met the same fate. On Dec. 6, a young negro of Kentucky, the confessed murderer of the wife of his employer, was at Maysville burned at the stake, after suffering torture at the hands of a mob.

In Louisiana, and especially at New Orleans, the same hideous tale of lynchings and other barbarities is told. In July, 1899, there were five Italians, at Tallulah, wrested from the hand of the law and lynched, the third outrage of the kind reported in the district within a comparatively recent period. On Oct. 15, near Wilson, in the same State, a man suspected of cattle stealing was hanged by a posse of men; while in the adjoining parish dozens of violent deaths had occurred, no one of the murderers having been brought to punishment.

In Mississippi, a like state of things had for some while prevailed, hardly a week passing without some hideous act of burning or hanging being disclosed. Early in the year 1899, a county judge in the State, in charging a jury, spoke of the many instances of crime that disgraced the community that went unpunished by the machinery of the law. So rife were murders and lynchings within the State, that he was moved to remark that "the only thing in Mississippi that was cheaper than four-cent mutton was human life." At Yazoo County, in March of the same year, a triple lynching occurred, two of the victims being taken by an armed and infuriated mob from the hand of the law. At Bolton, in December, two negroes accused of murdering an old white man, were taken from jail and hanged to a bridge by a posse of unmasked rowdies.

During the year 1900 there would seem to be no diminution in the chronicle of race-conflicts here and there in the Union, some of the instances, like those occurring in Alabama, where negroes were burned at the stake, being most revolting in their inhumanity. G. M. A.

LYNE, JOSEPH LYCESTER, called "Father Ignatius," an English clergyman; born in London, Nov. 23, 1837; graduated at Trinity College, Glenalmond, Perth; was ordained in 1860; appointed to the curacy of St. Peter's, Plymouth; left it in 1862 to begin the attempt of restoring monasticism in the Church of England. After occupying provisional quarters in various parts of England, he finally purchased land in the Black Mountains of Wales and built a monastery which he called Llanthony Abbey. He had no difficulty in gathering a number of young men to become the original members of his community. He also

founded a Priory of Nuns. He was the author of many published sermons, poems and hymns; the *Tales of Llanthony*; *Brother Placidus*; *Leonard Morris*; *Tales of the Monastery*; and *Llanthony Monastery Tracts*. He and his monks claim to follow the ancient rule of St. Benedict, and use the Benedictine breviary for choir office and the Sarum missal of the ante-Reformation Church of England. They wear the old English Benedictine dress. "Father Ignatius of Jesus," as he called himself, conducted hundreds of meetings of "revival" character in Great Britain, Ireland and the United States. He headed an ardent campaign, by preaching and petitioning, against the opponents of strict orthodoxy, within the Church of England, and received much approval and assistance from the High Church wing of the Anglican establishment.

LYNN, a city of eastern Massachusetts, on the Boston and Maine and the Boston, Revere Beach and Lynn railroads. The Thomson-Houston electric factory is located here. It employs some fifteen hundred men and turns out machinery for many electric-lighting and power plants. In 1890, 1,343 establishments reported to the Census Bureau, which had an aggregate capital of \$13,000,000, and produced annually \$38,300,000 worth of goods. It is connected with Boston and neighboring towns by electric railroads. Valuation in 1896, \$49,696,356; tax rate, 1.72 per cent; net debt, \$2,887,771. It has a public library containing 51,000 volumes. Population 1890, 55,727; 1900, 68,513. See also LYNN, Vol. XV, p. 109.

LYNN, WILLIAM THYNNE, an English astronomer; born at Chelsea, England, Aug. 9, 1835. Having been trained at the Royal Observatory, Greenwich, he was appointed at the Cambridge Observatory as assistant of Professor Challis in 1855; returned in 1836 to Greenwich as member of the staff under George Airy, the Astronomer Royal; received his B.A. from the London University in 1862. On account of ill health, caused by constant night-exposure, he retired from the Royal Observatory in 1880, and was admitted as a lay reader in the diocese of Rochester. He published, in 1884, a popular volume, *Celestial Motions: A Handy Book of Astronomy*, which ran through a number of editions (8th ed. 1894); contributed constantly to the periodicals in his branch of work, and was elected a member of a number of scientific societies. He wrote *Brief Lessons on Astronomy* and *Remarkable Comets* (1893), another popular success. He was deeply interested in religion, and published *Bible Chronology*; *Brief Lessons on the Parables and Miracles of our Lord* (1889); *Eminent Scripture Characters* (1891); and *Short Catechism of English Church History* (1892).

LYON, DAVID GORDON, an American Orientalist; born at Benton, Alabama, May 24, 1852; studied at Howard College, Alabama, the Southern Baptist Theological Seminary and Leipsic University; appointed Hollis professor of divinity at Harvard in 1882. He gave his attention for many years to the language, history and antiqui-

ties of Assyria, and wrote *An Assyrian Manual for the use of Beginners in the Study of the Assyrian Language* (1886; 2d ed. 1892).

LYON, MARY, an American educator; born in Buckland, Massachusetts, Feb. 28, 1797. From 1814 to 1837 the most of her time was devoted to teaching in various schools, and in the latter year she founded Mount Holyoke Seminary, at South Hadley, Massachusetts. From that date to her death she served as its principal. A peculiarity of her system was, that the institution contained no servants, the whole of the domestic labor being performed according to a regular method by the teachers and pupils themselves. A number of her pupils became missionaries. She published *Tendencies of the Principles Embraced and the System Adopted in the Mount Holyoke Seminary* (1840) and *Missionary Offering* (1843). She died in South Hadley, Massachusetts, March 5, 1849.

LYON, MATTHEW, an American public man; born in County Wicklow, Ireland, in 1746. He emigrated to the United States when a boy; after working on a Connecticut farm, he settled in Vermont, where, in 1776, he became lieutenant of the "Green Mountain Boys"; later he was elected, successively, member of the legislature and assistant judge; was one of the founders of Fairhaven in 1783, where he built several factories and founded a newspaper called *The Scourge of Aristocracy and Repository of Important Political Truth*; elected to Congress in 1797; convicted the next year of libel against President Adams, he was sentenced to four months' imprisonment and a \$1,000 fine; in spite of that, he was re-elected to Congress; took part in several brawls on the floor of the House; settled in Kentucky in 1803; elected to the Kentucky legislature, and to Congress in 1803-11; in 1820 he was appointed United States factor among the Cherokees in Arkansas; elected delegate to Congress from Arkansas Territory, but soon after his election died at Spadra Bluff, Arkansas, Aug. 11, 1822.

LYON, NATHANIEL, an American soldier; born in Ashford, Connecticut, July 14, 1818. He graduated at West Point in 1841, and served as a lieutenant of infantry in Florida toward the close of the Seminole war. In the war with Mexico he was present at the siege of Vera Cruz and brevetted captain; at the assault on the Mexican capital he was wounded. At the close of hostilities he was ordered to California, where, in 1851, he was promoted captain. Returning to the East in 1853, he sympathized with the Free State Party. He was on duty in Kansas in 1850, and with General William S. Harney, in December, 1860, when the governor sent a brigade of militia to co-operate with the federal troops in arresting James

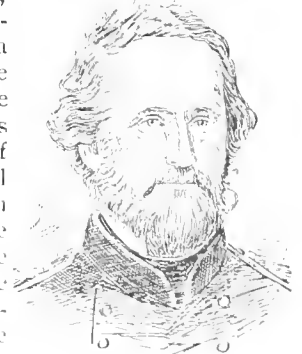

GENERAL LYON.

Montgomery, the Free State leader. In February he was ordered to St. Louis, Missouri. There he began to drill and organize the Home Guards, and had charge of the arsenal, where his ability and vigilance did much for the Union cause. On June 10, 1861, at the head of a body of German troops, he took possession of Camp Jackson, a secessionist rendezvous. A week later he was promoted to brigadier-general of volunteers, and soon afterward was placed in command of the department. He next dispersed the Confederate force at Potosi, and on June 17th defeated a body of Governor Jackson's state militia. On Aug. 2d he defeated General McCulloch at Dry Springs, and on Aug. 7th attacked a formidable force, under Generals McCulloch and Price, at Wilson's Creek, when he was defeated. Here, in the ardor of action, he was twice wounded; nevertheless, keeping his saddle, he led his men to renewed attacks, until his horse was killed and himself shot in the breast by a Minié rifle-ball, Aug. 7, 1861. His death was deeply lamented throughout the Union. He bequeathed his whole private fortune to the United States government to aid in the success of the Union cause. After his death some of his letters to political friends, at the time of the Kansas troubles, were published under the title of *The Last Political Writings of General Nathaniel Lyon*.

LYONS, a city of Clinton County, central eastern Iowa, situated on the Mississippi River, four miles above Clinton, on the Chicago, Milwaukee and St. Paul and the Chicago and North-Western railroads. It has extensive nurseries, several excellent schools and manufactories of wrapping-paper, flour, oil-cans, lumber, machinery and carriages. Population 1890, 5,799; has since been annexed by Clinton city.

LYONS, a city and the capital of Rice County, central Kansas, situated 26 miles N.E. of Hutchinson, on the Atchison, Topeka and Santa Fé, the Missouri Pacific and the St. Louis and San Francisco railroads. It is in a productive salt region, with beds said to be 268 feet thick. It has wagon and carriage works, elevators and flour-mills. Population 1890, 1,754; 1900, 1,736.

LYONS, a post village and the capital of Wayne County, northwestern central New York, 35 miles E. of Rochester, on the New York Central and Hudson River and the Western New York and Pennsylvania railroads, and on the Erie canal. It is a peppermint-oil market, manufactures fanning-mill machinery, silverware, tool-handles, iron goods and farm implements, and has splendid water-power. A musical academy is located here. Population 1900, 4,300.

LYRE-TURTLE, the common name of a very large tropical sea-turtle, which has the scientific name *Dermochelys coriacea*. The general outline is lyre-shaped, and the dorsal keels bear some fancied resemblance to the strings on a lyre. Unlike all other turtles, the carapace is not connected with the skeleton. The flesh is oily, and not edible. Specimens of this turtle weighing a thousand pounds are sometimes taken.

LYRIC POETRY. See POETRY, Vol. XIX, p. 264.

LYS, a river of France and Belgium, rising in the department of Pas-de-Calais and flowing generally northeast, joining the Schelde at Ghent. Length, 100 miles, of which 44 are canalized. It is connected with numerous other canals and has an active navigation.

LYSIAS OF SYRIA. See ISRAEL, Vol. XIII, p. 422.

LYSONS, DANIEL, an English antiquary; born at Rodmarton, England, April 28, 1762; received his A.M. from Oxford in 1785; entered the Church of England as curate of Putney in 1790, and became rector of Rodmarton in 1804. He gathered an enormous amount of material for antiquarian histories of the various counties in Great Britain. One of his works he completed and published in five volumes, under the title of *The Environs of London*, being an historical account of the towns, villages and hamlets within twelve miles of that capital (1792-1800). His more ambitious work, *Magna Britannia*, being a concise topographical account of the several counties of Great Britain (6 vols., 4to, 1806-22), only reached, in alphabetical order, the county of Derby; the documents collected are preserved in the British Museum, forming 64 huge manuscript volumes. He died at Rodmarton, Jan. 3, 1834.—His son, GENERAL SIR DANIEL LYSONS, was born at Rodmarton, Aug. 1, 1816, entered the army from Shrewsbury School in 1834, and served through the Canadian rebellion of 1838-39; became captain in a West India regiment in 1841; served throughout the Crimean War, and often was mentioned in dispatches; was wounded severely at the final assault on the Redan; commanded a brigade to the end of the war. In 1861, after the *Trent* affair, he was sent to Canada to reorganize the militia. After serving at Malta and at Aldershot, he was appointed quartermaster-general in 1876; grand cross of the Bath (1886); general (1879); constable of the Tower (1890). Died in London, January 29, 1898.—A brother of the first Daniel, SAMUEL LYSONS, was also a distinguished antiquary. He was born at Rodmarton, May 17, 1763. Besides assisting his brother in his work, he published works on British antiquities. He was called to the bar in 1798; was keeper of the records in the London Tower in 1803, and wrote *Reliquiæ Britannico-Romanae*, with figures of Roman antiquities discovered in various parts of England (folio, with 156 colored plates, 1813-17); *The History and Antiquities of Devonshire* (2 vols., 4to, 1822). He died in London, June 29, 1819.

LYSTRA, an ancient city of Asia Minor, probably in Lycaonia. It was the native place of Timothy, and was visited by St. Paul in his missionary journeys; here he and Barnabas were taken for Jupiter and Mercury by the inhabitants, on account of the healing of the lame man, and they attempted to sacrifice to them. Later, Paul was driven out of the city with stones (Acts xiv). It has been located at the modern Zoldera.

LYTTELTON, THOMAS, LORD, son of George,

the first Baron Lyttelton, an English writer; born in 1744; as a boy of 16 he was considered a prodigy of intellectual development and a deep scholar; his later life was so dissolute that he lost most of his advantages, being even estranged from his father on account of an unwise marriage that terminated in a separation. Being elected to the House of Commons in 1768, he lost his seat on contest; entered the House of Lords at his father's death in 1773; was suspected strongly of being the author of the *Letters of Junius* in the *Public Advertiser*. He died in 1779.

LYTTELTON, MAJOR-GENERAL, THE HON. NEVILLE GERALD, C. B., recently in command of the 2nd Infantry brigade at Aldershot, and since the outbreak of the Boer war of 1899-1900 in command of the Fourth (British) Brigade in South Africa, was born in 1845 and educated at Eton. In 1865 he entered the Rifle Brigade and served with it in Canada and in India, seeing a good deal of active service. From 1868 to 1873 he acted as A. D. C. to Lord Spencer, viceroy of India, and was military secretary to the late Sir John Adye, governor of Gibraltar, and to Lord Reay, governor of Bombay. He was in the Egyptian campaign in 1882 and commanded a brigade in the Nile Expedition of 1898, being present at the battle of Khartum. During 1897-98 he was assistant military secretary at the war office in England, and in 1899 got the command of a brigade in South Africa.

LYTTON, EDWARD ROBERT BULWER-LYTTON, EARL OF, a British poet and diplomatist, and only son of the novelist, Bulwer-Lytton, was born in London, Nov. 18, 1831. He was educated at Harrow and afterward at Bonn, where he specially studied modern languages to fit himself for the English diplomatic service. In 1849 he became an *attaché* of the British legation at Washington, where his uncle, Sir Henry Bulwer, afterward Lord Dal-

ling and Bulwer, was minister. From Washington he was transferred to Florence, and thereafter he served at the embassy at Paris, at The Hague, at Constantinople and at Vienna. In 1863 he became secretary of legation at Copenhagen, where, later on, he acted as *chargé d'affaires*, subsequently discharging similar duties at Lisbon, Madrid and Paris. In 1873 he succeeded to his father's barony. In the following year he became ambassador at Lisbon and in 1876 Viceroy of India. On Jan. 1, 1877, his Indian viceroyalty was marked by the great ceremonial on the plains of Delhi, at which Queen Victoria was proclaimed Empress of India, and during his administration in the East a war with Afghanistan occurred. In 1880, on the fall of the Beaconsfield government, Lord Lytton resigned, when he was created earl. Seven years later he was appointed ambassador at Paris, where he died, Nov. 24, 1891.

Under the name of "Owen Meredith," Lord Lytton published a number of volumes of verse. He had no little mastery of the art of poetry, "especially that of turning a modern novel (as in *Lucile* [1860]) into a poetical narrative." This rhymed romance was preceded, in 1855 by *Clytemnestra, and Other Poems*, and followed by *Tannhauser, or, The Battle of the Bards* (1861); and *The Ring of Amasis* (1863). *Glenaveril* (1885) is a poem or rhymed narrative of much the same character as *Lucile*, though of higher and more serious purpose. In 1874 appeared *Fables in Song*, perhaps his best work; in 1887, *After Paradise; or, Legends of Exile*; and in 1892, *Marah and King Poppy*. His father's *Speeches* (with some of his political writings) he edited in 1874; and in 1883 he issued *The Life, Letters and Literary Remains of Edward Bulwer, Lord Lytton*. In 1890 a selection from "Owen Meredith's" poems appeared, edited by M. Betham-Edwards, enshrining much of Earl Lytton's choicest verse.

## M

## MAA—McALPINE

**MAA** OR **MA**, a goddess. See **COMANA**, Vol. VI, p. 177.

**MAAMTRASNA MURDERS**. See **HOME RULE**, in these Supplements.

**MAARTEN, MAARTENS**. See **VAN DER POORTEN-SCHWARTZ**, in these Supplements.

**MAASE**. See **MEUSE**, Vol. XVI, p. 205.

**MABERY, CHARLES FREDERIC**, an American scientist; born in Maine, Jan. 13, 1850, graduated from the Lawrence Scientific School at Harvard in 1876; was assistant in chemistry there (1875-83); was called to the chair of chemistry in the Case School of Applied Science, at Cleveland, Ohio (1883), and made many interesting experiments with regard to the production of aluminium by electricity.

**MABIE, HAMILTON WRIGHT**, an American editor and author; born at Cold Springs, New York, in 1846; graduated at Williams College in 1867, and at the Columbia Law School, New York City, in 1869. He preferred a literary career, and in 1879 became associated with Dr. Lyman Abbott on *The Christian Union* (changed to *The Outlook* in 1893). He edited Michaud's *History of the Crusades*, adding a supplementary chapter. He wrote *Norse Stories from the Eddas* (1882); *My Study Fire* (1890); *Our New England* (1890); *Under the Trees* (1891); *Short Studies in Literature* (1892); *My Study Fire: Second Series* (1894); *Books and Culture* (1897); *Work and Culture* (1898); *The Forest of Arden* (1898). In these studies and criticisms he exhibited a cultivated taste, a mature judgment, and a graceful diction.

**MABINOION**. See **CELTIC LITERATURE**, Vol. V, pp. 321-22.

**MACABRE**. See **DANCE OF DEATH**, *ante*, p. 984.

**MACADAM, JOHN LOUDON**, a British road-builder; born in Ayr, Scotland, Sept. 21, 1756; died Nov. 26, 1836. See also **ROADS**, Vol. XX, pp. 582, 583.

**MACAHUBA PALM**, the native name of *Acrocomia sclerocarpa*, the *macoya* or *great macawtree* of South America and the West Indies. The tall and prickly trunk bears at its summit a tuft of very large pinnate leaves. The fruit consists of a soft, sweetish pulp and an edible seed, from which is extracted a fragrant oil used in soap-making and as an ointment.

**MACALESTER COLLEGE**, a Presbyterian institution of learning, founded in 1885, at St. Paul, Minnesota. In 1895 it consisted of 8 instructors, 94 students and a library of 5,000 volumes. Since its organization 22 students have graduated there. It is a young but promising institution.

**MACALISTER, JAMES**, a Scotch-American educator; born in Glasgow, Scotland, April 26, 1840; studied at Glasgow University, and later at Brown University, Providence, Rhode Island;

received his degree in law at Albany in 1864; became superintendent of public schools, Milwaukee, Wisconsin, in 1873; regent of Wisconsin normal schools from 1878 to 1883; superintendent of public schools, Philadelphia, Pennsylvania, in 1887. He advocated the development and multiplication of the kindergarten, and of industrial and manual training. He wrote *Manual of Primary Instruction* (1884); *Manual of Instruction in United States History and Civil Government* (1887).

**MCALLISTER, WARD**, an American "society leader"; born in Savannah, Georgia, in 1830. He was admitted to the San Francisco bar in 1851, and practiced some time with his elder brother, **HALL**, a prominent lawyer; but having married, in 1855, Miss Gibbons, a Georgia belle, he retired from his profession and settled in New York. He soon was recognized as a leader and an arbiter in all matters concerning social functions, and, managed to retain his influence over what is called the New York four hundred until his death. He was a man of culture, very simple in dress and mode of living, and not in any way a Beau Brummel or a dandy of the new régime. He died in New York City, Jan. 31, 1895.

**MCALL MISSION**, the largest Protestant mission in France. It was started in 1871 by the Rev. Robert Whitaker McAll and his wife, and is there known as "Mission Populaire Evangélique de France." Mr. McAll was born in Macclesfield, England, Dec. 17, 1821. He was a Congregational pastor in Manchester and Birmingham for twenty years; shortly after the Paris Commune of 1871 he began his evangelizing work in the quarters of Paris inhabited by the laboring classes; his wife assisted him greatly, especially in the compiling of an excellent hymn-book; the value of his work as a civilizing agent was recognized by a gold medal from the Society for the Encouragement to Well-Doing and by the cross of the Legion of Honor. The mission possessed, in 1895, over 120 stations (forty in Paris alone), and is indorsed by the clergymen of all Protestant churches. Five sixths of the workers are French; the others English, American, etc. The United States contributes yearly \$50,000 to this work. He died May 11, 1893.

**MCALPINE, WILLIAM JARVIS**, an American civil engineer; born in New York City in 1812; educated in New York City as a civil engineer, he made a specialty of constructing canals and other hydraulic works; he had charge of the Erie canal improvements, and in 1846, of the building of a dry-dock in the United States navy-yard at Brooklyn; was state engineer of New York in 1851; state railroad commissioner in 1855-57; engineer of several railroad lines; constructor of the Albany, New York City and the Chicago



water-works, and planned those in Brooklyn, New Bedford, and elsewhere; presented plans for the improvement of navigation on the lower Danube approved by the International Commission; was superintendent of the new state capitol at Albany, New York, in 1873-74; engineer of the department of parks, New York City, in 1879-80; planned the One Hundred and Eighty-first Street Bridge and the Riverside Drive in New York; was president of the American Society of Civil Engineers in 1869. He died at New Brighton, Staten Island, Feb. 16, 1890.

MACAQUE. See APE, Vol. II, p. 152.

MACARONIC VERSE. See FOLENGO, Vol. IX, p. 355.

MCARTHUR, DUNCAN, an American pioneer and soldier; born in Dutchess County, New York, June 14, 1772. At the age of 18 he was a volunteer in General Josiah Harmar's expedition against the Miami Indians; took part in Indian warfare in Kentucky and Ohio; settled in Chillicothe in 1795 as a surveyor, and acquired wealth. He was elected member of the Ohio legislature in 1805; became major-general in command of the Ohio militia in 1808; commanded the First Ohio Volunteers during the War of 1812; was included in the surrender of General William Hull, at Detroit, but was freed from all responsibility and appointed brigadier-general in 1813; placed in command of the Western army in 1814, when General Harrison resigned; was elected member of Congress from Ohio in 1813, but declined to leave the army; was mustered out June 15, 1815; was commissioner to treat with the Indians in 1816-17; by this treaty, ratified in 1818, vast territories were transferred from the Indians to the government; was speaker of the house of representatives of Ohio in 1817-19; elected to Congress, as a Clay Democrat (1823-25); governor of Ohio (1830-32). He died near Chillicothe, Ohio, April 28, 1839.

MCARTHUR, ROBERT STUART, an American clergyman and author; born at Dalesville, Quebec, July 31, 1841; graduated at Rochester University and Rochester Theological Seminary; pastor of Calvary Baptist Church, New York City, in 1870; associate editor of *The Baptist Enquirer* and *The Baptist Quarterly Review*. He published, with Rev. Charles S. Robinson, *Calvary Selection of Spiritual Songs* (1878); and *Laudes Domini* (1891); also, with Miss Kate S. Chittenden, *The Calvary Hymnal* (1891).

MACASSAR. See CELEBES, Vol. V, p. 288.

MACAULAY, JAMES, a Scotch author; born in Edinburgh, May 22, 1817. In 1841 he graduated in arts and medicine from Edinburgh University, having also attended the classes in theology. He further studied in Paris, and traveled in Italy and Spain. In 1851 he became joint editor of the *Literary Gazette*, and in 1858 editor of the *Leisure Hour* and the *Sunday at Home*. From the same office was issued, in 1880, *The Boy's Own Paper*, destined to raise the average of young lads' habitual literature; it was soon followed by *The Girl's Own Paper*. Among his many books—juvenile and others—are *All True*; *Stirring Stories of Peace and*

*War*; *Wonderful Tales from Real Life*; *From Middy to Admiral of the Fleet*; *Across the Ferry*; *Notes of a Tour in the United States*; *The Truth About Ireland*; *Sea Pictures*; *Victoria R. I., Her Life and Reign* (1887); he was for thirty-five years editor-in-chief of the Religious Tract Society's periodicals.

MCCABE, CHARLES CARDWELL, an American Methodist clergyman; born in Athens, Ohio, Oct. 11, 1836; graduated at Ohio Wesleyan University in 1857; entered the ministry in the Ohio Conference in 1860. From 1860 to 1863 he was chaplain of the One Hundred and Twenty-second Ohio Regiment; captured by General Early, he spent four months in Libby Prison; on being exchanged, he lectured on behalf of the Christian Commission, raising over \$100,000 for that excellent



REV. C. C. MCCABE.

work among the sick and suffering. He returned to his regiment, and followed it to the end of the war, with short interruptions brought about by ill-health and overwork. In 1868 he was chosen as financial agent for the extension of the church, and during his 17 years of tenure of this office he traveled no less than 25,000 miles annually in the discharge of his duties. As corresponding secretary of the Methodist Episcopal Missionary Society, he raised the revenue of the society from \$750,000 to \$1,250,000 per annum. Known as a preacher of convincing power. In the army his musical talent gave him the title of "the Singing Chaplain."

MCCALL, GEORGE ARCHIBALD, an American soldier; born in Philadelphia, Pennsylvania, March 16, 1802. He graduated at the United States Military Academy in 1822; from 1831 to 1836 served as aide to Gen. E. P. Gaines, and then in the Florida and Mexican wars, receiving the brevets of major and lieutenant-colonel. From 1850 to 1853 he was inspector-general of the army. In 1861 he was made brigadier-general, and at the battle of Mechanicsville, June 26, 1862, being in command of all the federal troops, repelled greatly superior forces. Taken prisoner on the 30th, he was confined for several weeks in Libby Prison. His ill-health obliged him to resign from active service in 1863. He wrote *Letters from the Frontier* (1868). He died in West Chester, Pennsylvania, Feb. 26, 1868.

MACCALUBA, a remarkable mud volcano, 138 feet in height, situated six miles N. of Girgenti, in Sicily. The sides are studded with numerous small cones, which usually emit hydrogen and occasionally mud and stones, often sending them to a great height.

MACCARTHY, DENIS FLORENCE, an Irish poet and translator; born in Dublin in 1817. He first became known through his contributions to the *Nation*. His collected *Ballads, Poems and Lyrics*, founded upon the patriotic traditions of the Irish, appeared in 1850, and became quickly popular, especially his *Voyage of St. Brendan* and *The Foray*

of *Con O'Donnell*. In 1853 he published six of Calderon's dramas translated in the meters of the original. In 1872 appeared *Shelley's Early Life*, and in 1879 he wrote the ode for the Moore centenary. In recognition of his literary merit he received a pension in 1871, and in 1881 a medal from the Royal Academy of Spain. He died April 7, 1882.

MCCARTHY, JUSTIN, an Irish journalist, author and statesman; born in Cork, Nov. 22, 1830. He joined



JUSTIN M' CARTHY.

the staff of the *Northern Times*, Liverpool, in 1853, and in 1860 entered the reporters' gallery of the House of Commons for the *Morning Star*, becoming its foreign editor the following autumn, and chief editor three years later. He resigned in 1868, and devoted the next three years to a complete tour of the United States. Soon after his return he joined the staff of the London *Daily News*, contributing besides, among other magazines, to the *London*, the *Westminster* and the *Fortnightly Review*. He entered the House of Commons in 1879 as member for Longford, and identified himself throughout with the Home Rule party. In 1890 he was chosen leader of the Irish Parliamentary party in place of Mr. Parnell. McCarthy's novels, perhaps, have achieved for him a wider fame than his political triumphs. The more successful among them are *The Waterdale Neighbors* (1867); *My Enemy's Daughter* (1869); *Lady Judith* (1871); *A Fair Saxon* (1873); *Lindley Rochford* (1875); *Dear Lady Disdain* (1875); *Miss Misanthrope* (1877); *Donna Quixote* (1879); *The Comet of a Season* (1881); *A Maid of Athens* (1883); *The Dictator* (1893); *Red Diamonds* (1893); and, in collaboration with Mrs. Campbell-Praed, *The Right Honorable* (1886); *The Rebel Rose* (1887); and *The Ladies' Gallery* (1888). He also wrote *Con Amore*, a collection of essays; *Critical Notice of George Sand* (1870); *Prohibitory Legislation in the United States* (1872); *Modern Leaders* (1872); *A History of Our Own Times* (4 vols., 1879-80); *History of the Four Georges* (4 vols., 1889 et seq.);



GENERAL GEO. B. M'CLELLAN.

*A Life of Sir Robert Peel* (1891); and *The Story of Gladstone's Life* (1898).  
MCCLELLAN, GEORGE BRINTON, an American general; born in Philadelphia, Pennsylvania, Dec. 3, 1826. He was educated by private tutors; studied for two years at the University of Pennsylvania, and in 1842 entered the United States Military Academy at West Point, graduating four years later. He was assigned to an engineer corps and served throughout the Mexican War, gaining the brevets of lieutenant and captain. In 1848 he was appointed assistant instructor in

practical engineering at West Point, and from 1852 to 1855 was employed on various engineering expeditions. In the latter year he was raised to the rank of captain of cavalry, and sent with Colonel Richard Delafield and Major Alfred Mordecai to the Crimea to observe the operations of the allied armies. McClellan's report, published by Congress with others, was republished in 1861 under the title, *The Armies of Europe*. In 1857 McClellan resigned from the army and became chief engineer and vice-president of the Illinois Central railroad.

When the Civil War broke out he was appointed major-general of Ohio volunteers and given command of the Department of the Ohio, which included the states of Ohio, Indiana, Illinois and part of Virginia and Pennsylvania. He immediately, and without orders, advanced into the western part of Virginia, which had been overrun by the Confederates under General Garnett, whom, after an eight-days' campaign, begun May 26, 1861, he forced to retreat with some loss. As a result of the move, the people in that part of the state called a convention, declared their loyalty, and were allowed to enter the Union as a separate state Dec. 31, 1862.

On May 14, 1861, McClellan had been made major-general in the United States army, and in July of the same year he was called to Washington, and in August given command of the Army of the Potomac, and upon the retirement of General Scott, in November, command of all the armies of the United States. He found the forces around Washington completely demoralized and dispirited by the result of the first battle of Bull Run, and set to work systematically to create and discipline an army before attempting any move against the enemy. The work of organization was done well but slowly, and this tardiness alienated from him the administration authorities, who were eager for immediate action. Moreover, there was a difference of opinion between him and the President as to how the campaign should be arranged. At last a compromise was reached, and on March 10, 1862, the army was set in motion, and the disastrous Peninsula campaign began. There seem to be four reasons to account for McClellan's failures: his too great cautiousness; his over-estimation of the enemy's strength in numbers; the lack of unanimity between himself and the administration; and lastly, his hesitation in altering his pre-arranged plans to meet the unexpected exigencies of a campaign. The first move was made on Manassas, but as the Confederates had been informed that the ultimate plan of the campaign was to transport the troops to the lower Chesapeake, and from thence march by land to Richmond, they had abandoned their position and retreated southward before the Union forces arrived. After this useless move, the real campaign was begun, by transporting the troops, by water, to Fortress Monroe. McClellan had scarcely left Washington when he was informed that he had been deprived of his command of all the armies. Besides this, he learned that twelve regiments of McDowell's corps, which he had counted upon as a reinforcement, had been detached from the main body for the defense of Washington. As it hap-

pened, none of McDowell's corps was allowed to take part in the campaign. McClellan protested, and on April 5th commenced the siege of Yorktown. Here he greatly over-estimated the strength of the enemy and regularly besieged the place for a month, much to the surprise of General Magruder, who held the works with a garrison of five thousand men and evacuated the town as soon as it was evident that a vigorous assault was to be made. The army was then moved up the peninsula to the Chickahominy River, Williamsburg being taken May 6th, after a struggle, the Confederates falling back as the Union troops advanced. On May 31st General Joseph E. Johnston attacked the Union left, on the Chickahominy, and the battle of Fair Oaks (q.v.), or Seven Pines, was fought. No farther advance, however, was made upon Richmond, but instead, McClellan determined upon a retreat to the James River, where, with that stream for a base of operations, a new attack upon Richmond could be arranged. Thereupon followed the Seven Days' battles, from June 25th to July 1st, which terminated when the Union forces reached Harrison's Landing, on the James. McClellan was now ready to make another move against Richmond, but the administration had lost confidence in him. On July 11th Halleck was made commander-in-chief of the Union forces, and on August 3d McClellan was ordered to evacuate the peninsula, and afterward deprived of his command, his forces being added to General Pope's army in northeastern Virginia. After the disastrous second battle of Bull Run he was given command of this army, Pope having resigned command of the Army of the Potomac. On September 17th he met the Confederate forces under Lee and Jackson, and the battle of Antietam (q.v.) was fought, the Confederates being forced to retreat from their position. McClellan was then urged to follow the enemy, but he hesitated to do so until his army should have recovered fully from the shock of the battle, and on that account he was relieved of his command, Nov. 7, 1862, and Burnside put in his place.

After this, McClellan took no further part in the war. In 1864 he was the Democratic nominee for President against Lincoln, and was defeated overwhelmingly. Immediately after the election he went to Europe, where he remained until 1868. Returning, he engaged in engineering pursuits, and in 1870-72 was engineer-in-chief of the department of docks of New York City. In 1877 he was elected governor of New Jersey. He was the author of *A Manual of Bayonet Exercise* (1852); *Report on the Organization and Campaigns of the Army of the Potomac* (1864); and *McClellan's Own Story* (1866). He contributed the article on NEW JERSEY, in this ENCYCLOPÆDIA. He died at Orange Mountain, New Jersey, Oct. 29, 1885.

McCLERNAND, JOHN ALEXANDER, an American lawyer and general; born in Breckenridge County, Kentucky, May 30, 1812. In 1832 he began the practice of law in Shawneetown, Illinois, and in 1835 established the Shawneetown *Democrat*. From 1836 to 1842 he was a member of the state legislature, and from 1843 to 1851 served in Congress. In

1859 he was again chosen to Congress, and served till the beginning of the Civil War, when he resigned and was appointed brigadier-general of volunteers in the Union army. He was made major-general in 1862, and took part in the attack on Fort Donelson, the battle of Shiloh and the capture of Vicksburg. He was relieved of his command of the Thirteenth Army Corps in July, 1863, and resigned from the army November, 1864.

McCLINTOCK, SIR FRANCIS LEOPOLD, a British explorer; born in Dundalk, Ireland, in 1819. At the age of 12 he entered the navy, and in 1845 was promoted to a lieutenancy. He was a member of an Arctic expedition sent in search of Sir John Franklin in 1848, and of another sent out in 1849. In 1851 he was promoted to the rank of commander, and put in charge of the *Intrepid*, one of the five vessels sent to the polar regions under Sir Edward Belcher. In 1857 Lady Franklin gave him the command of the expedition sent out by her, which resulted in solving the mystery of Sir John Franklin's fate. In 1860 he was knighted; in 1871 was made rear-admiral; in 1877, vice-admiral; and in 1884, full admiral. He was the author of *The Voyage of the "Fox" in the Arctic Seas* (1860).

McCLINTOCK, JOHN, an American educator; born in Philadelphia, Pennsylvania, Oct. 27, 1814. He graduated at the University of Pennsylvania in 1835, and was ordained in the Methodist Episcopal Church. He held the chairs of mathematics (1836-39) and Greek and Latin (1839-51) in Dickinson College; from 1848 to 1856 edited the *Methodist Quarterly Review*; was pastor of St. Paul's Methodist Episcopal Church, New York (1857-60); in 1860-64 was pastor of the American chapel in Paris; and in 1867 became the first president of Drew Theological Seminary at Madison, New Jersey. His great work was his *Cyclopadia of Biblical, Theological, and Ecclesiastical Literature* (10 vols., 1867-82). He wrote also *Sketches of Eminent Methodist Ministers* (1863), and translated Bungener's *History of the Council of Trent* (1855). His *Life and Letters* by Rev. George R. Crooks was published in 1876. He died in Madison, New Jersey, March 4, 1870.

McCLOSKEY, JOHN, an American Roman Catholic cardinal; born in Brooklyn, New York, March 20, 1810. He was educated at St. Mary's College, Emmittsburg, Maryland, and in 1834 was ordained priest. He studied in Rome for two years, and in 1837 was appointed pastor of St. Joseph's Church, New York City. In 1841 he became the first president of Fordham College, New York, but held the post only a year. In 1844 he was consecrated bishop, and made coadjutor of the diocese of New York. In 1847 he was appointed bishop of the new see of Albany, and while there he founded the theological seminary at Troy. In 1864 he was made



CARDINAL McCLOSKEY.

Archbishop of New York to succeed Archbishop Hughes, and in 1875 was created cardinal, being the first of that rank in the American church. He died in New York City, Oct. 10, 1885.

McCLURE, ALEXANDER KELLY, an American journalist; born in Perry County, Pennsylvania, Jan. 9, 1828; edited the Mifflin (Pennsylvania) *Sentinel* (1846-50), and the Chambersburg *Repository* (1850-56); served in the Pennsylvania state legislature as a Republican. He supported Lincoln in 1860 and 1864, and Greeley in 1872; was an unsuccessful candidate for mayor of Philadelphia, and established the *Times* of that city in 1874, from which year he has been its editor.

MACCOLL, MALCOLM, a British ecclesiastic and author; born in Glenfinan, Inverness-shire, March 27, 1838. He was educated in Edinburgh, and in 1861 was appointed assistant-curate of St. Paul's, Knightsbridge; in 1862 was chaplain to the British Ambassador at St. Petersburg; curate of St. Paul's, 1864-67; traveled in Italy, 1867-69; in 1871, made rector of St. George, Botolph Lane, London; in 1884, canon of Ripon. He is the author of *Mr. Gladstone and Oxford* (2d ed., 1865); *Science and Prayer* (4th ed., 1866); *The Ober-Ammergau Passion Play* (6th ed., 1870); *The Eastern Question* (1877); and *Christianity in Relation to Science and Morals* (3d ed., 1890).

MCCOMB, a village of Hancock County, northeastern Ohio, eight miles W.S.W. of Findlay, on the Cincinnati, Hamilton and Dayton and the New York, Chicago and St. Louis railroads. It is in a natural-gas belt, and has saw and grist mills, sash-and-blind factories, grain-elevators, furniture factories and tile-works. It is also in a rich farming region and oil-field. Population 1900, 1,195.

MCCOMB CITY, a town of Pike County, central southern Mississippi, 75 miles S. of Jackson, on the Illinois Central railroad. It is in a cotton and corn growing region, and is a supply-center for a large district. Population 1890, 2,383; 1900, 4,477.

MCCONNELSVILLE, a village and the capital of Morgan County, southeastern Ohio, 25 miles S.E. of Zanesville, on the Muskingum River and on the Zanesville and Ohio railroad. It is in an agricultural and natural-gas region, and manufactures flour, tobacco, agricultural implements, wagons, etc. There are extensive salt-works in the vicinity. Population 1890, 1,771; 1900, 1,825.

McCOOK, a city of Red Willow County, central southern Nebraska, 90 miles W.S.W. of Kearney, on the Republican River and on the Burlington and Missouri Valley railroad. It is in a farming and stock-raising region, and has the division headquarters and repair-shops of the railroad. It has a large lumber-yard, a creamery, flour-mills and a brick-yard. Population 1890, 2,346; 1900, 2,445.

McCOOK, the name of an American family of Scotch-Irish descent, remarkable for the number of its members who won distinction in the Union army during the Civil War, wherein they were known as the "Fighting McCooks." Of the ancestral stock:—DANIEL, born in Cannonsburg, Pennsylvania, June 20, 1798 was the son of an Irish refugee. Having been educated at Jef-

erson College, he removed to New Lisbon, and afterward to Carrollton, Ohio, and at the outbreak of the Civil War, although 63 years of age, enlisted in the Union army, and was commissioned major. He was killed near Buffington's Island, Ohio, July 21, 1863, while leading a party to oppose General Morgan's raid.—His son, GEORGE WYTHE, born at Cannonsburg, Pennsylvania, Nov. 21, 1821, fought in the Mexican War, and at the outbreak of the Civil War was made brigadier of Ohio volunteers, but owing to ill-health was able to assume command only for short periods. Died Dec. 28, 1877.—ROBERT LATIMER, another son, was born in New Lisbon, Ohio, Dec. 28, 1827; at the beginning of the Civil War he organized the Ninth Ohio Regiment; was promoted brigadier-general of volunteers, and was shot and killed while lying wounded in an ambulance near Salem, Alabama, Aug. 6, 1862.

—ALEXANDER McDOWELL, another son; born in Columbiana County, Ohio, April 22, 1831; graduated at the United States Military Academy in 1852; entered the infantry, and served in New Mexico against the Apaches; was instructor at West Point (1858-61); and was promoted to the rank of first lieutenant in 1858. At the outbreak of the Civil War he was appointed colonel of the First Ohio Regiment, which he commanded in



GEN. ALEX. M. McCOOK.

the battle of Bull Run, gaining the brevet of brigadier-general of volunteers; commanded a division of the Army of the Ohio in the Tennessee and Mississippi campaigns, and received the brevet of colonel in the regular army after Shiloh; commanded the Twentieth army corps in the battles of Perryville, Murfreesboro and Chickamauga; in 1864 served in the middle military and in 1865 was in command of eastern Arkansas division. After the war he received the brevet of major-general in the United States army, and was mustered out of the volunteer service, being made lieutenant-colonel of the Twenty-sixth Infantry; raised to the rank of colonel in 1880; brigadier-general in 1890, and major-general in 1894. General McCook was one of the representatives of the President at the coronation of Czar Nicholas II of Russia.—DANIEL, a fourth son; born in Carrollton, July 22, 1834; graduated at the Alabama University in 1858; studied law, and removed to Leavenworth, Kansas, where he practiced as member of a law firm with William T. Sherman and Thomas Ewing. When the Civil War broke out he became captain in a local regiment; was made chief of staff of the First division of the Army of the Ohio; took part in the battle of Shiloh, and was raised to the rank of colonel. He commanded a brigade in General Sherman's army, and was chosen by Sherman to lead the assault against the Confederates at Kenesaw Mountain in the Atlanta campaign. Upon reach

ing the top of the enemy's works he was shot and mortally wounded. On July 16, 1864, he was promoted to the rank of brigadier-general in the United States Army, but died on the 21st of the same month.—EDWIN STANTON, another son; born in Carrollton, Ohio, March 26, 1837; educated at the United States Naval Academy; entered the Union army at the beginning of the Civil War as captain in an Illinois regiment, of which John A. Logan was the colonel; succeeded Logan in the command of his regiment, brigade and division in the campaign on the Mississippi, at Chattanooga and in Georgia; was brevetted major-general of volunteers in March, 1865; shot and killed in a public meeting in Yankton, South Dakota, Sept. 11, 1873.—CHARLES MORRIS, a sixth son; born in Carrollton, Ohio, Nov. 13, 1843; enlisted as a private, and was killed at Bull Run July 21, 1861.—JOHN JAMES, a seventh son; born in Carrollton, Ohio, May 12, 1845; was a student at Kenyon College at the outbreak of the Civil War; enlisted in the Sixth Ohio Cavalry, and served throughout the war, attaining the rank of captain with the brevet of colonel. After the war he took up the practice of law in New York City. He was consulting attorney for the prosecution in the trial of Dr. Charles F. Briggs for heresy.—JOHN, brother of the first Daniel, and uncle of the others mentioned above; born in Cannonsburg, Pennsylvania, Feb. 21, 1806; graduated at Jefferson College and at the Cincinnati Medical School; practiced medicine in New Lisbon and Steubenville, Ohio; served in the war as surgeon. Died in Washington, Oct. 11, 1865.—His son, EDWARD MOODY; born in Steubenville, Ohio, June 15, 1833, studied law, and went west to the region which is now Colorado, and began practice; enlisted in the Union army and was commissioned second lieutenant in 1861; served in the Mississippi, Chattanooga and Georgia campaigns; was commissioned brigadier of volunteers in 1864, and brevetted major-general in the following year. He resigned from the army in 1866, and was appointed minister to the Sandwich Islands; was selected by President Grant for the governorship of Colorado territory.—Another son, ANSON GEORGE, born in Steubenville, Ohio, Oct. 10, 1835; studied law, and was admitted to the bar; entered the Union army as captain in the Second Ohio Infantry in 1861; fought at Bull Run, in the campaigns of the Army of the Cumberland under Buell, Rosecrans and Thomas, in Sherman's Atlanta campaign, and in the Virginia valley, where he commanded a brigade. He was brevetted brigadier-general of volunteers; was assessor of United States revenue at Steubenville (1865-73); Republican member of Congress from New York (1877-83), and subsequently secretary of the Senate.—Another son, HENRY CHRISTOPHER, American minister and entomologist; born at New Lisbon, Ohio, July 3, 1837. He learned the printer's trade, taught, and afterward went to Jefferson College, Pennsylvania, graduating in 1859, studying theology at the Western Theological Seminary, Allegheny,

Pennsylvania. Enlisted in the Civil War, and served as lieutenant and chaplain, and later held pastorates at Clinton, Illinois (1862-63), in St. Louis, Missouri (1863-70), and in Philadelphia at the Tabernacle Presbyterian Church since 1870. He has been an active worker in the Entomological Society and in the Philadelphia Academy of Natural Sciences, and has published works on scientific subjects, mostly on ants and spiders, and also several religious works. Among them are *The Last Year of Christ's Ministry* (1871); *The Tercentenary Book* (1873); *Mound-Making Ants of the Alleghanies* (1877); *The Natural History of the Agricultural Ant of Texas* (1880); *Honey Ants and Occident Ants* (1882); *American Spiders and their Spinning Work* (2 vols., 1889-90).—Another son, RODERICK SHELDON, born in New Lisbon, Ohio, March 10, 1839; educated at the United States Naval Academy, graduating in 1859; during the Civil War took part in engagements off the coast of North Carolina; fought at both the Fort Fisher battles; retired from the service in 1885. He died Feb. 13, 1886.—Another son, JOHN JAMES, born in New Lisbon, Ohio, Feb. 4, 1843; graduated at Trinity College in Hartford, Connecticut; began the study of medicine, but gave it up for theology and entered the Protestant Episcopal ministry; served for a short time with the Union army in West Virginia; held pastorates in Detroit, Michigan, and East Hartford, Connecticut, and in 1883 was made professor of modern languages in Trinity College. He interested himself in sociological questions, especially those relating to charity, and contributed frequently to the magazines.

MCCORMAC, SIR WILLIAM, a British surgeon, born at Belfast, Ireland, Jan. 17, 1836; was educated in the Belfast Institution, in Dublin and in Paris; saw service at Metz and Sedan during the Franco-German War, as surgeon-in-chief of the Anglo-American ambulance, and in the Turko-Servian War of 1876. He became the senior surgeon and lecturer on surgery at St. Thomas's Hospital, and President Royal College of Surgeons. In 1881 he acted as honorary secretary-general of the International Medical Congress, and was on special service as Consulting Surgeon in South Africa during the Boer war of 1899-1900. He is the author of *Work Under the Red Cross*, and treatises on *Antiseptic Surgery and Surgical Operations*; besides numerous papers contributed to medical journals.

MCCORMICK, CYRUS HALL, an American inventor, born at Walnut Grove, Virginia, Feb. 15, 1809. He was educated in common schools, and worked for his father on the farm and in the workshop. In 1831 he invented his reaper, patenting it in 1834. In 1847 he moved to Chicago and erected harvester-works. He gave \$100,000 to found the McCormick Theological Seminary (Presbyterian) in Chicago, and afterward endowed a chair in Washington and Lee University, Lexington, Virginia. For his invention he was made officer of the Legion of Honor and received other marks of distinction at home and abroad. He died in Chicago, May 13, 1884. See also HARVESTING MACHINERY, in these Supplements.

MCCORMICK'S MACHINES. See HARVESTING MACHINERY, in these Supplements.

MCCOSH, JAMES, a Scotch-American educator; born at Carskeoch, Ayrshire, April 1, 1811; son of



JAMES McCOSH.

a farmer, a graduate in arts of Glasgow University and in theology of the University of Edinburgh in 1834; ordained pastor of a congregation of the Scotch Kirk in Arbroath in 1835; accepted a call in 1839 to Brechin; joined the Free-Church movement in 1843; professor of metaphysics and logic in Queen's College, Belfast, Ireland, 1851-68; studied the higher educa-

tional systems of Germany and the United States in those countries; president of the College of New Jersey at Princeton, 1866-88; president emeritus until his death at Princeton, Nov. 6, 1894.

Among other academic honors, Dr. Cosh was made a doctor of laws by Aberdeen and Harvard universities. He was long known as a metaphysician, and he expounded with ability the philosophy of the common-sense school, giving development to the doctrines of Sir William Hamilton. His principal publications on this subject were *The Intuitions of the Mind Inductively Investigated* (1860, new edition 1875); *Examination of J. S. Mill's Philosophy: being a Defense of Fundamental Truth* (1866 and 1875); *Laws of Discursive Thought* (1869 and 1876); *The Scottish Philosophy* (1874), a historical study; *The Emotions* (1880); and his *Philosophical Series* (1882-86), in eight parts, the last of which is a critical examination of Herbert Spencer's philosophy, and Dr. McCosh developed it into two volumes and brought it out in 1887 as *Realistic Philosophy Defended*. His other publications were a sketch of his friend and teacher, Chalmers, sermons delivered on special occasions, and controversial articles in defense of intuitive philosophy and of fundamental Christian dogma.

As a teacher and director of a great college, he was greatly beloved and trusted. He inculcated a love of truth in a spirit hospitable to the ideas of scientific thinkers, and his example did much to end the senseless practice of denouncing evolution as hostile to a Christian creed. When he took charge of Princeton College it was suffering from the withdrawal of its Southern students caused by the Civil War. He saw the list of students and of instructors more than trebled, the college equipped with new and handsome buildings and its endowment increased to several million dollars.

MCCOY, SIR FREDERICK K., a British scientist; born in Dublin, in 1823. He was educated for the medical profession in Dublin and Cambridge. He made palæontological investigations for Sir Richard Griffith's geological map of Ireland, which were published in 1844 under the title *Synopsis of the Carboniferous Limestone Fossils of Ireland*; was appointed professor in Queen's University, Ireland; in 1852,

was made professor of natural science in the University of Melbourne, Australia. He established the National Museum of Natural History and Geology in Melbourne, and has published for the government of Victoria two works in installments, *Prodromus of the Zoology of Victoria* and *Prodromus of the Palæontology of Victoria*, and has been knighted by the Queen. He has published about one hundred papers on zoological and palæontological subjects.

MCCRARY, GEORGE W., an American jurist and statesman; born Aug. 29, 1835, in Evansville, Indiana. With his parents, in 1836, he went to that part of Wisconsin territory which afterward became the state of Iowa. He was admitted to the bar in 1856, and in 1857 was elected to the state legislature; from 1861 to 1865 was state senator from Keokuk, and chairman of the committee on military affairs. In 1868 he was elected to Congress, and served until March, 1877. In 1876 Judge McCrary introduced in Congress the Electoral Commission Bill, which resulted in the choice of Rutherford B. Hayes as President. When President Hayes formed his cabinet, McCrary was given the war portfolio, which he held two years. He resigned to accept the judgeship of the United States Circuit Court, to which he was appointed in December, 1879. In March, 1884, he resigned his judgeship to become general counsel for the Atchison, Topeka and Santa Fé Railroad Company. He published *The American Law of Elections* (1875). He died in St. Joseph, Missouri, June 23, 1890.

MCCULLOCH, HUGH, an American financier; born at Kennebunk, Maine, Dec. 7, 1808. He was

educated at Bowdoin College, studied law in Boston, and then went to Fort Wayne, Indiana, where in 1835 he became cashier of a branch of the State bank. From 1855 to 1863 he was president of the bank of the State of Indiana, and then became Comptroller of the Currency. In 1865 he was appointed Secretary of the Treasury, and held



HUGH McCULLOCH.

office till 1869. In 1871-78 he was engaged in banking in London; and in 1884 was again appointed Secretary of the Treasury, holding the post till the end of Arthur's administration. He published *Men and Measures of Half a Century* (1888). Died near Washington, D. C., May 24, 1895.

MCCULLOUGH, JOHN EDWARD, an Irish-American actor; born in Coleraine, Ireland, Nov. 2, 1837. In 1853 he went to the United States with his parents, settled in Philadelphia, and was apprenticed to a chair-maker. In 1855 he made his first appearance on the stage in *The Belle's Stratagem*, at the Arch-street theater, and soon afterward chose acting as his profession. In 1866 and 1868 he traveled with Edwin Forrest, acting the second parts in his plays, and when Forrest died in 1872 he left McCullough all his plays in manuscript, considering him as his successor on the stage. In 1869 McCul-

long took the management, with Lawrence Barrett, of the Bush-street theater in San Francisco. His repertoire consisted of *Brutus*, *Jack Cade*, *The Gladiator*, *Virginius*, etc. He died in an insane asylum, Nov. 8, 1885.

MACDONALD, MAJOR SIR CLAUDE MAXWELL, K. C. B., K. C. M. G., late British Minister at Pekin; was born in 1852, and is the son of the late Major-Gen. J. P. Macdonald. He studied at Sandhurst and entered the army as lieutenant in the 74th Highlanders in 1872. He became captain in 1881 and major in 1882, in which part he took part in the battle of Tel-el-Kebir. Was mentioned in despatches and decorated with the Khedive's Star; he also obtained Egyptian medal and clasp. Later on, he was attached to the Suakin expedition, and was in the battles of El-Teb and Tamai, and was wounded in the latter. For a time he was attached by the English war office to the agency at Cairo, and subsequently acted as Consul-General at Zanzibar, and as Commissioner on the West African coast. Later still, he acted as British commissioner on the Niger coast and was consul in the Kamerouns. In 1892 he was created a K. C. M. G., and in 1898 a K. C. B. In 1896, he was appointed Minister to the Court of China at Pekin, where he was beleaguered during the Boxer uprising in 1900 within the British Legation at the capital.

MCCURDY, JAMES FREDERICK, an American oriental scholar; born at Chatham, New Brunswick, Feb. 18, 1847; educated at the University of New Brunswick and at Princeton Theological Seminary; instructor in Semitic languages at Princeton (1873-82); studied in Leipsic and Göttingen (1882-84); lecturer at Princeton (1885-86); afterward professor of oriental languages in the University of Toronto. He is the author of a *Commentary on Haggai* (for Lange-Schaff Commentary on the Bible, 1876); *Aryo-Semitic Speech* (1881); and *The Assyrian and Babylonian Inscriptions, with Special Reference to the Old Testament* (1886).

MACDONALD, FLORA, a Scotch girl who aided Charles Edward, the young Pretender, to escape after the battle of Culloden. She was born in 1722, at Milton, in South Uist, and adopted by Lady Clanranald, who educated her in Edinburgh. In 1746 she conducted Prince Charles, disguised as "Betty Burke, the Irish Woman," from Ormichlade, in Benbecula, to Monkstadt, in Skye, and thence to Portree; and in consequence was arrested by the English authorities and kept prisoner for a year in Leith Roads and in London. After her release she married Allan Macdonald of Kingsburgh, and in 1774 emigrated to North Carolina. Upon the outbreak of the Revolution her husband became a brigadier-general in the British Army, and later was captured by the colonial forces. Flora returned to Scotland in 1779, and two years later was joined by her husband and settled in Kingsburgh. She died March 5, 1790, and was buried at Kilmuir, where in 1880 an Iona cross of Aberdeen granite, 28½ feet high, was erected over her grave.

MACDONALD, GEORGE, a Scottish novelist and poet; was born at Huntly, Aberdeenshire, in 1824,

and educated at Aberdeen University and the Independent College, Highbury, London, where he studied for the ministry.

He preached for a time in Sussex and at Manchester, as a Congregationalist, but shortly afterward retired from the ministry and became a lay member of the Church of England. His tastes from the first were literary, his work has always been deeply tinged by broad theological views, though he retained his early fervor and deep spiritual instincts. Many of his stories are strongly conceived, and abound in religious dialogue, cast in the mould of Scottish dialect but softened by the author's poetic moods and tender emotions. He is particularly happy in addressing or treating of children, both in his poems and prose allegories. Of these, perhaps the best are *Dealing With Fairies* (1867); *At the Back of the North Wind* (1873); and *The Princess and the Goblin* (1871). *The Disciples, and Other Poems* (1868) and the fuller collection of his *Poetical Works* (2 vols., 1893) contain much thoughtful and finely expressed verse. Not only as a novelist but as a lecturer, Mr. Macdonald is well known in the United States. In 1877 he received a pension of £100 sterling from the Civil List in acknowledgment of his services to literature. The more important of his novels are as follows: *David Elginbrod* (1862); *Alec Forbes* (1865); *Annals of a Quiet Neighborhood* (1866); *Scaboard Parish* (1867); *Robert Falconer* (1868); *Sir Gibbie* (1869); *Wilfred Cumbermede* (1871); *The Vicar's Daughter* (1872); *Malcolm* (1874); *St. George and St. Michael* (1875); *Thomas Wingfold, Curate* (1876); *Marquis of Lossie* (1877); *Paul Faber* (1878); *What's Mine is Mine* (1886); and *There and Back* (1891). Mr. Macdonald has also published three volumes of a religious character: *Unspoken Sermons* (1885); *The Miracles of our Lord* (1884); and *The Hope of the Gospel* (1892). He has also issued a collection of *Essays* (1893).

MACDONALD, SIR JOHN ALEXANDER, Canadian statesman, was born at Glasgow, Scotland, Jan. 11, 1815. His father, a Sutherlandshire man, brought him to Canada in 1820, and settled near Kingston, then the most important town in Upper Canada. Here young Macdonald was educated at the Royal Grammar School, and in his sixteenth year was articled to the law and in due course was admitted to the bar. During the rebellion of 1837 he brought himself into note by his defense of a Pole named Von Shoult, who had been con-



GEORGE MACDONALD.



SIR JOHN A. MACDONALD.

cerned in giving aid from the American side to the Canadian rebels. The era succeeding the rebellion is the turning-point in the political history of the Canadas. It is the era in which reform was to see its work crowned in the overthrow of the oligarchical "Family Compact," in the application of the elective principle to the irresponsible legislative council, and the full attainment of responsible government in the colony. It was at this period (1844) that Sir John Macdonald entered political life, and by his abilities and readiness in debate gained that commanding position in Canadian politics, at the head of the Conservative party, which secured him in later years a long lease of power. Macdonald attained office, first as Receiver-General and afterward as Commissioner of Crown Lands. Questions of grave moment were then agitating the country, including the cry for representation by population, for the secularization of the clergy reserves, for the abolition of seigniorial tenure, and compensation for rebellion losses. These were followed a little later by the agitation over the seat of government, which brought with it the episode of the Brown two-days administration and its Tory pendant, the "double-shuffle," an evasion of the constitutional rule which requires ministers on taking or resuming office to go to their constituencies for re-election. After an experience in opposition, Mr. Macdonald became Attorney-General in the coalition government of 1854, and two years later assumed the Premiership. His political fortunes varied considerably down to the period of confederation, which was brought about by a deadlock of parties, the contest being one of race and religion as well as of faction-strife. The chief credit in founding the new nation and knitting together under one federal government the various sections of what now forms the Canadian Dominion, is due to Sir John. Naturally, when the Union was consummated in 1867, he became Premier, and acted as Attorney-General and Minister of Justice, while the seat of government was permanently located at Ottawa. With confederation there passed away, in some measure, the enfeebling sectional rivalries which had so long retarded the progress of the country and exercised a baneful influence on politics. The area of the country was at this epoch largely extended by the accession of the vast territory that for two hundred years had been under the sway of the Hudson Bay Company. With the acquisition of the northwest and the entrance of British Columbia into the Confederation, there came the need of railway construction to connect the Pacific colony with its partners in the east. At first, political difficulties brought a crisis upon the country, in which Sir John Macdonald's administration fell, in 1873, owing to its being implicated in corrupt dealings with the proposed contractors for the railroad. In 1878, however, he regained power, and continued until his death in 1891 at the head of his own Liberal-Conservative administration. His return to office was brought about, in the main, by a change of economic policy and the

initiation of a system of protection to native industries. In the course of his premiership, Sir John Macdonald was repeatedly called upon by the Imperial country to take part at Washington in matters of state policy and in the settlement of international questions between England and the United States. In 1871 he acted as one of the high commissioners in the settlement of the Alabama Claims and the initiation of the Washington Treaty of that year. He was one of the delegates from Canada in 1866 who took part in the drafting of the British North America Act, and he visited London in 1880 to arrange with the Imperial authorities the terms for the construction of the Canadian Pacific Railroad. Four years later he also visited London to take part in the discussion of the question of Imperial Federation, in which he was a prime mover. In 1867 he was created a K.C.B.; in 1879 he was sworn a member of the Imperial Privy Council; and in 1884 received the decoration of the Grand Cross of the Bath. Sir John possessed in a remarkable degree the art of governing, and though his political methods were often open to criticism, he has left an indelible impress upon the country he loved. At his death Lady Macdonald was created a Baroness in consideration of her husband's distinguished services to the crown. He died in Ottawa, Canada, June 6, 1891.

G. MERCER ADAM.

MACDONALD, JOHN DENIS, a British physician; born Oct 26, 1826, and educated for the medical profession in the Cork School of Medicine and at King's College, London. In 1852 he was appointed to *H. M. S. Herald* in its exploring expedition in the Pacific; in 1859, to the *Icarus*; in 1880, inspector-general of hospitals; retired in 1886. Among his works are *Sound and Colour* (1869); *Guide to Microscopical Examinations of Drinking-Water* (1875); and *Outlines of Naval Hygiene* (1881).

MACDONALD, JOHN HAY ATHOLE, a Scotch jurist and author; born Dec. 27, 1836; educated at the Universities of Edinburgh and Basel; became advocate (1859); Queen's counsel. (1880); solicitor-general for Scotland and commissioner for northern light-houses (1876-80); and Lord Advocate of Scotland (1885-88); sat in Parliament for Edinburgh and St. Andrew's universities (1885-88). He was made member of the Institution of Electrical Engineers in 1886. He is an authority on criminal law and on infantry drill, and has published *Macdonald on Tactics*; *Treatise on the Criminal Law*; *Our Trip to Blunderland*; and *Common Sense on Parade*.

McDONOGH, JOHN, an American philanthropist; born in Baltimore, Dec. 29, 1779. He engaged in mercantile business in Baltimore; in 1800 moved to New Orleans, where he soon accumulated a fortune in the commission and shipping business, and founded the town of McDonoghville, Louisiana. In 1822 he began paying his slaves wages, and allowed them, with the money thus received, to purchase their freedom for a moderate



sum. He also became vice-president of the American Colonization Society. At his death he left the bulk of his property, amounting to \$2,000,000, to the cities of New Orleans and Baltimore, for the purpose of founding free schools. In 1873, after many years of litigation, land was purchased near Baltimore and the McDonogh labor schools were established, at which seventy boys are instructed annually. In New Orleans the principal of the legacy was invested in schools, which are conducted, in connection with the public schools, by the city. He died Oct. 26, 1850, and his biography came from the pen of William Allan, under the title of *The Life and Work of John McDonogh* (1886).

MACDONOUGH, THOMAS, an American naval officer; was born in Newcastle, Delaware, Dec. 23, 1783. He entered the navy as midshipman in 1800; served in Tripoli under Decatur; was promoted lieutenant in 1807, and master-commander in 1813. In August, 1814, he gained a victory over a British fleet under Captain Downie, on Lake Champlain, for which he received a gold medal from Congress and numerous civic honors from cities and towns. The Mediterranean squadron was his last command. He died on his homeward voyage, Nov. 16, 1825.

MCDUGALL, WILLIAM, a Canadian statesman; born in Toronto, Jan. 25, 1822; was educated at Victoria College; studied law, and was admitted to the bar in 1847. In the following year he established the *Canada Farmer*, which later was changed to the *Canadian Agriculturist*; and in 1850 founded the *North American*, which was absorbed in the *Toronto Globe* in 1857, on the staff of which he was employed until 1859. He was a member of the Canadian Assembly from 1858 to 1867; of the Dominion Parliament from 1867 to 1872, and from 1878 to 1882. In the first Dominion government he was Minister of Public Works, holding the office until 1869, when he was appointed lieutenant-governor of the Northwest, but rebellion barred him from the territory.

MCDOWELL, IRVIN, an American general; born in Columbus, Ohio, Oct. 15, 1818. He was educated at the College of Troyes, France, and graduated at West Point in 1838, entering the artillery. He served on the Canadian frontier during the disturbances which occurred before the settlement of the northeast boundary dispute; was instructor at West Point (1841-45); in the Mexican War was on the staff of General



GEN. IRVIN MCDOWELL.

Wool, and became his acting adjutant-general; was made captain in 1847; after the war, was assistant adjutant-general in New York and Washington; promoted to major (1856); at the breaking out of the Civil War was aide-de-camp on Scott's staff; in May, 1861, was made brigadier-general

and given command of the Department of Northeastern Virginia. On May 29th he received command of the Army of the Potomac, consisting of 30,000 raw recruits. With these he advanced against the enemy under Beauregard, and the first battle of Manassas or Bull Run (q.v.) was fought July 21. In 1862 McDowell was placed in charge of the First Corps of the reorganized Army of the Potomac, afterward detached as the Army of the Rappahannock, and raised to the rank of major-general of volunteers, McClellan having the chief command. In the summer of 1862 his force was added to General Pope's Army of Virginia, and he participated in the campaign which followed in northern Virginia. After this he was retired from service in the field, and in 1864 was placed in command of the Department of the Pacific; in 1865, of the Department of California; and in the following year brevetted major-general in the United States Army; in 1868 he was placed in charge of the Department of the East; in 1872 made major-general, and afterward placed in charge, successively, of the Divisions of the South and West. He was retired in 1882, and died in San Francisco, May 4, 1885.

MCDUFF, JOHN ROSS, a Scotch minister and author; was born at Bonhard, Perthshire, in 1818; educated at the University of Edinburgh; ordained in 1843; held pastorates in Kittens, Forfarshire (1843-49); in St. Madoes, Perthshire, (1849-55); and in Glasgow, in the church of Sandyford, (1855-57). After the latter year he lived in retirement at Chiselhurst, Kent, until his death, April 30, 1895, and devoted himself to literary labors. His works were mainly on religious subjects, and have had a large circulation in England, Scotland and America. Among them were *The Wells of Baca* (1847); *Memories of Bethany* (1857); *The Parish of Taxwood* (1884); and *Knocking* (1872). In all, they numbered nearly one hundred.

MCDUFFIE, GEORGE, an American statesman; born in 1788, in Columbia (now Warren) County, Georgia. He was admitted to the bar in 1814, and in 1818 was sent to the South Carolina legislature. In 1821 he was chosen to Congress, and served until 1834. He then was elected governor of the state, which office he held till 1836, when he retired to private life. From 1842 to 1846 he was a United States Senator. He published, besides numerous addresses, a *Eulogy on Robert Y. Hayne* (1840). He died March 11, 1851.

MACE. See NUTMEG, Vol. XVII, p. 666; and OILS, Vol. XVII, p. 744.

MACÉ, JEAN, a French editor and *littérateur*; born in Paris, April 22, 1815. His parents were laborers, but he was sent to the College Stanislas, and in 1836 had charge of a class in history at that institution; served in the army (1842-45); was secretary to Théodose Burette, his former professor of history (1845-47); editor of *La République* in 1848. After the *coup d'état* he retired to Beblenheim, in Alsace, and taught school; in 1864 founded and edited, with M. Stahl, *Le Magasin d'Éducation et de Récréation*. In 1880 he was decorated with the cross of the Legion of Honor,

and in 1883 elected to the French Senate. M. Macé was the author of a number of books, mostly of an instructive sort, for children. Among them are *Histoire d'une Bouchée de Pain* (1861); *Contes du Petit-Château* (1862); *Arithmétique du Grand-Papa* (1863); *L'Anniversaire de Waterloo* (1868) and *La France Avant les Francs* (1881). He died Dec. 13, 1894.

MCENTEE, JERVIS, landscape-painter; born at Rondout, N. Y., July 14, 1828; began the study of art in New York, under F. E. Church, about 1850; in 1861 was elected member of the Academy; visited Europe in 1869. He endeavored to portray certain somber phases of nature, his work being tinged with melancholy. Among his best-known canvases are *Indian Summer*; *The Melancholy Day*, which led to his election to the Academy; *November*; *October Afternoon*; *The Kaatskills in Winter* (1884); *Christmas Eve* (1885); and *Shadows of Autumn* (1886). Died at Rondout, N. Y., Jan. 27, 1891.

MACEO, ANTONIO, a Cuban mulatto general; born near Barajagua, in Santiago de Cuba, July 14, 1848. He and his brother José, who was killed in battle, July 5, 1896, enlisted under Gomez, and fought through the ten years' war, 1868-78, attaining the rank of major-general of cavalry. In 1873 he defeated General Weyler at Guimaro. After the pacification of Zanjon he fought on until compelled to surrender. Escaping from Cuba, he took refuge in Costa Rica, whence he returned in 1888 to Santiago to foment a fresh insurrection. Failing in this he fled again, but on the outbreak of the revolt of February, 1895, he and his brother hastened to join the forces of his old commander, Gomez. He participated in the warfare, leading his troops into the province of Pinar del Rio, from which Weyler could not dislodge him. In a skirmish near Mariel, on Dec. 2, 1896, he received mortal wounds, and died on the field of battle.

McFALL, MRS. FRANCES ELIZABETH (CLARKE), an English novelist, writing under the pseudonym, "Sarah Grand"; born at Donaghadee, in the North of Ireland, of English parents. After the death of her father, which occurred when she was very young, her mother settled in Yorkshire, and she was sent to school, first at Twickenham, and later in Holland Road, Kensington. At sixteen she married an army officer, and afterward accompanied him to Ceylon, China and Japan. She began writing when she was very young, her first published story appearing in *Aunt Judy*, a girls' magazine. After this she wrote the highly overstrained and rather improbable novel, *Singularly Deluded*, which was published by Messrs. Blackwood. In 1888 appeared her *Idcola*, a problem story, treating of the marriage question, and a sort of prelude to her *Heavenly Twins*, which appeared in 1893. *Idcola* was refused by the publishers, and printed at the author's own expense. The *Heavenly Twins* fared in the same manner; but, after it had already come from the press, the risk of its publication was assumed by the printer. The novel, despite its three volumes

and its didactic purpose, was immediately successful. The book, written in a desultory style, with much description and little continued action, is intended as a protest against the injustice of society which permits or ignores lapses from morality before marriage on the part of the man, but metes out its severest condemnation for such on the woman. She published in 1894 a collection of her shorter stories under the title, *Our Manifold Nature*.

MACFARREN, SIR GEORGE ALEXANDER, an English composer; born in London, March 2, 1813. He studied at the Royal Academy of Music, where he became professor of harmony in 1838. In 1875 he was appointed principal of the academy, and also professor of music at Cambridge University. He was knighted in 1883. During the greater part of his life Dr. MacFarren was blind, but continued to perform the duties of his various positions. His compositions were dictated to his wife. His first important work, a *Symphony in F Minor*, was produced in 1834. Two years later appeared his overture, *Chevy Chase*; and in 1838 his first work for the stage, *The Devil's Opera*. Among his best-known compositions are the cantatas *Leonora* (1851), and *May Day* (1856); *John the Baptist* (1873), and *The Resurrection* (1876), oratorios; the operas *Don Quixote* (1846), *Charles II* (1849), and *Robin Hood* (1860), besides a great number of songs, sacred and secular. He wrote much upon the theory of music, and published in 1860, *Rudiments of Harmony*. He died Oct. 31, 1887.

MACGAHAN, JANUARIUS ALOYSIUS, an American newspaper correspondent and author; born near New Lexington, Perry County, Ohio, June 12, 1844; worked on his father's farm, taught school, and in 1864 went to St. Louis, Missouri. Here he wrote news-letters to the *Huntington Democrat*. In 1869 he went to Europe, and in 1870 was engaged as the New York *Herald* special correspondent. As such he followed General Bourbaki on his retreat in the Franco-Prussian War, and accompanied the Russian expedition against Khiva in 1873, publishing his experiences under the title of *Campaigning on the Oxus and the Fall of Khiva* (1874). In 1874 he went to Spain to report the Carlist war, and in the following year accompanied Captain Allen Young on his voyage in the *Pandora* to the Arctic seas. In 1876 he became the correspondent of the *London Daily News*, and wrote, for that paper, accounts of the Turkish massacres in Bulgaria, and later the events of the Russo-Turkish War. He published, besides the work mentioned, *Under Northern Lights* (1876), an account of his Arctic voyage; and *Turkish Atrocities in Bulgaria* (1876). He died in Constantinople, June 10, 1878.

MCGEE, THOMAS D'ARCY, an Irish-Canadian politician; was born at Carlingford, Louth, Ireland, April 13, 1825. For a time he was editor of the Boston (Massachusetts) *Pilot*, and then went to Ireland, where he was employed on the staff of the *Dublin Freeman's Journal*, and later of *The Nation*. He became involved in the

"Young Ireland" movement, and was obliged to flee to America; in 1848 established *The American Celt*, and then *The Nation*. Subsequently his opinions changed, and he became an ardent Royalist, moved to Canada, and established a paper called the *New Era*. In 1857 he was chosen to the Canadian Parliament, and from 1864 to 1867 was president of the executive council. He made himself obnoxious to the members of the Fenian society, and on the evening of April 7, 1868, when returning from a night session of Parliament, he was assassinated at the door of his hotel. He published *Historical Sketches of O'Connell and His Friends* (1845); *Life of Edward McGinn* (1857); *Canadian Ballads* (1858); and *Popular History of Ireland* (1862).

MCGILL, JAMES, a Canadian philanthropist; born in Glasgow, Scotland, Oct. 6, 1744. He emigrated to Canada before the American Revolution, engaged for some time in the Northwest fur trade, and subsequently settling in Montreal, became a successful merchant there. He was for many years a member of the Lower Canada Assembly, and subsequently a member of the legislative and executive councils. He bequeathed to the college in Montreal, which bears his name, property valued at £30,000 and £10,000 in money. He died in Montreal, Canada, Dec. 19, 1813.

MCGILL UNIVERSITY, Montreal, Canada, was founded in 1821 with funds (\$50,000) bequeathed by James McGill, a Montreal merchant who was engaged in the Northwest fur trade, and for a time was under the control of the Royal Institution for the Advancement of Learning. In the year named it obtained a separate charter, of which repeated modifications and extensions have been made. Donations to McGill College and University, since its foundation, amounted in 1894 to \$2,184,961, of which \$447,424 was represented by grounds and buildings, and \$120,423 by other property, while \$1,501,291 was invested for revenue. During the year 1893-94 the fees amounted to \$25,614; the income from investments to \$72,478, and donations and subscriptions to \$12,197. The institution bears the relation to the English and Protestant population of the province of Quebec that the University of Toronto bears to the more homogeneous population of the Province of Ontario. Sir J. William Dawson, the geologist, was the principal of McGill from 1855 to 1893.

MCGLYNN, EDWARD, an American clergyman; born in New York City, Sept. 27, 1837. In 1860 he was ordained to the Roman Catholic priesthood, and in 1866 became pastor of St. Stephen's Church in New York City. In 1886, on



EDWARD M'GLYNN.

account of his ignoring the papal demands to

appear at the Vatican on a charge of supporting Henry George's single-tax theories and opposing the establishment of parochial schools, he was excommunicated. In 1887 Dr. McGlynn became president of the Anti-Poverty Society, and in behalf of his economic opinions he lectured widely. In the latter part of 1893 he was reinstated in his clerical functions. He died at Newburg, N. Y., Jan. 7, 1900.

MACGREGOR, a city of Clayton County, northeastern Iowa; on the Mississippi River, 55 miles above Dubuque, and on the Chicago, Milwaukee and St. Paul railroad. It has good schools and manufactories of wagons, carriages and windmills and railroad repair-shops. It has large grain and live-stock interests. It has a picturesque situation, and is near the highest point on the Mississippi River. Population 1890, 1,160; 1900, 1,498.

MACGREGOR, JOHN, an English canoe-traveler and author; born at Gravesend, Jan. 24, 1825. He was educated at Trinity College, Dublin, and at the college of the same name in Cambridge; traveled in Europe and the East; studied law, and was admitted to the bar in 1851. During the greater part of his life he traveled in Europe, Asia and America, making frequent canoeing expeditions. His books, written under the pseudonym "Rob Roy," are records of his experiences. Among them are *Our Brothers and Cousins: a Tour in Canada* (1859); *The "Rob Roy" on the Baltic* (1866); *A Thousand Miles in the "Rob Roy" Canoe* (1867); and *The "Rob Roy" on the Jordan, Nile and Red Sea* (1874). He died at Bournemouth, England, May 16, 1892.

MACHÆRODONT FOSSILS. See MAMMALIA, Vol. XV, p. 435.

MACHAON. See SURGERY, Vol. XXII, p. 674.

MACHIAS, a town and the capital of Washington County, southeastern Maine, on Machias River, at the head of navigation, 70 miles E. of Bangor. It is a port of entry, and contains a custom-house, foundry, sash-and-blind, factory and many good schools. Lumbering and ship-building are important industries. It has regular boat communication with Portland and Rockland. There is a stage line to Ellsworth. Population 1890, 2,035; 1900, 2,082.

MACHINE AND RAPID-FIRE GUNS. See GUNMAKING, Vol. XI, pp. 285-288; GUNNERY, and GUNMAKING, in these Supplements.

\*MACHINE TOOLS.—SPECIAL FORMS. Machine-tools, in modern times, have assumed such innumerable forms, and are constructed for so many peculiar and special purposes, that it would be impossible here to describe, or even catalogue, so much as simple representative types. The inventiveness of the Anglo-Saxon, and especially of the American, mechanic has produced wonderfully efficient machines of these as of all other classes; and in spite of the high cost of labor and material in the United States, their perfection has become such, and their production so large, and at so small a cost—in consequence of the application

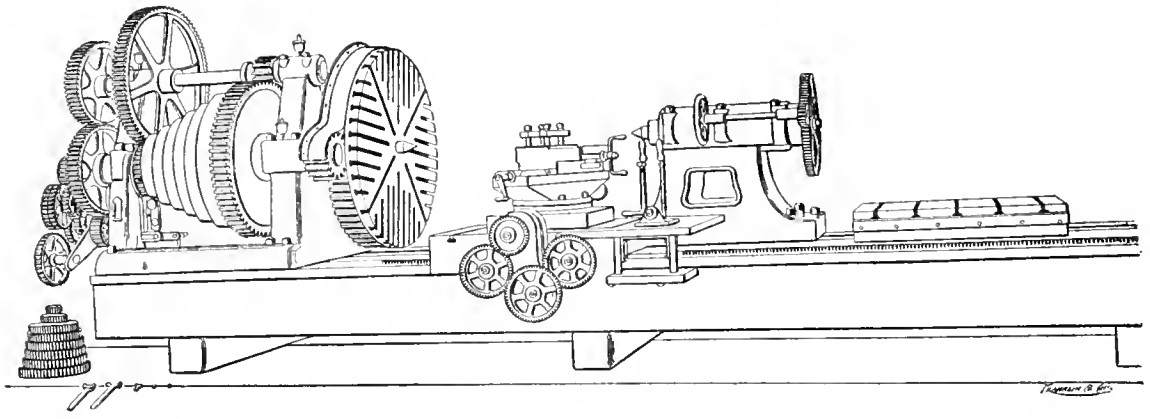

72" LATHE.—SCREW-CUTTING AND TURNING, WITH SCREW-FEED.

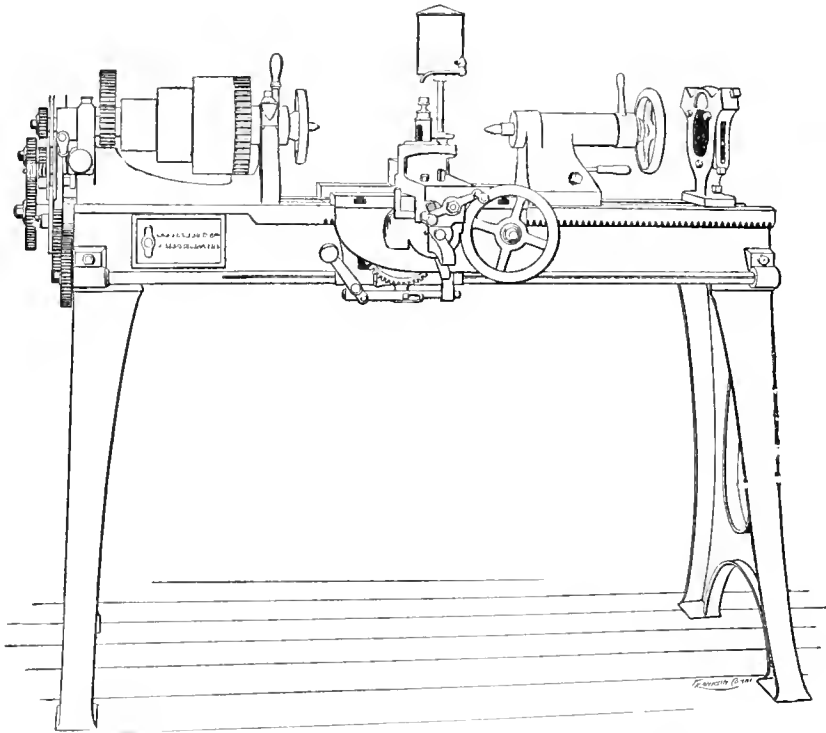

SELF-ACTING SLIDE-LATHE.—TURNING AND SCREW-CUTTING FEEDS.

of special tools to their manufacture, and in consequence, also, of the general employment of the piece-work and gauge-work systems—that American tools of these classes are sent into the markets of Europe and throughout the world. Although this exportation has only recently become important, the total exports in 1891 amounted to nearly \$20,000,000. The article on MACHINE-TOOLS, (Vol. XV, pp. 152-157), gives a very complete and symmetrical account of the general subject, and only special cases need be studied here,—such as illustrate that peculiar talent which only the born inventor and mechanic exhibits, and which now appears everywhere, thanks to a century of wise support of well-conceived patent laws in the United States, and in less degree, usually, in other countries, as well

as to the native genius for invention and the demand consequent upon the high price of labor.

In every branch of manufactures the man and his tool are to-day one, and the desirability of adapting a tool to every purpose in construction is constantly adding to the already enormous list of these special tools. New inventions bring in new wants; and, new wants satisfied, multiplied numbers of other desires arise, to be similarly met by still more ingenious and novel and useful devices. The gun-manufacturer first illustrated these points; then the tool-makers supplied themselves with special tools for their own work; then sewing-machines were made on the piece-work system; then the larger machines came to be similarly built, and even locomotive and stationary engine manufacturers adopted the method of

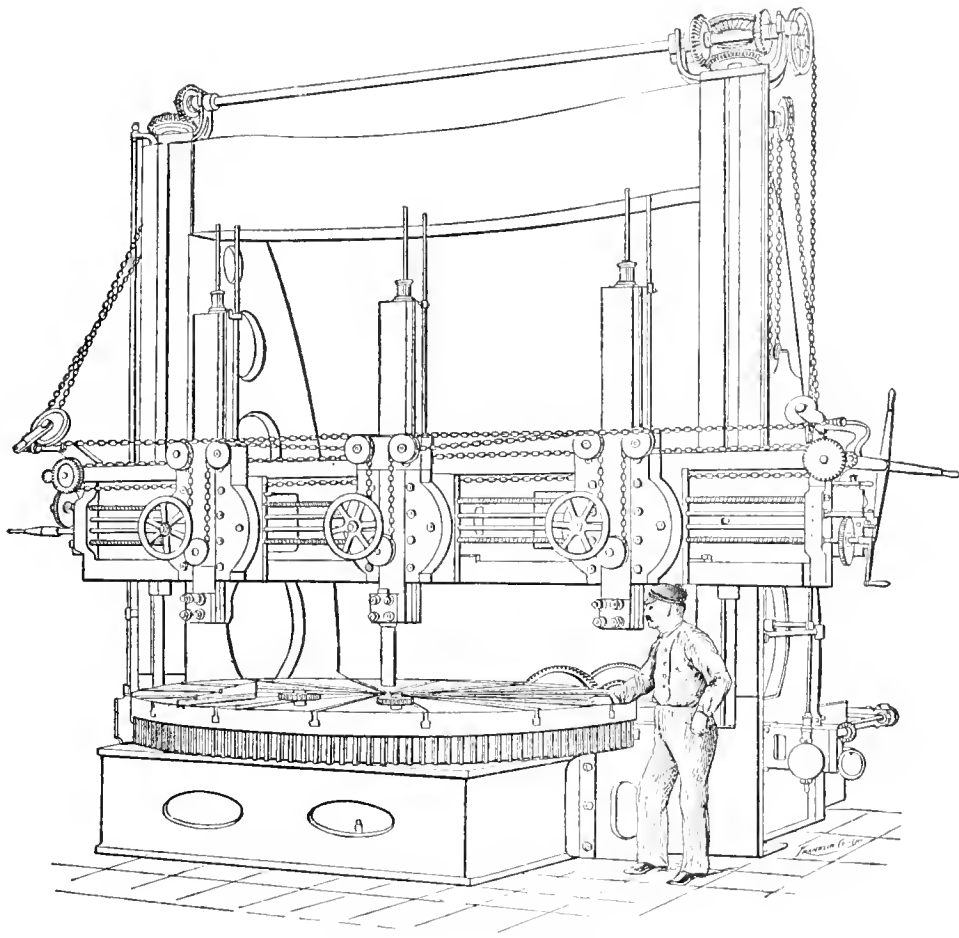

12-FOOT BORING AND TURNING-MILL, WITH THREE SADDLES.

manufacturing in quantity, with all parts interchangeable, and of assembling complete machines as ordered, one or a dozen, as required, from the miscellaneous stock accumulated, all parts fitting accurately,—much more accurately, in fact, than was usual under the older system of making each machine complete by itself. Mechanics have become accustomed to working to gauge, and within limits measured by the thousandth or the ten-thousandth of an inch, and “tight fits” and “easy fits” are readily and certainly secured, where desired, varying the one from the other by the forty-thousandth of an inch. Every available form of natural power, and every possible method of application of mechanism, conspire to reduce costs of manufacture through the use of special tools. Meantime the value, and naturally the price, of skilled labor steadily rises. Steam, water, gas and electricity have more and more come to be substituted for simple manual strength, and more and more this leaves the brain at liberty to devote itself to its higher work.

The continually increasing employment of iron, and especially of steel, in constructions of every sort is stimulating improvement as constantly in the adaptation of the machine-tool to its tasks.

while the steady rise in value of labor is stimulating as continually the inventor and the designing engineer to greater and greater improvement.

The international jury of 1876, at Philadelphia, commenting on the work of one maker of these tools, said: “This exhibit, when considered in regard to its extent and value, its extraordinary variety, and its general excellence, and also for the large amount of ingenuity displayed in the numerous new devices that are introduced, is probably without a parallel in the past history of international exhibitions, and, taken as a whole, it is worthy of the highest honor that can be conferred. Every single machine-tool or piece of apparatus that is displayed in this vast offering would, for itself, command the strongest recommendation for an award, even if it stood alone as a unit; but here every unit is surrounded by thirty-three distinct machines, each one being of the highest standard in its particular class. All of these machines are characterized by extreme refinement in every detail, by the superior quality of the material employed in their construction, by first-class workmanship, both in regard to nicety of fitting and precision, and for the mathematical accuracy of all the parts, by the beautiful outlines that are imparted to each structure.

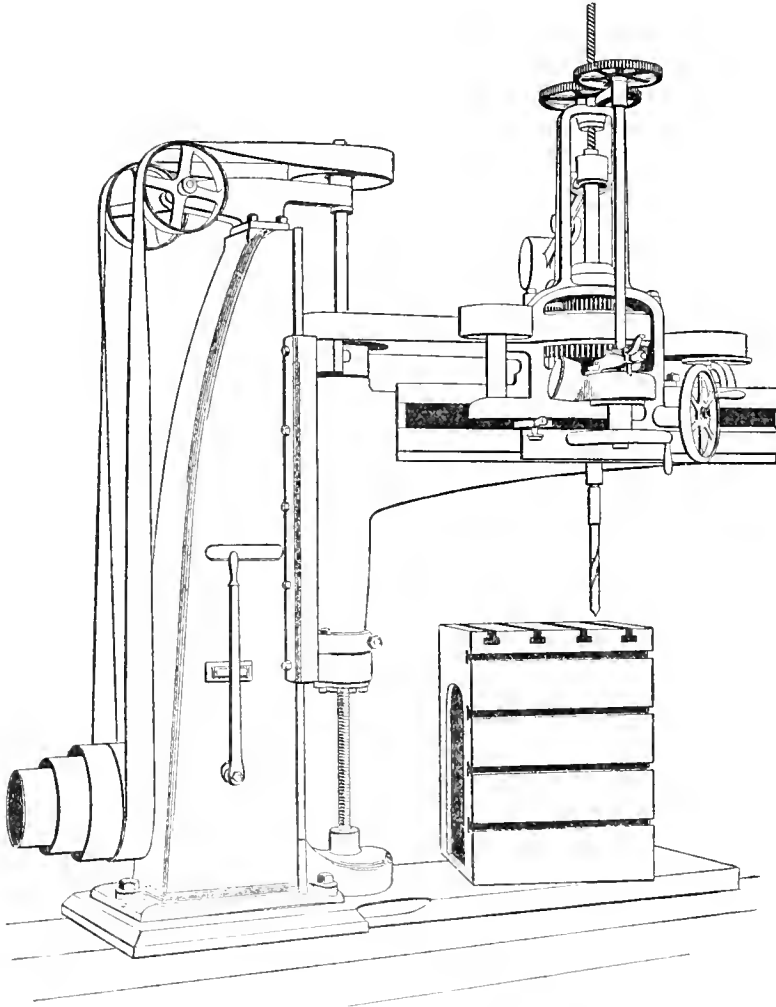

FIFTY-FOUR INCH RADIAL DRILLING MACHINE.

by the correct proportions that have been worked out in the determination of strength and form, and the disposal of material to take full share of duty."

Bolt and nut screwing machines are an humble but peculiarly important class of special tools. They are now built in such manner that, with dies revolving and bolt or nut stationary, the thread may be cut at a single operation; the work being chucked automatically in a precisely central line; the dies closing and opening automatically; the cutting-edge of the tool being automatically and continuously flooded with lard or other organic oil, which constantly circulates in great volume; the adjustments being arranged for fitting precisely to any standard thread, and stops, terminating the operation of cutting, at the desired instant. The attendant simply supplies the blanks and takes away the finished bolt or nut. Such tools, at speeds of 200 to 300 revolutions per minute, make 200 to 3,000 machine-bolts a day, according to size and length.

"Drill-presses" are made with automatic and variable feeds, automatically stopped when the work is complete, with smooth and easily adjust-

able speeds and feeds, positive and strong, yet delicate enough to permit the safe use of the smallest drills, and stiff enough to give absolute accuracy of operation, without loss of line by spring of parts or of frame. "Gang-drills" are made for cases in which a number of holes may be drilled at once, as in drilling rivet-holes, their pitch and size being readily and accurately adjustable to the requirements of the moment. "Radial drills" are among the most useful of these tools. They have a strong, and especially a stiff, upright, on which is swiveled an arm carrying the drill in a sliding and adjustable head, capable of being fed along the radial line, while the arm itself is capable of vertical motion the full height of the main column, and of swinging through a wide angle, thus permitting the setting of the drill upon any point within its field of operation with ease and exactness. Frequently, also, the drill may be set at any desired angle with the vertical, and thus be adjusted to reach out-of-the-way and inclined lines of proposed holes. The machine is fitted by the best makers with all the automatic and changeable speed and feed devices that are found on the common

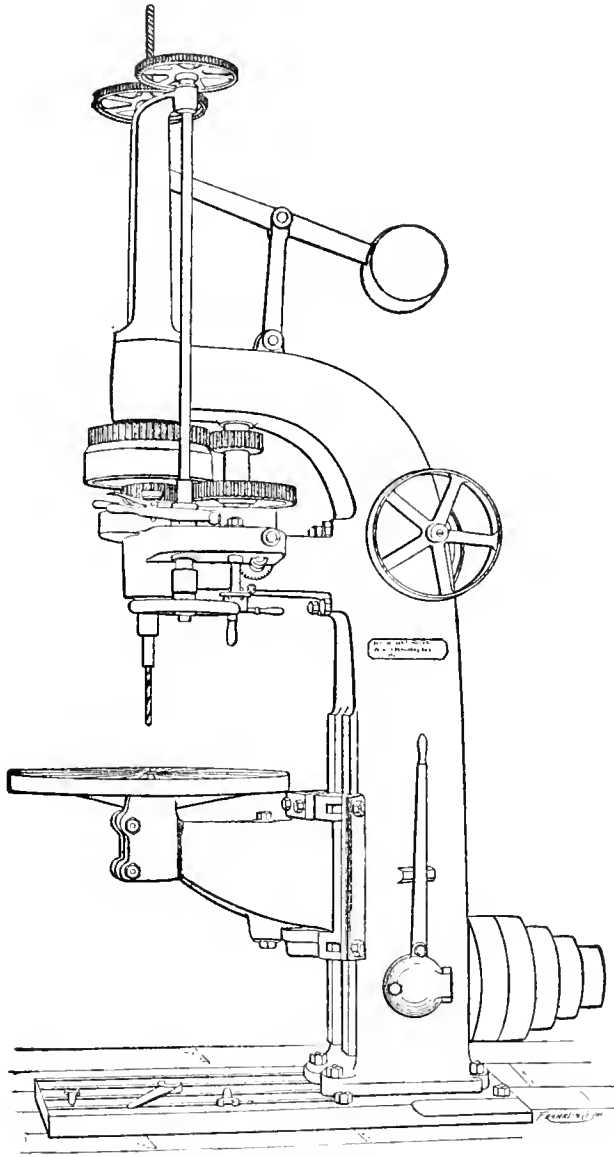

DRILL-PRESS.

**upright drill.** Horizontal boring and drilling machines are made in great variety for special purposes, as are large boring-mills with a fixed boring-bar and horizontal revolving-table. The "Universal" drilling-machine is one which is capable of all the motions, and of taking every set of drill, vertical, inclined, even often inverted, that is required in the shop.

The "locomotive cylinder facing and boring machine," a tool of first rank among these tools of precision, performs all the work of boring, facing off the ends, and thus mainly finishing the locomotive steam-cylinder. As an international jury has said, "this grand tool is an embodiment of all the 'tool-virtues' that can be enumerated, resulting in the transmission of mathematical truth and accuracy to the work performed, combined with great rapidity of execution and consequent economy, thus realizing

the highest ideal conditions." Such machines perform this work on a single cylinder in three hours or less, where, formerly, it demanded, with standard general tools, nine to ten or even twelve hours. The heavier boring-mills of the horizontal class are often fitted with two, and sometimes with three, tool-holders on the great cross-head, and are used for simultaneous boring at the center and turning on the face or on the edge of the work revolving on the table of the mill. They take very heavy cuts on large work, and do an immense amount of work in a very short time. They are sometimes made with tables ten feet in diameter.

The special forms of turning and screw-cutting lathes are very numerous, and vary in size from the little watchmaker's lathe, turning pieces too small to be handled safely, except with the most sensitive and delicately trained touch, to the gun

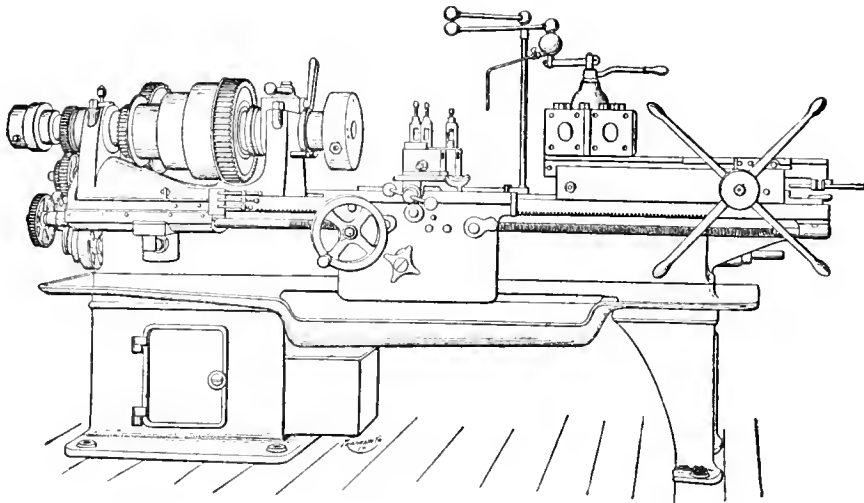

TURRET LATHE.

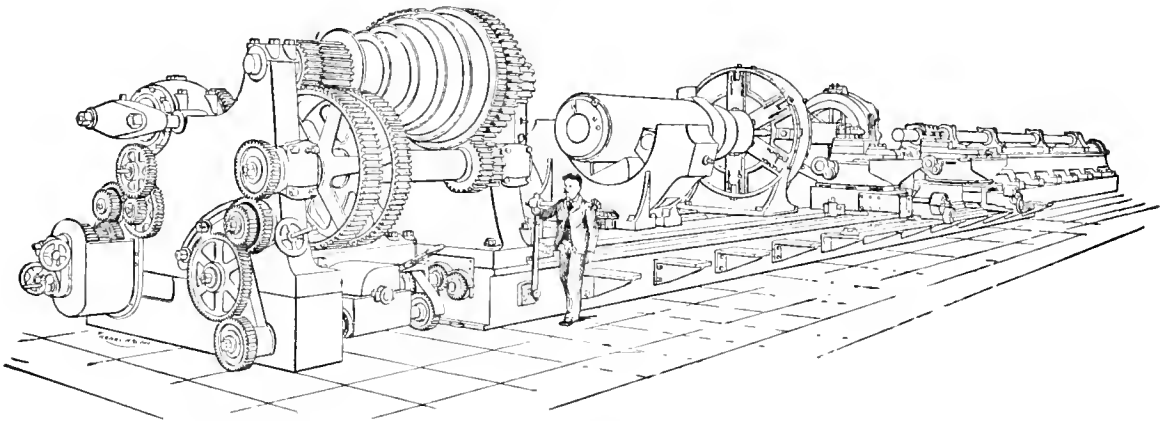

LATHE FOR TURNING AND BORING 16-INCH RIFLES, WATERVLIET ARSENAL. TOTAL LENGTH 138 FEET; FINISHED WEIGHT, 560,000 LBS.

lathe for large ordnance, weighing 250 tons and measuring 125 feet or more in length. A good lathe produces true circles, accurate cylinders, and perfect meridional planes. It has smooth and widely adjustable ranges of speeds, automatic and accurate feeds similarly adjustable, and reliable driving and lubricating mechanisms.

The special forms of "milling-machine" now in use, and in constantly growing employment, are found, for the purposes of the piece-work and gauge-work systems of manufacture, perhaps the most useful of all machines of this department. They have the advantages, where applicable, that, unlike the planing-machine, their work is never intermitted; they cut with numerous tools at the same time; they may be adapted to the production of any right-lined and of some special forms; they hold their work firmly, and yet permit ready and rapid substitution of a new for a finished piece. With these tools, a very large proportion of work like that on guns, sewing-machines and large horological work is now performed with great economy, as compared with the costs of the same kinds of work on the planing-machine. By

thus adapting special tools to special work, the cost, for example, of an army rifle is reduced to one half that of the same gun made under the less efficient system of earlier times.

The power and work of such tools vary greatly. Iron and steel offer a resistance to cutting of from 100,000 pounds upward, sometimes reaching a half-million pounds, or even more; heavy planers remove 50 pounds of metal an hour per horse-power applied, some attaining a product of 1,000 pounds per hour. Speeds vary from a minimum of 6 feet a minute on steel tires, to 15 feet on common soft iron and steel, 20 feet on bronzes and brasses, and up to much higher figures with special provisions for lubrication of the tools, or with self-hardening or other peculiarly durable metal in the cutting-edge. From 40 to 60 feet represent maxima in various kinds of special work. Engine-lathes require from an eighth to a quarter of horse-power to drive them, in ordinary practice. Very large lathes may demand 2 to 5 horse-power, and heavy planers sometimes demand 10 or 15, or even 20, horse-power, although usual sizes and customary work absorb only from 1 to



3 or 5. Power and work are reduced, in many cases, by the use of tools having a capacity for the production of a number of effects without removal of the piece from its place in the machine. Thus the "turret-lathe" is made with a vertical cylindrical tool-holder, or "turret," in which a number of cutting-tools of various sizes and shapes can be set, and by revolution of the turret on its vertical axis each can be brought into play in due order to complete a series of operations, and sometimes to finish the piece. One tool and one workman thus perform a series of operations which otherwise would require as many tools and as many men, in sequence, thus saving enormously in cost of machinery, and of time as well.

R. H. THURSTON.

MACHROCHIRES. See HUMMING-BIRD, Vol. XII, p. 357.

MACIEJOWSKY. See POLAND, Vol. XIX, p. 303.

MCINTOSH, MARIA JANE, an American authoress; born at Sunbury, Georgia, in 1803. She moved to New York in 1835, and having suffered financial loss in the panic of 1837, turned her attention to literature. Her first work was *Blind Alice*, published in 1841, after which followed four other juvenile tales, the five being published collectively under the title *Aunt Kitty's Tales* in 1847. Among her other books are *Conquest and Self-Conquest* (1844); *Woman in America* (1850); *Meta Gray* (1858). She died Feb. 25, 1878.

MACK VON LEIBERICH, KARL, an Austrian soldier; born at Neuslingen, Franconia, Aug. 24, 1752; entered the military service of Austria in 1770, was created field-marshal in 1797. In 1798 he commanded the Neapolitans against the French, was taken prisoner and carried to Paris, but escaped by a violation of his parole. In 1805 the Emperor put him at the head of 80,000 men and sent him to check the French advance along the line of the Iller. But the enemy outmaneuvered him, and shut him up in Ulm, and on October 17th he capitulated with his army.

MACKAY, CHARLES, a Scotch poet, born in Perth, March 27, 1814. In 1834 he became assistant editor of the *Morning Chronicle*; from 1844 to 1847 was editor of the *Glasgow Argus*; was on the staff of the *Illustrated London News* for a long time, and filled the post of New York correspondent for the *London Times* during the Civil War. In 1860 he established the *London Review*, a weekly journal, which was discontinued. He is best known by his songs, two of which, *There's A Good Time Coming* and *Cheer, Boys, Cheer*, were especially popular. Among his works are *Songs and Poems* (1834); *History of London* (1837); *Longbeard*, a romance (1840); *Town Lyrics* (1848); *Lost Beauties of the English Language* (1874); *The Founders of the American Republic* (1885); and several works on the language and literature of ancient Scotland. He died in London, Dec. 24, 1889.

McKEAN, THOMAS, a signer of the Declaration of Independence, was born at Londonderry, Pennsylvania, March 19, 1734. In 1765 he was elected

to the Stamp Act Congress; from 1774 to 1783 was member of the Continental Congress. He was chief justice of Pennsylvania (1777-99), and from 1799 to 1808 governor of Pennsylvania. Although a resident of Pennsylvania, he was president of Delaware in 1777, and drafted the constitution of that state, it is said, in a single night and with no book of reference. He died in Philadelphia, June 24, 1817.

McKEESPORT, a borough of Allegheny County, southwestern Pennsylvania, 10 miles E.S.E. of Pittsburg, on the Monongahela River, at the mouth of the Youghiogheny, and on the Pennsylvania, the Baltimore and Ohio and the Pittsburg and Lake Erie railroads. It is the center of a great bituminous coal-mining region, and also of the natural-gas field of the state. The principal manufactures are of iron products; the largest wrought-iron pipe-works in the world are located here, and employ six thousand hands. Locomotive, car, glass and lumber factories, saw and rolling mills, foundries, machine-shops and a distillery are among its industrial establishments. Those which reported in 1890 had a combined capital of \$11,000,000, and produced merchandise, annually, to the value of \$16,000,000. It has a considerable river trade. It has numerous schools, an academy and three national banks. Population 1870, 2,523; 1880, 8,212; 1890, 20,741; 1900, 34,227.

McKEE'S ROCKS, a village of Allegheny County, southwestern Pennsylvania, five miles below Pittsburg, on the Ohio River, and on the Pittsburg, Chartiers and Youghiogheny railroad. It contains iron-bridge works, iron and steel mills, planing-mills, a glass factory, railroad machine-shops, and ships coal and lumber. It has natural-gas fuel. Population 1890, 1,687; 1900, 6,352.

McKENDREE, WILLIAM, an American clergyman, the first Methodist Episcopal bishop in the United States; born in Virginia, July 6, 1757. During the Revolutionary War he served as adjutant and commissary. At the close of the war he studied theology, became a preacher in 1788, presiding elder in 1796, and bishop in 1808. He was largely instrumental in planting Methodism west of the Alleghenies and in founding McKendree College at Lebanon, Illinois, to which institution he bequeathed 480 acres of land. He died near Nashville, Tennessee, March 5, 1835.

McKENDREE COLLEGE, a co-educational institution for higher learning, located in Lebanon, Illinois, maintained and controlled by the Methodist Episcopal church. It was organized in 1828, and in 1895 had 276 students, 13 instructors, and a library of 8,000 volumes. Including 1895, the college had graduated 580.

McKENNA, JOSEPH, American jurist and statesman; born in Philadelphia, Pa., Aug. 10, 1843; removed with his parents to the Pacific Coast in 1855; was educated at St. Augustine Institute at Benicia, California; studied law under Prof. Abbot, and was admitted to the bar in 1865. He served as county prosecuting attorney in 1865-69; and in 1875 was elected to the State legislature. After having been twice defeated for Con-

gress he was elected in 1884 and reelected for every term thereafter until appointed United States Circuit Judge in California in 1892 by President Harrison. Judge McKenna's profound knowledge of law and extensive experience, no less than his admirable personal qualities, recommended him for a Cabinet position, and his appointment in 1897 to the Attorney-Generalship gave universal satisfaction throughout the West.

MCKENZIE, a town of Carroll County, north-western Tennessee, 98 miles W. of Nashville, on the Louisville and Nashville and the Nashville, Chattanooga and St. Louis railroads. It is in a cotton, grain and live-stock raising region; has saw and grist mills and a cotton-gin. It is the seat of McTyeire Institute (Methodist, founded in 1882), and of Bethel College, a Cumberland Presbyterian co-educational school, opened in 1849, which in 1896 had 7 instructors, 200 students, and a library of 1,000 volumes. Population 1900, 1,266.

MACKENZIE, ALEXANDER, Canadian statesman; born at Logierait, near Dunkeld, Perthshire, Scotland, Jan. 28, 1822; educated at Perth and at Dunkeld. Having emigrated to Canada he edited the *Lambton Shield*, entered Parliament in 1861, and in 1867 was returned to the Dominion Parliament. He was also in the Ontario legislature in 1871-72. In 1873, on the defeat of the Macdonald ministry, he was called upon to form an administration in the Dominion Parliament. He was Premier and Minister of Public Works until 1878. He wrote *Life and Speeches of Hon. George Brown* (1882). Died at Toronto, April 17, 1892.

MACKENZIE, ALEXANDER CAMPBELL, a British musician, was born in Edinburgh, Aug. 22, 1847, and sent to Germany at the age of ten to study music, remaining till 1862 when he went to London to study the violin under M. Sainton. In 1865 he returned to Edinburgh as a teacher of the pianoforte. The composition which made him famous was his opera *Colomba*, based upon Mérimée's celebrated story. He was elected principal of the Royal Academy of Music in Feb. 1888, and in 1893 became conductor of the Philharmonic Society. Among his later compositions are the opera *The Troubadour* (1886); the cantatas, *The Bride* (1880) and *Jason* (1882); two Scotch rhapsodies; *Juilee Ode* (1887); *The Cottar's Saturday Night* (1890); and *Bethlehem* (1894).

MACKENZIE, ALEXANDER SLIDELL, an American naval officer; born in New York City, April 6, 1803. His original name was Slidell, he being the brother of the United States Senator of that name, but he adopted his uncle's name, Mackenzie, at the request of the latter, in 1837. He entered the navy in 1815 as midshipman; was made lieutenant in 1825; commander in 1841. In 1842 he was put in command of the brig *Somers*, manned by naval cadets, and on its passage from Africa discovered a plot among the crew to mutiny. After a council of officers had been called, he ordered the hanging of three of the conspirators, among whom was the son of John C. Spencer, the Secretary of War. The order was carried out, and upon the arrival of the brig in America a court of inquiry was instituted,

which, however, upheld Mackenzie's action. He also was acquitted by a court-martial held at his own request. The criticisms of his accusers, however, could not be silenced, and they embittered the remainder of his life. During the Mexican War he took part in the siege of Vera Cruz and the storming of Tabasco. Mackenzie devoted considerable time to authorship, and published, among other works, *A Year in Spain* (1829); *Popular Essays on Naval Subjects* (1833); *Life of John Paul Jones* (1841); and *Life of Decatur*, in Jared Sparks's Library of American Biography (1846). He died at Tarrytown, New York, Sept. 13, 1848.

MCKENZIE, MARIAN. See SMITH-WILLIAM, MRS., in these Supplements.

MACKENZIE, SIR MORELL, an English physician and specialist on throat diseases; born at Leytonstone, Essex, July 7, 1837, and educated at the London University, in Paris, and in Budapest, where he met Czermak, the Bohemian physiologist, who showed him the use of the laryngoscope, which Mackenzie later introduced in London. He returned to England, and in 1863 founded the Hospital for Diseases of the Throat, Golden Square; in the same year he obtained the Jacksonian prize from the Royal College of Sur-



SIR MORELL MACKENZIE.

geons for his essay on diseases of the larynx. He was soon afterward elected assistant physician to the London Hospital, becoming, in 1873, head physician, and was appointed lecturer on diseases of the throat, which position he held until his death. He was a corresponding member of the Imperial Royal Society of Physicians of Vienna, and of the Medical Society of Prague, and an honorary fellow of the American Laryngological Association. Dr. Mackenzie was the author of numerous publications on laryngological subjects; among them, a systematic treatise, in two volumes, on *Diseases of the Throat and Nose* (1880) and *The Hygiene of the Vocal Organs* (1886). He was knighted in 1887 by Queen Victoria for his services in prolonging the life of the late Emperor Frederick of Germany. Died in London, Feb. 3, 1892.

MACKENZIE RIVER, in North America, has its origin as the Athabasca, in the Rocky Mountains, in British Columbia, flows over 600 miles to Lake Athabasca, and 240 as the Slave River to Great Slave Lake, conveying the waters of the Great Slave Lake to the Arctic Ocean at Mackenzie Bay, after a final course which is reckoned at 1,045 miles, making a total river system of nearly 2,000 miles. It drains an area of little less than 600,000 square miles. The Mackenzie received its name from Sir Alexander Mackenzie, by whom it was discovered and first navigated in 1789. See also ATHABASCA, Vol. II, p. 827.

MACKEREL-GULL, a popular name of the

terns (*Sterna*), given because of their habit of hovering over schools of mackerel. Some authors think that the name refers to the forked tail, resembling that of the fish. The name is particularly applied to a New Zealand gull with habits similar to the jaeger-gull.

MACKEY, ALBERT GALLATIN, an American writer on Freemasonry; born at Charleston, South Carolina, March 12, 1807. In 1838 he became demonstrator of anatomy in the Medical College of South Carolina. In 1844 he gave himself up to the pursuit of literature. He founded, in 1849, and edited the *Southern and Western Masonic Miscellany*, and in 1858 to 1860 a *Masonic Quarterly*. Among his works, which are considered authoritative, are *Book of the Chapter* (1858); *A History of Freemasonry in South Carolina* (1861); *Masonic Parliamentary Law* (1875), and *The Encyclopedia of Freemasonry* (1874), his most important work. He died June 20, 1881.

MACKIE'S TYPE-SETTING MACHINE.  
See TYPE-COMPOSITION, in these Supplements.

MACKINAC, an island three miles long by two broad, in the Strait of Mackinac, which connects Lakes Huron and Michigan, three miles E. of Point St. Ignace. It forms a part of Mackinac County, Michigan. On the island is the village of Mackinac, and on an eminence 300 feet above is Fort Mackinac, now abandoned as a military post. This point was of considerable importance in colonial times; settled by the French, and was for a time a Jesuit missionary station; captured by Pontiac and its inhabitants massacred in 1669; captured by the British in 1812. The island has a good harbor, and is a popular summer resort. Fish are abundant. Population 1894, of island, 705; of village, 448.

MCKINLAY, MRS. JOHN (ANTOINETTE STERLING), an American contralto; born at Sterlingville, New York, Jan. 23, 1850. She studied music in America and afterward in Cologne under Mme. Marchesi, and in London under Manuel Garcia. She first intended to sing in opera, but abandoned the idea and returned to America in 1871, singing in the choir of Dr. Beecher's church in Brooklyn. On Nov. 5, 1873, she made her first appearance before a London audience at one of the Covent Garden concerts. Her success was immediate, and for the next twenty years she remained abroad, with the exception of a single visit to America, when she sang in concerts under Theodore Thomas. In 1875 she married John McKinlay. Her repertoire was largely of Scotch ballads and German *lieder*, the latter of which she was the first to sing before American audiences. In 1896 Mrs. McKinlay made a second visit to the United States. She possessed a contralto of great richness and volume, with a compass from E<sub>3</sub> in the bass to F in the treble stave.

MCKINLEY, WILLIAM, an American statesman; born at Niles, Ohio, Jan. 29, 1843. When he was nine years old his parents moved to Poland, in the same state, and he received his early education at the Poland Seminary. In 1860 he entered Allegheny College, Meadville, Pennsylvania, but was obliged to leave in the first year on account of ill health. For a while he taught school in Poland, and in June, 1861, he enlisted in the Twenty-third

Ohio Volunteers, commanded by Colonel (afterward General) Rosecrans, and served throughout the war, attaining the rank of captain, with the brevet of major. He resigned his commission in 1865, returned to Poland, began the study of law, and after a year in the Albany Law School, was admitted to the bar in 1867. He began the practice of law in Canton, Ohio, entered politics at once, and became one of the best stump speakers for the Republican party in the state. In 1869 he was chosen prosecuting-attorney for Stark County, Ohio. In 1876 he was elected to Congress, and re-elected for each successive term until 1882. In that year his election was contested, but he was allowed to retain his seat until late in the last session. He was returned to the House again in 1884, and continued to hold the office until the election of 1890, when he was defeated by the antagonism aroused by his tariff measure of the preceding session. From his first entrance into Congress, Mr. McKinley was a firm supporter of the doctrine of protective tariff, making it the leading tenet of his political activity. He was placed upon the Committee of Ways and Means in 1881, and, when made chairman of that committee in 1889, introduced the tariff measure since known as the McKinley Law, which passed the House May 21, 1890, and the Senate on the 30th of the following September. After his defeat in the next Congressional election, he was chosen governor of Ohio, November, 1891, by a majority of 21,000, after a campaign fought almost exclusively on the tariff issue. In 1893 he was re-elected governor of Ohio by a majority of 80,000. In June, 1896, Governor McKinley was nominated for the Presidency on the first ballot by the Republican national convention held in St. Louis. During the election campaign he daily addressed delegations visiting Canton with great candor and tact. When the election occurred in the following November Mr. McKinley carried twenty-three states and won a large majority in the electoral college as well as in the popular vote. In the Presidential elections, November, 1900, Mr. McKinley again carried the country for his party, his Administration receiving the hearty endorsement of the Nation. While attending the Pan-American Exposition at Buffalo, N. Y., Sept. 6, 1901, President McKinley was twice shot by Leon Czolgosz, a miscreant of Polish descent, who had imbibed anarchist doctrines. The hideous attempt on the life of the estimable president had its fatal issue early in the morning of Sept. 14th, and evoked world-wide grief and sympathy. On the 16th inst., the body was taken to Washington, where a funeral service was held at the Capitol, after which the remains were taken to the president's home at Canton, Ohio, and interred with every mark of a nation's esteem and affection on Thursday, Sept. 19th. The



WILLIAM MCKINLEY.

dastardly crime which deprived the country of its beloved chief executive, necessitated the succession of the vice-president, Theodore Roosevelt, to the presidency. The formal installation into office of President Roosevelt took place at Buffalo, on the afternoon of his predecessor's lamented death (Sept. 14, 1901).

McLACHLAN, ALEXANDER, a Scottish "weaver of rhymes," and known as the "Canadian Burns," was born in Johnstone, Renfrewshire, Scotland, in 1818. His family emigrated to Canada when the poet was but two years old, and settled on a farm in western Canada. Here the Canadian bard received his humble education and grew to manhood, nursing the poetic faculty and drawing inspiration for his backwoods muse from rural sights and sounds. Most of his poems belong peculiarly to Canadian life. Two features of the poet's character which reveal themselves in his verse are his religious seriousness, relieved by quiet touches of humor. He died at Orangeville, Ontario, March 20, 1896.

McLACHLAN, ROBERT, an English entomologist; born in London, April 10, 1837. He was educated at Ilford, in Essex, and early in life showed a taste for natural history, for botany at first, but later especial interest in the study of insects. In 1855-56 he went to China and Australia, and made a collection of plants from the latter place. In 1858 he was elected member of the Entomological Society of London, and was its president in 1885-86. He also was elected to the Linnæan and Royal societies. In 1864 the *Entomologist's Monthly Magazine* was founded, and Mr. McLachlan remained permanently on its staff. He is the author of *Revision and Synopsis of the Trichoptera (or Caddis-flies) of the European Fauna* (1880), the first work of its kind published, and an authority on that order. Mr. McLachlan wrote the article on INSECTS in this ENCYCLOPEDIA.

MACLAGAN, WILLIAM DALRYMPLE, archbishop of York and primate of England; born at Edinburgh in 1826. He served in the English army in India, and retired with the rank of lieutenant in 1852. He entered St. Peter's College, Cambridge, graduating B.A. (1856); M.A. (1860); was ordained deacon (1856); priest (1857); was curate in Paddington and Marylebone until 1860; secretary of the Church Building Society from 1860 to 1865; curate at Enfield from 1865 to 1869; became rector at Newington in 1869, and later vicar of St. Mary Abbots, Kensington; bishop of Lichfield in 1878; in 1891 archbishop of York. He edited, with Dr. Weir, *The Church and the Age* (1870); and published his *Pastoral Letters and Synodal Charges* (1891).

McLANE, LOUIS, an American statesman; born in Smyrna, Delaware, May 28, 1786. He entered the navy at 12 and for a year was midshipman under Decatur on the *Philadelphia*; left the navy in 1801, attended Newark College, Delaware, studied law and was admitted to the bar in 1807; was elected to Congress in 1817 and served until 1827. In 1827-29 he was United States Senator; from 1829 to 1831 minister to England, and then Secretary of the Treasury. In 1834 he retired from political life. In 1845-46 he was again minister to England. Died in Baltimore, Md., Oct. 7, 1857.

McLANE, ROBERT MILLIGAN, diplomatist, son of the preceding; born in Wilmington, Delaware, June 23, 1815. He was educated at St. Mary's College, Baltimore; at the Collège Bourbon, in Paris, and at West Point. He graduated at the latter place in 1837, entered the United States army and took an active part in the Seminole war. In 1839 he was sent on a military survey of the northern lakes and in 1841 went to Europe to examine the system of dykes and drainage in Holland and Italy. In 1843 he resigned his commission and began the practice of law at the Delaware bar, and in 1845, 1847 and 1849 was elected to Congress. From 1854 to 1856 he was United States commissioner to China, and in 1859 was appointed minister to Mexico. In 1877 he was elected to the Maryland senate, and in 1878 Representative to Congress, receiving a re-election in 1880. In 1883 he became governor of Maryland, and in 1885 minister to France, serving until 1889, when he resigned. Died in Paris, April 16, 1898.

MACLAREN, IAN. See WATSON, JOHN, in these Supplements.

McLAREN, WILLIAM EDWARD, an American bishop; born in Geneva, New York, Dec. 13, 1831, graduated at Washington and Jefferson College, Pennsylvania, in 1851, and at the Alleghany Presbyterian Theological Seminary in 1860. For three years he served as a missionary in South America. On his return he became pastor of the Second Presbyterian Church of Peoria, Illinois; in 1866 of the Westminster Church, Detroit, Michigan. Later he decided to enter the Protestant Episcopal ministry, was ordained in 1872, and became rector of Trinity Church, Cleveland, Ohio. In September, 1875, he was elected bishop of Illinois. When, two years later, two dioceses were set apart from his own, he retained that part of the state now included in the diocese of Chicago, over which he continued to preside. Bishop McLaren published *Catholic Dogma, the Antidote of Doubt* (1894).

McLAWS, LAFAYETTE, an American Confederate soldier; born in Augusta, Georgia, Jan. 15, 1821. He graduated at the United States Military Academy in 1842, and entered the United States army. He served in the Mexican War, in the expeditions against the Mormons in 1858, and against the Navajo Indians in 1859-60. In 1861 he resigned his commission and became a colonel in the Confederate army. A little later he was commissioned a brigadier-general, and in 1862 was promoted major-general. He participated in nearly all the important battles of the Civil War in the East, and on the conclusion of hostilities went into business at Savannah, Ga. Died there July 24, 1897.

McLEAN, JOHN, an American jurist; born in Morris County, New Jersey, March 11, 1785. He worked on a farm until 16 years of age, then went to Cincinnati, obtained a clerkship in the office of the county clerk, and studied law. He was admitted to the bar in 1807, and began practice in Lebanon, Ohio. In 1812 he was elected to Congress and re-elected in 1814; in 1816 was elected judge of the Ohio supreme court; in 1822 was appointed commissioner of the general land-office

In July, 1823, President Monroe made him Postmaster-General, and on account of his efficiency he was given the same position in John Quincy Adams's Cabinet. He refused the same portfolio in Jackson's administration, and also declined the departments of the War and the Navy, and was appointed by Jackson associate justice of the United States supreme court in 1830. In this position he became noted for his charges to grand juries. In 1838 he delivered the charge in regard to aiding or favoring "unlawful military combinations by our citizens against any foreign government with which we are at peace," which had reference to the aid given the Canadian rebels by American citizens. In the case of Dred Scott, Justice McLean dissented from the opinion of the court as given by Chief Justice Taney, maintaining that slavery had its origin in force, not right, and was contrary to the principles of general law, and only upheld by local law. In the Free-soil convention in 1848 and in the Republican conventions of 1856 and 1860 he was a candidate for Presidential nomination. He published *Reports of the United States Circuit Court* (1829-55); and a *Eulogy on James Monroe* (1831). He died in Cincinnati, Ohio, April 1, 1861.

MACLEAN, LETITIA ELIZABETH (Landon). See LONDON, Vol. XIV, p. 278.

MACLEANSBORO, a village and the capital of Hamilton County, southeastern Illinois, situated in the center of the county and 50 miles S.E. of Centralia, on the Louisville and Nashville railroad. It is the trade center of a prosperous farming, lumbering and stock-raising district. It has flour, woolen and saw mills. Population 1890, 1,355; 1900, 1,758.

MACMAHON, MARIE EDMÉ PATRICE MAURICE, COMTE DE, DUC DE MAGENTA, a marshal of France, and second President of the French Republic; born at Sully, Saône-et-Loire, June 13, 1808. He came from an Irish Catholic family settled in France at the time of James II's exile. He was educated at the Military School of St. Cyr, and took part in the expedition to Algiers. He distinguished himself in the assault on Constantine in 1837. In 1845 he rose to be colonel; in 1848 general of brigade, and in 1852 general of division.



MARSHAL MACMAHON.

During the Crimean War he captured, by a spirited assault, the Malakoff tower, which was the key to the defenses of Sebastopol, and held his position despite an order to retreat received from his superior officer, to whom he made the reply, "*J'y suis; J'y reste*" (I am here; I remain here), which has become historic. For this achievement he was made a Senator in 1856. He distinguished himself in the Italian campaign of 1859, commanding the Second Corps of the army of the Alps. At the battle of Magenta, on June 4th, he led the left and won

the day by his timely support of the Emperor, who commanded the center. For this service he was created Duke of Magenta and marshal of France.

In 1870, when the Franco-Prussian war broke out, MacMahon commanded the First Army Corps in the defense of Alsace. On Aug. 4, 1870, his advance guard, under Douay, was defeated at Weissenbourg by the Crown Prince of Prussia, and two days later the Marshal himself was defeated in the battle of Wörth (called by the French Reichshoffen) and his army routed. A retreat was made to Châlons and a new army formed, mostly of raw recruits, the command of which was given to MacMahon. He was ordered by the War Department at Paris to march to Metz and relieve Bazaine. MacMahon did not favor this plan, but, after repeated remonstrances, obeyed. His march was very slow, and at Sedan, on the Meuse, he met a German army of 180,000 men, his own force numbering 120,000. On September 1st the battle of Sedan was begun. Early in the day MacMahon was wounded, and the chief command fell upon General Ducrot. The result of the battle was a victory for the Germans, the Emperor and MacMahon being taken prisoners. This virtually decided the war. After the peace, in 1871, MacMahon assumed command of the army of Versailles and put down the insurrection of the Commune. On May 24, 1873, upon the overthrow of Thiers, he accepted the Presidency of the republic. Although monarchical at heart, he kept faithfully his oath to preserve the Republic, but the ministers he chose in the last year of his Presidency having tried to govern without a majority in the Chambers, the general elections that followed compelled the Marshal to resign, Jan. 30, 1879. After his resignation he lived in retirement on his estate at Montcresson until his death, Oct. 17, 1893.—His son, PATRICE MACMAHON, married Princesse, Marguerite d'Orléans, daughter of the Duc de Chartres, in April, 1896.

MCMASTER, JOHN BACH, an American historian; born in Brooklyn, New York, June 29, 1852; graduated at the College of the City of New York in 1872; in 1877 became instructor in civil-engineering at Princeton College, and in 1883 professor of American history in the University of Pennsylvania. He wrote a *History of the People of the United States from the Revolution to the Civil War*; a *Life of Benjamin Franklin*; and, with F. D. Stone, *Pennsylvania and the Federal Constitution*. He contributed the series of articles on the various political parties in the United States, and the article on the Monroe doctrine, in these Supplements.

MCMASTER UNIVERSITY, Toronto, Canada, an arts and theological training college in the interest of the Baptist denomination. Its chief promoter, after whom the institution is called, was Senator William McMaster, who contributed nearly a million dollars toward its endowment. The university received its legal incorporation in 1887, when it absorbed the separate institutions of Woodstock College and Toronto Baptist College. It is under the control of a board of governors and a senate, which are ultimately responsible to the Baptist Convention of Ontario and Quebec. The teaching

faculty in theology is required to be of the Baptist communion, but those in the arts course are required only to be of good standing in an evangelical Christian church. Of students, other than theological, of the university, no compulsory religious qualification is insisted upon.

MACMILLAN, ALEXANDER, an English publisher; born at Upper Carrie, island of Arran, Scotland, Oct. 3, 1818. His father was a farmer. Like his brothers, who all became clerks in bookshops or teachers. Alexander early showed a love for books. He was for a time teacher at Nitshill, near Paisley, and in 1839 entered the publishing house of L. and G. Seeley in London. Four years later he and his brother Daniel (who died in 1859) opened a bookstore in Aldersgate Street, and in the same year published their first book, Craig's *Philosophy of Training*. Soon, however, the business was removed to Cambridge and a partner taken into the firm, which became known as Macmillan, Barclay and Macmillan until the retirement of Mr. Barclay in 1850, when the name was changed to Macmillan and Company. In 1863 the headquarters of the firm were removed again to London. In the same year Alexander Macmillan was appointed publisher to the University of Oxford, a position which he retained until 1880, when the university established its own printing-office. In 1869 Macmillan visited America and established a branch office in New York city. Died in London, Jan. 25, 1896.

MACMILLAN, CONWAY, an American botanist; born in Hillsdale, Michigan, Aug. 26, 1867; educated in the University of Nebraska and at Johns Hopkins and Harvard; appointed assistant in geology at the University of Nebraska in 1886; entomologist at the agricultural experiment station in Nebraska in the following year; in 1888 instructor in botany in the University of Minnesota; professor of botany in 1891. He published *Twenty-two Common Insects of Nebraska* (1888) and *The Metaspermæ of the Minnesota Valley* (1892).

MACMILLAN, HUGH, a Scotch minister and author; born at Aberfeldy, Perthshire, Sept. 17, 1833. He was educated in Edinburgh University, and held pastorates at Kirkmichael (1859-64); in Glasgow, of Free St. Peter's (1864-78); and later, of the Free West Church at Greenock. Among his works, some of which have been translated into several languages, are *First Forms of Vegetation* (1861); *Bible Teachings in Nature* (1867); *Holidays on High Lands* (1873); *The True Vine* (1884); *The Olive Leaf* (1886); and *Roman Mosaics* (1888).

McMILLAN, SAMUEL J. R., an American statesman and jurist; born in Brownsville, Pennsylvania, Feb. 22, 1826; died in St. Paul, Minnesota, Oct. 3, 1897. In 1874 he was chosen Chief Justice of the Minnesota Supreme Court, and was elected to the United States Senate after a noted and prolonged contest. On his re-election in 1881 he succeeded Roscoe Conkling as chairman of the commerce committee. He was a prominent member of the Presbyterian Church, and in 1890 was appointed one of a committee to revise the Confession of Faith of that denomination.

MACMINNVILLE, a town and the capital of Warren County, central Tennessee, 65 miles S.E. of Nashville, on the Nashville, Chattanooga and St. Louis railroad. It contains woolen and cotton mills, a spoke and handle factory, an iron foundry and the MacMinville Female Academy. Population 1890, 1,677; 1900, 1,980.

MACMONNIES, FREDERICK, an American sculptor; born in Brooklyn, New York, Sept. 28, 1863; began his studies in sculpture in the studio of Augustus St. Gaudens in 1880, working at night, meanwhile, in the Academy of Design and the Art Students' League. In 1884, he went to Paris, where he studied with Falguière and Antonin Mercié, the sculptor of the *Vae Victis*. While abroad he sent a *Diana* to the Salon of 1889, which brought him an honorable mention. He also exhibited three life-sized angels, which were destined for St. Paul's Church, in New York City, and a statue of Nathan Hale, which is in City Hall Park, in the same city. To the Salon of 1891 he sent a statue of James S. T. Stranahan, where it received a second medal, the first and only time an American sculptor has been honored in that manner by the Salon judges. The statue has since been placed in Prospect Park, Brooklyn. Some of his ideal works have been *Pan of Rohalion* and *Faun with Heron*, followed by his fine colossal *Fountain at the World's Columbian Exhibition*. His *Sir Harry Vane*, for the Boston Public Library, and *Victory*, for the Battle Monument at West Point, are other works displaying decided genius. His *Shakespeare*, for the Congressional Library at Washington, is full of a scholarly feeling. In 1894 he finished, for the Boston Public Library, a *Bacchante with Infant Faun*, which represents the Bacchante dancing forward in a spirited manner, holding a bunch of grapes in her right hand, thrown aloft, while sitting on her left arm is the infant faun, apparently about to spring forward to grasp the grapes, upon which his eyes are set longingly. The figures were entirely nude, and are modeled with exquisite grace and freedom. When this group was shown in Paris it created so much enthusiasm that the French government offered to purchase it, but as it was a commission from the Boston Public Library, a replica finally was accepted in lieu of purchase. Notwithstanding its artistic excellence, however, the work was rejected by the Boston judges, and was secured by Brooklyn, N. Y. In 1898 he finished a group typifying *War*, for the Memorial Arch, Brooklyn, N. Y.

McMURROUGH. See IRELAND, Vol. XIII, p. 258.

MCNAB, ALAN NAPIER, a Canadian soldier and statesman; born at Newark (now Niagara), Canada, Feb. 19, 1798. At the outbreak of the War of 1812 he entered the Canadian army and was transferred to the navy, but afterward returned to the army and took part in the capture of Fort Niagara and in the battle of Plattsburg; resigned his commission at the end of the war, began the study of law, and was admitted to the bar in 1826; began practice in Hamilton; was elected to the Upper Canadian assembly in 1830; speaker (1837-41); in the Upper Canadian rebellion of 1837-38 was put at the head

of a band of volunteers, with the rank of colonel, and routed the rebels on the Niagara frontier; became Parliamentary leader of the Conservative party after the union of Upper and Lower Canada; in 1856 retired from political life and was made baronet; visited England in 1857, and was made honorary colonel and aide-de-camp to the Queen; returned to Canada in 1860, and was re-elected to Parliament. He died in Toronto, Aug. 8, 1862.

M c N A L L Y, A N D R E W, an American publisher; born in the north of Ireland, in 1836, of Scotch descent; was apprenticed to John McWatters, a printer of Armagh, Ireland, for whom he worked for seven years, acquiring in that time an intimate knowledge of the detail of the printing and publishing business; removed to America in 1858, and in 1860 started a printing-office in Chicago, but soon after sold it and took charge of the *Tribune* job-office; in 1864 became associated with W. H. Rand in the formation of the Rand-McNally Company. The first noteworthy publication of the firm was the *Rand-McNally Railway Guide*, which appeared in 1869; since then they have been engaged in railroad-printing, map-engraving, and general publishing of all kinds. Mr. McNally was a director of the World's Columbian Exposition, a vice-president of the Chicago National Bank, and president of the stock company which owned the *Prairie Farmer*, an agricultural paper having a large circulation in the West.

M A C O M B, a city and the capital of McDonough County, central western Illinois, 185 miles S.W. of Chicago, on the Chicago, Burlington and Quincy railroad. It is in an agricultural and fire-clay region, and produces pottery, tile, sewer-pipe, etc. It contains a foundry, a public library, excellent schools, and is the seat of McDonough Normal College. Population 1890, 4,052; 1900, 5,375.

M A C O M B, A L E X A N D E R, an American soldier; born in Detroit, Michigan, April 13, 1782; died in Washington, June 25, 1841. He entered the army, and at the beginning of the War of 1812 held the commission of lieutenant-colonel of engineers, and in 1813 served as colonel at Niagara and Fort George; was promoted brigadier-general of volunteers in 1814, on September 11th of which year he repulsed a superior force under General Prevost at Plattsburg, on Lake Champlain, and was made major-general for his conduct. After the war he remained in the army as colonel of engineers, and in 1828 became major-general and commander-in-chief of the army. During the Florida war in 1835 he was in the field for a short time. He published *A Treatise on Martial Law* (1809) and *A Treatise on the Practice of Court-Martials* (1840). *A Memoir of Alexander Macomb* was written by G. H. Richards (1833).—His son, WILLIAM HENRY M A C O M B, born in Detroit, June 16, 1818, entered the navy in 1834, became commander in 1862, captain in 1866, and commodore in 1870. He was distinguished for courage and good judgment. He died in Philadelphia, Aug. 12, 1872.

M A C O N, a city of central Georgia. Nine railroads meet here and give excellent connections in all directions. The main lines are the

Southern and the Georgia Southern and Florida railroads. The average annual product of Macon's factories is valued at \$5,000,000; the aggregate capital, \$3,600,000. Number of employees, 3,142. The city's wholesale trade is estimated at \$50,000,000 annually. Its educational and charitable institutions include 45 public schools, a public library, the Alexander Free School, the Jones Home for Indigent Women, two orphans' homes, the State Academy for the Blind, and an academy of music. The city is supplied with spring water from a reservoir on a hill near by. It holds a large fair annually. Population 1890, 22,746; 1900, 23,272. See also M A C O N, Vol. XV, p. 166.

M A C O N, a town and the capital of Noxubee County, central eastern Mississippi, 198 miles N. of Mobile, on the Oakanoxubee Creek. The Mobile and Ohio railroad passes through the town and has its shops located here. It is the shipping-point of a large agricultural and cotton-growing region. Pop. 1890, 1,565; 1900, 2,057.

M A C O N, a city and the capital of Macon County, northeastern Missouri, 140 miles N.W. of St. Louis, on the Hannibal and St. Joseph and the Wabash railroads. It has manufactories of farming-implements and wagons, and an extensive foundry and machine-shop. It is in a stock-raising and fruit-growing district. Coal and timber are abundant. It contains St. Agnes Hall for girls and St. James Military Academy, both Protestant Episcopal schools. Population 1890, 3,371; 1900, 4,068.

M A C O Y A. See M A C A H U B A P A L M, in these Supplements.

M c P H E R S O N, a city and the capital of McPherson County, central Kansas, 36 miles S. of Salina, on the Atchison, Topeka and Santa Fé, the Chicago, Rock Island and Pacific, the Missouri Pacific and the Union Pacific railroads. It has flour-mills, and the chief industries of the region are sheep-raising, dairying and agriculture, especially corn and wheat raising. Of this region McPherson is the trading and shipping center. It is supplied with electric lights, city water and a street-railway. McPherson (Dunkard) College is located here. Population 1890, 3,172; 1900, 2,996.

M c P H E R S O N, E D W A R D, an American journalist; born in Gettysburg, Pennsylvania, July 31, 1830; graduated at the University of Pennsylvania in 1848, and studied law, but abandoned its practice for journalism. In 1858 and 1860 he was elected to Congress; was clerk in the House of Representatives (1863-73, 1881-83, and 1889-91). From 1877 to 1880 he was editor-in-chief of the *Philadelphia Press*; and in 1880 became editor of a paper in Gettysburg, Pennsylvania. From 1877 till his death he edited the *New York Tribune Almanac*; was the American editor of the *Almanach de Gotha*; published every second year *Handbook of Politics*; and was the author of *Political History of the United States During the Great Rebellion* (1865) and *Political History of the United States During the Period of*

*Reconstruction* (1871). He died in Gettysburg, Dec. 14, 1895.

MCPHERSON, JAMES BIRDSEY, an American soldier; born Nov. 14, 1828, in Sandusky County, Ohio. He graduated at the head of his class, July 1, 1853, and was employed as instructor at the Military Academy; served afterward in the engineer corps in New York harbor and at Fort Delaware. When the Civil War broke out he was stationed in California, but at his own request was transferred to the active service and placed on the staff of



GENERAL MCPHERSON.

General Halleck, with the rank of lieutenant-colonel. He took part in the expeditions against Forts Henry and Donelson, in the battle of Shiloh and in the operations around Corinth. In May, 1862, he was made brigadier-general of volunteers; in September placed on the staff of General Grant; in October made major-general. He remained with Grant during the Vicksburg campaign, and upon the recommendation of the latter was given the commission of brigadier-general in the United States army. After Sherman took command of the Western armies, McPherson became commander of the army of the Tennessee and accompanied Sherman on his Atlanta campaign. In the battle before Atlanta he was shot, and died almost instantly, July 22, 1864, while personally superintending the disposition of his troops.

MCPHERSON, JOHN RODERIC, an American public man; born in York, N. Y., May 9, 1833; was educated at Geneseo academy, and engaged in farming and stock-raising; removed to New Jersey in 1858, and settled at Hudson, where he established a stock-yard; was a member of the state senate of New Jersey in 1871-74; elected to the United States Senate in 1877; reelected in 1883 and again in 1889. Died in Jersey City, N. J., Oct. 8, 1897.

MACQUOID, MRS. KATHERINE S., an English authoress; born in Kentish Town, London, 1835. She wrote numerous works, mostly novels, some of which have been very popular; among them, *A Bad Beginning*, her first work, published anonymously in 1862; *Patty* (1871); *My Story* (1874); *Through Normandy* and *Through Brittany*, travels illustrated by her husband, Thomas R. Macquoid (1877); *Little Fifine*, and *Other Tales* (1881); *At the Red Glove* (1885); *Appledore Farm* (1895); and *The Story of Lois* (1898).

MACRINUS, M. OPELIUS. See HELIOGABALUS, Vol. XI, p. 632.

MACROPODIDÆ. See KANGAROO, Vol. XIII, pp. 838-841.

MACROSPORANGIUM, a botanical term applied to the spore-case which develops macrospores. The term is used only in cases of hetero-

ospory (q.v., in these Supplements), and distinguishes the sporangium containing macrospores from that one (microsporangium) which contains microspores. As heterospory occurs only in certain fern-plants and in the seed-plants, the term macrosporangium is similarly restricted. In seed-plants the macrosporangium is the ovule, which usually matures but a single macrospore (the "embryo-sac").

MACROSPORE, a botanical term used in heterosporous plants to designate the spore which produces the female gametophyte, as opposed to the microspore, which produces the male gametophyte. See REPRODUCTION, Vol. XX, p. 424, and in these Supplements.

MACRURIDÆ. See ICHTHVOLOGY, Vol. XII, p. 692.

MCTYEIRE, HOLLAND NIMMONS, an American bishop of the Methodist Episcopal Church South, born in Barnwell County, South Carolina, July 25, 1824; was educated at Randolph-Macon College and joined the Virginia Conference in 1845; held pastorates in Mobile, Alabama, Columbus, Mississippi, New Orleans, Louisiana, and Montgomery, Alabama. In 1854 he became editor of the New Orleans *Christian Advocate*, in 1858 of the Nashville *Christian Advocate*, and in 1866 was elected to the episcopate. In 1873 he became president of the board of Vanderbilt University. He is the author of *Manual of Discipline* and *A History of Methodism*. He died at Nashville, Feb. 15, 1889.

MCVEAGH, WAYNE, an American lawyer; born in Phoenixville, Pa., April 19, 1833; educated at Yale, and admitted to the bar in 1856; captain of cavalry, 1862, at the time of the threatened invasion of Pennsylvania; Minister to Constantinople, 1872; member of the commission known as the "McVeagh Commission," appointed to investigate the affairs of Louisiana in 1877; Attorney-General of the United States in 1881, resigning the same year; Ambassador to Italy in 1893.

MACWHIRTER, JOHN, a Scotch painter, born in 1839, near Edinburgh, Scotland. He studied under R. S. Lauder, and opened a studio in Edinburgh; was elected an associate of the Royal Scottish Academy in 1863. In 1869 he went to London, and was elected an associate of the Royal Academy in 1879. He was elected an honorary member of the Royal Scottish Academy in 1882; elected member of the Royal Institute of Painters in Water Colors the same year, and in 1893 member of the Royal Academy. Among his paintings, which are largely Scotch landscapes, are *The Windings of the Forth* (1884); *Edinburgh from Salisbury Craig* (1887); and *Nature's Archway* (1894).

MADAGASCAR. The area of the island is estimated at 227,750 square miles; total length, 975 miles; breadth at widest point, 358 miles. Population, about 3,500,000.

By a treaty signed at Tamatave, Dec. 12, 1885, a French resident-general, with a small military escort, lived at the capital, Antananarivo, a well-built town of 100,000 population, 200 miles in-



land, and controlled foreign relations. By the Anglo-French agreement of Aug. 5, 1890, Great Britain recognized the French protectorate, but the Malagasy, or Hovas Government, refused to recognize any foreign interference, and in May, 1895, after two years of continual trouble between the French officers and the natives, a military expedition was dispatched to enforce the claims of France, the capital was occupied Oct. 1, and a treaty was signed whereby the Queen Rànavàlona III accepted the protectorate. All foreign relations and internal administration were put in the hands of a French resident-general, the Queen nominally retaining her office. On Jan. 18, 1896, the island was formally annexed to France.

The principal exports (average value about \$500,000 per annum) are cattle, hides, gum-copal, india-rubber, and rice, and more recently ebony and other valuable woods; coffee, sugar and vanilla are also being cultivated by Creole settlers. The chief imports (averaging about \$800,000 in value per annum) are cotton-goods, ironmongery, crockery and rum. The principal trade is from the Eastern ports to Mauritius, Réunion, Great Britain, France and the United States. The fertile soil of the coast plains can supply large quantities of all tropical productions. Iron is abundant, especially as magnetite, and also as hæmatite and ironstone, and the Malagasy are skillful in the smelting and working of this as well as other metals. Copper apparently exists in certain districts, and also tin is said to be found. Galena is found abundantly near Mount Ankaratra. Gold of excellent quality has recently been found in many parts of the interior, and is being worked by foreign capitalists as well as by the native government. Sulphur occurs in beds near some of the extinct volcanoes. There are few roads or wheeled vehicles in Madagascar, although there is no lack of manual skill among the people, who excel in weaving, in straw-work and in carpentry, as well as in the working of gold and silver.

Very recently, younger and more enlightened governors and other officers have been placed at all the principal ports and chief towns of the interior. Three-fourths of Madagascar is still heathen, but European and native missionaries are every year advancing steadily into the unenlightened regions, and Christianity is recognized and supported by the native government, although there is no state church. Queen Rànavàlona III, born in 1861, succeeded in 1883. See also MADAGASCAR, Vol. XV, pp. 168-176.

MADDER, a red dye, formerly much in use, but replaced now by the aniline dyes, and obtained from the roots and root-stalks of *Rubia tinctorum*, a plant of southern Europe and the Orient, belonging to the family *Rubiaceæ*. The name madder is also used as the common name of the genus *Rubia*, and the family *Rubiaceæ* is styled the Madder family.

MADDERN, MINNIE. See FISKE, M. M., in these Supplements.

MADEIRA, a river of Brazil, the most important affluent of the Amazon. It is formed by

the union of the Guaporé and Mamoré rivers near lat. 12° 5' S., long. 64° 30' W., on the Bolivian frontier. It flows generally northeast, and after a course of 935 miles joins the Amazon at long. 58° 45' W., 100 miles below Mamnaos. The Mamoré may be considered its chief head-water. This rises in the Bolivian Andes, in the department of Cochabama, and flows northward to its junction with the Guaporé. The Madeira, soon after this junction, is increased by the great Beni river. It then flows through a long series of rapids, about two hundred and thirty miles in extent, which render navigation impossible. The fall of the river is 270 feet. The lowest of these cataracts is the São Antonio Falls, 715 miles above its mouth. During the period of high water, from November to July, ocean steamers can ascend to this point, river-boats during the entire year. The valley of the Madeira and its tributaries is good agricultural country, but is neglected. A few wild Indians live there, and rubber-gatherers have settlements near its banks, as this is one of the most productive rubber regions in the world. The banks are low, and subject to annual inundations. The climate of these regions is malarious. A railroad around the falls has long been projected, but very little has been done toward its construction. This river drains an area of 480,000 square miles; its total length, to the head of the Mamoré, is 3,100 miles; average width, 2,700 feet, though it often exceeds a mile. The average discharge of water at its mouth is 517,000 cubic feet per second; maximum, 1,381,000 cubic feet per second. See also BOLIVIA, Vol. IV, pp. 11, 12.

MADEIRA NUT, a name sometimes given to the well-known English walnut, the fruit of *Juglans regia*.

MADELIA, a village and the capital of Watonwan County, central-southern Minnesota, 23 miles W.S.W. of Mankato, on the Chicago, St. Paul, Minneapolis and Omaha railroad, and on the Watonwan River; the trade and shipping-center of a farming district. Population 1890, 852; 1900, 1,272.

MADERNA, STEFANO. See SCULPTURE, Vol. XXI, p. 570.

MADISON, a city and the capital of Morgan County, northern-central Georgia, 55 miles E.S.E. of Atlanta, on the Georgia and the Macon and Northern railroads. The cotton trade is the chief business, and granite and iron-ore are found here. It has steam cotton-gins, steam saw-mills and a cotton compress. Situated here is Madison Male and Female Institute. Population 1890, 2,131; 1900, 1,992.

MADISON, a city of southeastern Indiana. It has manufactories of steamboats, engines, boilers, furniture and cotton and woolen goods. Population 1900, 7,835. See Vol. XV, p. 181.

MADISON, a village, and the capital of Madison County, northeastern Nebraska, 90 miles W.N.W. of Omaha, on a branch of the Elkhorn River, and on the Union Pacific railroad. It has an extensive creamery and flour-mills, and ships

large quantities of fruit, cattle and hogs raised in the vicinity. It is the seat of the North Nebraska Normal College. Population 1900, 1,479.

MADISON, a borough of Morris County, northern New Jersey,  $4\frac{1}{2}$  miles S.E. of Morristown, on the Delaware, Lackawanna and Western railroad. The principal industry is the growing of roses for the New York flower market. It is a residence locality for many New York business men. Situated here is the Drew Theological Seminary, a Methodist Episcopal institution, founded in 1866. It had in 1896, 7 instructors, 142 students and a library of 3,300 volumes. Population 1890, 2,469; 1900, 3,754.

MADISON, a city, and the capital of Lake County, central-eastern South Dakota, 38 miles W.N.W. of Sioux Falls, on the Chicago, Milwaukee and St. Paul railroad. It is in a farming and stock-raising region, where blooded horses are raised. It is the seat of a state normal school. Population 1890, 1,736; 1900, 2,550.

MADISON, a city of Wisconsin. This has lately become quite a popular summer resort on account of its picturesque environment. On the lake beach are fine summer hotels, and on Lake Monona meets the Monona Assembly, modeled after the Chautauqua Assembly. The city is supplied with city water, gas, electric lights and electric street-railways. It is the seat of Wisconsin University (q. v.). Population 1890, 13,426; 1900, 19,164. See MADISON, Vol. XV, pp. 181, 182.

MADISON, JAMES, an American bishop and educator, cousin of the President of that name; born in Augusta County, Virginia, Aug. 27, 1749. He graduated at William and Mary College in 1772, and studied law, but abandoned it for the study of theology; was made professor at William and Mary College in 1773; two years later was ordained priest of the Episcopal church in London; returned, and continued his work at the college, and became its president in 1777, an office which he held till his death. He was president of the first Episcopal convention in Virginia in 1785, and in 1790 was made first bishop of Virginia. Bishop Madison published *Eulogy on Washington* and a large map of Virginia. He died in Williamsburg, Virginia, March 5, 1812.

MADISON BARRACKS (Department of the East), a United States military post located at Sackett's Harbor (q. v. in these Supplements). It is garrisoned by a regiment of infantry.

MADISONVILLE, a town and the capital of Hopkins County, central western Kentucky, 35 miles south of Henderson, on the Louisville and Nashville railroad. It is situated in a tobacco-growing region, and contains tobacco-stemmeries, a pearlsh and potash factory, flour and planing mills, a cotton-gin and wagon and carriage manufactories. Coal-fields are in the vicinity. Population 1890 2,212; 1900, 3,628.

MADISONVILLE, a village of Hamilton County, southwestern Ohio, eight miles N.E. of Cincinnati, on the Baltimore and Ohio, Southwestern, and the Pittsburg, Cincinnati, Chicago and St.

Louis railroads. It has some trade with the surrounding vicinity, and has lumber and carriage factories and a tannery. Population 1900, 3,140.

MÄDLER, JOHANN HEINRICH, a German astronomer; born in Berlin, May 29, 1794. While a teacher in the normal school at Berlin, in company with Wilhelm Beer he constructed the finest map of the moon yet made, published in 1836. After this he became successively director of the observatory at Berlin and at Dorpat, Russia. He published *Populäre Astronomie* (1841); *Allgemeine Selenographie*; and *Geschichte der Himmelskunde* (1873). In his work *Die Zentralsonne* he presented the hypothesis of a central sun, around which the whole stellar universe revolves. He named the star Alcyone as the central sun. He died in Hanover, March 14, 1874.

MAETERLINCK, MAURICE or MOORIS, a Belgian playwright; born in Ghent in 1864. His works, which consist of dramas and poems, are weird and unhealthy, and resemble to a certain extent the writings of Verlaine and the French décadents. In 1895 *Pelléas et Mélisande* and the *Intruder* (*L'Intruse*) were produced in London under the poet's own supervision. Among his other dramas are *Les Aveugles*; *La Princesse Maleine*; *La Quenouille et la Besace*; *Les Sept Princesses* (1891); and *Aglavaine et Selysette* (1897). He has also written a volume of poems, *Serres Chaudes*; an introduction to a French translation of Emerson's *Essays*; *Ruysbroeck and the Mystics* (1894); *The Treasure of the Humble* (essays, 1897); and *Wisdom and Destiny* (essays, 1898). Several of his plays were translated into English by Richard Hovey (1895).

MAFEKING, a station in the northeastern corner of British Bechuanaland, South Africa, on the Transvaal border. Here and at Pitsani Pitlogo, in Dec., 1895, Dr. L. S. Jameson (q. v., ante, p. 1731) collected the troopers for his raid to Johannesburg, 150 miles to the eastward. A railroad to Mafeking from Cape Town extends northward to Bulawayo. The little town, which is situate on a flat plain on the banks of the Molopopo River, just inside Bechuanaland, eight miles from the Transvaal frontier, withstood a lengthened siege during the Boer war of 1899-1900. The siege began Oct. 16, 1899, six days after Mr. Kruger's government issued its ultimatum. Mafeking, though a bustling business centre, has no pretensions in the way of a city, the houses, for the most part, being built merely of corrugated iron and mud; and when war broke out it had absolutely no defences. Fortunately, the forethought of Lord Edward Cecil, a young officer, son of Lord Salisbury, had provided a quantity of stores in the place, and to this youth, and to the pluck, energy, and resource of Colonel (now Major-General) Robert S. S. Baden-Powell, the town was enabled to maintain a stirring defence for the period of seven months. The defending force at the outset consisted of 450 irregular cavalry, 250 Cape mounted police, 200 of the British South African Company's mounted police, about 100 local volunteers, with two 7-pounders and six machine guns. With this force, cheered by the undaunted courage

and animated by the patriotic spirit and tireless energy of Colonel Baden-Powell, the town withstood not only a protracted siege, but the repeated sorties and constant bombardment of a large body of enviroing Boers, together with the inroads of disease and the increasing menace of starvation. Repeated efforts were made, chiefly by Colonel Plumer, operating in the Buluwayo district, to relieve the gallant garrison, but without success until a junction was effected, in the middle of May, 1900, between Plumer's troops and the flying column, advancing from Vryburg and the south, under the command of Colonel B. T. Mahon. This latter column started on May 4 from Barkly West, 20 miles N. W. of Kimberley, and marching 200 miles in 12 days reached Janmassibi, 20 miles west of Mafeking, on May 15, there forming a junction with Colonel Plumer's column from the north. The combined force now moved upon Mafeking under Colonel Mahon. On May 17 it reached and attacked the beleaguering Boers, and aided by a brilliant sally on the part of Colonel Baden-Powell, the burghers were forced to raise the siege and withdraw from the long invested town. Mafeking was entered at 4 a. m. on the morning of May 18, to the relief of the emaciated garrison, and with the cheers of the troops and populace. Thus ended a long and spirited siege, and a defence as heroic and romantic as any that has occurred in the annals of modern war.

MAFIA OR MAFFIA, a secret Italian organization, formed in Sicily over six hundred years ago, and having for its present object the enforcement of private vengeance, or the substitution of its own authority for that of the law. In southern Italy, and especially in Sicily, its membership is made up largely of murderers and assassins. Its ramifications extended into some cities and towns of the United States; and in New Orleans, where a large Italian population has gathered during several years past, the murderous work of the Mafia in 1888, 1889 and 1890 was increasing constantly, and in June, 1890, culminated in a desperate fight between two factions on the streets of New Orleans. This determined the municipal authorities to break up the organization. In order to prevent this, it is alleged that the Mafia, in October of that year, murdered Hennessy, chief of police. Arrests were made, but a jury failed to convict. In March, 1891, six of the arrested men had escaped conviction, and ten were in jail with the prospect also of a similar verdict. The people of New Orleans believed the men to be guilty, and a mob broke into the jail and shot 11 of the prisoners, including those who had been acquitted. The incident led to a controversy between the Italian government and the United States, and to the temporary withdrawal of the Italian minister; but an amicable agreement was reached, by the terms of which the United States indemnified the relatives of the victims.

MAGALLANES, a territory of southern Chile, extending from lat. 47° S. southward to Cape Horn. It is very mountainous, and the coasts are broken by thousands of deep inlets. The land is good for

very little, but pasturage is found in places. The area of the territory is 75,292 square miles. Population 1894, 3,624; 1895, 5,170. Capital, Punta Arenas, on the Straits of Magellan. Both coal and gold are found in its vicinity. Population of the capital, Punta Arenas, by the census of 1895, was 3,227.

MAGAZINE GUNS. See GUNMAKING, Vol. XI, pp. 284, 285; and GUNNERY, in these Supplements.

MAGAZINE RIFLES. See GUNMAKING, in these Supplements.

MAGAZINES, AMERICAN. The reading public of America more than that of any other country derives its intellectual sustenance from the newspaper and magazine, and the development of the American periodical press has excelled that of any other country, with the possible exception of England. According to the latest edition of *Rowell's Newspaper Directory*, in 1883 there were 1,034 American monthlies, 12 bi-monthlies and 59 quarterlies. In 1896 there were 2,723 monthlies, 58 bi-monthlies, and 162 quarterlies. And this extraordinary increase in the number of periodicals is even more than equalled in the growth of the editions issued. But this astonishing development of American periodical literature, gratifying as it is in the light of progress and practical achievement, is not yet altogether satisfactory in its general results, for it is not possible to escape the fact that, admirable as are some of the established American magazines, the more recent ones owe their success not so much to serious literary effort as to the facile skill of the artists and illustrators. With the introduction of the various processes of photo and metal engraving—the sharp outlines of the zinc etching and the softer effects of the half-tone—the pictorial art, to a great degree, has crowded out the literary charm. On the other hand, and by way at least of a partial compensation, it is the popular periodical, aided by the cheap processes of engraving, that has furnished to the artist his surest means of reaching the public, with the result that in America illustrative work has attracted to it a very high order of talent.

A general survey of the American magazines during the last 15 years does not disclose any marked change in the relative position, as regards literary excellence, of the older publications. While it still remains true that America is lacking in any review comparable with the great English monthlies, a standard not greatly inferior is maintained by a few of them. The *Forum*, established in 1886, is a dignified publication; and were its articles more exhaustive and its political subjects less predominant, it would rank well as a general review. The *Classical Review* and *The Arena*, both of which were established in 1889, also belong to the better class of reviews, though the last-named is given to extravagance as a journal of reform. Between the review proper and the magazine, *The Atlantic Monthly*, one of the older publications, established in 1857, stands more distinctly for culture than any other American periodical. It has refused persistently to submit to dictates of public opinion, and has shaped its own course intelligently, without losing sight of its high ideal. The foremost illustrated magazines, *Harper's New Monthly* (1849), *Scribner's* (1887), and the *Century Magazine* (1870), are

admirable productions. In point of illustration they have no superiors anywhere, but much of their text appears to exist for the sake of the pictures, which is unfortunate from the literary standpoint. If what has just been said applies to the older and more important of the American illustrated monthlies, how much more does it characterize the later ones, whose large constituency almost forces their contents into the world of mediocrity!

One of the most remarkable features of the growth of periodical literature in America is the introduction of the popular low-priced magazines. Until the illustrated *Cosmopolitan* appeared, in 1885, the minimum price of the monthly magazine was twenty-five cents, the foremost periodicals of the older class, as *Harper's Monthly* and the *Century Magazine*, being thirty-five cents, which price they still maintain. The *Cosmopolitan*, under the management of J. Brisben Walker, came out as a fifteen-cent publication, and later reduced its price to ten cents. The result was to create an enormous demand for the magazine; and this success, from a commercial view at least, caused *Munsey's Magazine* (established in 1886), to reduce its price also, and with almost equally successful results so far as circulation is concerned. In 1893 *McClure's Magazine* appeared, based upon the same lines as the two earlier ten-cent monthlies already referred to. In all of these cheap magazines the illustrations are admirable, often artistic. But so far as the literary contents are concerned, the result is a sort of *bric-à-brac* collection, diverting enough, but too often lacking in the virile elements of culture and the higher lines of intellectual effort.

The magazines already referred to are produced in the East. In the *Overland Monthly*, established in San Francisco in 1861, the far West has an admirable literary representative. Its first editor was Bret Harte, and many of that writer's successful productions appeared first in its pages.

While the Eastern magazines have widened their horizon so as to take cognizance of the whole country, there is still a place for publications largely devoted to sectional interests. Such a place is filled in the East by the admirable *New England Magazine*, which was established in Boston in 1889. A new American periodical of some pretensions appeared in Chicago in August, 1896. It is the *International Magazine*, and aims largely to present English translations of a good class of literature from the French and German.

Another remarkable feature in the recent growth of periodical literature in America is the springing up of a large number of miniature magazines devoted to light reading of sensational character. Of these are *Short Stories* (1890), the *Black Cat* (1895), and *The Autocrat* (1896), the last-named appearing in Atlanta, Ga. Aside from the suggestive titles and sensational contents, the small price (five cents) of these periodicals in some instances has enabled them to secure a considerable circulation.

It is pleasant to turn again from the class of ephemeral literature to another and more elevating kind, which is but little short of the supremacy of literary art. With regard to its reviews having charge of special interests, America has reason for complacency. The interests of literature are well represented by such publications as the *Literary World* (1870); the *Bookman* (1895); *Current Literature* (1888); and *Good Literature* (1892). Economic and political science are represented worthily by *The Quarterly Journal of Economics* (1886) and the *Political Science Quarterly* (1886), emanating respectively from Harvard and Columbia Universities. A similar review, the *Journal of Political Economy*, was established in 1893 by the University of Chicago. *Guntton's Magazine*, established by George Guntton in 1896, is also an admirable periodical of this class. Advanced philosophy has the *Quarterly Monist* (1890), a Chicago publication, while conservatism and scholastic philosophy is represented by the *Philosophical Review* (1892). The interests of education are looked after by the *Educational Review* (1890); *Education* (1880); the *Boston Academy* (1886); the *American University Magazine*; the *American Teacher* (1876), and many others in the rapidly extending list of school and educational

periodicals. The magazine *Self Culture* (1894), a Chicago publication, may also be classed among the admirable periodicals devoted to the spread of broad education and popular enlightenment.

Religious periodicals have multiplied with almost marvellous rapidity in America. The latest edition of *Rowell's Newspaper Directory* credits this branch of current literature with 1,123 publications, inclusive of the different denominations and the various lines of esoteric investigation and so-called progressive thought. Among the periodicals representing conservative theology may be mentioned the *Andover Review*; *Christian Literature* (1889); the *Preachers' Magazine* (1890); *Church Union* (1873); *Missionary Review of the World* (1887); and *Church Building Quarterly* (1883). Progressive theology is represented by a number of well-written periodicals, among which may be named the *New World* (1892); *New Church Review* (1876); and the *Homiletic Review* (1876). Occult literature finds place in a number of recent periodicals, among which are *Occultism* (1893); *Metaphysical Magazine* (1895); and the *Rostrum* (1889). The *International Journal of Ethics* discusses its special theme with force and dignity; and of the same class is the *Conservator* (1890). Among historical periodicals of recent origin may be named the *Colonial Magazine* (1895); *Spirit of '76* (1894); *Magazine of the Daughters of the Revolution* (1893); *Putnam's Historical Magazine* (1890); *Current History*, a quarterly established in 1891 in Buffalo, N. Y.; and the *American Historical Register* (1894), of Philadelphia. A unique contribution to this class, also, is *Historia*, a monthly juvenile magazine, established in 1892 in Chicago.

In 1817 America possessed but a single scientific periodical. To-day every department of science and art has its special organs. Among the periodicals devoted to the higher branches may be mentioned the *Art Amateur*, established in New York (1879) by Montague Marks. The *Art Interchange* (1864) also discusses the various themes within its province with cleverness. Music is looked after ably by *The Étude*, established by Theodore Presser (1883) in Philadelphia, and by W. S. B. Mathew's *Music*, established in Chicago in 1891. Medicine and hygiene have the *American Medical Review* (1895); the *North American Practitioner* (1888); the *Medical Tribune* (1888); the *Polyclinic* (1893); and a host of others. Electricity is discussed intelligently by a number of periodicals, among which may be named *Electric Power* (1889); *Electrical Engineering* (1892); and *Electrical Progress* (1881). Among the eclectic magazines which have attained wide circulation is the *Review of Reviews*, of which an American edition was established in New York by Albert Shaw in 1889. One feature of this magazine is the index to current periodicals.

The number and excellence of the special publications devoted to America's rapidly developing industrial and commercial interests is one of the marked features of the recent periodical literature. Every department of business has a number of organs which are conducted with creditable dignity and intelligence. Among the magazines of this character may be mentioned the *American Silk Journal* (1882); *Business Journal* (1895); the *Leather Manufacturer* (1890); *Lumber* (1883); *Machinery* (1894); *Street Railway Journal* (1884); *Trade Mark Record* (1882); *Stone* (1888); *Shoe Budget* (1895); *Textile World* (1888); *American Jeweller* (1882); *Furniture* (1889); the *Inland Printer* (1883); and the *Horseless Age* (1895) in the interest of motor vehicles. These publications are representative of a class of trade-journals which have attained much influence in commercial circles, and which cover numerous branches of human industry.

The number of periodicals specially designed for women has kept full pace with other light literature. The *Ladies' Home Journal* (1883); *The Ladies' World* (1879); the *Ladies' Home Companion* (1873); *Womankind* (1878); and *House and Home* (1884) are among these. Among the juvenile periodicals may be named *Babyhood* (1884); *St. Nicholas* (1873); the *Argosy* (1882); *Pansy* (1873); and the *Knapsack* (1892).

In the foregoing consideration of recent American periodicals only monthlies or quarterlies have been included. The rapid movement of the times has reduced the weeklies to the plane of the newspaper press, so far as literary

merit or dignified treatment of subjects is concerned, as to place them outside the limit of serious literary work. And even if the weeklies were free from the defects of the ephemeral press, their number is so vast, and their scope so great, that they could not be considered here.

C. A. DANIELL.

MAGDALENA RIVER. See COLUMBIA, Vol. VI, p. 153.

MAGDALENE, MARV, a woman of the town of Magdala, near Tiberias (hence her name), out of whom Jesus cast seven devils. She first appears (Luke viii: 2) among the women who "ministered unto him of their substance." She was present at the crucifixion, and was one of those who went on the first Easter morning to the sepulcher with sweet spices. To her Christ first showed himself after His resurrection. For some unknown reason she has generally been considered the same as the woman who anointed our Lord's feet with ointment and wiped them with her hair (Luke vii: 36-50), but there is no evidence to substantiate the assumption. A popular, though probably erroneous impression, ascribes to her an immoral life previous to her meeting Jesus; hence the name Magdalene has been given to penitent profligate women as a class. As such she figured in the art and traditions of the middle ages. According to the mediæval legend, after the Ascension, the Virgin Mary, Salome and Mary Magdalene embarked in a small boat on the Mediterranean Sea to escape persecution in Judæa, and, after a miraculous voyage, landed in southern France. The Magdalene retired to St. Baume, and there spent the remainder of her life in prayer and penance. This story led to the search for her body, which was found, it was claimed, by the monks of Vezelai. The result was that Vezelai became a place of pilgrimage and very rich, the King, St. Louis, himself paying homage at the shrine; but, unfortunately for Vezelai, the search was prosecuted with equal zeal and success by Prince Charles of Salerno at St. Baume. Vezelai in consequence lost much of its credit, although its claim was upheld by the Pope.

MAGDALENE ISLANDS. See QUEBEC, Vol. XX, p. 165.

MAGDEBURG CENTURIES. See CHURCH HISTORY, Vol. V, p. 765.

MAGDEBURG HEMISPHERES. See HYDRO-MECHANICS, Vol. XII, p. 444.

MAGEE, WILLIAM CONNOR, archbishop of York; born in Cork, Ireland, Dec. 17, 1821. He graduated from Trinity College, Dublin, and in 1844 took orders. In 1850 he was appointed joint incumbent, and shortly after sole incumbent, of the Octagon Chapel, Bath. In 1860 he succeeded Dean Goulburn as minister of Quebec Chapel, London; and in Feb., 1861, he was appointed to the rectory of Enniskillen by the University of Dublin. In 1864 he was appointed dean of Cork; in 1868 Bishop of Peterborough; and in March, 1891, Archbishop of York. He took an active part in the House of Lords in opposing the disestablishment of the Irish Church. Died in London, May 5, 1891. See *Life* by Canon MacDonell (2 vols., 1896).

MAGELLANIC CLOUDS. See ASTRONOMY, Vol. II, p. 821.

MAGENDIE, FRANÇOIS, a French physiologist; born at Bordeaux, Oct. 15, 1783. He studied at Paris; in 1819 he became a member of the Academy of Sciences, and in 1831 professor of anatomy in the Collège de France. He was the founder, and for ten years editor of the *Journal of Experimental Physiology*. He practiced vivisection extensively, and by this and other means of observation made important additions to the knowledge of nerve physiology, the veins and the physiology of food. Among his works are *Elements of Physiology* (1816-17); *Lessons on the Physical Phenomena of Life* (1836-42); *Lessons on the Functions and Maladies of the Nervous System* (1839); and *Lessons on the Blood* (1839). He died in Paris, Oct. 7, 1855.

MAGENTA, BATTLE OF. See AUSTRIA, Vol. III, pp. 138, 139.

MAGERÖ, an island off the north coast of and belonging to Norway, on which is the most northerly point of land in Europe. This is not the so-called North Cape, but a point a little to the west, and about a quarter of a mile further north, called Knioskjörrade. Magerö is 22 miles long and 15 broad, and is deeply indented by bays. A few Norwegians and Laplanders live there.

MAGGOTS. See DIPTERA, Vol. VII, pp. 256, 257.

MAGI. See PERSIA, Vol. XVIII, p. 564; EPIPHANY, Vol. VIII, p. 483.

MAGILUS, a remarkable gasteropod of the family *Tubulibranchiata*, found on the coral reefs of warm eastern seas. The young animal settles on the growing madrepores at the obvious risk of being gradually surrounded and smothered. This is avoided, however, by an entire change in the form of the shell, which is diverted from its original spiral type, and grows by constant accretions into a long, irregular tube, the growth of which keeps pace with that of the coral.

MAGINN, WILLIAM, an Irish author, born at Cork, Nov. 11, 1793. He was educated at Trinity College, Dublin, where he won a brilliant reputation for precocious scholarship; taught in Cork for ten years; and in 1823 removed to London to pursue a life of letters. His first contributions to *Blackwood's Magazine* appeared in 1819, and from that date, for nine years, scarcely a number appeared without an article from his pen. In 1824 Murray started the short-lived *Representative*, a daily newspaper, and Maginn was sent to Paris to act as foreign correspondent. In 1828 he joined the staff of the *Standard*, and was one of the originators of *Fraser's Magazine* in 1830. He also contributed numerous papers to the *Quarterly Review*, to *Bentley's Miscellany*, and to *Punch*. His writings were characterized by learning and wit. They consist of two forgotten romances; his *Shakespeare Papers*; *Homeric Ballads* (1849); and numerous other works. His critical and miscellaneous essays were collected in the United States and edited by Dr. R. S. Mackenzie (1855-57.) Maginn had great ability, but was extravagant and intemperate, and during the latter

part of his life was frequently imprisoned for debt. He died in poverty at Walton-on-Thames, Aug. 21, 1842.

**MAGNA CHARTA.** See ENGLAND, Vol. VIII, pp. 306-308.

**MAGNA GRÆCIA.** See GRÆCIA, Vol. XI, p. 30.

**MAGNESIA.** See MAGNESIUM. Vol. XV, p. 218.

**MAGNETIC CONCENTRATION OF ORES.** See IRON AND STEEL, in these Supplements.

**MAGNETIC SUSCEPTIBILITY.** See ELECTRICITY, § 58, in these Supplements.

**MAGNETISM, TERRESTRIAL.** See METEOROLOGY, Vol. XVI, pp. 159, 184.

**MAGNETO-MOTIVE FORCE.** See ELECTRICITY, § 65, in these Supplements.

**MAGNETS.** See MAGNETISM, Vol. XV, pp. 274, 275.

**MAGNOLIA**, a town and the capital of Columbia County, southwestern Arkansas, 32 miles S.W. of Camden, on the St. Louis Southwestern railroad. It is in a well timbered and watered region. It is a cotton-shipping point, and has saw and grist mills. Population 1890, 1,486; 1900, 1,614.

**MAGNUSEN, FINN**, an Icelandic archæologist; born at Skalholt, Iceland, Aug. 27, 1781. After being educated at the University of Copenhagen, he became a lawyer in Iceland in 1803, but in 1815 was appointed professor of northern antiquities, and afterward keeper of the archives in Copenhagen. He prepared a dictionary of Scandinavian mythology, and a full exposition of its system. But his chief work is a translation of the older *Edda*, which he published with abundant commentaries in 1821-23. All his writings indicate excellent judgment and extensive learning. He died in Copenhagen, Dec. 24, 1847.

**MAGOG.** See GOG AND MAGOG, Vol. X, p. 738.

**MAGRUDER, JOHN BANKHEAD**, an American Confederate general; born Aug. 15, 1810, in Winchester, Virginia. He graduated at West Point in 1830; served in the Mexican War as captain, and obtained the brevets of major and lieutenant-colonel. When the Civil War broke out he resigned his commission and joined the rebel army, obtaining the rank of brigadier-general. When McClellan landed his forces on the peninsula, he found Magruder in defense of the fortifications at Yorktown with but 5,000 men. McClellan with 58,000 men besieged the place. When works had been constructed, and a general attack was about to be made, Magruder withdrew with all his men and munitions. This delay (it was almost a month) probably saved Richmond, for in the interval Johnston had been able to concentrate his troops. Magruder afterward served in almost all the battles of the peninsula campaign, and was raised to the rank of major-general. In 1862 he took command of the department of Texas, and in 1863 recaptured Galveston, and raised for a time the blockade of the port. At the end of the war he went to Mexico and

served in the imperial army until the overthrow of Maximilian, and afterward lectured in the United States on *Mexico*. He died at Houston, Texas, Feb. 19, 1871.

**MAGYAR LANGUAGE AND LITERATURE.** See HUNGARY, Vol. XII, pp. 374-380.

**MAGYARS**, a race. See HUNGARY, Vol. XII, pp. 365-367.

**MAHĀBHĀRATA.** See SANSKRIT, Vol. XXI, pp. 281-283.

**MAHAFFY, JOHN PENTLAND**, an Irish educator; born near Vevay, Switzerland, Feb. 26, 1839. He was educated in Germany and at the University of Dublin, graduating at the latter institution in 1859; was appointed precentor of the university chapel in 1867; professor of ancient history in 1871; Donnellan lecturer in 1873. He was decorated with the gold cross of the Order of the Saviour by the King of Greece in 1877. Professor Mahaffy published a great number of works on philosophy and ancient history. Among them are *Kant's Critical Philosophy for English Readers* (1872-74); *Social Life in Greece* (1874); *Rambles and Studies in Greece* (1877); *A History of Classical Greek Literature* (1880); *Descartes* (1880); and *Alexander's Empire in the Story of the Nations* series (1887). He edited *Duruy's Roman History*, and translated Kuno Fischer's *Commentary on Kant*.

**MAHAN, ASA**, an American clergyman and educator; born in Vernon, New York, Nov. 9, 1800. He graduated at Hamilton College in 1824, and at Andover Theological Seminary in 1827; held pastorates in Pittsford, New York (1829-31), and in Cincinnati (1831-35); president of Oberlin College (1835-50), of Cleveland University (1850-55); pastor at Jackson, Michigan (1855-57), at Adrian, Michigan (1857-60); president Adrian College (1860-71); after the latter year resided in England until his death. He advocated the religious doctrine known as "Perfectionism," and published on the subject, *Scripture Doctrine of Christian Perfection* (1839). He was also the author of *Doctrine of the Will* (1846); *Moral Philosophy* (1848); *Logic* (1857); *Theism and Anti-Theism* (1872); *Critical History of Philosophy* (1883); and other philosophical works. He died in Eastbourne, England, April 4, 1889.

**MAHAN, ALFRED THAYER**, an American naval officer, son of DENNIS HART MAHAN (q. v., below); born at West Point, N. Y., Sept. 27, 1840; graduated at the United States Naval Academy (1859); during the Civil War served in the South Atlantic and Gulf squadrons; professor at the naval academy (1877-80); president of the naval college at Newport (1886-89 and 1890-93); commander of the *Chicago* in the European squadron in 1893. He wrote *The Influence of Sea Power upon History*,



CAPTAIN A. T. MAHAN.

1660-1783 (1890); *The Life of Admiral Farragut* (1892); *Influence of Sea Power upon the French Revolution and Empire* (2 vols., 1894), extensive works, accepted generally as authoritative and exhaustive; also a *Life of Nelson* (2 vols., 1897); and *The Interest of the United States in Sea Power* (1898). He was retired at his own request, Nov. 17, 1896; but was a member of the Naval Advisory Board during the war with Spain in 1898. At present (1899) he is writing a history of the War of 1812-14.

MAHAN, DENNIS HART, an American soldier and instructor; born in New York city, April 2, 1802; moved with his parents to Virginia in 1820; graduated with honors at West Point in 1824; assistant professor of mathematics and engineering at the academy (1824-26); spent four years (1826-30) in the study of military science abroad; in 1832-71 professor of civil and military engineering at the United States Military Academy. Among his works are *An Elementary Course of Military Engineering* (1847); *Industrial Drawing* (1853); and *Fortification-drawing and Stereotomy* (1865). He also edited *Moseley's Mechanical Principles of Engineering and Architecture* (1856-69). He drowned himself in the Hudson near Stony Point, Sept. 16, 1871, while suffering from an attack of temporary insanity.

MAHANNOY CITY, a borough of Pennsylvania, is in the anthracite-coal region, and has about twenty collieries and an active trade with the other coal-mines in the neighborhood. Population 1900, 13,504. See MAHANNOY CITY, Vol. XV, p. 285.

MAHAYANA. See LAMAISM, Vol. XIV, p. 229.

MAHDI, EL, the title assumed by the pretender Mohammed Ahmed of the Soudan, in Egypt, who, instigated by the brotherhood of Sid-es-Senoussi, of which he was a member, proclaimed a holy war in 1880. Mohammed Ahmed was born in Dongola, Nubia, in 1842. He studied Mohammedan theology, was for a time connected with the Egyptian civil service, later a slave-trader and merchant and finally a dervish or monk. In 1882 he proclaimed himself El Mahdi (the Messiah), raised an army in Soudan, where Egyptian misrule had caused considerable ill-feeling, and in September, 1883, seized El Obeyd, the chief city of Kordofan, and made it his capital. On Nov. 5, 1883, he totally annihilated the Egyptian army of ten thousand sent against him under Hicks Pasha, and in 1885 took Khartoum, where General Gordon, whom the British government had sent to effect the pacification of the Soudan, was killed. El Mahdi died of smallpox June 25, the same year. For the origin and meaning of the title, see Vol. XV, p. 285.

MAHE. See SEYCHELES, Vol. XXI, p. 725.

MAHMUD II OR MAHMOUD, AND HIS SULTANATE. See TURKEY, Vol. XXIII, pp. 649, 650.

MAHOMET. See MOHAMMEDANISM, Vol. XVI, pp. 545-561.

MAHONE, WILLIAM, an American public man and soldier; born in Southampton, Virginia, Dec. 1, 1826; graduated at the Virginia Military Institution in 1847, and engaged in civil engineering. In 1861 he joined the Confederate army, took part in the capture of Norfolk navy-yard, and engaged in

nearly every battle of the peninsula campaign, on the Rappahannock, and in the campaign around Petersburg, where his bravery in repelling the Union attack after the mine explosion, won for him the sobriquet of "The Hero of the Crater." He won the reputation of a fearless fighter, became brigadier and major-general, and commanded a division in A. P. Hill's corps. After the war he returned to engineering, and became president of the Norfolk and Tennessee railroad. He entered politics about

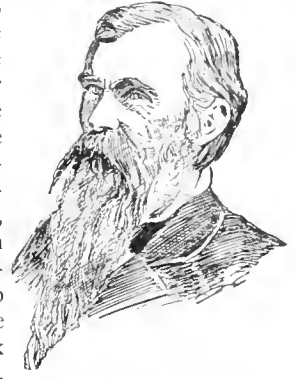

GEN. WILLIAM MAHONE.

1878, and became the leader of the party which aimed at the "readjustment" (a mild equivalent for repudiation) of the state debt of Virginia. In 1880 he was elected United States Senator, and served from March, 1881, to 1887, but was defeated for re-election. Died in Washington, District of Columbia, Oct. 8, 1895.

MAHOPAC, a village and summer resort of Putnam County, southeastern New York, 48 miles N. of New York City, on the New York Central and Hudson River railroad and on Mahopac Lake. Situated here are a dozen large hotels and boarding-houses, which in summer are crowded with visitors. Mahopac Lake is about three miles in diameter, incloses some picturesque islands and is surrounded by beautiful hilly scenery. Permanent population 1890, 409.

MAHWA BUTTER. See OILS, Vol. XVII, p. 747.

MAIDENHAIR OR GINGKO TREE. See ARBORICULTURE, Vol. II, p. 320.

MAID OF KENT. See BARTON, ELIZABETH, Vol. III, p. 404.

MAIGNAN, ALBERT, a French painter; born Dec. 15, 1844, in Beaumont, Sarthe. He studied art under J. Noël and Luminais; in the salon of 1879 received a first-class medal; was decorated with the ribbon of the Legion of Honor in 1883. At Philadelphia in 1876 he exhibited *Helen at the Fountain* and the *Sentinel*, and received a medal. His *Departure of the Norman Fleet for the Conquest of England* (1874) and *Dante Meeting the Countess Matilda* are in the Luxembourg. *Louis IX Consoling a Leper* was exhibited in 1878; in the Metropolitan Museum at New York is his *Assault on Pope Boniface VIII at Agani*.

MAIGRE-FISH (*Sciæna aquila*), a large fish common in the Mediterranean and along the eastern coasts of the Atlantic. It reaches a length of six feet, and is valuable as a food-fish. The ear-bones are often worn as charms and lucky-stones by superstitious people. There is an American species.

MAIKOFF, APOLLON NIKOLAEVITCH. See RUSIA, Vol. XXI, p. 109.

MAILING-MACHINE. The machines used for addressing newspapers or periodicals for mailing are popularly known by this name, though more

properly called addressing-machines. Two types are in common use, one of which prints on the paper or periodical itself, while the other pastes on prepared printed slips or labels bearing the addresses. The direct-printing machine is mounted on a form of printer's galley, bearing the type set for a number of addresses, a short, blank space being left between each address. The type on the galley is inked by hand first, and a newspaper, folded or wrapped ready for delivery, is inserted. A lever being depressed, the first address on the galley is printed on the newspaper, while a ratchet mechanism moves the printing-device to the next address, which is printed on the next newspaper in the same manner. There has also been manufactured a mailing-machine of the direct-printing type, which prints from wooden blocks, the addresses appearing on the paper in white letters, surrounded by a black background.

Machines of the label-sticking type are made very small, and are hung on the left arm of the user. A strip of addresses, having been printed previously, is fed into the machine and run over a roller, which covers the back of the strip with wet paste. The mailing-machine is rested upon the top paper of a pile of newspapers and the address-slip being projected a short distance, the pressing of a small lever cuts off one address and pushes it down on to the newspaper, where it adheres in the form of a label. The machine is then raised, the addressed paper removed, and the next paper can be addressed in the same manner. With this machine several thousand papers have been addressed in an hour.

C. H. COCHRANE.

MAINE. The population of Maine, according to the census of 1900, was 694,466, that of 1890



SEAL OF THE STATE OF MAINE.

was 661,086, the percentage of increase being 5.0. The relative position of the state was 30, a loss of three since 1880. The density of population in 1890 was 22.11 to the square mile, the smallest of any of the North Atlantic division of states; 130,346 of the population resided in the eight cities of the state, constituting 19.72 per cent of the entire number of people. The number of males was 332,590, the number of females 328,496. The percentage of native-born citizens was 88.06; of foreign-born 11.94. The number of negroes in the state was 1,190, a decrease of 261 within the preceding ten years. In 1889 the state had 171,777 acres devoted to the cereals, on which were produced 4,888,734 bushels. The greatest area of this was in oats, over 70 per cent of the entire amount being given up to that cereal, 121,612 acres having been cultivated, on which 3,668,909 bushels were raised. The total number of farms in Maine was

62,013, a decrease of almost 2,000 since 1880. The average size was given at 100 acres, the total acreage being 6,179,125. Of this, 50.73 per cent was unimproved, the area of improved lands in farms also having decreased in the decade. The total valuation of lands, fences, buildings, machinery, implements and live-stock was estimated at \$122,347,283, the value of farm products at \$22,049,220. The number of horses was 109,156; mules, 278; neat cattle, including 157,278 milch cows, 299,110; swine, 91,297; and sheep, 370,484, from which 1,864,009 pounds of wool were sheared.

The assessors' returns for 1894 show the number of polls in the state to have been 178,676; the value of the real estate, \$232,038,232; the value of personal property, \$74,848,812; the value of all property in the state subject to taxation, \$324,478,321. The rate of taxation for the year named was  $2\frac{1}{2}$  mills on the dollar; the total receipts from all sources was \$1,650,972; the total expenditures,



STATE CAPITOL, AUGUSTA.

\$1,528,493. The liabilities of the state in 1895 were as follows: Bonded debt, \$2,253,000; trust funds held by the state on which no interest is paid, \$748,331. The bonded indebtedness was reduced during the year by \$50,000. The total value of the live-stock of the state was \$14,020,398. The railroads of the state paid in taxes for the year named, \$182,890; the telegraph and telephone companies, \$12,037; the express companies, \$5,358; the loan and building associations, \$942; the savings banks, \$398,208.

The chief cities of the state are Portland (50,145), Lewiston (23,761), Bangor (21,850), Biddeford (16,145), Auburn (12,951), Augusta (11,683), Bath (10,477), Waterville (9,477), Rockland (8,150), Calais (7,655), and Westbrook (7,283). The area of the state is, approximately, 29,895 square miles, the average number of persons to the square mile being in 1900 23.2. Portland is the only town in the state which has a population exceeding 25,000.

The school report for 1894 shows the number of persons of school age, 4 to 21, to have been 206,504, of whom 135,815 attended school during the year. The average length of the school year was 24 weeks and one day. The number of teachers employed



was 7,421, the amount of whose wages was \$1,067,-482. The whole number of schools was 4,706; the estimated value of all school property, \$3,917,120. The amount expended for free text-books was \$56,-682; the total expenditures in behalf of the schools, \$1,557,862. State normal schools were maintained at Farmington, Castine and Gorham, the average attendance per term being 167, 126 and 88 respectively. The institutions of higher education are mentioned at length in Vol. XV, pp. 297-302. The Baptist Church controls Colby University, at Waterville; the Free Baptist Church, Bates College, at Lewiston; and the Congregational Church, Bowdoin College, at Brunswick. The Westbrook Seminary for Women, a Universalist institution, at Deering, and Maine Wesleyan Female College, controlled by the Methodist Episcopal Church, located at Kent's Hill, are both flourishing, and have libraries of 3,000 and 7,000 volumes, respectively.

The report of the state librarian for 1894 shows 34 free public libraries, with more than 140,000 volumes; 21 state, county and college libraries, with more than 150,000 volumes; and 44 libraries at which a fee is charged for the use of books, which had about 135,000 volumes. The report states that nearly 100 libraries failed to send in returns and are not included in the above.

The state prison, located at Thomaston, in 1894 had 146 as an average daily number of convicts, the whole number since the establishment of the prison being 3,233. The bulletin of the Department of Labor, issued in July, 1896, showed the value and kinds of labor performed by the convicts of the Maine state prison to have been as follows for the year 1895: Carriages, wagons and sleighs, \$14,590; harnesses, \$9,572; brooms and brushes, \$18,764; and furniture, \$900. The work was done under the public-account system. The reports from the jails of the state for 1895 show that 6,176 persons were confined during the year.

At the close of 1894 the Maine Insane Hospital, located at Augusta, had 680 patients under treatment. The disbursements were about \$180,000, and the patients produced farm products during the year amounting in value to more than \$15,000.

Nov. 30, 1894, there were 140 boys in the state reform school at Cape Elizabeth, the cost of whose maintenance for the year had amounted to \$27,000. The school was established over forty years ago, and has been conducted as a "school for the instruction, employment and reform of juvenile offenders," and as such it has proved successful.

For 1894 the state bank examiner reported 51 savings banks in Maine, which held deposits to the amount of \$54,531,223, their total resources being more than \$3,000,000 in excess of their deposits. The number of national banks was 84, with combined capital of more than \$12,000,000, and surplus of about \$5,000,000. There were 15 trust and banking companies, whose combined capital stock was \$1,205,400, and their total liabilities and resources amounted to \$5,835,807; 30 building and loan associations reported 7,894 shareholders, 2,332 borrowers, 2,711 loans and dividends during the year of \$130,537.

The report of the railroad commissioner for 1895 showed 1,626 miles of operated track, a gain for the year of 110 miles. The gross transportation earnings for the year were \$155,042, the gross operating expenses \$109,633, leaving an income from operation of \$45,408.

The report of the Commissioner of Fisheries for 1895 showed that there were enrolled in the customs districts of the state 437 vessels, which are engaged exclusively in the fisheries, and in addition there are employed in the shore fisheries more than 6,000 fishing-boats, with a valuation of not less than \$500,000. The sea and shore fisheries of the state give employment to upward of ten thousand people, and involve an investment in apparatus and cash capital of \$3,000,000.

Below are given the appropriations made by the legislature of 1895 for benevolent and educational institutions:

For pensions, \$140,000; Eastern Insane Hospital, \$150,000; General Hospital, \$15,000; Eye and Ear Infirmary, \$10,000; Bangor General Hospital, \$10,000; Central General Hospital (conditionally), \$20,000; Penobscot Indians, \$16,164; Passamaquoddy Indians, \$16,080; Cattle Commission, \$10,000; State Library, \$8,000; Maine Insane Hospital, \$14,000; State College, \$40,000; Farmington Normal School, \$20,000; Reform School, \$50,500; Military and Naval Orphan Asylum, \$19,500; State Prison, \$19,000; School for the Deaf, \$16,000; Industrial School, \$14,000; Children's Aid Society, Belfast, \$3,000.

The granite product of the state for 1893 was estimated at \$1,274,594, the value of the slate at \$139,-200 and the limestone at \$1,474,695.

In 1894 there were 493 Passamaquoddy Indians in Maine, the members of the Penobscot tribe numbering 390. They are engaged largely in agricultural pursuits and in the business of guiding tourists and summer visitors, who were estimated to number 175,881 for the year mentioned, and to have expended within the state the sum of \$2,731,-431.

The following is a full list of the governors of Maine, with the dates of service of each: William King, 1820-21; William D. Williamson, 1821-22; Albion K. Paris, 1822-27; Enoch Lincoln, 1827-29; Nathan Cutler, 1829-30; Jonathan D. Hutton, 1830-31; Samuel E. Smith, 1831-34; Robert P. Dunlap, 1834-38; Edward Kent, 1838-39; John Fairfield, 1839-40; Edward Kent, 1840-41; John Fairfield, 1841-43; Edward Kavanaugh, 1843-44; Hugh J. Anderson, 1844-47; John W. Dana, 1847-50; John Hubbard, 1850-53; William G. Crosby, 1853-55; Anson P. Morrill, 1855-56; Samuel Wells, 1856-57; Hannibal Hamlin, 1857; Joseph H. Williams, 1857-58; Lot M. Morrill, 1858-61; Israel Washburn, Jr., 1861-62; Abner Coburn, 1862-64; Samuel Corey, 1864-67; Joseph L. Chamberlain, 1867-71; Sidney Perham, 1871-74; Nelson Dingley, Jr., 1874-76; Selden Connor, 1876-79; Alonzo Gairolon, 1879-80; Daniel F. Davis, 1880-81; Harris M. Plaisted, 1881-83; Frederick Robie, 1883-87; Joseph R. Bodwell, 1887; Sebastian S. Marble, 1887-89; Edwin C. Burley, 1889-93; Henry B. Cleaves, 1893-97; L. Powers, 1897. See also MAINE, Vol. XV, pp. 297-302.

MAINE, SIR HENRY JAMES SUMNER, an English jurist; born Aug. 15, 1822. After graduating at

Pembroke College, Cambridge, in 1844, he became professor of civil law there; was afterward reader on jurisprudence at the Middle Temple, London, until 1862, when he went to India as law member of the council. In 1870 he became professor of comparative jurisprudence at Oxford, and in 1877 master of Trinity Hall, Cambridge. His most important works are *Ancient Law: Its Connection with the Early History of Society* (1861); *Village Communities in the East and West* (1871); *The Early History of Institutions* (1875); and *Popular Government* (1885). One of the fundamental ideas in Sir Henry Maine's theory of the rise of institutions is that patriarchal power was the germ from which society developed. He died in Cannes, Feb. 3, 1888.

"MAINE," THE, a battleship of the second class, of the United States navy, built at Brooklyn Navy Yard, and launched in 1890. She was of 6,648 tons displacement; had engines of 9,000 indicated horse-power; carried four 10-inch, six 6-inch, twelve 6-pounder, and four 1-pounder rapid-fire, and four Gatling guns, and cost \$2,500,000. On the 24th of January, 1898, under command of Captain Charles D. Sigsbee, she was ordered to Havana (see UNITED STATES, *post*, pp. 3000*d*-3000*e*), where at 9:40 P. M. on the 15th of February, she was blown into fragments by an explosion. Most of her crew were below, and 266 of them were killed or drowned outright, or received injuries from which they died later. Of this number two were officers. Assistance in saving the survivors was immediately rendered by the Spanish warship *Alfonso XII*, and by other ships in the harbor, while the three remaining boats of the *Maine* landed as many as they could pick up. A naval court of inquiry commenced an investigation at Havana on February 26th, and after twenty-three days' labor transmitted its report to the President, who communicated the same to Congress on the 28th of March. The report in substance found that the explosion was caused by a submarine mine, which in turn caused the partial explosion of two or more of the magazines; that no fault, negligence, or lack of discipline on the part of the ship's company contributed to the disaster; and that the court was unable to fix the responsibility for the explosion on anyone. The Spanish authorities also held an inquiry, and reported that the explosion was manifestly from internal causes. The Spanish proposal to settle the question by arbitration was rejected by the United States, and in all probability the truth will forever remain a secret. The war which ensued between the United States and Spain, while not actually brought about by this occurrence, was undoubtedly hastened and embittered by it.

MAINE STATE UNIVERSITY was founded in 1865 by act of the legislature, and located at Orono, 8 miles N. of Bangor. It is non-sectarian, and offers eight courses of study, each requiring four years; viz., scientific, agricultural, civil engineering, mechanical engineering, electrical engineering, chemical, pharmaceutical, and a preparatory medical course. The ancient languages are not taught. Tuition fee, \$30 a year; room-rent free. Military drill is required. There are 17 buildings in all, the principal

of which are Wingate Hall, Oak Hall, Chemical Laboratory, and Coburn Hall. An agricultural experiment station is connected with the institution, which receives \$15,000 annually from the U. S. government. The endowment is \$230,817. In 1898 the income was \$89,443, and there were 43 instructors and 320 students. The library has 14,000 vols.

MAINOTES. See GREECE, Vol. XI, p. 84.

MAINTENANCE, in law, is an officious intermeddling in a suit by one having no interest therein, for the purpose of stirring up strife and prolonging litigation. The relations of master and servant or landlord and tenant between the maintainer and the plaintiff avoids the offense. Aid may also be rendered from motives of charity or to a relative. In most of the states of the Union, contracts growing out of maintenance are void, and the act is a misdemeanor punishable by fine or imprisonment, or both. In England the maintenance of the suit of another on a corrupt agreement to divide the fruits of the action is called champerty, and the contract is void.

MAIO ISLAND. See CAPE VERD ISLANDS, Vol. V, pp. 50, 52.

MAIPO OR MAIPU, a river of Chile, rising in the Andes, a little north of lat. 34° S., and flowing almost directly westward to the Pacific Ocean. Length, 155 miles. On a plain a little to the north of this river was fought the battle of Maipó, in which San Martín, at the head of the republican forces, completely defeated the Spaniards, April 5, 1818, a victory that secured Chilean independence.

MAIT OR MAT, the Egyptian goddess of truth. See EGYPT, Vol. VII, p. 718.

MAIZE OR INDIAN CORN. See MAIZE, Vol. XV, pp. 309-10; and AGRICULTURE, in these Supplements.

MAJOLICA. See POTTERY, Vol. XIX, p. 624.

MAJOR, in music. See TONE, in these Supplements; and MUSICAL SCALES, Vol. XVII, p. 80.

MAJOR, GEORGE (1502-74). See LUTHERANS, Vol. XV, p. 85; REFORMATION, Vol. XX, p. 336.

MAJOR, RICHARD HENRY, an English historian; born in London, Oct. 3, 1818. He was placed in charge of the maps and charts in the British Museum in January, 1844. He was honorary secretary of the Hakluyt Society from 1849 to 1858, and vice-president of the Royal Geographical Society from 1881 to 1884. He made valuable researches in the history and bibliography of the Columbian era of American history, and published works and edited maps and documents relating to that period. He died in Kensington, June 25, 1891.

MAJORCA. See BALEARIC ISLANDS, Vol. III, p. 227.

MAJORISTS. See MAJOR, GEORGE, *supra*.

MAKART, HANS, an Austrian painter, born in Salzburg, May 29, 1840. He studied under Piloty, at Munich. In 1879 he became professor of painting in the Vienna Academy. In 1876 his large picture of *Venice Doing Homage to Catherine Cornaro* was exhibited at the Centennial Exhibition in Philadelphia; now in the Berlin National Gallery. All his large canvases are brilliant in coloring, and some of his themes are sensuous. His *Diana's Chase* is in the Museum of Art, New York. Died Oct. 3, 1884.







D 000 379

